

CATALOGUE

Moto & Scooter
125 ET +

DISTRIBUTEUR FRANÇAIS
DEPUIS 1988



www.cgnfrance-pro.com



CGN
LE SENS DU DÉTAIL



DISTRIBUTEUR FRANÇAIS

DEPUIS 1988

Chers clients,

Bienvenue dans le monde passionnant de CGN, votre partenaire de confiance depuis 1988 pour toutes vos pièces détachées et accessoires dédiés aux deux-roues motorisés.

Entreprise familiale, CGN a su traverser les années en restant fidèle à ses valeurs fondamentales : l'engagement envers la qualité, l'innovation constante et un service client exceptionnel. Au fil des années, CGN s'est forgé une réputation solide et est devenue une référence incontournable dans le secteur du motorisé.

Notre capacité à nous adapter aux évolutions du marché et à anticiper les besoins de nos clients fait partie intégrante de notre ADN et nous sommes fiers de collaborer avec des marques renommées pour vous proposer un large choix de produits répondant à toutes vos exigences.

Parcourez notre nouveau catalogue avec enthousiasme, découvrez-y nos dernières nouveautés, et soyez assurés que nous serons toujours à vos côtés, prêts à vous offrir le meilleur des services et les meilleurs produits comme nous le faisons déjà depuis trois décennies.

Bonne lecture et merci pour votre confiance.

L'équipe CGN



PEFC™ 10-31-1980 / Certifié PEFC / pefc-france.org 

Ce produit est issu de forêts gérées durablement et de sources contrôlées. / pefc-france.org

Catalogue imprimé en France, compte tenu de l'évolution constante des produits, des techniques et de la réglementation, CGN se réserve le droit de modifier différents produits et leurs caractéristiques techniques indiqués dans ce catalogue, sans préavis.

Produits dans la limite des stocks disponibles. Photos et caractéristiques non contractuelles.

Sous réserve d'erreurs typographiques, d'impression ou d'omission. Impression : Offset5.

Crédits photos : CGN. Exécution : mleclair.fr - Nantes (44). Ne pas jeter sur la voie publique

/ VOS INFORMATIONS PERSONNELLES

Code client :

Commercial :

Nom :

Prénom :

Tél :

/ NOS COORDONNÉES



www.cgnfrance.com



167 Boulevard Salvador Allende
CS 50244 - 44801 St-Herblain Cedex



contact@cgnfrance.com



02 40 92 00 95



France : 02 40 92 04 88
Export : +33 (0)2 40 92 17 65

Du Lundi au Vendredi
8h30 à 12h30 / 14h00 à 17h00

/ RETROUVEZ-NOUS SUR NOS DIFFÉRENTS RÉSEAUX :



Une équipe à vos côtés !

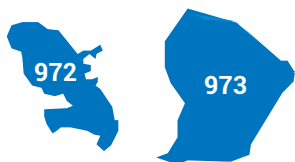
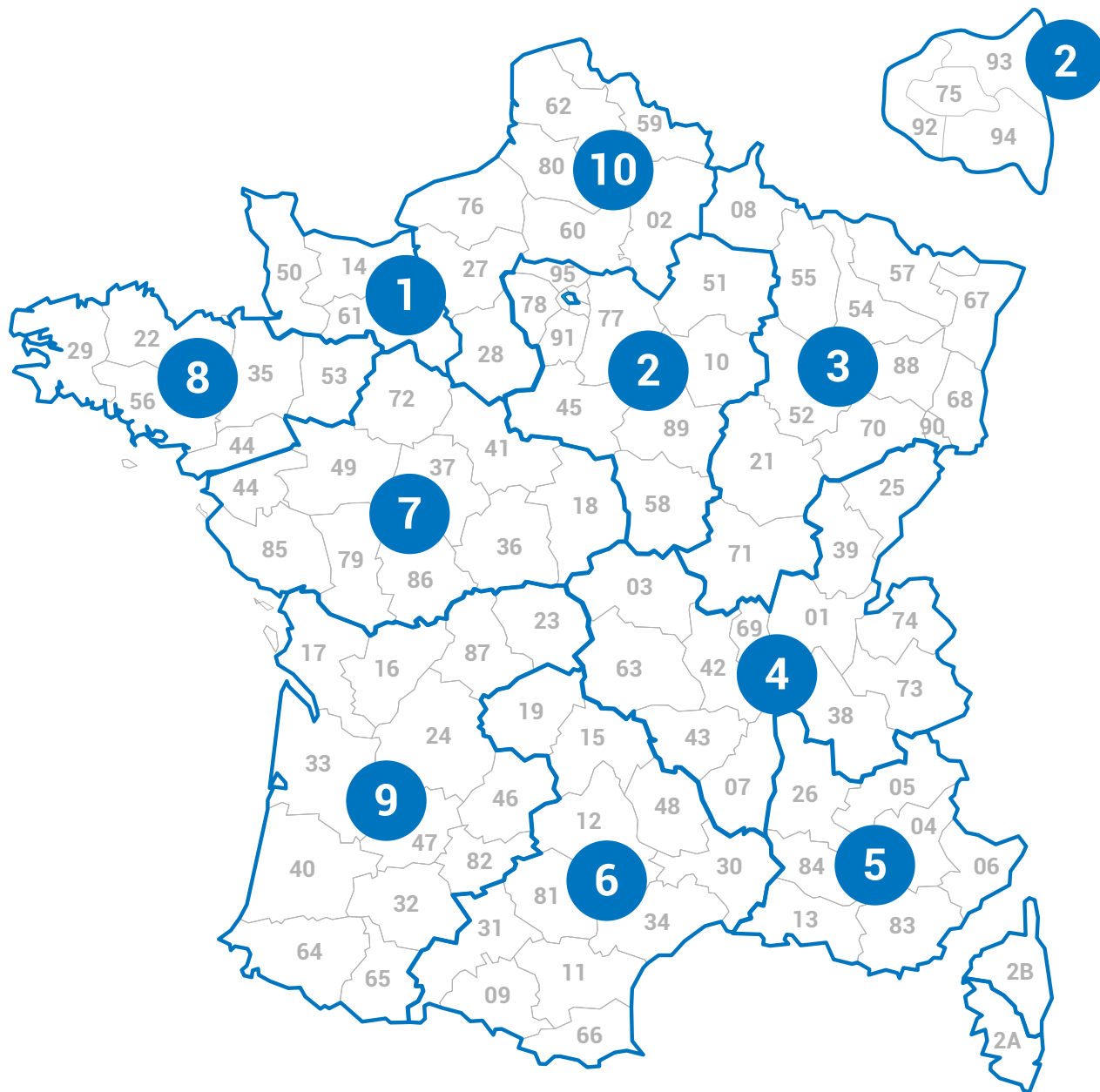

MARTINIQUE - GUYANE

Mireille POISSON

06 20 68 13 21

mireille.poisson@cgfrance.com



RÉUNION - MAYOTTE

Sébastien GASSON

06 16 09 54 58

sebastien.gasson@cgfrance.com



GUADELOUPE

Sébastien GASSON

06 16 09 54 58

sebastien.gasson@cgfrance.com

/ VOS COMMERCIAUX

**Guillaume
VERNIER**
Normandie

RESPONSABLE DES VENTES



1

06 80 43 46 49
guillaume.vernier@cgnfrance.com



**Philippe
PELLETIER**
Île-de-France
Loiret
Hauts-de-France



2

06 31 54 08 49
philippe.pelletier@cgnfrance.com



**Robert
LAURIA**
Est

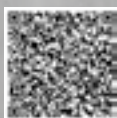

3

06 87 95 48 48
robert.lauria@cgnfrance.com



**Thierry
BOUGAREL**
Rhône-Alpes



4

06 73 10 16 01
thierry.bougarel@cgnfrance.com

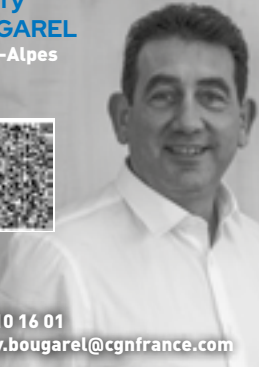

**Jérôme
SZAKOLCZAI**
PACA



5

06 31 16 86 47
jerome.szakolczai@cgnfrance.com



**Jérôme
LANCELOT**
Midi-Pyrénées



6

06 07 33 42 14
jerome.lancelot@cgnfrance.com



**Sébastien
MILLET**
Centre
Val de Loire



7

06 08 31 06 01
sebastien.millet@cgnfrance.com



**Philippe
LE GALLOUDEC**
Bretagne
Loire-Atlantique



8

06 72 22 05 13
philippe.legalloudec@cgnfrance.com



**Stéphane
BERTHON**
Sud-Ouest



9

06 73 09 41 94
stephane.berthon@cgnfrance.com



**Pierrick
DENDELEUX**
Hauts-de-France



10

06 31 16 91 13
pierrick.dendeleux@cgnfrance.com



**Débora
MORET**
EXPORT



06 18 47 84 94
debora.moret@cgnfrance.com



MOTEUR

CYCLE

PNEUMATIQUE

ATELIER

ACCESSOIRES

ÉLECTRICITÉ

FILTRATION

FREINAGE

TRANSMISSION

/ VOS TÉLÉCONSEILLERS

MOTORSÉ



PIÈCES PEUGEOT



SAV MOTORSÉ

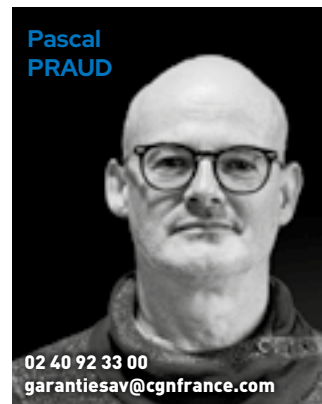

/ VOS CONTACTS ADMINISTRATIFS

STANDARD

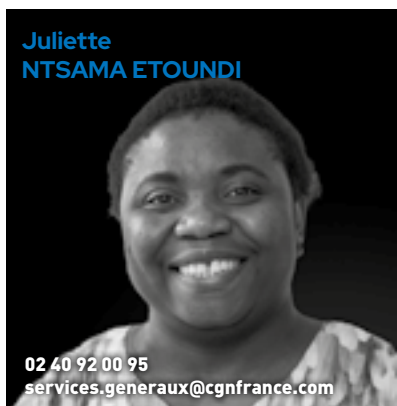

TRANSPORTS



SERVICE COMMERCIAL OUVERTURE COMPTE CLIENT



COMPTABILITÉ CLIENTS



ASSISTANCE INFORMATIQUE



RETOUR CLIENT



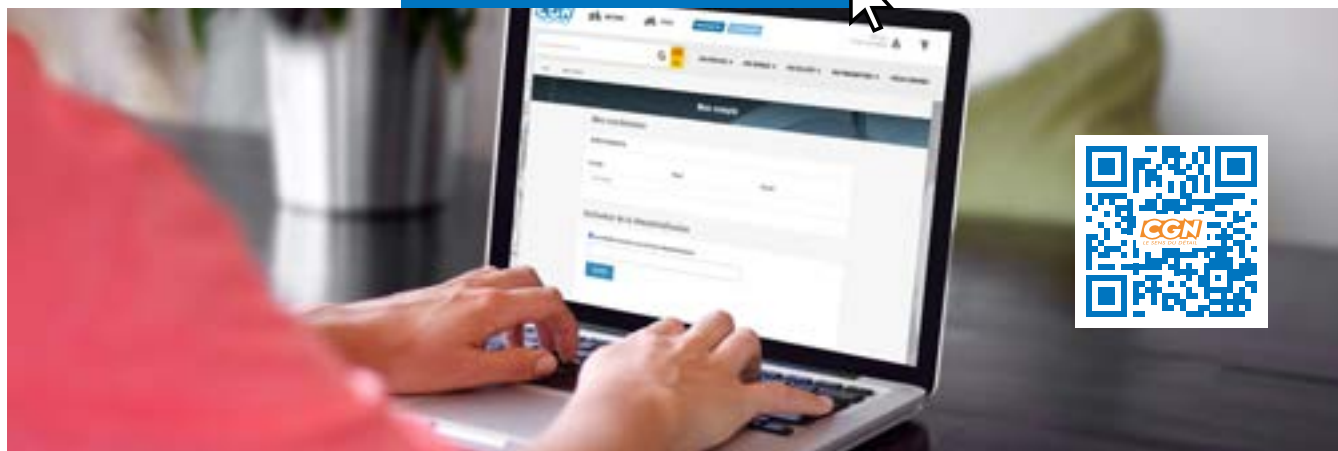

/ PAGES PRODUITS

POUR PASSER VOS COMMANDES, CONSULTEZ VOS TARIFS, ETC...

MOTO - Offres promotionnelles



NOUVEAUTÉS



MOTO - Recherche par éclaté

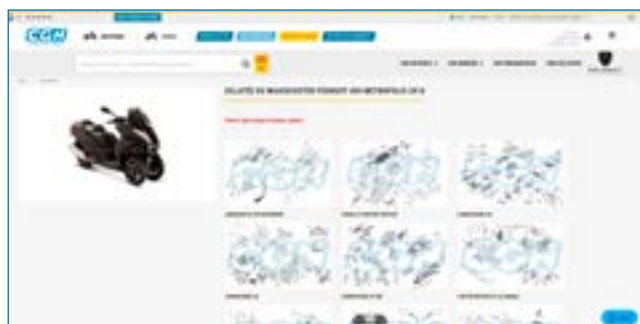

LE + - Recherche par véhicule

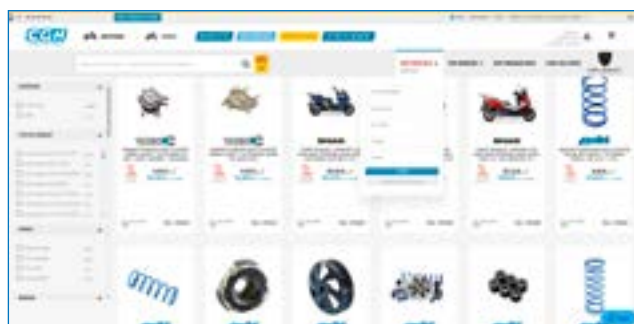

/ 50 000 produits, nouveautés, offres promotionnelles, suivi de commandes . . .

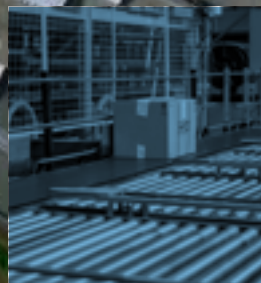

/ RÉFÉRENCIEMENT

- **+ de 50 000 références**
- **Les plus grandes marques du marché dont certaines en exclusivité**
- **10 marques propres pour répondre à tous les besoins**

/ RECHERCHE ET DÉVELOPPEMENT

- **Une veille permanente du marché**
- **Une équipe dédiée au développement**
- **Des innovations technologiques brevetées**

CGN
LE SENS DU DÉTAIL

/ LOGISTIQUE

- **10 000 m² de surface de stockage**
- **Un système de gestion d'entrepôt piloté par un logiciel WMS**

/ LIVRAISON

- **Livraison le jour même sur le secteur Grand Ouest : Départements 22/29/35/37 (Tours uniquement) 44/49/ 56/72/79/85/86**
Pour toutes commandes passées avant 9h30, livraison dans l'après-midi
- **Livraison en 24h en France métropolitaine pour toute commande passée avant 16h**

/ SOMMAIRE

MOTEUR	11	PNEUMATIQUE	321
/ ALLUMAGE / IGNITION	12	/ PNEUS SCOOTER / SCOOTER TYRES	322
/ CARBURATION / CARBURATION	27	/ PNEUS MOTO / MOTORCYCLE TYRES	342
/ CULASSE / CYLINDER HEAD	34	/ PNEUS CYCLO / MOPED TYRES	362
/ CYLINDRE / CYLINDER	36	/ CHAMBRE A AIR SCOOTER / INNER TUBE	368
/ JOINT / GASKET	38	/ CHAMBRE A AIR MOTO / INNER TUBE	371
/ ÉCHAPPEMENT / EXHAUST	40	/ CHAMBRE A AIR CYCLO / INNER TUBE	373
/ EMBIELLAGE / CRANKSHAFT	76	/ FOND DE JANTE CYCLO & MOTO / RIM LINER	375
/ EMBRAYAGE / CLUTCH	77		
/ ENGRENAGE / GEAR	79	ATELIER	377
/ REFROIDISSEMENT / COOLING	80	/ LUBRIFIANT / LUBRICANT	378
/ VARIATEUR / VARIATION	84	/ OUTILLAGE / TOOLS	438
		/ MAINTENANCE VEHICULE /	
CYCLE	93	VEHICLE MAINTENANCE	475
/ AUTOCOLLANTS / STICKERS	94	/ VISSERIE / NUTS AND BOLTS	488
/ DÉCORATION / DECORATION	102	/ IMMATRICULATION / NUMBER PLATES	492
/ SELLE / SADDLE	106		
/ COMPTEUR / SPEEDOMETER	107	ACCESSOIRES	501
/ CÂBLE COMPTEUR / SPEEDOMETER	110	/ ACCESSOIRES / ACCESORIES	502
/ GUIDON // HANDLEBAR	121	/ EQUIPEMENTS VEHICULES / VEHICLES	
/ CÂBLE FREIN / BRAKE CABLE	132	EQUIPEMENTS	504
/ CÂBLE STARTER / STARTER CABLE	134	/ LUNETTES / GLASSES	520
/ CÂBLE EMBRAYAGE / CLUTCH CABLE	140	/ TOP CASES / TOP CASES	523
/ LEVIER-POIGNEE / LEVER-HANDLE	154		
/ CÂBLE GAZ / GAZ CABLE	156	ÉLECTRICITÉ	539
/ REVÊTEMENT / GRIP	185	/ BATTERIES / BATTERIES	540
/ RÉTROVISEUR / WING MIRROR	194	/ BOUGIES / SPARK PLUGS	652
/ BÉQUILLE / STAND	200	/ ANTIPARASITES / SPARK PLUG CAPS	776
/ PÉDALE / PEDAL	202		
/ FOURCHE / FORK	206	FILTRATION	805
/ JOINT SPI / FORK OIL SEAL			
• MOTO / MOTORCYCLE	207	FREINAGE	861
• MAXI SCOOTER / MAXI SCOOTER	243	/ DISQUES DE FREIN / BRAKE DISKS	862
• OFF-ROAD / OFF ROAD	252	/ PLAQUETTES DE FREIN - MÂCHOIRES	
• MOTO ANCIENNE / OLD MOTOORCYCLE	286	DE FREIN / BRAKE PADS - BRAKE SHOE	874
/ SUPPORT / MOUNT	295		
/ CARROSSERIE / BODY KIT	296	TRANSMISSION	1171
/ ECLAIRAGE / LIGHTING	302	/ COURROIE / BELT	1172
		/ KIT CHAINE / CHAIN KIT	1201
		INDEX ALPHABÉTIQUE FRANÇAIS	1210
		INDEX ALPHABÉTIQUE ANGLAIS	1212
		CONDITIONS GÉNÉRALES DE VENTE	1214

MOTEUR

CYCLE

PNEUMATIQUE

ATELIER

ACCESSOIRES

ÉLECTRICITÉ

FILTRATION

FREINAGE

TRANSMISSION











/ ALLUMAGE / IGNITION	11
/ CARBURATION / CARBURATION	27
/ CULASSE / CYLINDER HEAD	34
/ CYLINDRE / CYLINDER	36
/ JOINT / GASKET	38
/ ÉCHAPPEMENT / EXHAUST	40
/ EMBIELLAGE / CRANKSHAFT	76
/ EMBRAYAGE / CLUTCH	77
/ ENGRENAGE / GEAR	79
/ REFROIDISSEMENT / COOLING	80
/ VARIATEUR / VARIATION	84





/ RÉGULATEUR DE TENSION MAXI SCOOTER

Désignation	Réf.	
REGULATEUR DE TENSION MAXI SCOOTER TEKNIX ADAPT. 125 HONDA SHI 2005->2012	490625	
REGULATEUR DE TENSION MAXI SCOOTER TEKNIX ADAPT. 125 KYMCO AGILITY 08->09	490624	
REGULATEUR DE TENSION MAXI SCOOTER TEKNIX ADAPT. 125 MAJESTY/SKYLINER 1998->2000/MADISON	490623	
REGULATEUR DE TENSION MAXI SCOOTER TEKNIX ADAPT. 125 MAJESTY/SKYLINER/ELYSEO	480414	
REGULATEUR DE TENSION MAXI SCOOTER TEKNIX ADAPT. 125 NMAX 2015-2020 /300 XMAX 2017-2020 OEM: 4B4-HI960-01 - 2GS-HI960-01	518015	
REGULATEUR DE TENSION MAXI SCOOTER ADAPT. 125 PIAGGIO/PEUGEOT TOUS MODELES <i>Régulateur de tension type origine adaptable sur les scooters MP3 125 de 2008 à 2010, MP3 250 de 2006 à 2009, MP3 400 de 2007 à 2011, Beverly 250 de 2006 à 2009, Beverly 400 de 2006 à 2010, Beverly 500 de 2005 à 2012, Carnaby 250, Vespa GTS de 2005 à 2009, Xevo 250 wde 2007 à 2011, X7 250 de 2008 et plus, X8 250 de 2005 à 2008, Xevo 400 de 2007 à 2011, X8 400 de 2006 à 2008 et X9 500 Evolution.</i>	484661	
REGULATEUR DE TENSION MAXI SCOOTER TEKNIX ADAPT. 125 SCOOTER CHINOIS/GY6	501112	
REGULATEUR DE TENSION MAXI SCOOTER TEKNIX ADAPT. 125 SYM/KYMCO/HONDA/PIAGGIO/MALAGUTI	484657	
REGULATEUR DE TENSION MAXI SCOOTER TEKNIX ADAPT. 125 XMAX 12->13/CYGNUS/FLAME 04->YZF	490628	











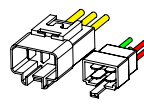

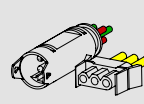

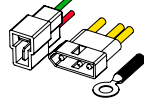

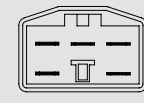

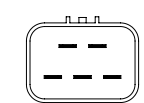
/ RÉGULATEUR DE TENSION MAXI SCOOTER

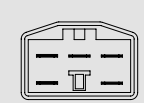
Désignation	Réf.		
REGULATEUR DE TENSION MAXI SCOOTER TEKNIX ADAPT. 125 XMAX 2010->/PEUGEOT 125/YZF	484660		
REGULATEUR DE TENSION MAXI SCOOTER TEKNIX ADAPT. 125 XMAX/SKYCRUISER ->2010	484659		
REGULATEUR DE TENSION MAXI SCOOTER TEKNIX ADAPT. 125 YAMAHA CYGNUS 2004->/ MBK FLAME 2004->	503819		
REGULATEUR DE TENSION MAXI SCOOTER TEKNIX ADAPT. 125/400 SUZUKI BURGMAN 07->10	490626		
REGULATEUR DE TENSION MAXI SCOOTER TEKNIX ADAPT. 125/500 KYMCO DOWNTOWN 09->10/ X-CITING 31600-KED9-900, 31600-KED9-E10, 31600-LDG7-900 KYMCO Xciting 250 2005-2014KYMCO Xciting 300 2005-2014KYMCO Xciting 500 2005-2014KYMCO DOWNTOWN 125 2009-2011KYMCO DOWNTOWN 200 2011-2014KYMCO DOWNTOWN 300 2009-2014KYMCO People 125 2011-2012KYMCO People 200 2012-2014KYMCO People 250 2007-2008KYMCO People 300 2008-2014KYMCO Quannon150 2010-2014KYMCO DINK 200 EU3i 2006-2007	490627		
REGULATEUR DE TENSION MAXI SCOOTER TEKNIX ADAPT. 250 HONDA SH/PANTHEON/ FORZA/PIAGGIO X9	484658		
REGULATEUR DE TENSION MAXI SCOOTER TEKNIX ADAPT. 250 YAMAHA XMAX/ SKYCRUISER 2007->2009	503820		
REGULATEUR DE TENSION MAXI SCOOTER TEKNIX ADAPT. 300 HONDA SH 2011->	503811		
REGULATEUR DE TENSION MAXI SCOOTER TEKNIX ADAPT. 300 KAWASAKI J 2014->	503812		

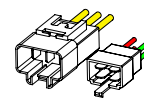
/ RÉGULATEUR DE TENSION MAXI SCOOTER

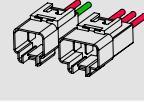
Désignation	Réf.	
REGULATEUR DE TENSION MAXI SCOOTER TEKNIX ADAPT. 300 PIAGGIO MP3/VESPA GTS/ ATLANTIC (5 FIL	503813	
REGULATEUR DE TENSION MAXI SCOOTER TEKNIX ADAPT. 50/125 VESPA PK/PX (3 PLOTS-1616395)	503821	
REGULATEUR DE TENSION MAXI SCOOTER TEKNIX ADAPT. 500 YAMAHA TMAX 2008-2011	488118	
REGULATEUR DE TENSION MAXI SCOOTER TEKNIX ADAPT. 500/530 YAMAHA TMAX	500355	
REGULATEUR DE TENSION SCOOTER TEKNIX ADAPT. KISBEE/VIVACITY 3/TWEET/ SYMPHONY/FIDDLE 2 4T OEM PEUGEOT : 775847	490408	
REGULATEUR DE TENSION SCOOTER/MAXI SCOOTER TEKNIX ADAPT. SYM SYMPHONY/ FIDDLE III - OEM: 31600-M92-000-XS	524429	
REGULATEUR DE TENSION SCOOTER/MAXI SCOOTER TEKNIX ADAPT. 50/125 VESPA PK/ PX (230824)	485692	
REGULATEUR DE TENSION SCOOTER/MAXI SCOOTER TEKNIX ADAPT. CHINOIS/ GY6/139QMB/152QMI 4 TEMPS <i>Adaptable sur tous les scooters chinois (ayant des stators 6 ou 8 pôles). Il peut arriver que le connecteur plastique soit différent, mais il suffit dans ce cas, de récupérer l'ancien, et de brancher les fils du nouveau régulateur. Respecter toujours la couleur des fils. Si il y a un fil rose, celui-ci devra se mettre sur le fil blanc.</i>	503826	
REGULATEUR DE TENSION MAXI SCOOTER ADAPT. 250/400/500 PEUGEOT/APRILIA/ PIAGGIO	485693	
REGULATEUR DE TENSION SCOOTER/MOTO TEKNIX ADAPT. ZIP/LIBERTY/FLY/VESPA 4T/ DERBI SENDA 18-> 5 FichesRéférence OEM : 639751/641788/02602800/969825	482114	

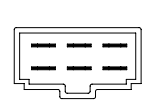

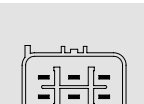







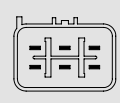

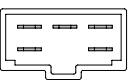

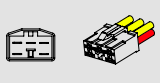

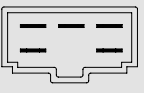

/ RÉGULATEUR DE TENSION MOTO

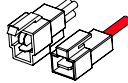
Désignation	Réf.		
<p>REGULATEUR DE TENSION MOTO ADAPT. APRILIA</p> <p>Aprilia RSV4 1000 Factory 2011-2017Aprilia RSV4 R 1000 2011-2015Aprilia RSV4 RF 1000 2015-2017 Aprilia RSV4 1000 APRC Factory ABS 2013-2014Aprilia RSV4 1000 APRC R ABS 2013-2014Aprilia RSV4 1000 Racing Factory L.E 2015-2016Aprilia RSV4 1000RR 2015-2017Aprilia RSV 1000 Tuono V4 APRC ABS 2014Aprilia RSV 1000 Tuono V4 STD/APRC 2011Aprilia RSV 1100 Tuono V4 Factory 2015-2017Aprilia RSV 1100 Tuono V4 RR 2015-2017Aprilia Tuono V4 1000 2012-2015</p>	517708		
<p>REGULATEUR DE TENSION MOTO ADAPT. BMW</p> <p>BMW F650CS 2000-2011BMW F650GS Dakar 2000-2010BMW F650GS Dakar/M 2003- 2012BMW F650GS Twin 2009-2015BMW F650GS(K72) 2006-2012BMW F650GS (R13) 1999- 2014BMW F700GS (K70) 2006-2016BMW F800ST 2005-2013BMW F800GS 2005-2016</p>	517716		
<p>REGULATEUR DE TENSION MOTO ADAPT. BMW</p> <p>BMW F650 1997-2001BMW F650GS 1999-2011BMW F650ST 1997-1998BMW F650CS 2002- 2011BMW G650X 2007-2011BMW F800S 2007-2011BMW F800ST 2007-2011BMW F650GS Dakar 2000-2008BMW F650GS 2000-2011</p>	517717		
<p>REGULATEUR DE TENSION MOTO ADAPT. HONDA</p> <p>HondaCB-1 (CB400FM) (NC27)CB250CB400CB400F (NC31)CB400SF (NC39) CB500CB600CBR1100XX BLACKBIRD CARBURATOR MODEL (1996-1999) CBR250CBR400CBR400RR (NC23)CBR400RR (NC29)CBR500CBR600 F, F2, F3CBR600 FN, FR, FR2 (PC25)CBR600 PC31CBR600F (PC25)</p>	517709		
<p>REGULATEUR DE TENSION MOTO ADAPT. HONDA</p> <p>Honda TRX350 FE FM TE TM 2000-2003Honda TRX400 FW 1995-2003Honda TRX450ES 1999-2001Honda TRX450R 2004-2005Honda TRX450S 1998-2001Honda VT750C SHADOW AERO 2004-2009Honda VT750C2 SHADOW SPIRIT 2007-2009Honda VT750 C2F SHADOW SPIRIT 2007-2009Honda VT750CA SHADOW AERO 2004-2009</p>	517710		
<p>REGULATEUR DE TENSION MOTO ADAPT. HONDA</p> <p>Honda CB-1Honda CB-1 (CB400F)Honda CB250 Hornet 250Honda CB250 Two Fifty 1991-2008Honda CB250 Two Fifty 1991-2008Honda CB400 SFHonda CB400 SFHonda CB400 VTECHonda CB400VTECHonda CB500Honda CB500Honda CB600 Hornet600 1998-2006Honda CB600 2004-2006Honda CBR1100XX 1998-2000Honda CBR250 MC17 MC19 MC22Honda CBR250 MC17 MC19MC22Honda CBR400 NC23 NC29Honda CBR400 NC23 NC29Honda CBR600 F2 F3 1991-1999Honda CBR600 F2 F3 1991-1999</p>	517711		
<p>REGULATEUR DE TENSION MOTO ADAPT. HONDA</p> <p>Honda CBR600 F4i 2001-2007Honda CBR600RR F5 2003-2006 (PC37)Honda CB900 (CB919)2002-2007Honda CBR900 CBR954 CBR929 2001-2003Honda CBR1100XX 2001-2004</p>	517712		
<p>REGULATEUR DE TENSION MOTO ADAPT. HONDA</p> <p>HONDA CBR1000RR 04-07 CB1300 05-08 CBR600RR 07-12Honda CBF1000, CBR600F4i, CBR1100;HONDA VTX1300 2010/CBR600 RR CBF1000 NT700 VTX1300</p>	517713		
<p>REGULATEUR DE TENSION MOTO ADAPT. KAWASAKI</p> <p>Kawasaki ZZR600 ZX600D 1990-1992Kawasaki ZXR400 H1/H2 1989-1990 Kawasaki ZZR600 D 90-93Kawasaki KLF300 Bayou 86-98Kawasaki GPZ600 R 85-89Kawasaki ZL600 Eliminator 1996-1997Kawasaki VN750 88-06Kawasaki GPX600 R 88-96Kawasaki ZZR600 E 93-03Kawasaki VN1500 1987-1999Kawasaki ZR750 Zephyr 91-93</p>	517696		
<p>REGULATEUR DE TENSION MOTO ADAPT. KAWASAKI</p> <p>Kawasaki ER650 ER-6N 2009Kawasaki EX650R Ninja 650R 2006-2009Kawasaki KAF 620E Mule 3010 4x4 93-2008Kawasaki KAF 620F Mule 3020 1993-2002Kawasaki KAF 620G Mule 3000 2001-2008Kawasaki KAF 650J Mule 3010 4x4 2005-2008Kawasaki KLE650 Versys 2008-2009Kawasaki KRF750 TERYX 4X4 2008</p>	517700		

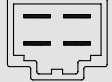
/ RÉGULATEUR DE TENSION MOTO

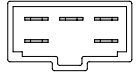
Désignation	Réf.		
<p>REGULATEUR DE TENSION MOTO ADAPT. KAWASAKI Kawasaki NINJA ZX-10R ZX1000 2008-2014Kawasaki NINJA ZX-6R 2009-2014</p>	517705		
<p>REGULATEUR DE TENSION MOTO ADAPT. KAWASAKI Kawasaki ZX636 Ninja ZX-6R 2013-2017 Kawasaki ZX636 Ninja ZX-6R ABS 30th Anniversary Edition 2015 Kawasaki ZX636 Ninja ZX-6R ABS 2013-2017 Kawasaki ZX636 Ninja ZX-6R ABS KRT Edition 2016-2017</p>	517706		
<p>REGULATEUR DE TENSION MOTO ADAPT. KAWASAKI/YAMAHA Kawasaki ZR750 ZEPHYR 750 1991-2006Kawasaki ZR550 (Zephyr) 1989-2003Yamaha XJ6 N 2011 Kawasaki ZZR400 1990-1999 1998 1997Yamaha YZR R6 600 Kawasaki Tengai 650 Yamaha YP400 Majesty400 05-12 Kawasaki KLE650 (VERSYS) 07-14 Kawasaki ER-4F ER-4N Ninja 400 11-12-1321066-1089 210661089</p>	517693		
<p>REGULATEUR DE TENSION MOTO ADAPT. KTM KTM Duke 125 2011 2016 90111034000KTM Duke 200 2012 2019 90111034000KTM Duke 250 2015 2016 90111034000KTM Duke 390 2013 2017 90111034000KTM RC 390 2014 2019 90511034000KTM RC 250 2015 2017 90511034000</p>	517714		
<p>REGULATEUR DE TENSION MOTO ADAPT. KTM KTM 990 Supermoto SM 2008-2011KTM Super Duke 990 2004-2015KTM Adventure 990 S LC8 2008KTM Adventure 990 LC8 2008-2010KTM Adventure 990 LC8 ABS 2008-2012KTM RC8 1190 R 2009-2010KTM RC8 1190 2008-2012KTM Duke 690 2009-2014KTM Supermoto 690 R 2008</p>	517715		
<p>REGULATEUR DE TENSION MOTO ADAPT. SUZUKI Suzuki DR250 1990-1995Suzuki DR350 1990-1999Suzuki SV650 1999-2002Suzuki LS650 Savage 1986-2012</p>	517718		
<p>REGULATEUR DE TENSION MOTO ADAPT. SUZUKI GSXR 600/750 2006-2013 GSXR 1000 2005-2013 GSX1300R Hayabusa 2008-2012 GSXR650F 2008-2012</p>	517719		
<p>REGULATEUR DE TENSION MOTO ADAPT. SUZUKI Suzuki GN125 1982-2001Suzuki AN125 5 wiresSuzuki AN150 5 wiresSuzuki GZ125 1998-2011Suzuki GZ250 1999-2011</p>	517720		
<p>REGULATEUR DE TENSION MOTO ADAPT. SUZUKI Suzuki GSXR600 1997-2005Suzuki GSXR750 1996-2005Suzuki GSXR1000 2001-2004Suzuki GSX1300R Hayabusa 1999-2007Suzuki VL1500 Intruder 1998-2004Suzuki LT-F500F Quadrunner 1998-1999</p>	517721		
<p>REGULATEUR DE TENSION MOTO ADAPT. SUZUKI Suzuki GSX650 GSX650 F 2008-2012Suzuki SV1000 2003-2007Suzuki SV650 2003-2012Suzuki GSXR600 2006-2011Suzuki GSXR750 2006-2011Suzuki GSXR1000 2005-2012Suzuki SFV650 2009-2011Suzuki GSF1250 2007-2010Suzuki DL650 (V-Strom) 2004-2012</p>	517722		
<p>REGULATEUR DE TENSION MOTO ADAPT. TRIUMPH TRIUMPH STREET TRIPLE 675 R675 2009-2011TRIUMPH STREET TRIPLE 675 2009-2010TRIUMPH STREET TRIPLE R 675 2010-2011TRIUMPH DAYTONA 955 T595 955i 1997-2006TRIUMPH DAYTONA 600 2004TRIUMPH DAYTONA 650 2005TRIUMPH TIGER 955 2001-2006</p>	517707		

/ RÉGULATEUR DE TENSION MOTO

Désignation	Réf.		
REGULATEUR DE TENSION MOTO ADAPT. YAMAHA YamahaYZF R6 2006-2012XVS650 V-Star Custom 2000XVS650 V-Star Classic 1998-2000XVS1100 V-Star Custom 2000-2009XVS1100 V-Star 1999-2002XVS 250 Dragstar 2000-2004XVS 125 Dragstar 2000-2004WR250R 2008-2013VP300 2003-2004	517694		
REGULATEUR DE TENSION MOTO ADAPT. YAMAHA Yamaha Majesty 250 - 2000Yamaha XJ 600 Diversion/N 1996 -Yamaha SRX 250 1986 - 1987Yamaha YP 250 Majesty 4UC/SG04 1996 - 2002Yamaha XP 500 T-Max SJ01 01 - 04Yamaha SZR 660 4SU 1996 - 2000Yamaha XTZ 660 Tenere 3YF/4MD 1994 - 2000Yamaha XVS 650 Dragstar 1997 - 1998Yamaha XJ 600 S/N Diversion 1992 - 2003Yamaha FZR 600 R 1995 - 1999	517695		
REGULATEUR DE TENSION MOTO ADAPT. YAMAHA Yamaha BT1100 2002-2006Yamaha FZ6 FZ6N FZ6S 2004-2009Yamaha FZ6 FZ6N FZ6S 2004-2009Yamaha FZ6R 2009-2013Yamaha FZR600 1994-1995Yamaha FZR600 1994-1995Yamaha GRIZZLY 600 YFM600 1999-2001Yamaha GRIZZLY 660 YFM660 2002-2008	517697		
REGULATEUR DE TENSION MOTO ADAPT. YAMAHA Yamaha YFM Grizzly 550 OEM?ID7-81960-00Yamaha YZF R1 1000 2002-2012 FZ1 06--10Ski Doo Tundra 600 OEM?515177325Polaris Ranger 500 OEM?4012941Honda TRX FE/FGA/FM/FPA/TM 500 OEM?31600-HPO-A0IKawasaki KVF Brute Force 750 OEM?21066-0022	517698		
REGULATEUR DE TENSION MOTO ADAPT. YAMAHA Yamaha V-STAR XVS400 DS400 1996-2008 , Yamaha YZF R6 1997-2002 Yamaha YZF R1 1999-2001, Yamaha YZF600 1996-2005, Yamaha XP500 T-MAX500 2001-2006 Yamaha TDM850 4TX TDM 850 1996-2001, Yamaha FZ6 FZ6N FZ6S 2004-2009 Yamaha YZF R6 2003-2005 03 04 05	517699		
REGULATEUR DE TENSION MOTO ADAPT. YAMAHA Yamaha XV535 XV 535 VIRAGO 1987-1990Yamaha XV535 XV 535 VIRAGO 1993-1996Yamaha XV700 XV 700 VIRAGO 1986-1987Yamaha XV750 XV 750 VIRAGO 1988-1996Yamaha XV1100 XV 1100 VIRAGO 1984- 3DM-81960-00	517701		
REGULATEUR DE TENSION MOTO ADAPT. YAMAHA Yamaha XT225 1991-2004Yamaha XT250 2005-2007Yamaha TW200 2000-2002Yamaha TW225 2002-2007Yamaha TW125 1999-2004Yamaha XT600 1994-2002Yamaha TTR250 1993-2002Yamaha FZR400 1990-1994Yamaha XJ400 1992-1993Yamaha XJ600 1992-1996	517702		
REGULATEUR DE TENSION MOTO ADAPT. YAMAHA Yamaha XJ600 1997-2003Yamaha XJR400 1993-2007Yamaha Majesty250 YP250 1995-2001	517703		
REGULATEUR DE TENSION MOTO ADAPT. YAMAHA Yamaha XV250 Virago 1989Yamaha XT600 1986-1993Yamaha FZR500 1989-1993Yamaha FZR600 1989-1993Yamaha FZR250 1987-1994Yamaha FZX250	517704		
REGULATEUR DE TENSION MOTO/MAXISCOOTER ADAPT. BMW BMW C Sport 650 de 2015 a 2017 12317718422BMW C Sport 600 de 2011 a 2015 12317718422BMW C GT 650 de 2011 a 2017 12317718422BMW HP4 1000 de 2012 a 2015 12317718422BMW R R 1200 de 2014 a 2017 12318523367BMW R GS Adventure 1200 de 2013 a 2017 12318523367BMW R RT 1200 de 2013 a 2017 12318523367BMW R GS 1200 de 2012 a 2017 12318523367	517723		



508555



485686



490619



515130



490617



515131



490618



168386

/ BOBINE HAUTE TENSION EXTÉRIEURE

Désignation	YAMAHA	TEKNIX
BOBINE H.T. MAXI SCOOTER EXTERIEURE OEM YAMAHA 500 TMAX 2004-> (4B5823200000)	508555	
BOBINE H.T. MAXI SCOOTER EXTERIEURE TEKNIX ADAPT. 125 HONDA SHI/PANTHEON/SWING		485686
BOBINE H.T. MAXI SCOOTER EXTERIEURE TEKNIX ADAPT. 125 KYMCO DOWNTOWN/PEOPLE /50 APRILIA SR		490619
BOBINE H.T. MAXI SCOOTER EXTERIEURE TEKNIX ADAPT. 125 PIAGGIO FLY /LIBERTY/VESPA LX/YOURBA		515130
BOBINE H.T. MAXI SCOOTER EXTERIEURE TEKNIX ADAPT. 125/250/300/500 PIAGGIO/PEUGEOT/GILERA		490617
BOBINE H.T. MAXI SCOOTER EXTERIEURE TEKNIX ADAPT. 500 MP3/X10/GILERA FUOCO/800 GP/SRV		515131
BOBINE H.T. SCOOTER/MAXI SCOOTER EXTERIEURE TEKNIX ADAPT. 125 SYM HD/EVO 50 TWEET 4 TEMPS		490618
BOBINE H.T. SCOOTER EXTERIEURE TEKNIX ADAPT. TOUS PEUGEOT X9/X8 125/VES		168386



490622



490620



490621



479194



485684



488117

/ BLOC CDI

Désignation	TEKNIX	TOP PERFORMANCES
BLOC CDI MAXI SCOOTER TEKNIX ADAPT. 125 KYMCO GRAND DINK 2001->2006/DINK ->2000 -AC	490622	
BLOC CDI MAXI SCOOTER TEKNIX ADAPT. 125 KYMCO AGILITY R16 2008->/SUPER 8 2008->	490620	
BLOC CDI MAXI SCOOTER TEKNIX ADAPT. 125 KYMCO DINK/GRAND DINK/SUPER DINK 2006->	490621	
BLOC CDI MAXI SCOOTER TEKNIX ADAPT. 125 SCOOTER CHINOIS 4T (152QM1)	479194	
BLOC CDI MAXI SCOOTER TEKNIX ADAPT. SYM JOYRIDE/FIDDLE II/SYMPHONY/TWEET/FIGHT3 4T ->2018	485684	
BLOC CDI MAXI SCOOTER TOP PERF ADAPT. 125/200 VESPA PX/ET3/PK/P200E		488117



/ BOBINE CDI HAUTE TENSION

Désignation	Réf.
BOBINE/CDI H.T. SCOOTER/MAXI SCOOTER TEKNIX ADAPT. 50/125 VESPA PX	485685





1910



512089



491478



506912



520463



506901



169000

/ FIL DE BOUGIE

Désignation	SELECTION CGN MOTORISE	MALOSSI
FIL BOUGIE D5 NOIR (5M)	1910	
FIL BOUGIE D5 ROUGE (5M)	512089	
FIL BOUGIE D5 TRANSPARENT (5M)	491478	
FIL BOUGIE D6 NOIR (5M)	506912	
FIL BOUGIE D7 MALOSSI ROUGE (0.50M) + ANTIPARASITE 5KOHMS		520463
FIL BOUGIE D7 NOIR (0.50M) + ANTIPARASITE	506901	
FIL BOUGIE D7 NOIR (5M)	169000	



513557



513555



513556

/ BOITIER ELECTRONIQUE

Désignation	Réf.
BOITIER ELECTRONIQUE MAXI SCOOTER MALOSSI EMULATEUR DE SONDE LAMBDA ADAPT. 125 XMAX	513557
BOITIER ELECTRONIQUE MAXI SCOOTER MALOSSI EMULATEUR DE SONDE LAMBDA ADAPT. 400 METROPOLIS	513555
BOITIER ELECTRONIQUE MAXI SCOOTER MALOSSI EMULATEUR DE SONDE LAMBDA ADAPT. 530 TMAX 2012->	513556



/ BOITIER TCF

Désignation	Réf.
BOITIER TCF POLINI ADAPT. YAMAHA TMAX 530/560 2017-> PERMET D'EVITER LES COUPURES CONTACTS ANTIPATINAGE LORS D'UN MONTAGE DE VARIATEUR	511077



510486



489500



488126



488127

/ COURONNE/PIGNON LANCEUR DEMARREUR MAXI SCOOTER

Désignation	MB/ YAMAHA	TEKNIX	TOP PERF TYPE ORIGINE
125 XMAX/SKYCRUISER 5YPE55240000	510486		
ADAPT. 125 BURGMAN 02-11		489500	
ADAPT. 125 XMAX/SKYCRUISER/EVOLIS			488126
ADAPT. 500/530 TMAX			488127



/ ROUE-LIBRE DÉMARREUR



489499 489502 489503 489501

Désignation	Réf.
ROUE LIBRE DEMARREUR MAXI SCOOTER TEKNIX ADAPT. 125 YAMAHA XMAX/MBK SKYCRUISER 06->11	489499
ROUE LIBRE DEMARREUR MAXI SCOOTER TEKNIX ADAPT. 125/150 HONDA SH	489502
ROUE LIBRE DEMARREUR MAXI SCOOTER TEKNIX ADAPT. 125/150 SUZUKI BURGMAN 02->11	489503
ROUE LIBRE DEMARREUR MAXI SCOOTER TEKNIX ADAPT. 125/180 YAMAHA MAJESTY/MBK SKYLINER 03->09	489501



/ DEMARREUR MAXI SCOOTER

Désignation	SELECTION CGN MOTORISE	TEKNIX	TOP PERFORMANCES
ADAPT. 100 BOOSTER/BWS/NITRO/AEROX/OVETTO/NEOS	520558		
ADAPT. 125 PIAGGIO MP3/VESPA S/LX 4TEMPS 3V IE	520561		
ADAPT. PIAGGIO 100 ZIP/LIBERTY/180 RUNNER	520557		
ADAPT.100 SYM MIO/125 FIDDLE 2 ->2013/125 JET 4 ->2013	520562		
ADAPT. 125 DINK AM/PEOPLE/HEROISM/FIDDLE II/ORBIT/SYMPLY		485711	
ADAPT. 125 DINK/GRAND DINK ->07		485712	
ADAPT. 125 HONDA SH/DYLAN/PANTHEON/PS (31200KGF901/902)		490641	
ADAPT. 125 KYMCO AGILITY R12/16/DINK/GRAN DINK/SYM FIDDLE 08		490642	
ADAPT. 125 KYMCO GRAND DINK/DINK 01->13 (0012751-00128219)		490643	
ADAPT. 125 MAJESTY/CYGNUS/SKYLINER (TYPE ORIGINE)		482830	
ADAPT. 125 PIAGGIO X7/X8/X9/X EVOL/FLY/LIBERTY (4 TEMPS)		482831	
ADAPT. 125 SCOOT CHINOIS/ GY6		466794	
ADAPT. 125 SYM GTS/JOYRIDE/JOYMAX		485713	
ADAPT. 125 XMAX/SKYCRUISER/EVOLIS/XCITY/CITYLINER (TYPE ORI		488104	
ADAPT. 125/150/200 VESPA PX		498897	
ADAPT. 125/150/200/400 SUZUKI BURGMAN UH 2000->		491459	
ADAPT. 125/250/300 VESPA GTS/BEVERLY/250 X7/X8/X9		498895	
ADAPT. 250 SKYLINER/300 KILIBRE/250/400 XMAX		498896	
ADAPT. 250/400 XMAX/XCITY/VERSITY/EVOLIS		502369	
ADAPT. 400/500 FUOCO/MP3/SATELIS/SCARABEO		490629	
ADAPT. 500 YAMAHA TMAX->2007		497621	
ADAPT. 500/530 YAMAHA TMAX 2008-> (4B5818900000)		495697	
ADAPT. 125 SYM 4T (TYPE ORIGINE)			482832



498894

502371

520554

520555

520556

520559

520560

Selection
CGN

/ DEMARREUR MOTO

Désignation	Réf.
ADAPT. 125 /YAMAHA YBR/XTR DERBI SENDA SM/R	498894
ADAPT. 125 HONDA CBR 2004-2010	502371
ADAPT. 125 HONDA CBR 2011-2018 (31200-KPP-T01) 9 DENTS	520554
ADAPT. 125 SUZUKI GN/DR/CG /MASH/BULLIT	520555
ADAPT. 125/150 HONDA CBF / ARCHIVE/AM60/AM64	520556
ADAPT. 125/250 HONDA CM/REBEL	520559
ADAPT. 125/250 YAMAHA XV/VIRAGO/DRAGSTAR	520560

mash



/ RELAIS DEMARREUR

Désignation	Réf.
MECABOITE/MOTO ADAPT. MASH 50 FIFTY/DIRT TRACK/125 CAFE RACER/SCRAMBLER	511002

TUN'R



/ LIMITEUR REGIME MOTEUR

Désignation	Réf.
LIMITEUR REGIME MOTEUR TUN'R UNIVERSEL SCOOTER/MECABOITE	481855

TEKNIX



/ PIGNON LANCEUR DÉMARREUR

Désignation	Réf.
ADAPT. PIAGGIO/VESPA 125 4 TEMPS 00-> (14/40)	489498



503814

503815

503817

491742



503816



520032



207752



484655

TEKNIX

/ RELAIS DEMARREUR

Désignation	Réf.
ADAPT. 125 HONDA SH/PANTHEON/DYLAN (4 CONNECTEURS)	503814
ADAPT. 125 MAJESTY/CYGNUS/SKYLINER/FLAME	503815
ADAPT. 250 MAJESTY/SKYLINER	503817
ADAPT. 4 TEMPS GILERA/PIAGGIO/YAMAHA	491742
ADAPT. 500 TMAX 2001->2010 (4 CONNECTEURS)	503816
ADAPT. YAMAHA 2011-> (4 CONNECTEURS)	520032
ADAPT. 4 TEMPS 12V 100 AH	484655
ADAPT. BOOSTER ->03/TMAX500->04/F12/MAJESTY/DT 125->00/YBR	207752

/ PIGNON LANCEUR DÉMARREUR



510609

510811

Désignation	GRUPE PIAGGIO	SYM
OEM PIAGGIO/VESPA 2 ET 4 TEMPS (14/63) - 82958R/286174	510609	
OEM SYM ORBIT/ORBIT II/FIDDLE II/JET 4/ SYMPLY - 2 TEMPS		510811

TEKNIX



/ PORTE FUSIBLE

Désignation	Réf.
PORTE FUSIBLE (POUR FUSIBLE PLAT ENFICHABLE) LIVRE AVEC FUSIBLE 7A	478328



/ RUPTEUR

Désignation	Réf.
RUPTEUR SCOOTER/MAXI SCOOTER ADAPT. 50/125 VESPA (REF ORIGINE 101761)	485691



/ CAPTEUR ALLUMAGE/CDI MAXI SCOOTER

Désignation	Réf.
ADAPT. 125 MAJESTY/SKYLINER/XCITY	493068
ADAPT. 500 YAMAHA TMAX	493069
ADAPT. 530 YAMAHA TMAX	493070



493068



493069



493070



/ CONDENSATEUR SCOOTER/MAXI SCOOTER

Désignation	Réf.
ADAPT. 50/125 VESPA (REF ORIGINE 078937)	485689
ADAPT. 50/125 VESPA (REF ORIGINE 079697)	485690



485689



485690



/ STATOR MAXI SCOOTER/MOTO

Désignation	Réf.
STATOR MAXI SCOOTER TOP PERF ADAPT. 125 SYM JOYMAX/JOYRIDE/HD/EVO	490406



/ STATOR MAXI SCOOTER

Désignation	Réf.
STATOR MAXI SCOOTER ADAPT. 125 KYMCO AGILITY R12 4 TEMPS 06->09 (00128172)	490609
STATOR MAXI SCOOTER ADAPT. 125 KYMCO DINK/GRAND DINK (00128947) COMPATIBLE :Beta EIKON 125-150Kymco : B&W 125-150B&W 125-150 E2Dink 125-150 97/98Dink E3 125-150 06/07Dink Classic E2 125-150Dink LX 125-150Grand Dink E2 125-150 (ref origine 00128947)	490606
STATOR MAXI SCOOTER ADAPT. 125 PIAGGIO MOTEUR LEADER 12 POLES(828135/584690/833697)	485709
STATOR SCOOTER/MAXI SCOOTER ADAPT. 50/125 VESPA PK/LX 3 POLES (OEM 199495)	490615





/ STATOR MAXI SCOOTER

Désignation	Réf.		
STATOR MAXI SCOOTER TEKNIX ADAPT. 125 HONDA SHI 05->12 / 125 SH 01->04 (31120KTF640)	490614		
STATOR MAXI SCOOTER TEKNIX ADAPT. 125 KYMCO DINK 06->10 (CARBU)/GRAND DINK 08->09 (CARBU)	490607		
STATOR MAXI SCOOTER TEKNIX ADAPT. 125 KYMCO PEOPLE 05->10 (00128184)	490608		
STATOR MAXI SCOOTER TEKNIX ADAPT. 125 SKYLINER/MAJESTY/THUNDER/MAXSTER <i>16 Pôles</i>	480391		
STATOR MAXI SCOOTER TEKNIX ADAPT. 125 VESPA GTS/X10/MP3 YOURBAN (58202R/385224R)	490407		
STATOR MAXI SCOOTER TEKNIX ADAPT. 125 VESPA PX (217866) <i>5 Pôles</i>	485708		
STATOR MAXI SCOOTER TEKNIX ADAPT. 125 XMAX/SKYCRUISER 2006->/XCITY 2008-> (1B9H141000)	493135		
STATOR MAXI SCOOTER TEKNIX ADAPT. 125/150 LX - LXV - S E3 2009->2013	517169		
STATOR MAXI SCOOTER TEKNIX ADAPT. 125/150 VESPA ET4 1998->2005	517167		
STATOR MAXI SCOOTER TEKNIX ADAPT. 125/300 PIAGGIO VESPA GTS>10/MP3 IE/YURBAN ->10	490610		
STATOR MAXI SCOOTER TEKNIX ADAPT. 400/500 PIAGGIO MP3 (58108R)/GEOPOLIS/SATELIS 400(759735) <i>18 Pôles - 370W</i>	485710		

MOTEUR

CYCLE

PNEUMATIQUE

ATELIER

ACCESSOIRES

ÉLECTRICITÉ

FILTRATION

FREINAGE

TRANSMISSION

/ STATOR MAXI SCOOTER

Désignation	Réf.	
STATOR MAXI SCOOTER TEKNIX ADAPT. 500 YAMAHA TMAX 01->03 (5GJ814100100) 18 Pôles	490611	
STATOR MAXI SCOOTER TEKNIX ADAPT. 500 YAMAHA TMAX 04->07 (5VU814100200) 18 Pôles	490612	
STATOR MAXI SCOOTER TEKNIX ADAPT. 500 YAMAHA TMAX 08-> (4B5-81410-00-00) 18 Pôles	490613	
STATOR MAXI SCOOTER TEKNIX ADAPT. 530 YAMAHA TMAX 12->16 (59C01410000) 18 Pôles	493136	
STATOR SCOOTER/MAXI SCOOTER TEKNIX ADAPT. 50/125 VESPA APE/PK 5 POLES (OEM 199500)	490616	



/ STATOR MAXI SCOOTER/MOTO

Désignation	Réf.	
STATOR MOTO TEKNIX ADAPT. 125 APRILIA/FB MONDIAL/MALAGUTI/ORCAL <i>Stator d'allumage de type origine pour les motos 125cc 4T LC avec moteur Zongshen normes euro 3, 4 et 5 Aprilia - SX 125 - 2017 - 2020 Aprilia - RX 125 - 2017 - 2020 Aprilia - RS 125 - 2017 - 2020 Aprilia - RS4 125 - 2011 - 2016 Aprilia - Tuono New 125 - 2017 - 2020 Aprilia - RX 125 E5 - 2021 - 2022 Aprilia - SX 125 E5 - 2021 - 2022 Aprilia - RS 125 E5 - 2021 - 2022 Aprilia - Tuono 125 E5 - 2021 - 2022 FB Mondial - HPS 125 E5 - 2021 - 2022 FB Mondial - Flat Track FB Mondial 125 E5 - 2021 - 2022 FB Mondial - SMX FB Mondial 125 - 2019 - 2020 FB Mondial - Pagani 125 - 2019 - 2020 FB Mondial - Flat Track FB Mondial 125 - 2020 - 2020 FB Mondial - HPS 125 - 2017 - 2020 Malaguti - Drakon 125 E5 - 2021 - 2022 Malaguti - Monte 125 Pro - 2019 - 2021 Malaguti - XSM 125 - 2019 - 2021 Malaguti - XTM 125 - 2019 - 2021 Malaguti - Dune 125 - 2019 - 2021 Malaguti - Dune 125 E5 - 2021 - 2022 Malaguti - Dune X 125 E5 - 2021 - 2022 Malaguti - RST 125 - 2019 - 2021 Orcal - SK01 125 E5 - 2021 - 2022 Orcal - SK01 125 - 2019 - 2020 Valenti - RME 125 Z - 2021 - 2021 Valenti - SM 125 Z - 2021 - 2021 Valenti - RME 125 Z E5 - 2022 - 2022 Valenti - SM 125 Z E5 - 2022 - 2022</i>	520038	
STATOR MOTO TEKNIX ADAPT. 125 SUZUKI MARAUDER/VAN VAN	517163	
STATOR MOTO TEKNIX ADAPT. 125 YAMAHA XTR/XTX 2005->2007	517164	
STATOR MOTO TEKNIX ADAPT. 125 YAMAHA YBR 2005->2009 / XTX-R 2008->2010	517165	



/ CLAVETTE ALLUMAGE



/ CLAVETTE ALLUMAGE



Désignation	Réf.
DEMI LUNE (ASSORTIMENT DE 80 PCS)	504920

Désignation	Réf.
MAXI SCOOTER OEM 125 XMAX/MBK SKYCRUISER/MAJESTY (9028003X0000)	510385

/ BOISSEAU/MEMBRANE CARBURATEUR



501351



501352



487822



482824



501353

Désignation	SELECTION CGN MOTORISE	TEKNIX	TOP PERFORMANCES
MAXI SCOOTER ADAPT. 125 PIAGGIO POUR CARBU D.14MM (CM140302)	501351		
MAXI SCOOTER ADAPT. 125 PIAGGIO POUR CARBU D.16.8MM (CM140301)	501352		
MAXI SCOOTER TEKNIX ADAPT. 125 CHINOIS 4 TEMPS D.22MM		487822	
MAXI SCOOTER TOP PERF ADAPT. 125 MAJESTY/SKYLINER MINARELLI D.24MM			482824
SCOOTER ADAPT. PIAGGIO POUR CARBU KEIHIN CVK18 (CM146601)	501353		



510113



506508



506507



510421



468837



501185



490430



501184



502372



490431



482822



482823



499551



499550

/ PIPE D'ADMISSION MAXI SCOOTER

Désignation	SELECTION CGN MOTORISE	MB/ YAMAHA	TEKNIX	TOP PERFORMANCES
ADAPT. 125/180 YAMAHA/MBK 03->09 MAJESTY/SKYLINER	510113			
ADAPT. 530 TMAX 12-> - DROITE	506508			
ADAPT. 530 TMAX 12-> - GAUCHE	506507			
125 XMAX/MBK SKYCRUISER 1B9E35850000		510421		
ADAPT. 125 CHINOIS 4T/152QMI			468837	
ADAPT. 125 KYMCO DINK			501185	
ADAPT. 125 PIAGGIO 4 TEMPS (ORIGINE 874415/B016579)			490430	
ADAPT. 125 PIAGGIO/GILERA - 2 TEMPS			501184	
ADAPT. 125 YAMAHA/MBK/MINARELLI ->03			502372	
ADAPT. 125 KYMCO AGILITY 4 TEMPS R16				490431
ADAPT. 125 PIAGGIO/GILERA - 2 TEMPS				482822
ADAPT. 125 YAMAHA/MBK 03->09 MAJESTY/SKYLINE				482823
ADAPT. 500 TMAX 04->12 - DROITE (5VUI35960100)				499551
ADAPT. 500 TMAX 04->12 - GAUCHE (5VUI35860100)				499550

/ JOINT PIPE D'ADMISSION

Désignation	Réf.
TORIQUE MAXI SCOOTER OEM 125 XMAX/MBK SKYCRUISER 932103280700	510423

/ CALE ISOLANTE PIPE D'ADMISSION MAXI SCOOTER

Désignation	TEKNIX	MB/ YAMAHA
ADAPT. 125 CHINOIS 4T/152QMI/GY6	496101	
OEM 125 XMAX/MBK SKYCRUISER 1B9E35950000		510422

/ RECHAUFFEUR/RESISTANCE

Désignation	Réf.
PTC DE CARBU SCOOTER/MAXI SCOOTER ADAPT. PIAGGIO/GILERA/VESPA	510057

/ COMMANDE STARTER MANUEL

Désignation	Réf.
A CABLE MANUEL UNIVERSELLE	482746

/ STARTER

Désignation	Réf.
AUTOMATIQUE MAXI SCOOTER ADAPT. 125 PIAGGIO X7/X8/X9/GTS/XEVO SYM JOYRIDE	496924

/ CARBURATEUR CP

Désignation	Réf.
19 (DEPRESSION/GRAISSAGE) STARTER CABLE	483203
21 (DEPRESSION/GRAISSAGE) STARTER CABLE	483204

/ CARBURATEUR MAXI SCOOTER

Désignation	Réf.
ADAPT. CHINOIS 4T/152QMI (DIAMETRE 24)	468829

/ CARBURATEUR MKII TYPE PWK

Désignation	Réf.
34 POWER JET (BOISSEAU PLAT/STARTER TIRETTE/DEPRESSIO	500486

/ CARBURATEUR PHBH

Désignation	Réf.
28 BS MONTAGE SOUPLE STARTER MANUEL	477591
28 MONTAGE SOUPLE	478722





/ CARBURATEUR MOTO



/ CARBURATEUR PHBL



Désignation	Réf.
ADAPT. DAX/MONKEY/SKYTEAM (18MM)	505692

Désignation	Réf.
25 AM/SD MONTAGE SOUPLE STARTER MANUEL	450121
25 BT MONTAGE SOUPLE STARTER MANUEL	441293



460858



297686



499849



504740



450116



467791



517454



473460



467793



514073



499850



1233



477489



504741



491082



517453



467792



/ CARBURATEUR PHBG

Désignation	Réf.
19 AM MONTAGE SOUPLE (GRAISSAGE/DEPRESSION) STARTER CABLE NOIR	460858
19 BD MONTAGE SOUPLE STARTER CABLE - PRIX NET -	297686
19 BS MONTAGE SOUPLE STARTER TIRETTE	499849
19 DS MONTAGE SOUPLE (GRAISSAGE) STARTER CABLE	504740
19 DS MONTAGE SOUPLE (GRAISSAGE/DEPRESSION) STARTER CABLE	450116
19 BT MONTAGE SOUPLE STARTER CABLE	467791
19 DS MONTAGE SOUPLE (DEPRESSION/GRAISSAGE) STARTER TIRETTE	517454
19 MONTAGE SOUPLE (DEPRESSION/GRAISSAGE) STARTER CABLE NOIR	473460
19 MONTAGE SOUPLE STARTER CABLE	467793
21 BD MONTAGE SOUPLE STARTER A CABLE	514073
21 BS MONTAGE SOUPLE STARTER TIRETTE	499850
21 BT MONTAGE SOUPLE (DEPRESSION/GRAISSAGE) STARTER CABLE	1233
21 CS MONTAGE RIGIDE (GRAISSAGE) STARTER TIRETTE	477489
21 DS MONTAGE SOUPLE (GRAISSAGE) STARTER CABLE	504741
21 DS RACING MONTAGE SOUPLE (GRAISSAGE/DEPRESSION) STARTER CABLE	491082
21 BT MONTAGE SOUPLE (DEPRESSION/GRAISSAGE) STARTER TIRETTE	517453
21 BT MONTAGE SOUPLE STARTER CABLE	467792

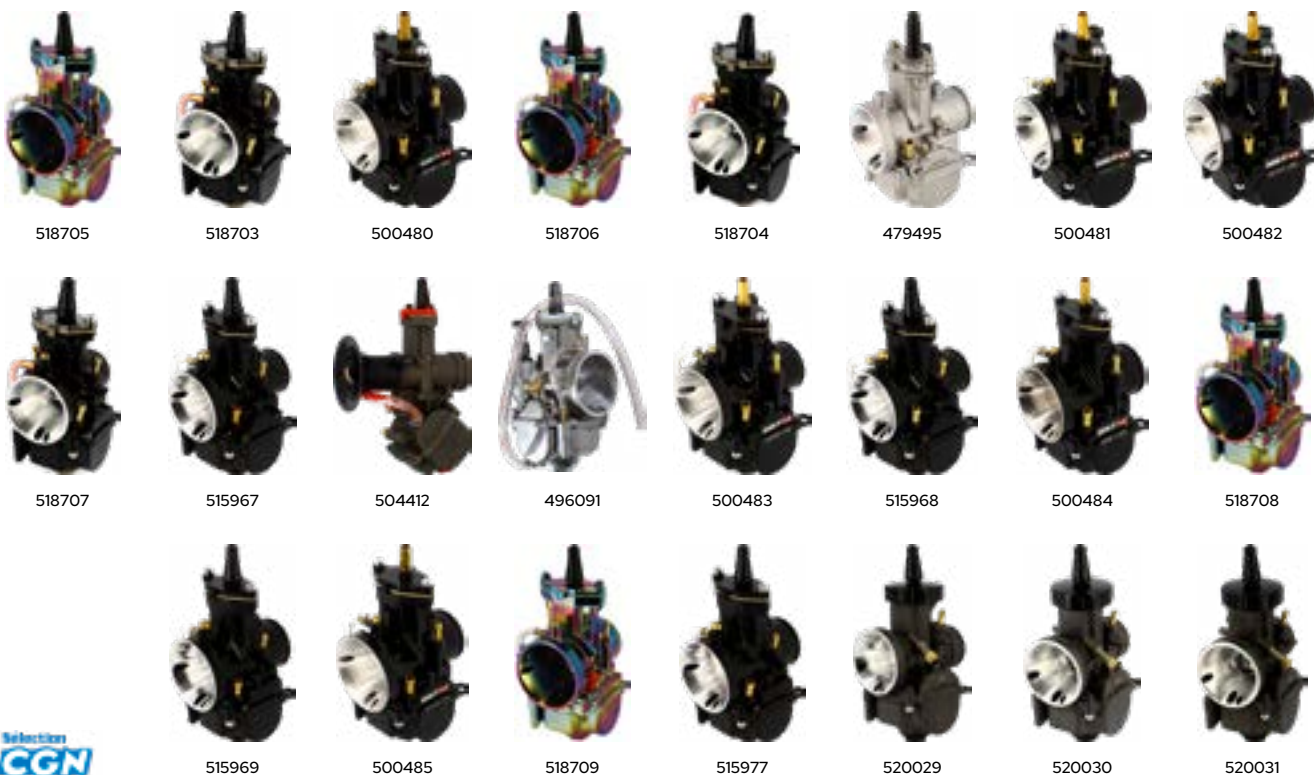

518705

518703

500480

518706

518704

479495

500481

500482

518707

515967

504412

496091

500483

515968

500484

518708

515969

500485

518709

515977

520029

520030

520031

/ CARBURATEUR PWK

Désignation	Réf.
21 AVEC POWER JET (BOISSEAU PLAT/STARTER TIRETTE) NEOCHROME	518705
21 AVEC POWER JET (BOISSEAU PLAT/STARTER TIRETTE) NOIR	518703
21 POWER JET (BOISSEAU PLAT/STARTER TIRETTE/DEPRESSION)	500480
24 AVEC POWER JET (BOISSEAU PLAT/STARTER TIRETTE) NEOCHROME	518706
24 AVEC POWER JET (BOISSEAU PLAT/STARTER TIRETTE) NOIR	518704
24 BOISSEAU PLAT (DEPRESSION) STARTER TIRETTE	479495
24 POWER JET (BOISSEAU PLAT/STARTER TIRETTE/DEPRESSION)	500481
26 POWER JET (BOISSEAU PLAT/STARTER TIRETTE/DEPRESSION)	500482
28 AVEC POWER JET (BOISSEAU PLAT/STARTER TIRETTE) NEOCHROME	518707
28 AVEC POWER JET (BOISSEAU PLAT/STARTER TIRETTE) NOIR	515967
28 CUVE INCLINEE 40° (BOISSEAU PLAT/STARTER TIRETTE) MANCHON 32/34	504412
28 POWER JET (BOISSEAU PLAT/STARTER TIRETTE)	496091
28 POWER JET (BOISSEAU PLAT/STARTER TIRETTE/DEPRESSION)	500483
30 AVEC POWER JET (BOISSEAU PLAT/STARTER TIRETTE) NOIR	515968
30 POWER JET (BOISSEAU PLAT/STARTER TIRETTE/DEPRESSION)	500484
32 AVEC POWER JET (BOISSEAU PLAT/STARTER TIRETTE) NEOCHROME	518708
32 AVEC POWER JET (BOISSEAU PLAT/STARTER TIRETTE) NOIR	515969
32 POWER JET (BOISSEAU PLAT/STARTER TIRETTE/DEPRESSION)	500485
34 AVEC POWER JET (BOISSEAU PLAT/STARTER TIRETTE) NEOCHROME	518709
34 AVEC POWER JET (BOISSEAU PLAT/STARTER TIRETTE) NOIR	515977
CORPS ROND 21 AVEC POWER JET (BOISSEAU PLAT/STARTER TIRETTE) GRIS	520029
CORPS ROND 24 AVEC POWER JET (BOISSEAU PLAT/STARTER TIRETTE) GRIS	520030
CORPS ROND 26 AVEC POWER JET (BOISSEAU PLAT/STARTER TIRETTE) GRIS	520031

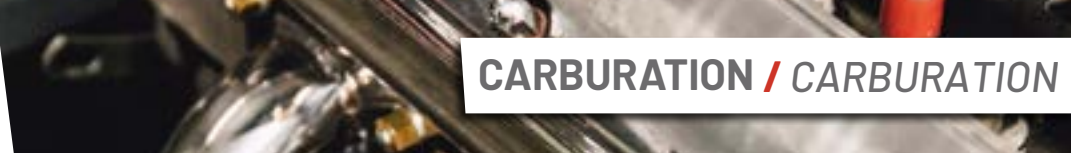

DELORTO

/ CARBURATEUR PHVB

Désignation	Réf.
19 DD MONTAGE SOUPLE (GRAISSAGE) STARTER MANUEL/AUTO	491087
22 CD MONTAGE SOUPLE (DEPRESSION/GRAISSAGE) STARTER AUTO	491085
22 CD MONTAGE SOUPLE (DEPRESSION/GRAISSAGE) STARTER CABLE	491086



491083

491084

DELORTO

/ CARBURATEUR VHST

Désignation	Réf.
26 BS MONTAGE SOUPLE BOISSEAU PLAT STARTER TIRETTE	491083
28 BS MONTAGE SOUPLE BOISSEAU PLAT STARTER TIRETTE	491084



/ COLLIER DURITE



Désignation	Réf.
COLLIER DURITE ESSENCE 3X6 (X1)	320765
COLLIER DURITE ESSENCE 4X7 (X1)	320770
COLLIER DURITE ESSENCE 5X8 (X1)	320784
COLLIER DURITE ESSENCE 6X9 (X1)	320799



/ DURITE ESSENCE NBR 5 M



Désignation	Réf.
NBR TEXTILE RENFORCE HAUTE QUALITE NOIR 4X10 mm	491334
NBR TEXTILE RENFORCE HAUTE QUALITE NOIR 4X9,5 mm	491333
NBR TEXTILE RENFORCE HAUTE QUALITE NOIR 5X10 mm	493307



506950

506948

506951

506952



/ DURITE ESSENCE NBR 5 M



/ DURITE ESSENCE 1M



Désignation	Réf.
DURITE ESSENCE 1M AVEC COLLIER 5X10	483417
DURITE ESSENCE 1M AVEC COLLIER 6X10	483418
DURITE ESSENCE 1M AVEC COLLIER 8X13	483419

Désignation	Réf.
NOIR + FILTRE ESSENCE CONIQUE PAPIER 5x8 mm	506950
NOIR + FILTRE ESSENCE CYLINDRIQUE 5x8 mm	506948
NOIR + FILTRE ESSENCE CONIQUE 6x9 mm	506951
NOIR + FILTRE ESSENCE PAPIER 6x9 mm	506952

/ DURITE ESSENCE 10 M

Désignation		Réf.
DOUBLE EPAISSEUR SPECIALE ESSENCE SANS PLOMB - VIOLETTE	4x7 mm	519184
DOUBLE EPAISSEUR SPECIALE ESSENCE SANS PLOMB - VIOLETTE	4,8X9	519187
DOUBLE EPAISSEUR SPECIALE ESSENCE SANS PLOMB - VIOLETTE	5,5x10	519186
DOUBLE EPAISSEUR SPECIALE ESSENCE SANS PLOMB - VIOLETTE	6X9 mm	519185

/ DURITE ESSENCE 10 M

Désignation		Réf.
TRANSPARENT	4x7,5 mm	1418
NOIR	4x7,6 mm	1419
ELASTOMERE	4x7,6 mm	293881
JAUNE TRANSPARENT	5x8 mm	489462
ROSE TRANSPARENT	5x8 mm	489460
ROUGE TRANSPARENT	5x8 mm	489463
TRANSPARENT ULTRA SOUPLE	5x8 mm	507025
VERT TRANSPARENT	5x8 mm	489465
TRANSPARENT	5x8,5 mm	1421
NOIR	5x8,6 mm	1420
NEOPRENE ELASTOMERE	5x8,6 mm	441906
TRANSPARENT ULTRA SOUPLE	6X9,5 mm	512342
NOIR	6X9,6 mm	1422
NOIR	7x11 mm	320757
NOIR	8x12 mm	320803

/ DURITE ESSENCE 5 M

Désignation		Réf.
TRANSPARENT SPECIAL SOLEX	8x12 mm	493406



/ DURITE ESSENCE 5X8

Désignation	TUN'R
BLANC	478262
BLEU	487293
GRIS	478265
JAUNE FLUO	478267
NOIR	483687
ORANGE FLUO	478268
ROSE FLUO	479280
ROUGE	478263
TRANSPARENT	479180
VERT FLUO	478266
VIOLET	479178

/ FILTRE ESSENCE

Désignation	Réf.
FILTRE ESSENCE CYCLO/MECABOITE/MOTO/ MOTOCULTURE DIAMETRE 6 MM ET 8 MM	483724
FILTRE ESSENCE EMBOUTS ACIER (D6)	484517

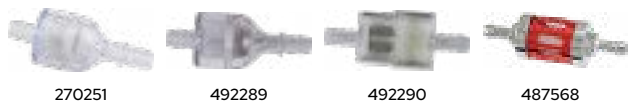



270251 492289 492290 487568



/ FILTRE ESSENCE

Désignation	Réf.
TRANSPARENT CYLINDRIQUE D6	270251
TRANSPARENT CYLINDRIQUE D6 (BOITE DE 50)	492289
TRANSPARENT PAPIER RECTANGULAIRE D6 (BOITE DE 50)	492290
TRANSPARENT/CHROME INSERT ALU CNC ROUGE CYLINDRIQUE (D8)	487568



/ FILTRE ESSENCE



484093

Désignation	Réf.
RECTANGULAIRE D6 MM	484093
RECTANGULAIRE D 6 MM (BOITE DE 50)	484424



1396 1395 492288 504628 270247



/ FILTRE ESSENCE

Désignation	Réf.
FILTRE ESSENCE D8	1396
ROND D5/6 (FILTRE PAPIER)	1395
ROND D6 (BOITE DE 50)	492288
TRANSPARENT CONIQUE (D6)	504628
TRANSPARENT CONIQUE (D6)	270247



510991



504160



504228

/ ROBINET ESSENCE MECABOITE/MOTO

Désignation	MASH	RIEJU
50 FIFTY/DIRT TRACK/125 CAFE RACER/SCRAMBLER	510991	
50 MRT/MRX/SMX/125 MARATHON (0/000.370.0500)		504160
50/125 RS2/RS3 (0/000.370.7000) AVEC SONDE		504228



487820 503893 490630 491120
484648 484647 484562 503892

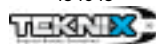

/ FILTRE ESSENCE MAXI SCOOTER

Désignation	Réf.
ADAPT. 125 HONDA PCX	487820
ADAPT. 125 HONDA SH 2013->2017	503893
ADAPT. 125 VESPA/PIAGGIO GTV/X9/X8/BEVERLY	490630
ADAPT. 125/150/300 HONDA SH ->2010	491120
ADAPT. 125/250 MAJESTY/SKYLINER	484648
ADAPT. 125/250 PIAGGIO X9/X9 EVO/BEVERLY	484647
ADAPT. 125/500/530 TMAX/XMAX/MP3/BURGMAN/OVETTO 4 TEMP	484562
ADAPT. 500 PIAGGIO MP3/X9/BEVERLY	503892



/ FILTRE ESSENCE

Désignation	Réf.
ROND TRANSPARENT D.6	477637
ROND TRANSPARENT D.8	477638



/ POMPE À ESSENCE



493878 502186

Désignation	Réf.
ADAPT. 500 PIAGGIO MP3/X9/BEVERLY	493878
ADAPT. 530 YAMAHA TMAX 2017->	502186



/ POMPE À ESSENCE

Désignation	Réf.
POMPE A ESSENCE UNIVERSEL POLINI	496331





/ DURITE MISE A L'AIR

Désignation	Réf.
DURITE MISE A L'AIR SOUPLE 3X5 (10 METRES)	519193



506946

285477

506947

/ DURITE HUILE

Désignation	Réf.
DURITE HUILE 2X5 NOIR (10 METRES)	506946
DURITE HUILE 3X5 (10 METRES)	285477
DURITE HUILE 3X6 NOIR (10 METRES)	506947



210387



494862



/ DURITE POMPE A HUILE

Désignation	Réf.
DURITE HUILE 2X4 (10 METRES)	210387
DURITE HUILE 3X6 (10 METRES)	494862



484326



494136

/ RACCORD CORRECTEUR EN T

Désignation	Réf.
POUR DURITE ESSENCE/AIR D 6	484326
POUR DURITE ESSENCE/AIR D 8	494136



/ REGULATEUR PRESSION INJECTION

Désignation	Réf.
3.5 BARS MAXI SCOOTER ADAPT. TMAX 500/530/OVETTO	488120



510399



491485

/ ARBRE A CAME

Désignation	MBK/ YAMAHA	TOP PERFORMANCES
ARBRE A CAME MAXI SCOOTER OEM 125 XMAX/SKYCRUISER/ EVOLIS/YZF/MT (1B9WE2110100)	510399	
ARBRE A CAME MAXI SCOOTER TOP PERF ADAPT. 125 XMAX/ SKYCRUISER/EVOLIS/YZF ->16		491485



511627



510396

/ DEMI COQUILLE SOUPAPE MAXI SCOOTER

Désignation	Réf.
125 MAJESTY/XMAX/SKYLINER ->2013 (1WG1211800) (X1)	511627
125 XMAX/SKYCRUISER 2014-> 3SOE2118000 (X1)	510396



/ GOUJON CYLINDRE MAXI SCOOTER

Désignation	Réf.
125 XMAX/MBK SKYCRUISER (9011608021000)	510476



511630



510406

/ JOINT TENDEUR CHAINE DE DISTRIBUTION

Désignation	Réf.
125 MAJESTY/SKYLINER (4RF122130000)	511630
125 XMAX/MBK SKYCRUISER (1DYE22130000)	510406



510374



510372

/ JOINT COUVERCLE CULASSE

Désignation	Réf.
125 XMAX/MBK SKYCRUISER (5YPE11930000)	510372
125 XMAX/MBK SKYCRUISER (9043006X0000)	510374



511626 510393

/ JOINT QUEUE SOUPAPE MAXI SCOOTER

Désignation	Réf.
125 MAJESTY/MBK SKYLINER (4TE12119000)	511626
125 YAMAHA XMAX/MBK SKYCRUISER (1PAE21190000)	510393



/ COUPELLE RESSORT SOUPAPE

Désignation	Réf.
MAXI SCOOTER OEM 125 XMAX/MBK SKYCRUISER (5YPE21260000)	510395



/ SOUPAPE ADMISSION

Désignation	Réf.
MAJESTY/MBK SKYLINER (5DSI211100)	511624
XMAX/MBK SKYCRUISER/YZF/MT (5YPE21110000)	510390



/ SOUPAPE ECHAPPEMENT

Désignation	Réf.
MAJESTY/MBK SKYLINER (5DSI212100)	511625
XMAX/MBK SKYCRUISER/YZF/MT (1B9E21210000)	510391



/ PION CENTRAGE CULASSE

Désignation	Réf.
XMAX/MBK SKYCRUISER/YZF/MT (9181014X0000)	510375



/ VIS REGLAGE JEU SOUPAPE MAXI SCOOTER

Désignation	Réf.
125 XMAX/MBK SKYCRUISER/YZF/MT - 2DM12	510397



/ GOUJON POT MAXI SCOOTER

Désignation	Réf.
125 XMAX/MBK SKYCRUISER (9011608X0500)	510371



/ RONDELLE CUIVRE JOINT CULASSE

Désignation	Réf.
MAXI SCOOTER OEM 125 XMAX (9043006X0000)	510370
MAXI SCOOTER OEM 125 XMAX (9020108X2100)	510373



/ JOINT CULASSE

Désignation	Réf.
MAXI SCOOTER OEM 125 MAJESTY/SKYLINER (5DSE118100)	511623



/ JOINT CYLINDRE/EMBASE

Désignation	Réf.
MAXI SCOOTER OEM 125 XMAX/SKYCRUISER/YZF (1B9113510000)	510377
MAXI SCOOTER OEM 125/150 MAJESTY/SKYLINER/DOODOO/TEOS/THUNDER (5DSI135100)	511622

/ CHAINE DE DISTRIBUTION

Désignation	SELECTION CGN MOTORISE	MBK/YAMAHA
MAXI SCOOTER ADAPT. 125 CHINOIS 4T/152QMB (90 MAILLONS)	468826	
MAXI SCOOTER OEM 125 YAMAHA MAJESTY/MBK SKYLINER (945914809400)		511628
MAXI SCOOTER OEM 125 YAMAHA XMAX/MBK SKYCRUISER (94568A809600)		510401



/ TENDEUR CHAINE DE DISTRIBUTION

Désignation	Réf.
XMAX/MBK SKYCRUISER (5LWE22100000)	510403

CULASSE / CYLINDER HEAD



/ CYLINDRE



510376



521007

Désignation	Réf.
CYLINDRE MAXI SCOOTER OEM 125 XMAX/SKYCRUISER/EVOLIS/YZF R/MT/WR (5D7E13110000) NU	510376
CYLINDRE MAXI SCOOTER OEM 125 XMAX/SKYCRUISER/EVOLIS/YZF R/MT/WR €3/€4(1B9WE13A1000)	521007



/ CYLINDRE ALU

Désignation	Réf.
CYLINDRE MAXI SCOOTER ALU TEKNIX ADAPT. 125 XMAX/SKYCRUISER/YZF 2006->	518717
CYLINDRE MAXI SCOOTER ALU TEKNIX CHEMISE FONTE ADAPT. 125 HONDA FORZA 2015 ->	513639
CYLINDRE MAXI SCOOTER ALU TEKNIX ADAPT. 125 SCOOT CHINOIS 4 TEMPS/152QMI	478898
CYLINDRE MAXI SCOOTER ALU TEKNIX CHEMISE FONTE ADAPT. 125 PCX 12->/SH START AND STOP 13->	498782
CYLINDRE MAXI SCOOTER ALU TEKNIX CHEMISE FONTE ADAPT. 125 SYMPHONY/FIDDLE/TWEET/DJANGO	502120
CYLINDRE QUAD ALU TEKNIX ADAPT. GY6 / CHINOIS - 150 CC	502134



/ CYLINDRE ALU CHEMISE FONTE

Désignation	Réf.
CYLINDRE MOTO ALU CHEMISE FONTE ADAPT. 125 AM60/AM64/ARCHIVE/HONDA CBF	506282
CYLINDRE MOTO ALU CHEMISE FONTE ADAPT. 125 SUZUKI GS/GN/DR/BULLIT/MASH/157 FMI (DIA 57MM)	506280
CYLINDRE MOTO ALU CHEMISE FONTE ADAPT. 125 TANGO/YBR/RS2/MRT/TANGO/DERBI SENDA/XTR/XTX	506278
CYLINDRE MOTO ALU CHEMISE FONTE ADAPT. 150 SUZUKI GS/GN/DR/ MOTEUR K157FMI (DIA 62MM)	506281
CYLINDRE MOTO ALU CHEMISE FONTE ADAPT. 150 TANGO/YBR/RS2/MRT/TANGO/DERBI SENDA/XTR/XTX	506279
CYLINDRE MOTO ALU CHEMISE FONTE ADAPT. 125 BRIXTON 4 TEMPS A PARTIR DE 2016	526072



496219



483640



496217



483424



496216



/ CYLINDRE ALU NIKASIL

Désignation	Réf.
CYLINDRE MAXI SCOOTER ALU AIRSAL NIKASIL ADAPT. 125 BURGMAN 2007-2016 (MADE IN CEE)	496219
CYLINDRE MAXI SCOOTER ALU AIRSAL NIKASIL ADAPT. 125 HONDA SH -> 2012 (MADE IN CEE)	483640
CYLINDRE MAXI SCOOTER ALU AIRSAL NIKASIL ADAPT. 125 HONDA SH/PCX 2012-> (MADE IN CEE)	496217
CYLINDRE MAXI SCOOTER ALU AIRSAL NIKASIL ADAPT. 125 XMAX/SKYCRUISER/YZF (MADE IN CEE)	483424
CYLINDRE MAXI SCOOTER ALU AIRSAL NIKASIL ADAPT. 125 XMAX/SKYCRUISER/YZF (MADE IN CEE)	496216



485398



510337



526072



/ CYLINDRE FONTE

Désignation	Réf.
CYLINDRE MAXI SCOOTER FONTE TEKNIX ADAPT. 125 MAJESTY/SKYLINER	485398
CYLINDRE MAXI SCOOTER FONTE TEKNIX ADAPT. 125 PIAGGIO BEVERLY/MP3/X7/X8/X9	510337
CYLINDRE MOTO ALU CHEMISE FONTE ADAPT. 125 BRIXTON 4 TEMPS A PARTIR DE 2016	526072



/ JOINT CULASSE

Désignation	Réf.
JOINT CULASSE SCOOTER OEM SYM ORBIT II/JET 4/MASK - 2 TEMPS (12251-T5C-000)	510794



/ JOINT HAUT MOTEUR MAXI SCOOTER

Désignation	Réf.
JOINT H.M. MAXI SCOOTER TEKNIX ADAPT. 125 XMAX/SKYCRUISER/YZF (POCHETTE) (CYL. ALU)	482221



MOTEUR

CYCLE

PNEUMATIQUE

ATELIER

ACCESSOIRES

ÉLECTRICITÉ

FILTRATION

FREINAGE

TRANSMISSION

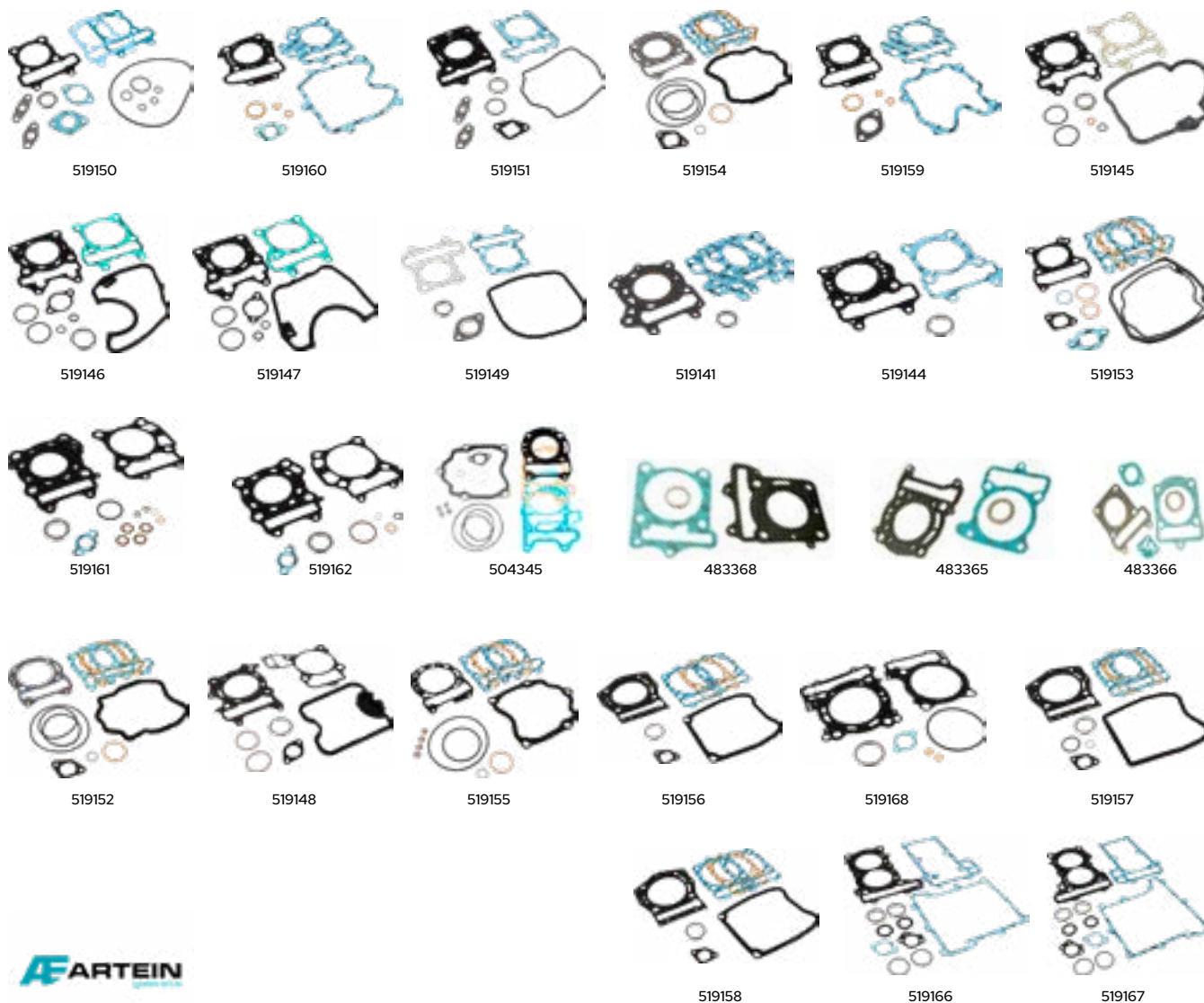

/ JOINT HAUT MOTEUR MAXI SCOOTER

Désignation	Réf.
ADAPT. 125 AGILITY/R16/LIKE/MOVIÉ/PEOPLE/PACIFIC/CIÁK	519150
ADAPT. 125 CITYSTAR 09->/SATELIS 04->/ABS 04->/GEOPOLIS 07->	519160
ADAPT. 125 DINK 06-07/G-DINK 11->/GRANDDINK 06-07/WINKER	519151
ADAPT. 125 DNA 4T 01->/RUNNER 00-02/HEXAGON GTX 00>/X9 01-02	519154
ADAPT. 125 ELYSEO 03->/ELYSTAR 04-07/JETFORCE 04-07	519159
ADAPT. 125 HONDA PCX 2010-2011	519145
ADAPT. 125 HONDA PCX 2012->	519146
ADAPT. 125 HONDA SH125I 2013-2016	519147
ADAPT. 125 KEEWAY ARN/FOCUS/MATRIX	519149
ADAPT. 125 LEONARDO 96-01/LEONARDO ST 01-04/SCARABEO 99-03	519141
ADAPT. 125 SH125I 06-12/S-WING FES/DYLAN/PANTHEON/SHI	519144
ADAPT. 125 SPORT CITY ONE 08-10/LOOXOR 02-03/FLY 05-10/ZIP	519153
ADAPT. 125 SUZUKI BURGMAN 2002-2006	519161

Désignation	Réf.
ADAPT. 125 SUZUKI BURGMAN 2007->	519162
ADAPT. 125 MP3 07-08/GRANTURISMO 07-09/XEVO/X8/X9 05-07	504345
ADAPT. 125 KYMCO DINK (POCHETTE)	483368
ADAPT. 125 MAJESTY/SKYLINER (POCHETTE)	483365
ADAPT. 125 FLAME/CYGNUS (POCHETTE)	483366
ADAPT. 180 DNA 01->/RUNNER 00-01/HEXAGON GTX 00->/X9 AMALFI	519152
ADAPT. 300 HONDA SH 2007-2014/FORZA 300IE ->2015	519148
ADAPT. 300 MP3/VESPA GTS/GTV/BEVERLY/SCARABEO/NEXUS	519155
ADAPT. 400 X-EVO 07-11/X8 06-08/MP3 07-08/MP3 LT 09->	519156
ADAPT. 400 YAMAHA MAJESTY 2004-2013/400XMAX 2014-2015	519168
ADAPT. 500 ATLANTIC 01-04/SCARABEO 03-06/X9 01-02	519157
ADAPT. 500 FUOCO 07-13/NEXUS 03-11/MP3 RT-LT 12->/X9 EVO	519158
ADAPT. 500 YAMAHA TMAX 2001-2012	519166
ADAPT. 530 YAMAHA TMAX 2012-2016	519167



/ JOINT HAUT MOTEUR MAXI SCOOTER



486018



486015

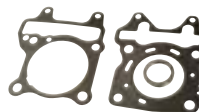

486016

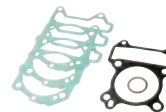

486017

Désignation	Réf.
ADAPT. 125 BURGMAN UH 2007 -> (CULASSE+EMBASE+ECHAPPEMENT)	486018
ADAPT. 125 HONDA PCX 2010-2011 (CULASSE+EMBASE+ECHAPPEMENT)	486015
ADAPT. 125 HONDA PCX 2012 -> (CULASSE+EMBASE+ECHAPPEMENT)	486016
ADAPT. 125 VESPA LX 4 TEMPS 2006->2012 (CULASSE+EMBASE+ECHA)	486017



519139



519140



519142



519143



519165



519163



519164



/ JOINT HAUT MOTEUR MOTO

Désignation	Réf.
ADAPT. 125 APRILIA AF1/FUTURA/SPORT CITY/PEGASO ->95/RED ROSE/EUROPA	519139
ADAPT. 125 APRILIA RS/RX/SPORT/REPLICA 95->/PEGASO 95->/TUONO 03-05	519140
ADAPT. 125 CAGIVA MITO 1987->/SUPERCITY/PLANET/N90/TAMANACO/FRECCIA	519142
ADAPT. 125 HONDA CA/REBEL	519143
ADAPT. 125 YAMAHA DT R/TDR/DERBI GPR 125 2T EURO2	519165
ADAPT. 125 YAMAHA TZR R/RR	519163
ADAPT. 125 YAMAHA YBR/RIEJU MRX/SMX 2007->	519164



/ JOINT HAUT MOTEUR MOTO



506412



506413



506415



506414



506416

Désignation	Réf.
ALU ADAPT. 125 AM60/AM64/ARCHIVE/HONDA CBF	506412
JADAPT. 125 SUZUKI GS/GN/DR/BULLIT/MASH/157 FMI (57 MM)	506413
ADAPT. 125 TANGO/YBR/RS2/MRT/TANGO/DERBI SENDA/XTR/XTX (DIA 54MM)	506415
ADAPT. 150 SUZUKI GS/GN/DR/BULLIT/MASH/157 FMI (DIA 62MM)	506414
ADAPT. 150 TANGO/YBR/RS2/MRT/TANGO/DERBI SENDA/XTR/XTX (DIA 57.4MM)	506416

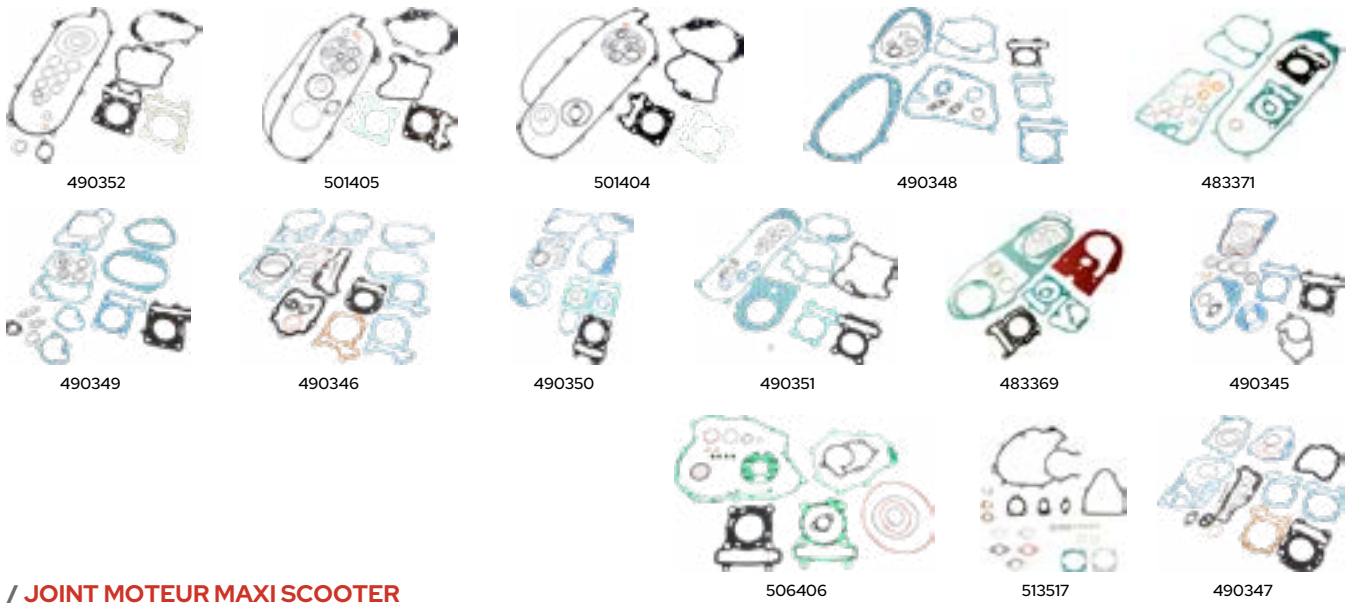

/ JOINT MOTEUR MAXI SCOOTER

Désignation	ARTEIN	ATHENA	SELECTION CGN MOTORISE
ADAPT. 125 HONDA PCX 2010-2011	490352		
ADAPT. 125 HONDA PCX 2012->	501405		
ADAPT. 125 HONDA SH I 2013-2016	501404		
ADAPT. 125 KYMCO AGILITY EURO3/PEOPLE	490348		
ADAPT. 125 KYMCO DINK EURO2	483371		
ADAPT. 125 KYMCO DINK/GRAND DINK EURO3	490349		
ADAPT. 125 MP3 07-08/GRANTURISMO 07-09/XEVO/X8/X9 05-07	490346		
ADAPT. 125 SYM GTS/JOYRIDE/HD	490350		
ADAPT. 125 TWEET/SYMPHONY/JET 4/EURO MX	490351		
ADAPT. 125 YAMAHA MAJESTY/MBK SKYLINER	483369		
ADAPT. 125 YAMAHA XMAX/MBK SKYCRUISER	490345		
ADAPT. 125 PIAGGIO X7 EVO IE/BEVERLY 2008-2010	490347		
ADAPT. 500 YAMAHA TMAX 2001->2012	501406		
ADAPT. VESPA 50/90/125 (25 PIECES)		513517	
ADAPT. 500/530 YAMAHA TMAX (COMPLET)			486024



/ PISTON

Désignation	AIRSAL	MB/ YAMAHA	TEKNIX
PISTON MAXI SCOOTER AIRSAL ADAPT. 125 HONDA SH ->12 (MADE IN CEE)	496224		
PISTON MAXI SCOOTER AIRSAL ADAPT. 125 HONDA SHI/PCX 12 ->	496227		
PISTON MAXI SCOOTER AIRSAL ADAPT. 125 SUZUKI BURGMAN 2007-2016	496230		
PISTON MAXI SCOOTER AIRSAL ADAPT. 125 XMAX/SKYCRUISER/YZF - (POUR CYL AIRSAL T6)	496232		
PISTON MAXI SCOOTER AIRSAL ADAPT. 125 XMAX/SKYCRUISER/YZF-R/MT	496234		
PISTON MAXI SCOOTER OEM 125 YAMAHA XMAX/MBK SKYCRUISER (5D7E16311000) NU		510386	
PISTON MAXI SCOOTER TEKNIX ADAPT. 125 XMAX/SKYCRUISER/YZF (CYL ALU)			482201



/ CLIPS DE PISTON



Désignation	Réf.
CLIPS PISTON MAXI SCOOTER OEM 125 YAMAHA XMAX/MBK SKYCRUISER - 934501611500	510388



/ AXE DE PISTON



Désignation	Réf.
AXE PISTON MAXI SCOOTER OEM 125 YAMAHA XMAX/MBK SKYCRUISER - 5YPE1633000	510387



/ BANDE THERMIQUE CALORIFUGE



Désignation	Réf.
BANDE THERMIQUE CALORIFUGE NOIR STAGE6 POUR ÉCHAPPEMENT (ROULEAU 25MMX3800MM)	518599



/ BANDE THERMIQUE FIBRE DE VERRE



Désignation	Réf.
BANDE THERMIQUE FIBRE DE VERRE ECHAPPEMENT BLANC (ROULEAU DE 1M - LARGEUR 50MM)	496875



/ COLLIER ECHAPPEMENT POT MOTO INOX



Désignation	Réf.
23-25 MM (X1)	504453
26-28 MM (X1)	504454
29-31 MM (X1)	503354
32-35 MM (X1)	504455
36-39 MM (X1)	504456
40-43 MM (X1)	504457
44-47 MM (X1)	504458
48-51 MM (X1)	504459
52-55 MM (X1)	504460



/ ECROU FIXATION



Désignation	Réf.
ECROU FIXATION POT MAXI SCOOTER/MOTO OEM 125 XMAX/SKYCRUISER/EVOLIS/YZF 9018508169000	510438

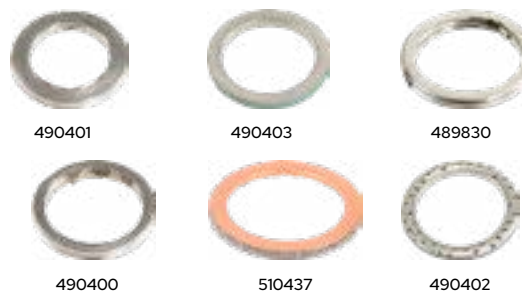

/ JOINT POT

Désignation	TEKNIX	MBK/ YAMAHA
MAXI SCOOTER (31X40X3)	489830	
MAXI SCOOTER ADAPT. 125 HONDA PCY/ KYMCO DINK/GRAND DINK (26X33X3.5)	490400	
MAXI SCOOTER ADAPT. 125 YAMAHA MAJESTY/MBK FLAME	490401	
MAXI SCOOTER ADAPT. 500 YAMAHA TMAX 2001 A 2011 (30X39X4)	490403	
MAXI SCOOTER/MOTO OEM 125 XMAX/ SKYCRUISER/EVOLIS/YZF (3YF146130100)		510437
MAXI SCOOTER/MOTO ADAPT. 125 XMAX/ SKYCRUISER/EVOLIS/YZF/RS3 (32X42X3)	490402	



/ JOINT POT



Désignation	Réf.
JOINT POT SILENCIEUX MAXI SCOOTER/MOTO OEM 125 XMAX/SKYCRUISER/EVOLIS/YZF 1B9147140000	510435

CYLINDRE & ÉCHAPPEMENT / CYLINDER & EXHAUST



1646

504613



/ LAINE SILENCIEUX/CARTOUCHE CERAMIQUE

Désignation	Réf.
300X300X13 (SACHET) FABR. FRANCAISE	1646
445X350X25MM - 4 TEMPS (SACHET)	504613



/ LAINE SILENCIEUX/CARTOUCHE FIBRE DE VERRE

Désignation	Réf.
500X700X13 (SACHET) FABR. FRANCAISE	483726



/ LAINE SILENCIEUX/CARTOUCHE ROCHE

Désignation	Réf.
LAINE SILENCIEUX/CARTOUCHE ROCHE 260MM DIAMETRE EXTERIEUR 54MM/INTERIEUR 20MM	512234



519173

519174

519175

519171

519172

519169

519170

512220

512219

/ PLAQUE PARE CHALEUR

Désignation	ARTEIN	SELECTION CGN MOTORISE
PLAQUE PARE CHALEUR ADHESIVE ARTEIN (140X195MM EPAISSEUR 0,80MM)	519173	
PLAQUE PARE CHALEUR ADHESIVE ARTEIN (140X195MM EPAISSEUR 1,60MM)	519174	
PLAQUE PARE CHALEUR ADHESIVE ARTEIN (195X475MM - LOT DE 2 EPAISSEUR 0,80 + 1,60MM)	519175	
PLAQUE PARE CHALEUR ADHESIVE ARTEIN (195X475MM EPAISSEUR 0,80MM)	519171	
PLAQUE PARE CHALEUR ADHESIVE ARTEIN (195X475MM EPAISSEUR 1,60MM)	519172	
PLAQUE PARE CHALEUR ADHESIVE ARTEIN (300X450MM EPAISSEUR 0,80MM)	519169	
PLAQUE PARE CHALEUR ADHESIVE ARTEIN (300X450MM EPAISSEUR 1,60MM)	519170	
PLAQUE PARE CHALEUR ADHESIVE EN TISSU/ALUMINIUM (200X150MM) (XI)		512220
PLAQUE PARE CHALEUR ADHESIVE EN TISSU/ALUMINIUM (250X200MM) (XI)		512219



/ SONDE

Désignation	Réf.
SONDE LAMBDA MAXI SCOOTER/MOTO OEM 125 XMAX/SKYCRUISER/EVOLIS/YZF 1B98592A0000	510439



/ SILENTBLOC POT/ECHAPPEMENT

Désignation	Réf.
SILENTBLOC POT/ECHAPPEMENT MECABOITE/MOTO ARIETE M6X20 MALE-FEMELLE (XI)	521301
SILENTBLOC POT/ECHAPPEMENT MECABOITE/MOTO ARIETE M8X20 MALE-MALE (XI)	521302



521301



521302



/ PROTECTION POT

Désignation	Réf.	
PROTECTION POT MAXI SCOOTER OEM 125 YAMAHA XMAX/MBK SKYCRUISER (2DME47180000)	510436	



/ RESSORT

Désignation	Réf.
RESSORT POT DIAM 10 - 1.60X55 (XI)	472641
RESSORT POT DIAM 10 - 1.60X60 (XI)	472602
RESSORT POT DIAM 10 - 1.80X55 (XI)	1743
RESSORT POT DIAM 10 - 2.00X61 (XI)	1744
RESSORT POT DIAM 10 - 53MM (XI) CHROME	512235
RESSORT POT DIAM 10 - 57MM (XI) NOIR	504621
RESSORT POT DIAM 10 - 57MM (XI) OR - AVEC ATTACHE PIVOTANTE	504624
RESSORT POT DIAM 10 - 62MM (XI) CHROME	512233
RESSORT POT DIAM 10 - 75MM (XI) NOIR	504622
RESSORT POT DIAM 10 - 75MM (XI) OR - AVEC ATTACHE PIVOTANTE	504626
RESSORT POT DIAM 10 - 83MM (XI) OR - AVEC ATTACHE PIVOTANTE	504625
RESSORT POT DIAM 10 - 90MM (XI) NOIR	504623
RESSORT POT DIAM 10 - 90MM (XI) OR - AVEC ATTACHE PIVOTANTE	504627



MOTEUR

CYCLE

PNEUMATIQUE

ATELIER

ACCESSOIRES

ÉLECTRICITÉ

FILTRATION

FREINAGE

TRANSMISSION

Modèle	Cylindre	Année début	Année fin		Description	Matériau enveloppe	Réf.
APRILIA							
RS4 125	125	2011	2016	LV ONE EVO	SLIP-ON	ACIER INOX	524863
RS 125/REPLICA GP	125	2017	2020	LV ONE EVO	SLIP-ON	ACIER INOX	524863
TUONO 125	125	2017	2020	LV ONE EVO	SLIP-ON	ACIER INOX	524863
TUAREG 660	660	2022		LV ONE EVO	SLIP-ON	ACIER INOX	525137
TUAREG 660	660	2022		LV ONE EVO BLACK EDITION	SLIP-ON	ACIER INOX	525138
SRV 850	850	2012	2016	LV ONE EVO	SLIP-ON	ACIER INOX	498875
APRILIA							
RS4 125	125	2011	2016	LV ONE EVO	SLIP-ON	ACIER INOX	524863
RS 125/REPLICA GP	125	2017	2020	LV ONE EVO	SLIP-ON	ACIER INOX	524863
TUONO 125	125	2017	2020	LV ONE EVO	SLIP-ON	ACIER INOX	524863
TUAREG 660	660	2022		LV ONE EVO	SLIP-ON	ACIER INOX	525137
TUAREG 660	660	2022		LV ONE EVO BLACK EDITION	SLIP-ON	ACIER INOX	525138
SRV 850	850	2012	2016	LV ONE EVO	SLIP-ON	ACIER INOX	498875
BENELLI							
TRK 502 X	500	2018	2022	LV ONE EVO	SLIP-ON	ACIER INOX	525007
LEONCINO/TRAIL 500	500	2017	2022	LV-10 BLACK EDITION	SLIP-ON	ACIER INOX	525185
LEONCINO/TRAIL 500	500	2017	2022	LV-10	SLIP-ON	ACIER INOX	525184
752 S	752	2019	2022	LV-10 FULL BLACK	SLIP-ON	ACIER INOX	525206
752 S	752	2019	2022	LV-10	SLIP-ON	ACIER INOX	525205
BMW							
F 650 GS	800	2008	2012	LV ONE EVO	SLIP-ON	ACIER INOX	524843
F 700 GS	800	2013	2016	LV ONE EVO	SLIP-ON	ACIER INOX	524843
F 800 GS/ADVENTURE	800	2008	2016	LV ONE EVO	SLIP-ON	ACIER INOX	524843
F 800 GT	800	2013	2016	LV ONE EVO	SLIP-ON	ACIER INOX	524844
F 800 R	800	2009	2016	LV ONE EVO	SLIP-ON	ACIER INOX	524844
F 800 GT	800	2013	2016	LV ONE EVO CARBON FIBER	SLIP-ON	FIBRE DE CARBONE	524845
F 800 R	800	2009	2016	LV ONE EVO CARBON FIBER	SLIP-ON	FIBRE DE CARBONE	524845
F 800 GT	800	2017	2020	LV ONE EVO	SLIP-ON	ACIER INOX	525062
F 800 R	800	2017	2020	LV ONE EVO	SLIP-ON	ACIER INOX	525062
F 800 GT	800	2017	2020	LV ONE EVO BLACK EDITION	SLIP-ON	ACIER INOX	525063
F 800 R	800	2017	2020	LV ONE EVO BLACK EDITION	SLIP-ON	ACIER INOX	525063
F 800 GT	800	2017	2020	LV ONE EVO CARBON FIBER	SLIP-ON	FIBRE DE CARBONE	525064
F 800 R	800	2017	2020	LV ONE EVO CARBON FIBER	SLIP-ON	FIBRE DE CARBONE	525064
F 700 GS	800	2017	2018	LV ONE EVO	SLIP-ON	ACIER INOX	525112
F 800 GS/ADVENTURE	800	2017	2018	LV ONE EVO	SLIP-ON	ACIER INOX	525112
F 700 GS	800	2017	2018	LV ONE EVO BLACK EDITION	SLIP-ON	ACIER INOX	525113
F 800 GS/ADVENTURE	800	2017	2018	LV ONE EVO BLACK EDITION	SLIP-ON	ACIER INOX	525113
F 700 GS	800	2017	2018	LV ONE EVO CARBON FIBER	SLIP-ON	FIBRE DE CARBONE	525114
F 800 GS/ADVENTURE	800	2017	2018	LV ONE EVO CARBON FIBER	SLIP-ON	FIBRE DE CARBONE	525114
F 750 GS	850	2018	2022	LV ONE EVO	SLIP-ON	ACIER INOX	524998
F 850 GS/ADVENTURE	850	2018	2022	LV ONE EVO	SLIP-ON	ACIER INOX	524998
F 750 GS	850	2018	2022	LV ONE EVO CARBON FIBER	SLIP-ON	FIBRE DE CARBONE	524999
F 850 GS/ADVENTURE	850	2018	2022	LV ONE EVO CARBON FIBER	SLIP-ON	FIBRE DE CARBONE	524999

Modèle	Cylindre	Année début	Année fin		Description	Matériau enveloppe	Réf.
F 750 GS	850	2018	2022	NERO	SLIP-ON	ACIER INOX	524889
F 850 GS/ADVENTURE	850	2018	2022	NERO	SLIP-ON	ACIER INOX	524889
F 900 R/XR	900	2020	2022	FACTORY S BLACK EDITION	SLIP-ON	ACIER INOX	525057
F 900 R/XR	900	2020	2022	FACTORY S TITANIUM	SLIP-ON	TITANE	525058
F 900 R/XR	900	2020	2022	FACTORY S CARBON FIBER	SLIP-ON	FIBRE DE CARBONE	525059
S 1000 R	1000	2021	2022	LV-10 BLACK EDITION	SLIP-ON	ACIER INOX	525187
S 1000 RR	1000	2019	2022	LV-10 BLACK EDITION	SLIP-ON	ACIER INOX	525187
S 1000 R	1000	2021	2022	LV-10 CARBON FIBER	SLIP-ON	FIBRE DE CARBONE	525188
S 1000 RR	1000	2019	2022	LV-10 CARBON FIBER	SLIP-ON	FIBRE DE CARBONE	525188
S 1000 R	1000	2021	2022	LV-10 FULL BLACK	SLIP-ON	ACIER INOX	525189
S 1000 RR	1000	2019	2022	LV-10 FULL BLACK	SLIP-ON	ACIER INOX	525189
S 1000 R	1000	2021	2022	LV-10 TITANIUM	SLIP-ON	TITANE	525190
S 1000 RR	1000	2019	2022	LV-10 TITANIUM	SLIP-ON	TITANE	525190
S 1000 XR	1000	2020	2022	LV-10 BLACK EDITION	SLIP-ON	ACIER INOX	525201
S 1000 XR	1000	2020	2022	LV-10 FULL BLACK	SLIP-ON	ACIER INOX	525202
S 1000 XR	1000	2020	2022	LV-10 TITANIUM	SLIP-ON	TITANE	525203
S 1000 R	1000	2021	2022	LV-10	SLIP-ON	ACIER INOX	525186
S 1000 RR	1000	2019	2022	LV-10	SLIP-ON	ACIER INOX	525186
S 1000 XR	1000	2020	2022	LV-10	SLIP-ON	ACIER INOX	525200
R 1200 GS	1200	2013	2016	LV ONE EVO	SLIP-ON	ACIER INOX	524869
R 1200 GS ADVENTURE	1200	2013	2016	LV ONE EVO	SLIP-ON	ACIER INOX	524869
R 1200 R	1200	2017	2018	FACTORY S	SLIP-ON	ACIER INOX	525001
R 1200 RS	1200	2017	2018	FACTORY S	SLIP-ON	ACIER INOX	525001
R 1200 R	1200	2017	2018	FACTORY S TITANIUM	SLIP-ON	TITANE	525002
R 1200 RS	1200	2017	2018	FACTORY S TITANIUM	SLIP-ON	TITANE	525002
R 1200 GS	1200	2013	2016	LV-12 BLACK EDITION	SLIP-ON	ACIER INOX	525211
R 1200 GS ADVENTURE	1200	2013	2016	LV-12 BLACK EDITION	SLIP-ON	ACIER INOX	525211
R 1200 GS	1200	2017	2018	LV-12 BLACK EDITION	SLIP-ON	ACIER INOX	525211
R 1200 GS ADVENTURE	1200	2017	2018	LV-12 BLACK EDITION	SLIP-ON	ACIER INOX	525211
R 1200 GS	1200	2013	2016	LV-12 TITANIUM	SLIP-ON	TITANE	525212
R 1200 GS ADVENTURE	1200	2013	2016	LV-12 TITANIUM	SLIP-ON	TITANE	525212
R 1200 GS	1200	2017	2018	LV-12 TITANIUM	SLIP-ON	TITANE	525212
R 1200 GS ADVENTURE	1200	2017	2018	LV-12 TITANIUM	SLIP-ON	TITANE	525212
R 1200 GS	1200	2013	2016	LV-12	SLIP-ON	ACIER INOX	525210
R 1200 GS ADVENTURE	1200	2013	2016	LV-12	SLIP-ON	ACIER INOX	525210
R 1200 GS	1200	2017	2018	LV-12	SLIP-ON	ACIER INOX	525210
R 1200 GS ADVENTURE	1200	2017	2018	LV-12	SLIP-ON	ACIER INOX	525210
R 1250 GS ADVENTURE	1250	2019	2022	LV-12 BLACK EDITION	SLIP-ON	ACIER INOX	525211
R 1250 GS	1250	2019	2022	LV-12 BLACK EDITION	SLIP-ON	ACIER INOX	525211
R 1250 GS	1250	2019	2022	LV-12 TITANIUM	SLIP-ON	TITANE	525212
R 1250 GS ADVENTURE	1250	2019	2022	LV-12 TITANIUM	SLIP-ON	TITANE	525212
R 1250 R/RS	1250	2019	2022	LV-12 BLACK EDITION	SLIP-ON	ACIER INOX	525226
R 1250 R/RS	1250	2019	2022	LV-12 TITANIUM	SLIP-ON	TITANE	525227
R 1250 GS	1250	2019	2022	LV-12	SLIP-ON	ACIER INOX	525210
R 1250 GS ADVENTURE	1250	2019	2022	LV-12	SLIP-ON	ACIER INOX	525210
R 1250 R/RS	1250	2019	2022	LV-12	SLIP-ON	ACIER INOX	525225

MOTEUR

CYCLE

PNEUMATIQUE

ATELIER

ACCESSOIRES

ÉLECTRICITÉ

FILTRATION

FREINAGE

TRANSMISSION

Modèle	Cylindre	Année début	Année fin		Description	Matériau enveloppe	Réf.
CF MOTO							
700 CL-X HERITAGE/SPORT	700	2021	2022	LV-10 BLACK EDITION	SLIP-ON	ACIER INOX	525197
700 CL-X HERITAGE/SPORT	700	2021	2022	LV-10 CARBON FIBER	SLIP-ON	FIBRE DE CARBONE	525198
700 CL-X HERITAGE/SPORT	700	2021	2022	LV-10 FULL BLACK	SLIP-ON	ACIER INOX	525199
700 CL-X HERITAGE/SPORT	700	2021	2022	LV-10	SLIP-ON	ACIER INOX	525196
800 MT SPORT/TOURING	800	2022		LV ONE EVO	SLIP-ON	ACIER INOX	525143
800 MT SPORT/TOURING	800	2022		LV ONE EVO BLACK EDITION	SLIP-ON	ACIER INOX	525144
DUCATI							
MONSTER 696	696	2008	2014	LV ONE EVO	2 SLIP-ON	ACIER INOX	524841
MONSTER 796	796	2010	2014	LV ONE EVO	2 SLIP-ON	ACIER INOX	524841
SCRAMBLER 800 ICON/CLASSIC	800	2015	2016	GP STYLE	SLIP-ON	ACIER INOX	524933
MONSTER 797	800	2017	2020	GP STYLE	SLIP-ON	ACIER INOX	524933
MONSTER 1100/S	1100	2009	2010	LV ONE EVO	2 SLIP-ON	ACIER INOX	524841
FANTIC MOTOR							
CABALLERO 125 SCRAMBLER/FLAT TRACK	125	2021	2022	GP DUALS	SLIP-ON	ACIER INOX	525167
CABALLERO 125 SCRAMBLER/FLAT TRACK	125	2021	2022	GP DUALS	SLIP-ON	ACIER INOX	525162
GAS GAS							
ES 700	700	2022		NERO	SLIP-ON	ACIER INOX	524911
SM 700	700	2022		NERO	SLIP-ON	ACIER INOX	524911
ES 700	700	2022		NERO	FULL SYSTEM	ACIER INOX	524913
SM 700	700	2022		NERO	FULL SYSTEM	ACIER INOX	524913
ES 700	700	2022		LV ONE EVO	SLIP-ON	ACIER INOX	525075
SM 700	700	2022		LV ONE EVO	SLIP-ON	ACIER INOX	525075
ES 700	700	2022		LV ONE EVO	SLIP-ON	ACIER INOX	525076
SM 700	700	2022		LV ONE EVO	SLIP-ON	ACIER INOX	525076
ES 700	700	2022		LV ONE EVO	FULL SYSTEM	ACIER INOX	525077
SM 700	700	2022		LV ONE EVO	FULL SYSTEM	ACIER INOX	525077
ES 700	700	2022		LV ONE EVO	FULL SYSTEM	ACIER INOX	525078
SM 700	700	2022		LV ONE EVO	FULL SYSTEM	ACIER INOX	525078
ES 700	700	2022		NERO	SLIP-ON	ACIER INOX	524910
SM 700	700	2022		NERO	SLIP-ON	ACIER INOX	524910
ES 700	700	2022		NERO	FULL SYSTEM	ACIER INOX	524912
SM 700	700	2022		NERO	FULL SYSTEM	ACIER INOX	524912
GILERA							
RUNNER ST 125	125	2008	2016	LV ONE EVO	FULL SYSTEM	ACIER INOX	524859
RUNNER VX 125	125	2006	2007	LV ONE EVO	FULL SYSTEM	ACIER INOX	524859
RUNNER ST 200	200	2008	2014	LV ONE EVO	FULL SYSTEM	ACIER INOX	524859
RUNNER VXR 200	200	2006	2008	LV ONE EVO	FULL SYSTEM	ACIER INOX	524859
GP 800	800	2008	2015	LV ONE EVO	SLIP-ON	ACIER INOX	498875
HONDA							
VT 125 C SHADOW	125	1999	2003	K02	FULL SYSTEM	ACIER CHROME	524826
XL 125 V VARADERO carburetor/injection	125	2001	2013	LV ONE	SLIP-ON	ACIER INOX	524864
FORZA 125	125	2015	2016	NERO	FULL SYSTEM	ACIER INOX	524876

Modèle	Cylindre	Année début	Année fin		Description	Matériau enveloppe	Réf.
FORZA 125	125	2017	2020	NERO	FULL SYSTEM	ACIER INOX	520965
SH 125i	125	2017	2019	NERO	FULL SYSTEM	ACIER INOX	524895
PCX 125	125	2018	2020	NERO	FULL SYSTEM	ACIER INOX	524897
SH 125i	125	2020	2022	NERO	FULL SYSTEM	ACIER INOX	524905
FORZA 125	125	2017	2020	NERO	FULL SYSTEM	ACIER INOX	524886
SH 125i	125	2017	2019	NERO	FULL SYSTEM	ACIER INOX	524896
FORZA 125	125	2021	2022	NERO	FULL SYSTEM	ACIER INOX	520966
PCX 125	125	2018	2020	NERO	FULL SYSTEM	ACIER INOX	524898
SH 125i	125	2020	2022	NERO	FULL SYSTEM	ACIER INOX	524904
FORZA 125	125	2021	2022	NERO	FULL SYSTEM	ACIER INOX	524918
PCX 125	125	2021	2022	NERO	FULL SYSTEM	ACIER INOX	524926
PCX 125	125	2021	2022	NERO	FULL SYSTEM	ACIER INOX	524927
CB 125 R Neo Sports Café	125	2018	2020	LV ONE EVO	FULL SYSTEM	ACIER INOX	524978
CB 125 R Neo Sports Café	125	2018	2020	LV ONE EVO	FULL SYSTEM	ACIER INOX	524979
CB 125 R Neo Sports Café	125	2018	2020	LV ONE EVO CARBON FIBER	FULL SYSTEM	FIBRE DE CARBONE	524980
CB 125 R Neo Sports Café	125	2018	2020	LV ONE EVO CARBON FIBER	FULL SYSTEM	FIBRE DE CARBONE	524981
SH 125i	125	2020	2022	LV ONE EVO	FULL SYSTEM	ACIER INOX	525053
SH 125i	125	2020	2022	LV ONE EVO	FULL SYSTEM	ACIER INOX	525054
FORZA 125	125	2021	2022	LV ONE EVO	FULL SYSTEM	ACIER INOX	525092
FORZA 125	125	2021	2022	LV ONE EVO	FULL SYSTEM	ACIER INOX	525093
PCX 125	125	2021	2022	LV ONE EVO	FULL SYSTEM	ACIER INOX	525124
PCX 125	125	2021	2022	LV ONE EVO	FULL SYSTEM	ACIER INOX	525125
CB 125 R Neo Sports Café	125	2021	2022	LV ONE EVO	FULL SYSTEM	ACIER INOX	525126
CB 125 R Neo Sports Café	125	2021	2022	LV ONE EVO	FULL SYSTEM	ACIER INOX	525127
CB 125 R Neo Sports Café	125	2021	2022	LV ONE EVO BLACK EDITION	FULL SYSTEM	ACIER INOX	525128
CB 125 R Neo Sports Café	125	2021	2022	LV ONE EVO BLACK EDITION	FULL SYSTEM	ACIER INOX	525129
CB 125 R Neo Sports Café	125	2021	2022	LV ONE EVO CARBON FIBER	FULL SYSTEM	FIBRE DE CARBONE	525130
CB 125 R Neo Sports Café	125	2021	2022	LV ONE EVO CARBON FIBER	FULL SYSTEM	FIBRE DE CARBONE	525131
SH 150i	150	2020	2022	NERO	FULL SYSTEM	ACIER INOX	524905
SH 150i	150	2020	2022	NERO	FULL SYSTEM	ACIER INOX	524904
SH 150i	150	2020	2022	LV ONE EVO	FULL SYSTEM	ACIER INOX	525053
SH 150i	150	2020	2022	LV ONE EVO	FULL SYSTEM	ACIER INOX	525054
CMX 300 REBEL	300	2017	2022	CLASSIC RACER BLACK EDITION	SLIP-ON	ACIER INOX	525153
ADV 350	350	2022		NERO	SLIP-ON	ACIER INOX	524922
SH 350i	350	2021	2022	NERO	SLIP-ON	ACIER INOX	524922
ADV 350	350	2022		NERO	SLIP-ON	ACIER INOX	524923
SH 350i	350	2021	2022	NERO	SLIP-ON	ACIER INOX	524923
ADV 350	350	2022		LV ONE EVO	SLIP-ON	ACIER INOX	525108
SH 350i	350	2021	2022	LV ONE EVO	SLIP-ON	ACIER INOX	525108
ADV 350	350	2022		LV ONE EVO	SLIP-ON	ACIER INOX	525109
SH 350i	350	2021	2022	LV ONE EVO	SLIP-ON	ACIER INOX	525109
FORZA 350	350	2021	2022	LV ONE EVO	SLIP-ON	ACIER INOX	525139
FORZA 350	350	2021	2022	LV ONE EVO	SLIP-ON	ACIER INOX	525140
FORZA 350	350	2021	2022	NERO	SLIP-ON	ACIER INOX	525152
FORZA 350	350	2021	2022	NERO	SLIP-ON	ACIER INOX	525151

Modèle	Cylindre	Année début	Année fin		Description	Matériau enveloppe	Réf.
CB 500 F	500	2016	2018	NERO	SLIP-ON	ACIER INOX	524885
CB 500 X	500	2017	2018	NERO	SLIP-ON	ACIER INOX	524885
CBR 500 R	500	2016	2018	NERO	SLIP-ON	ACIER INOX	524885
CB 500 F	500	2019	2021	NERO	SLIP-ON	ACIER INOX	524891
CB 500 X	500	2019	2022	NERO	SLIP-ON	ACIER INOX	524891
CBR 500 R	500	2019	2021	NERO	SLIP-ON	ACIER INOX	524891
CB 500 F	500	2016	2018	LV ONE EVO	SLIP-ON	ACIER INOX	524960
CB 500 X	500	2017	2018	LV ONE EVO	SLIP-ON	ACIER INOX	524960
CBR 500 R	500	2016	2018	LV ONE EVO	SLIP-ON	ACIER INOX	524960
CB 500 F	500	2019	2021	LV ONE EVO	SLIP-ON	ACIER INOX	525023
CB 500 X	500	2019	2022	LV ONE EVO	SLIP-ON	ACIER INOX	525023
CBR 500 R	500	2019	2021	LV ONE EVO	SLIP-ON	ACIER INOX	525023
CB 500 F	500	2019	2021	LV ONE EVO CARBON FIBER	SLIP-ON	FIBRE DE CARBONE	525024
CB 500 X	500	2019	2022	LV ONE EVO CARBON FIBER	SLIP-ON	FIBRE DE CARBONE	525024
CBR 500 R	500	2019	2021	LV ONE EVO CARBON FIBER	SLIP-ON	FIBRE DE CARBONE	525024
CMX 500 REBEL	500	2017	2021	CLASSIC RACER BLACK EDITION	SLIP-ON	ACIER INOX	525153
CBR 600 RR/ABS	600	2007	2012	LV ONE	SLIP-ON	ACIER INOX	524840
CBF 600 N	600	2005	2011	LV ONE EVO	SLIP-ON	ACIER INOX	524846
CBF 600 S	600	2004	2012	LV ONE EVO	SLIP-ON	ACIER INOX	524846
CB 600 F HORNET	600	2007	2013	LV ONE EVO	SLIP-ON	ACIER INOX	524849
CBR 600 F	600	2011	2013	LV ONE EVO	SLIP-ON	ACIER INOX	524849
CB 650 R Neo Sports Café	650	2019	2022	LV ONE EVO	FULL SYSTEM	ACIER INOX	525014
CB 650 R Neo Sports Café	650	2019	2022	LV ONE EVO CARBON FIBER	FULL SYSTEM	FIBRE DE CARBONE	525016
XL 700 V TRANSALP	700	2008	2013	LV ONE EVO	SLIP-ON	ACIER INOX	524850
INTEGRA 750/DCT/ABS	750	2016	2020	NERO	SLIP-ON	ACIER INOX	524880
NC 750 S/X/DCT/ABS	750	2016	2020	NERO	SLIP-ON	ACIER INOX	524880
X-ADV (Also fits A2 version)	750	2017	2022	NERO	SLIP-ON	ACIER INOX	524883
FORZA 750 (Also fits A2 version)	750	2021	2022	NERO	SLIP-ON	ACIER INOX	524883
XRV 750 AFRICA TWIN (Type RD07A-RD07B)	750	1995	2005	LV ONE EVO	SLIP-ON	ACIER INOX	524857
INTEGRA 750/DCT/ABS	750	2016	2020	LV ONE EVO	SLIP-ON	ACIER INOX	524955
NC 750 S/X/DCT/ABS	750	2016	2020	LV ONE EVO	SLIP-ON	ACIER INOX	524955
X-ADV (Also fits A2 version) (Fits with GIVI panniers)	750	2017	2022	LV PRO	SLIP-ON	ACIER INOX	524958
FORZA 750 (Also fits A2 version)	750	2021	2022	LV PRO	SLIP-ON	ACIER INOX	524958
X-ADV (Also fits A2 version) (Fits with GIVI panniers)	750	2017	2022	LV PRO CARBON FIBER	SLIP-ON	FIBRE DE CARBONE	524959
FORZA 750 (Also fits A2 version)	750	2021	2022	LV PRO CARBON FIBER	SLIP-ON	FIBRE DE CARBONE	524959
NC 750 X	750	2021	2022	LV ONE EVO	SLIP-ON	ACIER INOX	525121
NC 750 X	750	2021	2022	LV ONE EVO BLACK EDITION	SLIP-ON	ACIER INOX	525122
NC 750 X	750	2021	2022	LV ONE EVO CARBON FIBER	SLIP-ON	FIBRE DE CARBONE	525123
CBF 1000/ST	1000	2010	2013	LV ONE EVO	SLIP-ON	ACIER INOX	524851
CB 1000 R Neo Sports Café	1000	2018	2022	LV-10 BLACK EDITION	SLIP-ON	ACIER INOX	525179
CB 1000 R Neo Sports Café	1000	2018	2022	LV-10 FULL BLACK	SLIP-ON	ACIER INOX	525180
CB 1000 R Neo Sports Café	1000	2018	2022	LV-10 CARBON FIBER	SLIP-ON	FIBRE DE CARBONE	525181

Modèle	Cylindre	Année début	Année fin		Description	Matériau enveloppe	Réf.
CB 1000 R Neo Sports Café	1000	2018	2022	LV-10	SLIP-ON	ACIER INOX	525178
CRF 1100 L AFRICA TWIN/ ADVENTURE SPORT/DCT	1100	2020	2022	LV ONE EVO	SLIP-ON	ACIER INOX	525060
CRF 1100 L AFRICA TWIN/ ADVENTURE SPORT/DCT	1100	2020	2022	LV ONE EVO BLACK EDITION	SLIP-ON	ACIER INOX	525061
CRF 1100 L AFRICA TWIN/ ADVENTURE SPORT/DCT	1100	2020	2022	LV-12 BLACK EDITION	SLIP-ON	ACIER INOX	525214
CRF 1100 L AFRICA TWIN/ ADVENTURE SPORT/DCT	1100	2020	2022	LV-12 TITANIUM	SLIP-ON	TITANE	525215
NT 1100	1100	2022		LV-12 BLACK EDITION	SLIP-ON	ACIER INOX	525229
NT 1100	1100	2022		LV-12 TITANIUM	SLIP-ON	TITANE	525230
CRF 1100 L AFRICA TWIN/ ADVENTURE SPORT/DCT	1100	2020	2022	LV-12	SLIP-ON	ACIER INOX	525213
NT 1100	1100	2022		LV-12	SLIP-ON	ACIER INOX	525228
VFR 1200 X CROSSTOURER/DCT/XD	1200	2012	2015	LV ONE EVO	SLIP-ON	ACIER INOX	524862
HUSQVARNA							
SVARTPILEN 125	125	2021	2022	GP ONE	SLIP-ON	ACIER INOX	525161
VITPILEN 125	125	2021	2022	GP ONE	SLIP-ON	ACIER INOX	525161
SVARTPILEN 401	401	2018	2019	GP ONE	SLIP-ON	ACIER INOX	525159
VITPILEN 401	401	2018	2019	GP ONE	SLIP-ON	ACIER INOX	525159
SVARTPILEN 401	401	2020	2022	GP ONE	SLIP-ON	ACIER INOX	525161
VITPILEN 401	401	2020	2022	GP ONE	SLIP-ON	ACIER INOX	525161
701 ENDURO/LR	701	2017	2020	NERO	SLIP-ON	ACIER INOX	524900
701 SUPERMOTO	701	2017	2020	NERO	SLIP-ON	ACIER INOX	524900
701 SUPERMOTO	701	2021	2022	NERO	SLIP-ON	ACIER INOX	524914
701 ENDURO/LR	701	2021	2022	NERO	SLIP-ON	ACIER INOX	524914
701 SUPERMOTO	701	2021	2022	NERO	FULL SYSTEM	ACIER INOX	524916
701 ENDURO/LR	701	2021	2022	NERO	FULL SYSTEM	ACIER INOX	524916
701 ENDURO	701	2015	2016	LV ONE EVO	SLIP-ON	ACIER INOX	524848
701 SUPERMOTO	701	2015	2016	LV ONE EVO	SLIP-ON	ACIER INOX	524848
701 ENDURO/LR	701	2017	2020	LV ONE EVO	SLIP-ON	ACIER INOX	524848
701 SUPERMOTO	701	2017	2020	LV ONE EVO	SLIP-ON	ACIER INOX	524848
701 ENDURO/LR	701	2017	2020	NERO	SLIP-ON	ACIER INOX	524901
701 SUPERMOTO	701	2017	2020	NERO	SLIP-ON	ACIER INOX	524901
701 SUPERMOTO	701	2021	2022	NERO	SLIP-ON	ACIER INOX	524915
701 ENDURO/LR	701	2021	2022	NERO	SLIP-ON	ACIER INOX	524915
701 SUPERMOTO	701	2021	2022	NERO	FULL SYSTEM	ACIER INOX	524917
701 ENDURO/LR	701	2021	2022	NERO	FULL SYSTEM	ACIER INOX	524917
701 ENDURO/LR	701	2017	2020	LV ONE EVO	FULL SYSTEM	ACIER INOX	524975
701 SUPERMOTO	701	2017	2020	LV ONE EVO	FULL SYSTEM	ACIER INOX	524975
701 ENDURO/LR	701	2017	2020	LV ONE EVO	FULL SYSTEM	ACIER INOX	524976
701 SUPERMOTO	701	2017	2020	LV ONE EVO	FULL SYSTEM	ACIER INOX	524976
701 ENDURO/LR	701	2017	2020	LV ONE EVO	SLIP-ON	ACIER INOX	525029
701 SUPERMOTO	701	2017	2020	LV ONE EVO	SLIP-ON	ACIER INOX	525029
701 ENDURO/LR	701	2017	2020	LV ONE EVO	SLIP-ON	ACIER INOX	525030
701 SUPERMOTO	701	2017	2020	LV ONE EVO	SLIP-ON	ACIER INOX	525030
701 SUPERMOTO	701	2021	2022	LV ONE EVO	SLIP-ON	ACIER INOX	525085
701 ENDURO/LR	701	2021	2022	LV ONE EVO	SLIP-ON	ACIER INOX	525085
701 SUPERMOTO	701	2021	2022	LV ONE EVO	SLIP-ON	ACIER INOX	525086

Modèle	Cylindre	Année début	Année fin		Description	Matériau enveloppe	Réf.
701 ENDURO/LR	701	2021	2022	LV ONE EVO	SLIP-ON	ACIER INOX	525086
701 SUPERMOTO	701	2021	2022	LV ONE EVO	FULL SYSTEM	ACIER INOX	525087
701 ENDURO/LR	701	2021	2022	LV ONE EVO	FULL SYSTEM	ACIER INOX	525087
701 SUPERMOTO	701	2021	2022	LV ONE EVO	FULL SYSTEM	ACIER INOX	525088
701 ENDURO/LR	701	2021	2022	LV ONE EVO	FULL SYSTEM	ACIER INOX	525088
VITPILEN 701	701	2018	2020	GP DUALS	SLIP-ON	ACIER INOX	525160
SVARTPILEN 701	701	2019	2020	GP DUALS	SLIP-ON	ACIER INOX	525160
NORDEN 901	901	2022		LV ONE EVO	SLIP-ON	ACIER INOX	525143
NORDEN 901	901	2022		LV ONE EVO BLACK EDITION	SLIP-ON	ACIER INOX	525144
KAWASAKI							
NINJA 125	125	2019	2022	LV ONE EVO	SLIP-ON	ACIER INOX	525010
Z 125	125	2019	2022	LV ONE EVO	SLIP-ON	ACIER INOX	525010
NINJA 125	125	2019	2022	LV ONE EVO CARBON FIBER	SLIP-ON	FIBRE DE CARBONE	525011
Z 125	125	2019	2022	LV ONE EVO CARBON FIBER	SLIP-ON	FIBRE DE CARBONE	525011
KFX 400	400	2003	2006	X3	SLIP-ON	ALUMINIUM	524830
NINJA 400	400	2018	2021	LV ONE EVO	SLIP-ON	ACIER INOX	524993
NINJA 400	400	2022	2023	LV ONE EVO	SLIP-ON	ACIER INOX	524993
Z 400	400	2019	2021	LV ONE EVO	SLIP-ON	ACIER INOX	524993
Z 400	400	2022	2023	LV ONE EVO	SLIP-ON	ACIER INOX	524993
NINJA 400	400	2018	2021	LV ONE EVO CARBON FIBER	SLIP-ON	FIBRE DE CARBONE	524994
NINJA 400	400	2022	2023	LV ONE EVO CARBON FIBER	SLIP-ON	FIBRE DE CARBONE	524994
Z 400	400	2019	2021	LV ONE EVO CARBON FIBER	SLIP-ON	FIBRE DE CARBONE	524994
Z 400	400	2022	2023	LV ONE EVO CARBON FIBER	SLIP-ON	FIBRE DE CARBONE	524994
ZX-6R NINJA	636	2019	2020	LV ONE EVO	SLIP-ON	ACIER INOX	525021
ZX-6R NINJA	636	2019	2020	LV ONE EVO CARBON FIBER	SLIP-ON	FIBRE DE CARBONE	525022
KLR 650	650	1997	2022	X3	SLIP-ON	ALUMINIUM	524828
ER-6N/F/NINJA 650R	650	2006	2011	UNDERBODY	SLIP-ON	ACIER INOX	524836
VERSYS 650	650	2007	2014	UNDERBODY	SLIP-ON	ACIER INOX	524836
NINJA 650	650	2017	2019	UNDERBODY	FULL SYSTEM	ACIER INOX	524940
NINJA 650	650	2020	2020	UNDERBODY	FULL SYSTEM	ACIER INOX	524940
Z 650	650	2017	2019	UNDERBODY	FULL SYSTEM	ACIER INOX	524940
Z 650	650	2020	2020	UNDERBODY	FULL SYSTEM	ACIER INOX	524940
NINJA 650	650	2017	2019	UNDERBODY	FULL SYSTEM	ACIER INOX	524941
Z 650	650	2017	2019	UNDERBODY	FULL SYSTEM	ACIER INOX	524941
NINJA 650	650	2017	2019	LV ONE EVO	FULL SYSTEM	ACIER INOX	524947
NINJA 650	650	2020	2020	LV ONE EVO	FULL SYSTEM	ACIER INOX	524947
Z 650	650	2017	2019	LV ONE EVO	FULL SYSTEM	ACIER INOX	524947
Z 650	650	2020	2020	LV ONE EVO	FULL SYSTEM	ACIER INOX	524947
NINJA 650	650	2017	2019	LV ONE EVO	FULL SYSTEM	ACIER INOX	524948
NINJA 650	650	2020	2020	LV ONE EVO	FULL SYSTEM	ACIER INOX	524948
Z 650	650	2017	2019	LV ONE EVO	FULL SYSTEM	ACIER INOX	524948
Z 650	650	2020	2020	LV ONE EVO	FULL SYSTEM	ACIER INOX	524948
NINJA 650	650	2017	2019	LV ONE EVO CARBON FIBER	FULL SYSTEM	FIBRE DE CARBONE	524949

Modèle	Cylindre	Année début	Année fin		Description	Matériau enveloppe	Réf.
NINJA 650	650	2020	2020	LV ONE EVO CARBON FIBER	FULL SYSTEM	FIBRE DE CARBONE	524949
Z 650	650	2017	2019	LV ONE EVO CARBON FIBER	FULL SYSTEM	FIBRE DE CARBONE	524949
Z 650	650	2020	2020	LV ONE EVO CARBON FIBER	FULL SYSTEM	FIBRE DE CARBONE	524949
NINJA 650	650	2017	2019	LV ONE EVO CARBON FIBER	FULL SYSTEM	FIBRE DE CARBONE	524950
NINJA 650	650	2020	2020	LV ONE EVO CARBON FIBER	FULL SYSTEM	FIBRE DE CARBONE	524950
Z 650	650	2017	2019	LV ONE EVO CARBON FIBER	FULL SYSTEM	FIBRE DE CARBONE	524950
Z 650	650	2020	2020	LV ONE EVO CARBON FIBER	FULL SYSTEM	FIBRE DE CARBONE	524950
VERSYS 650	650	2017	2020	UNDERBODY	FULL SYSTEM	ACIER INOX	525028
NINJA 650	650	2021	2022	LV ONE EVO	FULL SYSTEM	ACIER INOX	525102
Z 650	650	2021	2022	LV ONE EVO	FULL SYSTEM	ACIER INOX	525102
Z 650 RS	650	2022		LV ONE EVO	FULL SYSTEM	ACIER INOX	525102
VERSYS 650	650	2021	2022	LV ONE EVO	FULL SYSTEM	ACIER INOX	525102
NINJA 650	650	2021	2022	LV ONE EVO	FULL SYSTEM	ACIER INOX	525103
Z 650	650	2021	2022	LV ONE EVO	FULL SYSTEM	ACIER INOX	525103
Z 650 RS	650	2022		LV ONE EVO	FULL SYSTEM	ACIER INOX	525103
VERSYS 650	650	2021	2022	LV ONE EVO	FULL SYSTEM	ACIER INOX	525103
NINJA 650	650	2021	2022	LV ONE EVO BLACK EDITION	FULL SYSTEM	ACIER INOX	525104
Z 650	650	2021	2022	LV ONE EVO BLACK EDITION	FULL SYSTEM	ACIER INOX	525104
Z 650 RS	650	2022		LV ONE EVO BLACK EDITION	FULL SYSTEM	ACIER INOX	525104
VERSYS 650	650	2021	2022	LV ONE EVO BLACK EDITION	FULL SYSTEM	ACIER INOX	525104
NINJA 650	650	2021	2022	LV ONE EVO BLACK EDITION	FULL SYSTEM	ACIER INOX	525105
Z 650	650	2021	2022	LV ONE EVO BLACK EDITION	FULL SYSTEM	ACIER INOX	525105
Z 650 RS	650	2022		LV ONE EVO BLACK EDITION	FULL SYSTEM	ACIER INOX	525105
VERSYS 650	650	2021	2022	LV ONE EVO BLACK EDITION	FULL SYSTEM	ACIER INOX	525105
NINJA 650	650	2021	2022	LV ONE EVO CARBON FIBER	FULL SYSTEM	FIBRE DE CARBONE	525106
Z 650	650	2021	2022	LV ONE EVO CARBON FIBER	FULL SYSTEM	FIBRE DE CARBONE	525106
Z 650 RS	650	2022		LV ONE EVO CARBON FIBER	FULL SYSTEM	FIBRE DE CARBONE	525106
VERSYS 650	650	2021	2022	LV ONE EVO CARBON FIBER	FULL SYSTEM	FIBRE DE CARBONE	525106
NINJA 650	650	2021	2022	LV ONE EVO CARBON FIBER	FULL SYSTEM	FIBRE DE CARBONE	525107
Z 650	650	2021	2022	LV ONE EVO CARBON FIBER	FULL SYSTEM	FIBRE DE CARBONE	525107
Z 650 RS	650	2022		LV ONE EVO CARBON FIBER	FULL SYSTEM	FIBRE DE CARBONE	525107
VERSYS 650	650	2021	2022	LV ONE EVO CARBON FIBER	FULL SYSTEM	FIBRE DE CARBONE	525107
VERSYS 650	650	2017	2020	UNDERBODY	FULL SYSTEM	ACIER INOX	525027
Z 750	750	2007	2014	NERO	SLIP-ON	ACIER INOX	524873
Z 750 R	750	2011	2014	NERO	SLIP-ON	ACIER INOX	524873
Z 750	750	2007	2014	LV ONE EVO	SLIP-ON	ACIER INOX	524852
Z 750 R	750	2011	2014	LV ONE EVO	SLIP-ON	ACIER INOX	524852
Z 900	900	2017	2019	NERO	SLIP-ON	ACIER INOX	524878
Z 900 A2	900	2018	2022	NERO	SLIP-ON	ACIER INOX	524878
Z 900	900	2017	2019	LV PRO	SLIP-ON	ACIER INOX	524942

Modèle	Cylindre	Année début	Année fin		Description	Matériau enveloppe	Réf.
Z 900	900	2017	2019	LV PRO TITANIUM	SLIP-ON	TITANE	524943
Z 900 A2	900	2018	2022	LV PRO	SLIP-ON	ACIER INOX	524942
Z 900 A2	900	2018	2022	LV PRO TITANIUM	SLIP-ON	TITANE	524943
Z 900	900	2017	2019	LV PRO CARBON FIBER	SLIP-ON	FIBRE DE CARBONE	524944
Z 900 A2	900	2018	2022	LV PRO CARBON FIBER	SLIP-ON	FIBRE DE CARBONE	524944
Z 900	900	2017	2019	LV-10 BLACK EDITION	SLIP-ON	ACIER INOX	525169
Z 900 A2	900	2018	2022	LV-10 BLACK EDITION	SLIP-ON	ACIER INOX	525169
Z 900	900	2017	2019	LV-10 CARBON FIBER	SLIP-ON	FIBRE DE CARBONE	525170
Z 900 A2	900	2018	2022	LV-10 CARBON FIBER	SLIP-ON	FIBRE DE CARBONE	525170
Z 900	900	2017	2019	LV-10 FULL BLACK	SLIP-ON	ACIER INOX	525171
Z 900 A2	900	2018	2022	LV-10 FULL BLACK	SLIP-ON	ACIER INOX	525171
Z 900	900	2017	2019	LV-10 TITANIUM	SLIP-ON	TITANE	525172
Z 900 A2	900	2018	2022	LV-10 TITANIUM	SLIP-ON	TITANE	525172
Z 900 RS/CAFE	900	2018	2022	LV-10 BLACK EDITION	SLIP-ON	ACIER INOX	525177
Z 900	900	2017	2019	LV-10	SLIP-ON	ACIER INOX	525168
Z 900 A2	900	2018	2022	LV-10	SLIP-ON	ACIER INOX	525168
Z 900 RS/CAFE	900	2018	2022	LV-10	SLIP-ON	ACIER INOX	525176
VERSYS 1000	1000	2019	2022	NERO	SLIP-ON	ACIER INOX	524890
Z 1000	1000	2017	2020	FACTORY S	2 SLIP-ON	ACIER INOX	524964
Z 1000 SX	1000	2017	2020	FACTORY S	2 SLIP-ON	ACIER INOX	524964
Z 1000	1000	2017	2020	FACTORY S CARBON FIBER	2 SLIP-ON	FIBRE DE CARBONE	524965
Z 1000 SX	1000	2017	2020	FACTORY S CARBON FIBER	2 SLIP-ON	FIBRE DE CARBONE	524965
VERSYS 1000	1000	2019	2022	LV ONE EVO	SLIP-ON	ACIER INOX	525020
NINJA 1000 SX/TOURER	1000	2020	2022	FACTORY S BLACK EDITION	SLIP-ON	ACIER INOX	525034
NINJA 1000 SX/TOURER	1000	2020	2022	FACTORY S TITANIUM	SLIP-ON	TITANE	525035
Z 1000	1000	2010	2016	LV-10 BLACK EDITION	2 SLIP-ON	ACIER INOX	525174
Z 1000	1000	2017	2020	LV-10 BLACK EDITION	2 SLIP-ON	ACIER INOX	525174
Z 1000 SX	1000	2010	2016	LV-10 BLACK EDITION	2 SLIP-ON	ACIER INOX	525174
Z 1000 SX	1000	2017	2020	LV-10 BLACK EDITION	2 SLIP-ON	ACIER INOX	525174
Z 1000	1000	2010	2016	LV-10 CARBON FIBER	2 SLIP-ON	FIBRE DE CARBONE	525175
Z 1000	1000	2017	2020	LV-10 CARBON FIBER	2 SLIP-ON	FIBRE DE CARBONE	525175
Z 1000 SX	1000	2010	2016	LV-10 CARBON FIBER	2 SLIP-ON	FIBRE DE CARBONE	525175
Z 1000 SX	1000	2017	2020	LV-10 CARBON FIBER	2 SLIP-ON	FIBRE DE CARBONE	525175
Z 1000	1000	2010	2016	LV-10	2 SLIP-ON	ACIER INOX	525173
Z 1000	1000	2017	2020	LV-10	2 SLIP-ON	ACIER INOX	525173
Z 1000 SX	1000	2010	2016	LV-10	2 SLIP-ON	ACIER INOX	525173
Z 1000 SX	1000	2017	2020	LV-10	2 SLIP-ON	ACIER INOX	525173
KTM							
DUKE 125	125	2017	2020	LV ONE EVO	SLIP-ON	ACIER INOX	524951
RC 125	125	2017	2020	LV ONE EVO	SLIP-ON	ACIER INOX	524951
DUKE 125	125	2017	2020	LV ONE EVO CARBON FIBER	SLIP-ON	FIBRE DE CARBONE	524952
RC 125	125	2017	2020	LV ONE EVO CARBON FIBER	SLIP-ON	FIBRE DE CARBONE	524952

Modèle	Cylindre	Année début	Année fin		Description	Matériau enveloppe	Réf.
DUKE 125	125	2021	2022	LV ONE EVO	SLIP-ON	ACIER INOX	525132
DUKE 125	125	2021	2022	LV ONE EVO BLACK EDITION	SLIP-ON	ACIER INOX	525133
DUKE 125	125	2021	2022	LV ONE EVO CARBON FIBER	SLIP-ON	FIBRE DE CARBONE	525134
RC 125	125	2022		LV ONE EVO	SLIP-ON	ACIER INOX	525145
RC 125	125	2022		LV ONE EVO BLACK EDITION	SLIP-ON	ACIER INOX	525146
RC 125	125	2022		LV ONE EVO CARBON FIBER	SLIP-ON	FIBRE DE CARBONE	525147
DUKE 125	125	2017	2020	GP ONE	SLIP-ON	ACIER INOX	525157
RC 125	125	2017	2020	GP ONE	SLIP-ON	ACIER INOX	525157
DUKE 390	390	2017	2020	LV ONE EVO	SLIP-ON	ACIER INOX	524951
RC 390	390	2017	2020	LV ONE EVO	SLIP-ON	ACIER INOX	524951
DUKE 390	390	2017	2020	LV ONE EVO CARBON FIBER	SLIP-ON	FIBRE DE CARBONE	524952
RC 390	390	2017	2020	LV ONE EVO CARBON FIBER	SLIP-ON	FIBRE DE CARBONE	524952
390 ADVENTURE	390	2020	2022	LV ONE EVO	SLIP-ON	ACIER INOX	525042
390 ADVENTURE	390	2020	2022	LV ONE EVO BLACK EDITION	SLIP-ON	ACIER INOX	525043
390 ADVENTURE	390	2020	2022	LV ONE EVO CARBON FIBER	SLIP-ON	FIBRE DE CARBONE	525044
DUKE 390	390	2021	2022	LV ONE EVO	SLIP-ON	ACIER INOX	525132
DUKE 390	390	2021	2022	LV ONE EVO BLACK EDITION	SLIP-ON	ACIER INOX	525133
DUKE 390	390	2021	2022	LV ONE EVO CARBON FIBER	SLIP-ON	FIBRE DE CARBONE	525134
DUKE 390	390	2017	2020	GP ONE	SLIP-ON	ACIER INOX	525157
RC 390	390	2017	2020	GP ONE	SLIP-ON	ACIER INOX	525157
LC4 640 SM/ENDURO	640	2003	2004	X3	SLIP-ON	ALUMINUM	524831
LC4 660 SM/ENDURO	660	2004	2005	X3	SLIP-ON	ALUMINUM	524831
690 DUKE LC4	690	2008	2011	UNDERBODY	SLIP-ON	ACIER INOX	524837
690 DUKE R LC4	690	2009	2011	UNDERBODY	SLIP-ON	ACIER INOX	524837
690 SMC R	690	2019	2022	NERO	SLIP-ON	ACIER INOX	524910
690 ENDURO R	690	2019	2022	NERO	SLIP-ON	ACIER INOX	524910
690 SMC R	690	2019	2022	NERO	FULL SYSTEM	ACIER INOX	524912
690 ENDURO R	690	2019	2022	NERO	FULL SYSTEM	ACIER INOX	524912
690 ENDURO	690	2008	2011	LV ONE EVO	SLIP-ON	ACIER INOX	524848
690 SMC	690	2008	2011	LV ONE EVO	SLIP-ON	ACIER INOX	524848
690 ENDURO R	690	2009	2016	LV ONE EVO	SLIP-ON	ACIER INOX	524848
690 SMC R	690	2012	2016	LV ONE EVO	SLIP-ON	ACIER INOX	524848
690 DUKE/R	690	2012	2015	LV ONE EVO	SLIP-ON	ACIER INOX	524861
690 SMC R	690	2019	2022	NERO	SLIP-ON	ACIER INOX	524911
690 ENDURO R	690	2019	2022	NERO	SLIP-ON	ACIER INOX	524911
690 SMC R	690	2019	2022	NERO	FULL SYSTEM	ACIER INOX	524913
690 ENDURO R	690	2019	2022	NERO	FULL SYSTEM	ACIER INOX	524913
690 DUKE/R	690	2016	2019	LV ONE EVO	SLIP-ON	ACIER INOX	525018
690 DUKE/R	690	2016	2019	LV ONE EVO CARBON FIBER	SLIP-ON	FIBRE DE CARBONE	525019
690 SMC R	690	2019	2022	LV ONE EVO	SLIP-ON	ACIER INOX	525075
690 ENDURO R	690	2019	2022	LV ONE EVO	SLIP-ON	ACIER INOX	525075
690 SMC R	690	2019	2022	LV ONE EVO	SLIP-ON	ACIER INOX	525076
690 ENDURO R	690	2019	2022	LV ONE EVO	SLIP-ON	ACIER INOX	525076
690 SMC R	690	2019	2022	LV ONE EVO	FULL SYSTEM	ACIER INOX	525077

Modèle	Cylindre	Année début	Année fin		Description	Matériau enveloppe	Réf.
690 ENDURO R	690	2019	2022	LV ONE EVO	FULL SYSTEM	ACIER INOX	525077
690 SMC R	690	2019	2022	LV ONE EVO	FULL SYSTEM	ACIER INOX	525078
690 ENDURO R	690	2019	2022	LV ONE EVO	FULL SYSTEM	ACIER INOX	525078
790 ADVENTURE/R	790	2019	2020	NERO	SLIP-ON	ACIER INOX	524899
790 DUKE / 790 DUKE L A2	790	2018	2020	LV ONE EVO	SLIP-ON	ACIER INOX	524989
790 DUKE / 790 DUKE L A2	790	2018	2020	LV ONE EVO CARBON FIBER	SLIP-ON	FIBRE DE CARBONE	524990
790 ADVENTURE/R	790	2019	2020	LV ONE EVO	SLIP-ON	ACIER INOX	525031
790 ADVENTURE/R	790	2019	2020	LV ONE EVO	SLIP-ON	ACIER INOX	525143
790 ADVENTURE/R	790	2019	2020	LV ONE EVO BLACK EDITION	SLIP-ON	ACIER INOX	525144
890 ADVENTURE/L (A2)/R/ RALLY	890	2021	2022	NERO	SLIP-ON	ACIER INOX	524899
890 DUKE/L (A2)/R	890	2020	2022	LV ONE EVO	SLIP-ON	ACIER INOX	524989
890 DUKE/L (A2)/R	890	2020	2022	LV ONE EVO CARBON FIBER	SLIP-ON	FIBRE DE CARBONE	524990
890 ADVENTURE/L (A2)/R/ RALLY	890	2021	2022	LV ONE EVO	SLIP-ON	ACIER INOX	525031
890 ADVENTURE/L (A2)/R/ RALLY	890	2021	2022	LV ONE EVO	SLIP-ON	ACIER INOX	525143
890 ADVENTURE/L (A2)/R/ RALLY	890	2021	2022	LV ONE EVO BLACK EDITION	SLIP-ON	ACIER INOX	525144
950 SM SUPERMOTO	950	2005	2008	LV ONE EVO	2 SLIP-ON	ACIER INOX	524853
950 LC8 ADVENTURE S	950	2003	2005	LV ONE EVO	2 SLIP-ON	ACIER INOX	524858
990 SM SUPERMOTO	990	2008	2010	LV ONE EVO	2 SLIP-ON	ACIER INOX	524853
990 SM R SUPERMOTO R	990	2009	2012	LV ONE EVO	2 SLIP-ON	ACIER INOX	524853
990 LC8 ADVENTURE	990	2006	2012	LV ONE EVO	2 SLIP-ON	ACIER INOX	524858
990 LC8 ADVENTURE R	990	2009	2012	LV ONE EVO	2 SLIP-ON	ACIER INOX	524858
1090 ADVENTURE/R	1050	2017	2019	NERO	SLIP-ON	ACIER INOX	524882
1090 ADVENTURE/R	1050	2017	2019	LV ONE EVO	SLIP-ON	ACIER INOX	524956
1090 ADVENTURE/R	1050	2017	2019	LV ONE EVO TITANIUM	SLIP-ON	TITANE	524957
1050 ADVENTURE	1050	2015	2016	LV-12 BLACK EDITION	SLIP-ON	ACIER INOX	525208
1090 ADVENTURE/R	1050	2017	2019	LV-12 BLACK EDITION	SLIP-ON	ACIER INOX	525208
1050 ADVENTURE	1050	2015	2016	LV-12 TITANIUM	SLIP-ON	TITANE	525209
1090 ADVENTURE/R	1050	2017	2019	LV-12 TITANIUM	SLIP-ON	TITANE	525209
1050 ADVENTURE	1050	2015	2016	LV-12	SLIP-ON	ACIER INOX	525207
1090 ADVENTURE/R	1050	2017	2019	LV-12	SLIP-ON	ACIER INOX	525207
1190 ADVENTURE/R	1190	2013	2016	LV-12 BLACK EDITION	SLIP-ON	ACIER INOX	525208
1190 ADVENTURE/R	1190	2013	2016	LV-12 TITANIUM	SLIP-ON	TITANE	525209
1190 ADVENTURE/R	1190	2013	2016	LV-12	SLIP-ON	ACIER INOX	525207
1290 SUPER ADVENTURE R/S/T	1290	2017	2020	NERO	SLIP-ON	ACIER INOX	524882
1290 SUPER ADVENTURE R/S/T	1290	2017	2020	LV ONE EVO	SLIP-ON	ACIER INOX	524956
1290 SUPER ADVENTURE R/S/T	1290	2017	2020	LV ONE EVO TITANIUM	SLIP-ON	TITANE	524957
1290 SUPER ADVENTURE	1290	2015	2016	LV-12 BLACK EDITION	SLIP-ON	ACIER INOX	525208
1290 SUPER ADVENTURE R/S/T	1290	2017	2020	LV-12 BLACK EDITION	SLIP-ON	ACIER INOX	525208
1290 SUPER ADVENTURE	1290	2015	2020	LV-12 TITANIUM	SLIP-ON	TITANE	525209
1290 SUPER ADVENTURE R/S/T	1290	2017	2020	LV-12 TITANIUM	SLIP-ON	TITANE	525209
1290 SUPER ADVENTURE	1290	2015	2016	LV-12	SLIP-ON	ACIER INOX	525207
1290 SUPER ADVENTURE R/S/T	1290	2017	2020	LV-12	SLIP-ON	ACIER INOX	525207

Modèle	Cylindre	Année début	Année fin		Description	Matériau enveloppe	Réf.
KYMCO							
DINK STREET 125i	125	2009	2016	NERO	FULL SYSTEM	ACIER INOX	498878
DOWNTOWN 125i	125	2009	2016	NERO	FULL SYSTEM	ACIER INOX	498878
SUPERDINK 125i	125	2009	2016	NERO	FULL SYSTEM	ACIER INOX	498878
XCITING 400i	400	2012	2016	NERO	SLIP-ON	ACIER INOX	524874
MOTO GUZZI							
V85 TT	850	2019	2022	LV ONE EVO	SLIP-ON	ACIER INOX	525045
V85 TT	850	2019	2022	LV ONE EVO BLACK EDITION	SLIP-ON	ACIER INOX	525046
MOTO MORINI							
X-CAPE 650/A2	650	2021	2022	LV PRO	SLIP-ON	ACIER INOX	525141
X-CAPE 650/A2	650	2021	2022	LV PRO CARBON FIBER	SLIP-ON	FIBRE DE CARBONE	525142
PEUGEOT							
METROPOLIS 400i	400	2013	2016	NERO	SLIP-ON	ACIER INOX	498874
PIAGGIO							
MP3 400/LT/RST	400	2007	2012	NERO	SLIP-ON	ACIER INOX	498877
MP3 400/LT/RST	400	2007	2012	LV ONE EVO	SLIP-ON	ACIER INOX	498876
MP3 500/BUSINESS/LT/SPORT	500	2011	2016	NERO	SLIP-ON	ACIER INOX	498877
MP3 500/BUSINESS/LT/SPORT	500	2011	2016	LV ONE EVO	SLIP-ON	ACIER INOX	498876
SUZUKI							
DR-Z 400 S/SM	400	2001	2008	X3	SLIP-ON	ALUMINUM	524829
LTZ 400	400	2003	2008	X3	SLIP-ON	ALUMINUM	524830
GSX-R 600	600	2006	2007	GP STYLE	SLIP-ON	ACIER INOX	524834
DR 650 SE	650	1996	2015	X3	SLIP-ON	ALUMINUM	524827
SV 650	650	2016	2022	NERO	SLIP-ON	ACIER INOX	524877
SV 650 X	650	2018	2020	NERO	SLIP-ON	ACIER INOX	524877
GSF 650 BANDIT/S	650	2007	2015	LV ONE EVO	SLIP-ON	ACIER INOX	524854
GSX-F 650	650	2008	2015	LV ONE EVO	SLIP-ON	ACIER INOX	524854
SV 650	650	2016	2022	LV ONE EVO	SLIP-ON	ACIER INOX	524938
SV 650 X	650	2018	2020	LV ONE EVO	SLIP-ON	ACIER INOX	524938
V-STROM 650/XT	650	2017	2022	LV ONE EVO	SLIP-ON	ACIER INOX	525096
V-STROM 650/XT	650	2017	2022	LV ONE EVO	SLIP-ON	ACIER INOX	525097
V-STROM 650/XT	650	2017	2022	LV ONE EVO BLACK EDITION	SLIP-ON	ACIER INOX	525098
V-STROM 650/XT	650	2017	2022	LV ONE EVO BLACK EDITION	SLIP-ON	ACIER INOX	525099
SV 650	650	2016	2022	GP DUALS	SLIP-ON	ACIER INOX	525154
SV 650 X	650	2018	2020	GP DUALS	SLIP-ON	ACIER INOX	525154
GSX-R 750	750	2006	2007	GP STYLE	SLIP-ON	ACIER INOX	524834
GSX-S 750/Z ABS	750	2017	2020	NERO	SLIP-ON	ACIER INOX	524879
GSX-S 750/Z ABS A2	750	2019	2020	NERO	SLIP-ON	ACIER INOX	524879
GSX-S 750/Z ABS	750	2017	2020	LV ONE EVO	SLIP-ON	ACIER INOX	524945
GSX-S 750/Z ABS A2	750	2019	2020	LV ONE EVO	SLIP-ON	ACIER INOX	524945
GSX-S 750/Z ABS	750	2017	2020	LV ONE EVO CARBON FIBER	SLIP-ON	FIBRE DE CARBONE	524946
GSX-S 750/Z ABS A2	750	2019	2020	LV ONE EVO CARBON FIBER	SLIP-ON	FIBRE DE CARBONE	524946
V-STROM 1000 ABS/XT	1000	2017	2020	NERO	SLIP-ON	ACIER INOX	524884
GSX-S 1000	1000	2015	2016	LV-10 BLACK EDITION	SLIP-ON	ACIER INOX	525183
GSX-S 1000 F	1000	2015	2016	LV-10 BLACK EDITION	SLIP-ON	ACIER INOX	525183

MOTEUR

CYCLE

PNEUMATIQUE

ATELIER

ACCESSOIRES

ÉLECTRICITÉ

FILTRATION

FREINAGE

TRANSMISSION

Modèle	Cylindre	Année début	Année fin		Description	Matériau enveloppe	Réf.
GSX-S 1000	1000	2017	2020	LV-10 BLACK EDITION	SLIP-ON	ACIER INOX	525183
GSX-S 1000 F	1000	2017	2020	LV-10 BLACK EDITION	SLIP-ON	ACIER INOX	525183
GSX-S 950	1000	2021	2022	LV-10 BLACK EDITION	SLIP-ON	ACIER INOX	525192
GSX-S 1000	1000	2021	2022	LV-10 BLACK EDITION	SLIP-ON	ACIER INOX	525192
GSX-S 1000 GT	1000	2021	2022	LV-10 BLACK EDITION	SLIP-ON	ACIER INOX	525192
GSX-S 950	1000	2021	2022	LV-10 CARBON FIBER	SLIP-ON	FIBRE DE CARBONE	525193
GSX-S 1000	1000	2021	2022	LV-10 CARBON FIBER	SLIP-ON	FIBRE DE CARBONE	525193
GSX-S 1000 GT	1000	2021	2022	LV-10 CARBON FIBER	SLIP-ON	FIBRE DE CARBONE	525193
V-STROM 1000	1000	2014	2016	LV-12 BLACK EDITION	SLIP-ON	ACIER INOX	525220
V-STROM 1000 ABS/XT	1000	2017	2020	LV-12 BLACK EDITION	SLIP-ON	ACIER INOX	525220
V-STROM 1000	1000	2014	2016	LV-12 TITANIUM	SLIP-ON	TITANE	525221
V-STROM 1000 ABS/XT	1000	2017	2020	LV-12 TITANIUM	SLIP-ON	TITANE	525221
GSX-S 1000	1000	2015	2016	LV-10	SLIP-ON	ACIER INOX	525182
GSX-S 1000 F	1000	2015	2016	LV-10	SLIP-ON	ACIER INOX	525182
GSX-S 1000	1000	2017	2020	LV-10	SLIP-ON	ACIER INOX	525182
GSX-S 1000 F	1000	2017	2020	LV-10	SLIP-ON	ACIER INOX	525182
GSX-S 950	1000	2021	2022	LV-10	SLIP-ON	ACIER INOX	525191
GSX-S 1000	1000	2021	2022	LV-10	SLIP-ON	ACIER INOX	525191
GSX-S 1000 GT	1000	2021	2022	LV-10	SLIP-ON	ACIER INOX	525191
V-STROM 1000	1000	2014	2016	LV-12	SLIP-ON	ACIER INOX	525219
V-STROM 1000 ABS/XT	1000	2017	2020	LV-12	SLIP-ON	ACIER INOX	525219
V-STROM 1050 ABS/XT	1050	2020	2022	LV-12 BLACK EDITION	SLIP-ON	ACIER INOX	525217
V-STROM 1050 ABS/XT	1050	2020	2022	LV-12 TITANIUM	SLIP-ON	TITANE	525218
V-STROM 1050 ABS/XT	1050	2020	2022	LV-12	SLIP-ON	ACIER INOX	525216
BANDIT 1250	1250	2007	2016	LV ONE EVO	SLIP-ON	ACIER INOX	524855
GSX 1250 FA	1250	2010	2016	LV ONE EVO	SLIP-ON	ACIER INOX	524855
TRIUMPH							
TIGER SPORT 660	660	2022		LV ONE EVO	FULL SYSTEM	ACIER INOX	525115
TRIDENT 660	660	2021	2022	LV ONE EVO	FULL SYSTEM	ACIER INOX	525115
TIGER SPORT 660	660	2022		LV ONE EVO	FULL SYSTEM	ACIER INOX	525116
TRIDENT 660	660	2021	2022	LV ONE EVO	FULL SYSTEM	ACIER INOX	525116
TIGER SPORT 660	660	2022		LV ONE EVO BLACK EDITION	FULL SYSTEM	ACIER INOX	525117
TRIDENT 660	660	2021	2022	LV ONE EVO BLACK EDITION	FULL SYSTEM	ACIER INOX	525117
TIGER SPORT 660	660	2022		LV ONE EVO BLACK EDITION	FULL SYSTEM	ACIER INOX	525118
TRIDENT 660	660	2021	2022	LV ONE EVO BLACK EDITION	FULL SYSTEM	ACIER INOX	525118
TIGER SPORT 660	660	2022		LV ONE EVO CARBON FIBER	FULL SYSTEM	FIBRE DE CARBONE	525119
TRIDENT 660	660	2021	2022	LV ONE EVO CARBON FIBER	FULL SYSTEM	FIBRE DE CARBONE	525119
TIGER SPORT 660	660	2022		LV ONE EVO CARBON FIBER	FULL SYSTEM	FIBRE DE CARBONE	525120
TRIDENT 660	660	2021	2022	LV ONE EVO CARBON FIBER	FULL SYSTEM	FIBRE DE CARBONE	525120
TIGER 800 XC/XCA/XCX/XR/XRX	800	2011	2016	NERO	SLIP-ON	ACIER INOX	524872
TIGER 900 GT/RALLY/PRO	900	2020	2022	LV ONE EVO	SLIP-ON	ACIER INOX	525055
TIGER 900 GT/RALLY/PRO	900	2020	2022	LV ONE EVO BLACK EDITION	SLIP-ON	ACIER INOX	525056
SPEED TRIPLE 1050 RS/S	1050	2018	2019	FACTORY S	SLIP-ON	ACIER INOX	525004
SPEED TRIPLE 1050 RS/S	1050	2018	2019	FACTORY S TITANIUM	SLIP-ON	TITANE	525005

Modèle	Cylindre	Année début	Année fin		Description	Matériau enveloppe	Réf.
SPEED TRIPLE 1050 RS/S	1050	2018	2019	FACTORY S CARBON FIBER	SLIP-ON	FIBRE DE CARBONE	525006
TIGER 1200 GT/RALLY	1200	2022		NERO	SLIP-ON	ACIER INOX	524930
TIGER 1200 GT/RALLY	1200	2022		LV ONE EVO	SLIP-ON	ACIER INOX	525148
SPEED TRIPLE 1200 RR/RS	1200	2021	2022	LV-10 BLACK EDITION	2 SLIP-ON	ACIER INOX	525195
SPEED TRIPLE 1200 RR/RS	1200	2021	2022	LV-10	2 SLIP-ON	ACIER INOX	525194
STREET TRIPLE 765 S/ SA2/R/R LRH/RS	660/765	2017	2019	LV PRO	SLIP-ON	ACIER INOX	525008
STREET TRIPLE 765 S/ SA2/R/R LRH/RS	660/765	2020	2022	LV PRO	SLIP-ON	ACIER INOX	525008
STREET TRIPLE 765 S/ SA2/R/R LRH/RS	660/765	2017	2019	LV PRO CARBON FIBER	SLIP-ON	FIBRE DE CARBONE	525009
STREET TRIPLE 765 S/ SA2/R/R LRH/RS	660/765	2020	2022	LV PRO CARBON FIBER	SLIP-ON	FIBRE DE CARBONE	525009
VESPA							
PRIMAVERA 125 iGet ABS	125	2019	2020	NERO	FULL SYSTEM	ACIER INOX	524902
SPRINT 125 iGet ABS	125	2019	2020	NERO	FULL SYSTEM	ACIER INOX	524902
GTS 125 i.e.	125	2017	2020	NERO	FULL SYSTEM	ACIER INOX	524907
GTS 125 i.e./SUPER	125	2021	2022	NERO	SLIP-ON	ACIER INOX	524924
PRIMAVERA 125 3V	125	2021	2022	NERO	FULL SYSTEM	ACIER INOX	524928
SPRINT 125 3V	125	2021	2022	NERO	FULL SYSTEM	ACIER INOX	524928
PRIMAVERA 125 iGet ABS	125	2019	2020	NERO	FULL SYSTEM	ACIER INOX	524903
SPRINT 125 iGet ABS	125	2019	2020	NERO	FULL SYSTEM	ACIER INOX	524903
GTS 125 i.e.	125	2017	2020	NERO	FULL SYSTEM	ACIER INOX	524906
GTS 125 i.e./SUPER	125	2021	2022	NERO	SLIP-ON	ACIER INOX	524925
PRIMAVERA 125 3V	125	2021	2022	NERO	FULL SYSTEM	ACIER INOX	524929
SPRINT 125 3V	125	2021	2022	NERO	FULL SYSTEM	ACIER INOX	524929
GTS 125 i.e.	125	2017	2020	LV ONE EVO	FULL SYSTEM	ACIER INOX	525066
GTS 125 i.e.	125	2017	2020	LV ONE EVO	FULL SYSTEM	ACIER INOX	525065
GTS 125 i.e./SUPER	125	2021	2022	LV ONE EVO	SLIP-ON	ACIER INOX	525110
GTS 125 i.e./SUPER	125	2021	2022	LV ONE EVO	SLIP-ON	ACIER INOX	525111
PRIMAVERA 125 3V	125	2021	2022	LV ONE EVO	FULL SYSTEM	ACIER INOX	525135
SPRINT 125 3V	125	2021	2022	LV ONE EVO	FULL SYSTEM	ACIER INOX	525135
PRIMAVERA 125 3V	125	2021	2022	LV ONE EVO	FULL SYSTEM	ACIER INOX	525136
SPRINT 125 3V	125	2021	2022	LV ONE EVO	FULL SYSTEM	ACIER INOX	525136
GTS 150 i.e.	150	2017	2020	NERO	FULL SYSTEM	ACIER INOX	524907
GTS 150 i.e.	150	2017	2020	NERO	FULL SYSTEM	ACIER INOX	524906
GTS 150 i.e.	150	2017	2020	LV ONE EVO	FULL SYSTEM	ACIER INOX	525066
GTS 150 i.e.	150	2017	2020	LV ONE EVO	FULL SYSTEM	ACIER INOX	525065
GTS 300 HPE/SUPER/SEI GIORNI	300	2019	2020	NERO	SLIP-ON	ACIER INOX	524892
GTS 300 HPE/RACING SIXTIES/SUPER/SEI GIORNI/SPORT/TECH/TOURING	300	2021	2022	NERO	FULL SYSTEM	ACIER INOX	524908
GTS 300 HPE/SUPER/SEI GIORNI	300	2019	2020	NERO	SLIP-ON	ACIER INOX	524893
GTS 300 HPE/RACING SIXTIES/SUPER/SEI GIORNI/SPORT/TECH/TOURING	300	2021	2022	NERO	FULL SYSTEM	ACIER INOX	524909
GTS 300 HPE/SUPER/SEI GIORNI	300	2019	2020	LV ONE EVO	SLIP-ON	ACIER INOX	525025
GTS 300 HPE/SUPER/SEI GIORNI	300	2019	2020	LV ONE EVO	SLIP-ON	ACIER INOX	525026

Modèle	Cylindre	Année début	Année fin		Description	Matériau enveloppe	Réf.
GTS 300 HPE/RACING SIXTIES/SUPER/SEI GIORNI/SPORT/TECH/TOURING	300	2021	2022	LV ONE EVO	FULL SYSTEM	ACIER INOX	525073
GTS 300 HPE/RACING SIXTIES/SUPER/SEI GIORNI/SPORT/TECH/TOURING	300	2021	2022	LV ONE EVO	FULL SYSTEM	ACIER INOX	525074
GTS 125 SUPER	125	2009	2015	LV ONE EVO	SLIP-ON	ACIER INOX	498880
GTS 250	250	2005	2013	LV ONE EVO	SLIP-ON	ACIER INOX	498880
GTV 250	250	2006	2013	LV ONE EVO	SLIP-ON	ACIER INOX	498880
GTV 250 NAVY	250	2008	2008	LV ONE EVO	SLIP-ON	ACIER INOX	498880
GTS 300 SUPER	300	2008	2015	LV ONE EVO	SLIP-ON	ACIER INOX	498880
GTS 300 SUPERSPORT	300	2010	2015	LV ONE EVO	SLIP-ON	ACIER INOX	498880
GTV 300 VIA MONTENAPOLEONE	300	2010	2013	LV ONE EVO	SLIP-ON	ACIER INOX	498880
YAMAHA							
WR 125 R/X	125	2009	2016	LV ONE	SLIP-ON	ACIER INOX	524865
MT-125	125	2014	2016	LV ONE	FULL SYSTEM	ACIER INOX	524871
YZF-R 125	125	2014	2016	LV ONE	FULL SYSTEM	ACIER INOX	524871
X-MAX 125/IRON MAX	125	2018	2020	NERO	FULL SYSTEM	ACIER INOX	517320
X-MAX 125/TECH MAX	125	2021	2022	NERO	FULL SYSTEM	ACIER INOX	519550
X-MAX 125/IRON MAX	125	2018	2020	NERO	FULL SYSTEM	ACIER INOX	524894
X-MAX 125/TECH MAX	125	2021	2022	NERO	FULL SYSTEM	ACIER INOX	524921
MT-125	125	2017	2019	LV ONE EVO	FULL SYSTEM	ACIER INOX	508658
YZF-R 125	125	2017	2018	LV ONE EVO	FULL SYSTEM	ACIER INOX	508658
MT-125	125	2017	2019	LV ONE EVO	FULL SYSTEM	ACIER INOX	524995
YZF-R 125	125	2017	2018	LV ONE EVO	FULL SYSTEM	ACIER INOX	524995
MT-125	125	2017	2019	LV ONE EVO CARBON FIBER	FULL SYSTEM	FIBRE DE CARBONE	524996
YZF-R 125	125	2017	2018	LV ONE EVO CARBON FIBER	FULL SYSTEM	FIBRE DE CARBONE	524996
MT-125	125	2017	2019	LV ONE EVO CARBON FIBER	FULL SYSTEM	FIBRE DE CARBONE	524997
YZF-R 125	125	2017	2018	LV ONE EVO CARBON FIBER	FULL SYSTEM	FIBRE DE CARBONE	524997
MT-125	125	2020	2020	LV ONE EVO	FULL SYSTEM	ACIER INOX	525036
YZF-R 125	125	2019	2020	LV ONE EVO	FULL SYSTEM	ACIER INOX	525036
MT-125	125	2020	2020	LV ONE EVO	FULL SYSTEM	ACIER INOX	525037
YZF-R 125	125	2019	2020	LV ONE EVO	FULL SYSTEM	ACIER INOX	525037
MT-125	125	2020	2020	LV ONE EVO BLACK EDITION	FULL SYSTEM	ACIER INOX	525038
YZF-R 125	125	2019	2020	LV ONE EVO BLACK EDITION	FULL SYSTEM	ACIER INOX	525038
MT-125	125	2020	2020	LV ONE EVO BLACK EDITION	FULL SYSTEM	ACIER INOX	525039
YZF-R 125	125	2019	2020	LV ONE EVO BLACK EDITION	FULL SYSTEM	ACIER INOX	525039
MT-125	125	2020	2020	LV ONE EVO CARBON FIBER	FULL SYSTEM	FIBRE DE CARBONE	525040
YZF-R 125	125	2019	2020	LV ONE EVO CARBON FIBER	FULL SYSTEM	FIBRE DE CARBONE	525040
MT-125	125	2020	2020	LV ONE EVO CARBON FIBER	FULL SYSTEM	FIBRE DE CARBONE	525041
YZF-R 125	125	2019	2020	LV ONE EVO CARBON FIBER	FULL SYSTEM	FIBRE DE CARBONE	525041
MT-125	125	2021	2022	LV ONE EVO	FULL SYSTEM	ACIER INOX	525079
XSR 125	125	2021	2022	LV ONE EVO	FULL SYSTEM	ACIER INOX	525079
YZF-R 125	125	2021	2022	LV ONE EVO	FULL SYSTEM	ACIER INOX	525079
MT-125	125	2021	2022	LV ONE EVO	FULL SYSTEM	ACIER INOX	525080

Modèle	Cylindre	Année début	Année fin		Description	Matériau enveloppe	Réf.
XSR 125	125	2021	2022	LV ONE EVO	FULL SYSTEM	ACIER INOX	525080
YZF-R 125	125	2021	2022	LV ONE EVO	FULL SYSTEM	ACIER INOX	525080
MT-125	125	2021	2022	LV ONE EVO BLACK EDITION	FULL SYSTEM	ACIER INOX	525081
XSR 125	125	2021	2022	LV ONE EVO BLACK EDITION	FULL SYSTEM	ACIER INOX	525081
YZF-R 125	125	2021	2022	LV ONE EVO BLACK EDITION	FULL SYSTEM	ACIER INOX	525081
MT-125	125	2021	2022	LV ONE EVO BLACK EDITION	FULL SYSTEM	ACIER INOX	525082
XSR 125	125	2021	2022	LV ONE EVO BLACK EDITION	FULL SYSTEM	ACIER INOX	525082
YZF-R 125	125	2021	2022	LV ONE EVO BLACK EDITION	FULL SYSTEM	ACIER INOX	525082
MT-125	125	2021	2022	LV ONE EVO CARBON FIBER	FULL SYSTEM	FIBRE DE CARBONE	525083
XSR 125	125	2021	2022	LV ONE EVO CARBON FIBER	FULL SYSTEM	FIBRE DE CARBONE	525083
YZF-R 125	125	2021	2022	LV ONE EVO CARBON FIBER	FULL SYSTEM	FIBRE DE CARBONE	525083
MT-125	125	2021	2022	LV ONE EVO CARBON FIBER	FULL SYSTEM	FIBRE DE CARBONE	525084
XSR 125	125	2021	2022	LV ONE EVO CARBON FIBER	FULL SYSTEM	FIBRE DE CARBONE	525084
YZF-R 125	125	2021	2022	LV ONE EVO CARBON FIBER	FULL SYSTEM	FIBRE DE CARBONE	525084
X-MAX 125/TECH MAX	125	2021	2022	LV ONE EVO	FULL SYSTEM	ACIER INOX	525100
X-MAX 125/TECH MAX	125	2021	2022	LV ONE EVO	FULL SYSTEM	ACIER INOX	525101
MT-25	250	2015	2018	LV ONE EVO	FULL SYSTEM	ACIER INOX	524934
YZF-R25	250	2014	2018	LV ONE EVO	FULL SYSTEM	ACIER INOX	524934
MT-25	250	2015	2018	LV ONE EVO CARBON FIBER	FULL SYSTEM	FIBRE DE CARBONE	524935
YZF-R25	250	2014	2018	LV ONE EVO CARBON FIBER	FULL SYSTEM	FIBRE DE CARBONE	524935
X-MAX 300/IRON MAX	300	2017	2020	NERO	SLIP-ON	ACIER INOX	524887
X-MAX 300/TECH MAX	300	2021	2022	NERO	SLIP-ON	ACIER INOX	524919
X-MAX 300/IRON MAX	300	2017	2020	NERO	SLIP-ON	ACIER INOX	524888
X-MAX 300/TECH MAX	300	2021	2022	NERO	SLIP-ON	ACIER INOX	524920
MT-03	300	2016	2017	LV ONE EVO	FULL SYSTEM	ACIER INOX	524934
MT-03	300	2018	2019	LV ONE EVO	FULL SYSTEM	ACIER INOX	524934
MT-03	300	2020	2020	LV ONE EVO	FULL SYSTEM	ACIER INOX	524934
YZF-R3	300	2015	2017	LV ONE EVO	FULL SYSTEM	ACIER INOX	524934
YZF-R3	300	2018	2018	LV ONE EVO	FULL SYSTEM	ACIER INOX	524934
YZF-R3	300	2019	2020	LV ONE EVO	FULL SYSTEM	ACIER INOX	524934
MT-03	300	2016	2017	LV ONE EVO CARBON FIBER	FULL SYSTEM	FIBRE DE CARBONE	524935
MT-03	300	2018	2019	LV ONE EVO CARBON FIBER	FULL SYSTEM	FIBRE DE CARBONE	524935
MT-03	300	2020	2020	LV ONE EVO CARBON FIBER	FULL SYSTEM	FIBRE DE CARBONE	524935
YZF-R3	300	2015	2017	LV ONE EVO CARBON FIBER	FULL SYSTEM	FIBRE DE CARBONE	524935
YZF-R3	300	2018	2018	LV ONE EVO CARBON FIBER	FULL SYSTEM	FIBRE DE CARBONE	524935
YZF-R3	300	2019	2020	LV ONE EVO CARBON FIBER	FULL SYSTEM	FIBRE DE CARBONE	524935
X-MAX 300/IRON MAX	300	2017	2020	LV ONE EVO	SLIP-ON	ACIER INOX	524966
X-MAX 300/IRON MAX	300	2017	2020	LV ONE EVO	SLIP-ON	ACIER INOX	524967
MT-03	300	2018	2019	LV PRO	SLIP-ON	ACIER INOX	524991
MT-03	300	2020	2020	LV PRO	SLIP-ON	ACIER INOX	524991
YZF-R3	300	2018	2018	LV PRO	SLIP-ON	ACIER INOX	524991

Modèle	Cylindre	Année début	Année fin		Description	Matériau enveloppe	Réf.
YZF-R3	300	2019	2020	LV PRO	SLIP-ON	ACIER INOX	524991
MT-03	300	2018	2019	LV PRO CARBON FIBER	SLIP-ON	FIBRE DE CARBONE	524992
MT-03	300	2020	2020	LV PRO CARBON FIBER	SLIP-ON	FIBRE DE CARBONE	524992
YZF-R3	300	2018	2018	LV PRO CARBON FIBER	SLIP-ON	FIBRE DE CARBONE	524992
YZF-R3	300	2019	2020	LV PRO CARBON FIBER	SLIP-ON	FIBRE DE CARBONE	524992
X-MAX 300/TECH MAX	300	2021	2022	LV ONE EVO	SLIP-ON	ACIER INOX	525094
X-MAX 300/TECH MAX	300	2021	2022	LV ONE EVO	SLIP-ON	ACIER INOX	525095
X-MAX 400	400	2013	2016	NERO	SLIP-ON	ACIER INOX	498872
T-MAX 500	500	2008	2011	NERO	FULL SYSTEM	ACIER INOX	524875
T-MAX 530	530	2012	2016	NERO	FULL SYSTEM	ACIER INOX	520963
T-MAX 530 ABS/DX/SX	530	2017	2019	NERO	FULL SYSTEM	ACIER INOX	520964
T-MAX 530	530	2012	2016	LV ONE EVO	FULL SYSTEM	ACIER INOX	524860
T-MAX 530 ABS/DX/SX	530	2017	2019	NERO	FULL SYSTEM	ACIER INOX	524881
T-MAX 560/TECH MAX	560	2020	2022	LV-12	FULL SYSTEM	ACIER INOX	525222
T-MAX 560/TECH MAX	560	2020	2022	LV-12 BLACK EDITION	FULL SYSTEM	ACIER INOX	520967
T-MAX 560/TECH MAX	560	2020	2022	LV-12 BLACK EDITION	FULL SYSTEM - BLACK PAINTED HEADER PIPES	ACIER INOX	525223
T-MAX 560/TECH MAX	560	2020	2022	LV-12 BLACK EDITION	FULL SYSTEM	ACIER INOX	520968
T-MAX 560/TECH MAX	560	2020	2022	LV-12 TITANIUM	FULL SYSTEM	TITANE	525224
XJ6/DIVERSION/FZ6R	600	2009	2015	UNDERBODY	FULL SYSTEM	ACIER INOX	524835
TT 600 R	600	1998	2005	X3	SLIP-ON	ALUMINIUM	524833
TTE 600	600	1994	2002	X3	SLIP-ON	ALUMINIUM	524833
FZ6 S2/ABS	600	2007	2011	LV ONE	2 SLIP-ON	ACIER INOX	524842
FZ6 FAZER S2/ABS	600	2007	2011	LV ONE	2 SLIP-ON	ACIER INOX	524842
FZ6/FZ6 NS/FAZER	600	2004	2006	LV ONE	2 SLIP-ON	ACIER INOX	524856
XT 660 R/X	660	2004	2016	X3	2 SLIP-ON	ALUMINIUM	524832
MT-07/FZ-07	700	2014	2016	UNDERBODY	FULL SYSTEM	ACIER INOX	524870
MT-07/FZ-07	700	2017	2020	UNDERBODY	FULL SYSTEM	ACIER INOX	524936
TRACER 700	700	2016	2020	UNDERBODY	FULL SYSTEM	ACIER INOX	524936
TRACER 700 GT	700	2019	2020	UNDERBODY	FULL SYSTEM	ACIER INOX	524936
XSR 700	700	2016	2020	UNDERBODY	FULL SYSTEM	ACIER INOX	524936
MT-07/FZ-07	700	2017	2020	UNDERBODY	FULL SYSTEM	ACIER INOX	524937
TRACER 700	700	2016	2020	UNDERBODY	FULL SYSTEM	ACIER INOX	524937
TRACER 700 GT	700	2019	2020	UNDERBODY	FULL SYSTEM	ACIER INOX	524937
XSR 700	700	2016	2020	UNDERBODY	FULL SYSTEM	ACIER INOX	524937
MT-07/FZ-07	700	2017	2020	LV ONE EVO	FULL SYSTEM	ACIER INOX	524983
TRACER 700	700	2016	2020	LV ONE EVO	FULL SYSTEM	ACIER INOX	524983
TRACER 700 GT	700	2019	2020	LV ONE EVO	FULL SYSTEM	ACIER INOX	524983
XSR 700	700	2016	2020	LV ONE EVO	FULL SYSTEM	ACIER INOX	524983
MT-07/FZ-07	700	2017	2020	LV ONE EVO BLACK EDITION	FULL SYSTEM	ACIER INOX	524984
TRACER 700	700	2016	2020	LV ONE EVO BLACK EDITION	FULL SYSTEM	ACIER INOX	524984
TRACER 700 GT	700	2019	2020	LV ONE EVO BLACK EDITION	FULL SYSTEM	ACIER INOX	524984
XSR 700	700	2016	2020	LV ONE EVO BLACK EDITION	FULL SYSTEM	ACIER INOX	524984
MT-07/FZ-07	700	2017	2020	LV ONE EVO	FULL SYSTEM	ACIER INOX	524985
TRACER 700	700	2016	2020	LV ONE EVO	FULL SYSTEM	ACIER INOX	524985

Modèle	Cylindre	Année début	Année fin		Description	Matériau enveloppe	Réf.
TRACER 700 GT	700	2019	2020	LV ONE EVO	FULL SYSTEM	ACIER INOX	524985
XSR 700	700	2016	2020	LV ONE EVO	FULL SYSTEM	ACIER INOX	524985
MT-07/FZ-07	700	2017	2020	LV ONE EVO BLACK EDITION	FULL SYSTEM	ACIER INOX	524986
TRACER 700	700	2016	2020	LV ONE EVO BLACK EDITION	FULL SYSTEM	ACIER INOX	524986
TRACER 700 GT	700	2019	2020	LV ONE EVO BLACK EDITION	FULL SYSTEM	ACIER INOX	524986
XSR 700	700	2016	2020	LV ONE EVO BLACK EDITION	FULL SYSTEM	ACIER INOX	524986
MT-07/FZ-07	700	2017	2020	LV ONE EVO CARBON FIBER	FULL SYSTEM	FIBRE DE CARBONE	524987
TRACER 700	700	2016	2020	LV ONE EVO CARBON FIBER	FULL SYSTEM	FIBRE DE CARBONE	524987
TRACER 700 GT	700	2019	2020	LV ONE EVO CARBON FIBER	FULL SYSTEM	FIBRE DE CARBONE	524987
XSR 700	700	2016	2020	LV ONE EVO CARBON FIBER	FULL SYSTEM	FIBRE DE CARBONE	524987
MT-07/FZ-07	700	2017	2020	LV ONE EVO CARBON FIBER	FULL SYSTEM	FIBRE DE CARBONE	524988
TRACER 700	700	2016	2020	LV ONE EVO CARBON FIBER	FULL SYSTEM	FIBRE DE CARBONE	524988
TRACER 700 GT	700	2019	2020	LV ONE EVO CARBON FIBER	FULL SYSTEM	FIBRE DE CARBONE	524988
XSR 700	700	2016	2020	LV ONE EVO CARBON FIBER	FULL SYSTEM	FIBRE DE CARBONE	524988
XSR 700	700	2016	2020	GP DUALS	FULL SYSTEM	ACIER INOX	525155
XSR 700/XTRIBUTE	700	2021	2022	GP DUALS	FULL SYSTEM	ACIER INOX	525163
TÉNÉRÉ 700	700	2019	2020	LV ONE EVO	SLIP-ON	ACIER INOX	525032
TÉNÉRÉ 700	700	2021	2022	LV ONE EVO	SLIP-ON	ACIER INOX	525032
TÉNÉRÉ 700	700	2019	2020	LV ONE EVO BLACK EDITION	SLIP-ON	ACIER INOX	525033
TÉNÉRÉ 700	700	2021	2022	LV ONE EVO BLACK EDITION	SLIP-ON	ACIER INOX	525033
TRACER 7	700	2020	2022	LV ONE EVO	FULL SYSTEM	ACIER INOX	525047
TRACER 7 GT	700	2020	2022	LV ONE EVO	FULL SYSTEM	ACIER INOX	525047
TRACER 7	700	2020	2022	LV ONE EVO	FULL SYSTEM	ACIER INOX	525048
TRACER 7 GT	700	2020	2022	LV ONE EVO	FULL SYSTEM	ACIER INOX	525048
TRACER 7	700	2020	2022	LV ONE EVO BLACK EDITION	FULL SYSTEM	ACIER INOX	525049
TRACER 7 GT	700	2020	2022	LV ONE EVO BLACK EDITION	FULL SYSTEM	ACIER INOX	525049
TRACER 7	700	2020	2022	LV ONE EVO BLACK EDITION	FULL SYSTEM	ACIER INOX	525050
TRACER 7 GT	700	2020	2022	LV ONE EVO BLACK EDITION	FULL SYSTEM	ACIER INOX	525050
TRACER 7	700	2020	2022	LV ONE EVO CARBON FIBER	FULL SYSTEM	FIBRE DE CARBONE	525051
TRACER 7 GT	700	2020	2022	LV ONE EVO CARBON FIBER	FULL SYSTEM	FIBRE DE CARBONE	525051
TRACER 7	700	2020	2022	LV ONE EVO CARBON FIBER	FULL SYSTEM	FIBRE DE CARBONE	525052
TRACER 7 GT	700	2020	2022	LV ONE EVO CARBON FIBER	FULL SYSTEM	FIBRE DE CARBONE	525052
MT-07	700	2021	2022	LV ONE EVO	FULL SYSTEM	ACIER INOX	525067
XSR 700/XTRIBUTE	700	2021	2022	LV ONE EVO	FULL SYSTEM	ACIER INOX	525067
YZF-R7	700	2021	2022	LV ONE EVO	FULL SYSTEM	ACIER INOX	525067
MT-07	700	2021	2022	LV ONE EVO	FULL SYSTEM	ACIER INOX	525068
XSR 700/XTRIBUTE	700	2021	2022	LV ONE EVO	FULL SYSTEM	ACIER INOX	525068
YZF-R7	700	2021	2022	LV ONE EVO	FULL SYSTEM	ACIER INOX	525068
MT-07	700	2021	2022	LV ONE EVO BLACK EDITION	FULL SYSTEM	ACIER INOX	525069
XSR 700/XTRIBUTE	700	2021	2022	LV ONE EVO BLACK EDITION	FULL SYSTEM	ACIER INOX	525069
YZF-R7	700	2021	2022	LV ONE EVO BLACK EDITION	FULL SYSTEM	ACIER INOX	525069
MT-07	700	2021	2022	LV ONE EVO BLACK EDITION	FULL SYSTEM	ACIER INOX	525070

Modèle	Cylindre	Année début	Année fin		Description	Matériau enveloppe	Réf.
XSR 700/XTribute	700	2021	2022	LV ONE EVO BLACK EDITION	FULL SYSTEM	ACIER INOX	525070
YZF-R7	700	2021	2022	LV ONE EVO BLACK EDITION	FULL SYSTEM	ACIER INOX	525070
MT-07	700	2021	2022	LV ONE EVO CARBON FIBER	FULL SYSTEM	FIBRE DE CARBONE	525071
XSR 700/XTribute	700	2021	2022	LV ONE EVO CARBON FIBER	FULL SYSTEM	FIBRE DE CARBONE	525071
YZF-R7	700	2021	2022	LV ONE EVO CARBON FIBER	FULL SYSTEM	FIBRE DE CARBONE	525071
MT-07	700	2021	2022	LV ONE EVO CARBON FIBER	FULL SYSTEM	FIBRE DE CARBONE	525072
XSR 700/XTribute	700	2021	2022	LV ONE EVO CARBON FIBER	FULL SYSTEM	FIBRE DE CARBONE	525072
YZF-R7	700	2021	2022	LV ONE EVO CARBON FIBER	FULL SYSTEM	FIBRE DE CARBONE	525072
XSR 700	700	2016	2020	GP DUALS	FULL SYSTEM	ACIER INOX	525156
XSR 700/XTribute	700	2021	2022	GP DUALS	FULL SYSTEM	ACIER INOX	525164
XSR 700/XTribute	700	2021	2022	GP DUALS	FULL SYSTEM - BLACK PAINTED HEADER PIPES	ACIER INOX	525165
XSR 700/XTribute	700	2021	2022	GP DUALS	FULL SYSTEM - BLACK PAINTED HEADER PIPES	ACIER INOX	525166
FZ8/FAZER 8	779	2010	2015	LV ONE EVO	SLIP-ON	ACIER INOX	524839
TRACER 900/FJ-09 TRACER	900	2015	2016	LV ONE EVO	FULL SYSTEM	ACIER INOX	524931
TRACER 900/FJ-09 TRACER	900	2015	2016	LV ONE EVO CARBON FIBER	FULL SYSTEM	FIBRE DE CARBONE	524932
MT-09 SP	900	2018	2020	LV ONE EVO	FULL SYSTEM	ACIER INOX	524968
XSR 900	900	2016	2020	LV ONE EVO	FULL SYSTEM	ACIER INOX	524968
TRACER 900/FJ-09 TRACER	900	2017	2020	LV ONE EVO	FULL SYSTEM	ACIER INOX	524968
TRACER 900 GT	900	2018	2020	LV ONE EVO	FULL SYSTEM	ACIER INOX	524968
MT-09/FZ-09/ABS	900	2017	2020	LV ONE EVO	FULL SYSTEM	ACIER INOX	524968
MT-09 SP	900	2018	2020	LV ONE EVO BLACK EDITION	FULL SYSTEM	ACIER INOX	524969
XSR 900	900	2016	2020	LV ONE EVO BLACK EDITION	FULL SYSTEM	ACIER INOX	524969
TRACER 900/FJ-09 TRACER	900	2017	2020	LV ONE EVO BLACK EDITION	FULL SYSTEM	ACIER INOX	524969
TRACER 900 GT	900	2018	2020	LV ONE EVO BLACK EDITION	FULL SYSTEM	ACIER INOX	524969
MT-09/FZ-09/ABS	900	2017	2020	LV ONE EVO BLACK EDITION	FULL SYSTEM	ACIER INOX	524969
MT-09 SP	900	2018	2020	LV ONE EVO	FULL SYSTEM	ACIER INOX	524970
XSR 900	900	2016	2020	LV ONE EVO	FULL SYSTEM	ACIER INOX	524970
TRACER 900/FJ-09 TRACER	900	2017	2020	LV ONE EVO	FULL SYSTEM	ACIER INOX	524970
TRACER 900 GT	900	2018	2020	LV ONE EVO	FULL SYSTEM	ACIER INOX	524970
MT-09/FZ-09/ABS	900	2017	2020	LV ONE EVO	FULL SYSTEM	ACIER INOX	524970
MT-09 SP	900	2018	2020	LV ONE EVO BLACK EDITION	FULL SYSTEM	ACIER INOX	524971
XSR 900	900	2016	2020	LV ONE EVO BLACK EDITION	FULL SYSTEM	ACIER INOX	524971
TRACER 900/FJ-09 TRACER	900	2017	2020	LV ONE EVO BLACK EDITION	FULL SYSTEM	ACIER INOX	524971
TRACER 900 GT	900	2018	2020	LV ONE EVO BLACK EDITION	FULL SYSTEM	ACIER INOX	524971
MT-09/FZ-09/ABS	900	2017	2020	LV ONE EVO BLACK EDITION	FULL SYSTEM	ACIER INOX	524971
MT-09 SP	900	2018	2020	LV ONE EVO CARBON FIBER	FULL SYSTEM	FIBRE DE CARBONE	524972
XSR 900	900	2016	2020	LV ONE EVO CARBON FIBER	FULL SYSTEM	FIBRE DE CARBONE	524972

Modèle	Cylindre	Année début	Année fin		Description	Matériau enveloppe	Réf.
TRACER 900/FJ-09 TRACER	900	2017	2020	LV ONE EVO CARBON FIBER	FULL SYSTEM	FIBRE DE CARBONE	524972
TRACER 900 GT	900	2018	2020	LV ONE EVO CARBON FIBER	FULL SYSTEM	FIBRE DE CARBONE	524972
MT-09/FZ-09/ABS	900	2017	2020	LV ONE EVO CARBON FIBER	FULL SYSTEM	FIBRE DE CARBONE	524972
MT-09 SP	900	2018	2020	LV ONE EVO CARBON FIBER	FULL SYSTEM	FIBRE DE CARBONE	524973
XSR 900	900	2016	2020	LV ONE EVO CARBON FIBER	FULL SYSTEM	FIBRE DE CARBONE	524973
TRACER 900/FJ-09 TRACER	900	2017	2020	LV ONE EVO CARBON FIBER	FULL SYSTEM	FIBRE DE CARBONE	524973
MT-09/FZ-09/ABS	900	2017	2020	LV ONE EVO CARBON FIBER	FULL SYSTEM	FIBRE DE CARBONE	524973
TRACER 900 GT	900	2018	2020	LV ONE EVO CARBON FIBER	FULL SYSTEM	FIBRE DE CARBONE	524973
MT-09	900	2021	2022	LV RACE	FULL SYSTEM	ACIER INOX	525089
MT-09 SP	900	2021	2022	LV RACE	FULL SYSTEM	ACIER INOX	525089
MT-09	900	2021	2022	LV RACE	FULL SYSTEM	ACIER INOX	525090
MT-09 SP	900	2021	2022	LV RACE	FULL SYSTEM	ACIER INOX	525090
TRACER 9	900	2021	2022	LV RACE	FULL SYSTEM	ACIER INOX	525091
TRACER 9 GT	900	2021	2022	LV RACE	FULL SYSTEM	ACIER INOX	525091
FZ1	1000	2006	2015	LV ONE	SLIP-ON	ACIER INOX	524847
FAZER/GT	1000	2006	2015	LV ONE	SLIP-ON	ACIER INOX	524847
FJR1300 A/AS	1300	2001	2015	LV ONE EVO	2 SLIP-ON	ACIER INOX	524868



498872



498874



498875



498876



498877



498878



498880



508658



517320



519550



520963



520964



520965



520966



520967



520968



524826



524827



524828



524834



524835



524836



524837



524839



524840



524841



524842



524843



524844



524845



524846



524847



524848



524849



524850



524851



524852



524853



524854



524855



524856



524857



524858



524859



524860



524861



524862



524863

MOTEUR

CYCLE

PNEUMATIQUE

ATELIER

ACCESSOIRES

ÉLECTRICITÉ

FILTRATION

FREINAGE

TRANSMISSION



524864



524865



524868



524869



524870



524871



524872



524873



524874



524875



524876



524877



524881



524882



524883



524884



524885



524886



524887



524888



524889



524890



524891



524892



524893



524894



524895



524896



524897



524898



524899



524900



524901



524902



524903



524904



524905



524906



524907



524908



524909



524910



524911



524912



524913



524914



524915



524916



524917



524918



524919



524920



524921



524922



524923



524924



524925



524926



524927



524928



524929



524930



524931



524932

MOTEUR

CYCLE

PNEUMATIQUE

ATELIER

ACCESSOIRES

ÉLECTRICITÉ

FILTRATION

FREINAGE

TRANSMISSION



524933



524934



524935



524936



524937



524938



524940



524941



524942



524943



524944



524945



524946



524947



524948



524949



524950



524951



524952



524955



524956



524957



524958



524959



524960



524964



524965



524966



524967



524968



524969



524970



524971



524972



524973



524975



524976



524978



524979



524980



524981



524983



524984



524985



524986



524987



524988



524989



524990



524991



524992



524993



524994



524995



524996



524997



524998



524999



525001



525002



525004



525005



525006



525007

MOTEUR

CYCLE

PNEUMATIQUE

ATELIER

ACCESSOIRES

ÉLECTRICITÉ

FILTRATION

FREINAGE

TRANSMISSION



525008



525009



525010



525011



525016



525018



525019



525020



525024



525025



525026



525027



525028



525029



525030



525031



525032



525033



525034



525035



525036



525037



525038



525039



525040



525041



525042



525043



525044



525045



525046



525047



525048



525049



525050



525051



525052



525053



525054



525055



525056



525057



525058



525059



525060



525061



525062



525063



525064



525065



525066



525067



525068



525069



525070



525071



525072



525073



525074



525075



525076



525077



525078



525079

MOTEUR
CYCLE
PNEUMATIQUE
ATELIER
ACCESSOIRES
ÉLECTRICITÉ
FILTRATION
FREINAGE
TRANSMISSION



525080



525081



525082



525083



525084



525085



525086



525087



525088



525089



525090



525091



525092



525093



525094



525095



525096



525097



525098



525099



525100



525101



525102



525103



525104



525105



525106



525107



525108



525109



525110



525111



525112



525113



525114



525115



525116



525117



525118



525119



525120



525121



525122



525123



525124



525125



525126



525127



525128



525129



525130



525131



525132



525133



525134



525135



525136



525137



525138



525139



525140



525141



525142



525143

MOTEUR

CYCLE

PNEUMATIQUE

ATELIER

ACCESSOIRES

ÉLECTRICITÉ

FILTRATION

FREINAGE

TRANSMISSION



525144



525145



525146



525147



525148



525151



525152



525153



525154



525155



525156



525157



525159



525160



525161



525162



525163



525164



525165



525166



525167



525168



525169



525170



525171



525172



525173



525174



525175



525176



525177



525178



525179



525180



525181



525182



525183



525184



525185



525186



525187



525188



525189



525190



525191



525192



525193



525194



525195



525196



525197



525198



525199



525200



525201



525202



525203



525205



525206



525207



525208



525209



525210



525211

MOTEUR

CYCLE

PNEUMATIQUE

ATELIER

ACCESSOIRES

ÉLECTRICITÉ

FILTRATION

FREINAGE

TRANSMISSION



525212



525213



525214



525215



525216



525217



525218



525219



525220



525221



525222



525223



525224



525225



525226



525227



525228



525229



525230

ÉCHAPPEMENT / EXHAUST



/ EMBIELLAGE TYPE ORIGINE



473371

488114

494594

488115

488112

Désignation	Réf.
EMBIELLAGE MAXI SCOOTER TOP PERF TYPE ORIGINE ADAPT. 125 SKYLINER/MAJESTY/MADISON/VELVET	473371
EMBIELLAGE MAXI SCOOTER TOP PERF TYPE ORIGINE ADAPT. 125 SYM SYMPHONY/FIDDLE II/JET 4	488114
EMBIELLAGE MAXI SCOOTER TOP PERF TYPE ORIGINE ADAPT. 125 XMAX/SKYCRUISER/XCITY/CITYLINER	494594
EMBIELLAGE MAXI SCOOTER TOP PERF TYPE ORIGINE ADAPT. 125/150 KYMCO AGILITY/PEOPLE/VIVIO	488115
EMBIELLAGE MAXI SCOOTER TOP PERF TYPE ORIGINE ADAPT. 125 VESPA ET3	488112



494098

510378

504755

499268

499269

483335

482742

504754

/ EMBIELLAGE MAXI SCOOTER

Désignation	SELECTION CGN MOTORISE	MBK/YAMAHA	TEKNIX
EMBIELLAGE MAXI SCOOTER ADAPT. 125 KYMCO DOWNTOWN/DINK STREET/PEOPLE GT/K-XCT/X-TOWN	494098		
EMBIELLAGE MAXI SCOOTER OEM 125 YAMAHA XMAX/MBK SKYCRUISER/EVOLIS (39DE14003000)		510378	
EMBIELLAGE MAXI SCOOTER TEKNIX ADAPT. 125 HONDA SH/DYLAN/NES/PANTHEON/PSI/SILVER WING			504755
EMBIELLAGE MAXI SCOOTER TEKNIX ADAPT. 125 PIAGGIO BEVERLY/MP3/X7 EVO/X10/ VESPA GTS			499268
EMBIELLAGE MAXI SCOOTER TEKNIX ADAPT. 125 PIAGGIO VESPA/FLY/LIBERTY			499269
EMBIELLAGE MAXI SCOOTER TEKNIX ADAPT. 125 YAMAHA MAJESTY/MBK SKYLINER			483335
EMBIELLAGE MAXI SCOOTER TEKNIX ADAPT. 125 YAMAHA XMAX/MBK SKYCRUISER/EVOLIS			482742
EMBIELLAGE MAXI SCOOTER TEKNIX ADAPT. 125 YAMAHA XMAX/MBK SKYCRUISER/EVOLIS (AVEC ROULEMEN)			504754



/ EMBIELLAGE MOTO



516994

505054

Désignation	Réf.
EMBIELLAGE MOTO ADAPT. 125 YAMAHA YZF/MT/WR/RIEJU MARATHON/RS3	516994
EMBIELLAGE MOTO ADAPT. 125 YAMAHA YZF/MT/WR/RIEJU MARATHON/RS3 - MADE IN CE -	505054

/ JOINT SPI VILO



490417

510475

Désignation	SELECTION CGN MOTORISE	MBK/YAMAHA
JOINT SPI VILO MAXI SCOOTER ADAPT. 125 XMAX/EVOLIS/SKYCRUISER (25X40X5) (XI)	490417	
JOINT SPI VILO MAXI SCOOTER OEM 125 XMAX/EVOLIS/SKYCRUISER (25X40X5) GAUCHE (9310225218000)		510475

/ PIGNON POMPE A HUILE



510382



510608

Désignation	MB/ YAMAHA	GRUPE PIAGGIO
PIGNON POMPE A HUILE OEM 125 YAMAHA XMAX/MBK SKYCRUISER (1B9E33240000)	510382	
PIGNON POMPE A HUILE OEM PIAGGIO HUILE/EAU LC (289262)		510608



/ ROULEMENT EMBIELLAGE

Désignation	Réf.
ROULEMENT EMBIELLAGE MAXI SCOOTER OEM 125 YAMAHA XMAX/MBK SKYCRUISER/YZF (93306305YF00)	510379



520850



7961



515588



3275



515587



489849

/ ROULEMENT VILO

Désignation	SKF	SELECTION CGN MOTORISE
ROULEMENT VILO 6202 SKF CAGE ACIER C4 (D15X35 EP11) (X1)	520850	
ROULEMENT VILO 6303 C4 SKF CAGE ACIER (D17X47 EP14) (X1)	515588	
ROULEMENT VILO 6303 C4 SKF CAGE POLYAMIDE (D17X47 EP14) (X1)	489849	
ROULEMENT VILO 6204 C4 SKF CAGE POLYAMIDE I (X1)	7961	
ROULEMENT VILO CYCLO 6202 ZKL CAGE ACIER (D15X35 EP11) (X1)		3275
ROULEMENT VILO CYCLO 6203 C4 SKF (D17X40 EP12) (X1)	515587	



510492



503688



503726



503731



503732



503693



503720



482829



482828

/ TAMBOUR/CLOCHE EMBRAYAGE

Désignation	MB/ YAMAHA	POLINI	TOP PERF TYPE ORIGINE
MAXI SCOOTER OEM YAMAHA MINARELLI 125 (1B9E66111000)	510492		
MAXI SCOOTER POLINI EVO ADAPT. 125 FORZA 2015->		503688	
MAXI SCOOTER POLINI EVO ADAPT. 125 PIAGGIO LIBERTY		503726	
MAXI SCOOTER POLINI EVO ADAPT. 125 PIAGGIO MEDLEY/VESPA GTS EURO4		503731	
MAXI SCOOTER POLINI EVO ADAPT. 125 SYM CRUISYM EURO4		503732	
MAXI SCOOTER POLINI EVO ADAPT. 125/150 HONDA PCX 2012->/SH EURO4		503693	
MAXI SCOOTER POLINI EVO ADAPT. 400/500 PIAGGIO MP3		503720	
MAXI SCOOTER TOP PERF ADAPT. PIAGGIO 125 4T. TYPE ORIGINE			482829
MAXI SCOOTER TOP PERF ADAPT. YAMAHA MINARELLI 125 4T. TYPE ORIGIN			482828



520613



483501



483502



508660

/ DISQUE EMBRAYAGE

Désignation	MALOSSİ	POLINI	NEWFREN
DISQUE EMBRAYAGE MAXI SCOOTER MALOSSİ ADAPT. 530/560 YAMAHA TMAX/ 550 KYMCO AK + RESSORTS	520613		
DISQUE EMBRAYAGE MAXI SCOOTER POLINI ADAPT. 500 YAMAHA TMAX (JEU) + RESSORTS		483501	
DISQUE EMBRAYAGE MAXI SCOOTER POLINI ADAPT. 530 YAMAHA TMAX/ 550 KYMCO AK + RESSORTS		483502	
DISQUE EMBRAYAGE MOTO NEWFREN ADAPT. YAMAHA 125 YZF-R 14-18/MT 14-19/ HONDA 125 CBF 09-19			508660



/ ECROU EMBRAYAGE

Désignation	Réf.
ECROU EMBRAYAGE MAXI SCOOTER OEM 125 YAMAHA XMAX/SKYCRUISER/EVOLIS (1B9E76681000)	510495



461358



467664



487577

/ EMBRAYAGE DELTA CLUTCH

Désignation	MALOSSİ	POLINI
EMBAYAGE MAXI SCOOTER MALOSSİ DELTA CLUTCH ADAPT. 125 X9/X8/GEOPOLIS/SATELIS (D.134)	461358	
EMBAYAGE MAXI SCOOTER MALOSSİ DELTA CLUTCH ADAPT. 125 YAMAHA XMAX (D.135)	467664	
EMBAYAGE MAXI SCOOTER POLINI CLUTCH 2G ADAPT. 400/500 METROPOLIS/SATELIS/NEXUS/MP3/X9		487577



/ EMBRAYAGE FOR RACE

Désignation	Réf.
EMBAYAGE MAXI SCOOTER POLINI FOR RACE ADAPT. 125 PEUGEOT SATELIS EURO3/300 MP3 YOURBAN	503714
EMBAYAGE MAXI SCOOTER POLINI FOR RACE ADAPT. 125 PIAGGIO LIBERTY EURO4	503725
EMBAYAGE MAXI SCOOTER POLINI FOR RACE ADAPT. 125 PIAGGIO MEDLEY EURO/VESPA GTS 4	503730
EMBAYAGE MAXI SCOOTER POLINI FOR RACE ADAPT. 125 YAMAHA XMAX EURO4 2018->	503747
EMBAYAGE MAXI SCOOTER POLINI FOR RACE ADAPT. 125/150 KYMCO/HONDA/YAMAHA	503692



503714



503725



503730



503747



503692



/ EMBRAYAGE

Désignation	TEKNIX	TOP PERFORMANCES	TOP PERF TYPE ORIGINE
EMBRAYAGE MAXI SCOOTER TEKNIX ADAPT. 125 4 TEMPS CHINOIS GY6	500933		
EMBRAYAGE MAXI SCOOTER TEKNIX ADAPT. 125 4 TEMPS CHINOIS GY6 (COMPLET)	500934		
EMBRAYAGE MAXI SCOOTER TEKNIX ADAPT. 125 HONDA PCX	500935		
EMBRAYAGE MAXI SCOOTER TEKNIX ADAPT. 125 HONDA SH/KYMC O AGILITY/SYM/TWEET/GY6	484563		
EMBRAYAGE MAXI SCOOTER TEKNIX ADAPT. 125 KYMCO AGILITY (COMPLET)	489507		
EMBRAYAGE MAXI SCOOTER TEKNIX ADAPT. 125 PIAGGIO (COMPLET)	489506		
EMBRAYAGE MAXI SCOOTER TEKNIX ADAPT. 125 PIAGGIO MP3/LIBERTY/VESPA GTS/ET4/X7/X8/X9 03->	489505		
EMBRAYAGE MAXI SCOOTER TEKNIX ADAPT. 125 PIAGGIO/VESPA ET4/LX	500940		
EMBRAYAGE MAXI SCOOTER TEKNIX ADAPT. 125 SUZUKI BURGMAN 2002->2006	485718		
EMBRAYAGE MAXI SCOOTER TEKNIX ADAPT. 125 SUZUKI BURGMAN 2007->2012	485717		
EMBRAYAGE MAXI SCOOTER TEKNIX ADAPT. 125 SYM FIDDLE	500939		
EMBRAYAGE MAXI SCOOTER TEKNIX ADAPT. 125 XMAX/EVOLIS/SKYCRUISER	495045		
EMBRAYAGE MAXI SCOOTER TEKNIX ADAPT. 125 YAMAHA MAJESTY/SKYLINER/XN 1998-2002	489504		
EMBRAYAGE MAXI SCOOTER TEKNIX ADAPT. 125 YAMAHA NMAX	500937		
EMBRAYAGE MAXI SCOOTER TEKNIX ADAPT. 125/150 HONDA SH/PANTHEON/SWING/DYLAN (COMPLET)	489508		
EMBRAYAGE MAXI SCOOTER TEKNIX ADAPT. 250/300 PIAGGIO/VESPA MP3/GTS	500941		
EMBRAYAGE MAXI SCOOTER TEKNIX ADAPT. 400 PIAGGIO MP3/BEVERLY EURO3	495311		
EMBRAYAGE MAXI SCOOTER TOP PERF ADAPT. 125 HONDA PCX TYPE ORIGINE		490522	
EMBRAYAGE MAXI SCOOTER TOP PERF ADAPT. 125 HONDA SH TYPE ORIGINE		490647	
EMBRAYAGE MAXI SCOOTER TOP PERF ADAPT. 125 PIAGGIO/GILERA/VESPA 4 TEMPS TYPE ORIGINE		482826	
EMBRAYAGE MAXI SCOOTER TOP PERF ADAPT. 125 SUZUKI BURGMAN K7. TYPE ORIGINE		490648	
EMBRAYAGE MAXI SCOOTER TOP PERF ADAPT. 125 SYM SYMPHONY/PEUGEOT TWEET TYPE ORIGINE		490650	
EMBRAYAGE MAXI SCOOTER TOP PERF ADAPT. 125 VESPA SPRINT 4 TEMPS 3V TYPE ORIGINE			499549
EMBRAYAGE MAXI SCOOTER TOP PERF ADAPT. 125 XMAX/SKYCRUISER/EVOLIS TYPE ORIGINE		485719	
EMBRAYAGE MAXI SCOOTER TOP PERF ADAPT. 125 YAMAHA MINARELLI MAJESTY/SKYLINER/TEOS/MAXTER			482825
EMBRAYAGE MAXI SCOOTER TEKNIX ADAPT. 500 PIAGGIO/GILERA X9/NEXUS/ATLANTIC/SCARABEO	495312		



478042

492447

520614

478246

503724

503749

503687

503701

500102

/ RESSORT EMBRAYAGE

Désignation	MALOSSI	POLINI	STAGE6
MAXI SCOOTER MALOSSI ADAPT. 125 SKYLINER/MAJESTY/250 APRILIA LEONARDO	478042		
MAXI SCOOTER MALOSSI ADAPT. 125/300/400/500 APRILIA/KYMCO/PIAGGIO/PEUGEOT	492447		
MAXI SCOOTER MALOSSI ADAPT. 530/560 YAMAHA TMAX/KYMCO AK 550	520614		
MAXI SCOOTER MALOSSI RACING ADAPT.125 XMAX (X3) TYPE ORIGINE	478246		
MAXI SCOOTER POLINI ADAPT. 125 PIAGGIO LIBERTY 3V		503724	
MAXI SCOOTER POLINI ADAPT. 125 YAMAHA XMAX 2018->		503749	
MAXI SCOOTER POLINI ADAPT. 125/300/400/500		503687	
MAXI SCOOTER POLINI ADAPT. 500/530 YAMAHA TMAX/KYMCO AK 550		503701	
MAXI SCOOTER STAGE6 MAXIDRIVE ADAPT.PIAGGIO 125 MP3/VESPA/LX			500102



/ JOINT SPI CARTER MOTEUR

Désignation	Réf.
XMAX/SKYCRUISER/XCITY 9310112018	510483



/ JOINT SPI ARBRE TRANSMISSION

Désignation	Réf.
XMAX/MBK SKYCRUISER 931023200400	510499



/ ROULEMENT CARTER VARIATEUR

Désignation	Réf.
XMAX/SKYCRUISER/XCITY 93306906Y2	510496



/ ROULEMENT ENGRENAGE

Désignation	Réf.
6000 - XMAX/MBK SKYCRUISER - 93306302X900	510497
62/22 C3 - XMAX/MBK SKYCRUISER 93306272Y100	510498



510482



510479



511637



510481



/ JOINT CARTER

Désignation	Réf.
JOINT CARTER MOTEUR DROIT MAXI SCOOTER OEM 125 YAMAHA XMAX/SKYCRUISER 39DE54530000	510482
JOINT CARTER TRANSMISSION MAXI SCOOTER OEM 125 YAMAHA XMAX/SKYCRUISER 1B9154610000	510479
JOINT CARTER VARIATEUR MAXI SCOOTER OEM YAMAHA 125 MAJESTY/SKYLINER (5DSE54511000)	511637
JOINT CARTER VARIATEUR MAXI SCOOTER OEM 125 YAMAHA XMAX/SKYCRUISER (1B9E54510000)	510481



/ JOINT TORIQUE

Désignation	Réf.
JOINT TORIQUE (COFFRET DE 225 PCS PANACHES)	498848

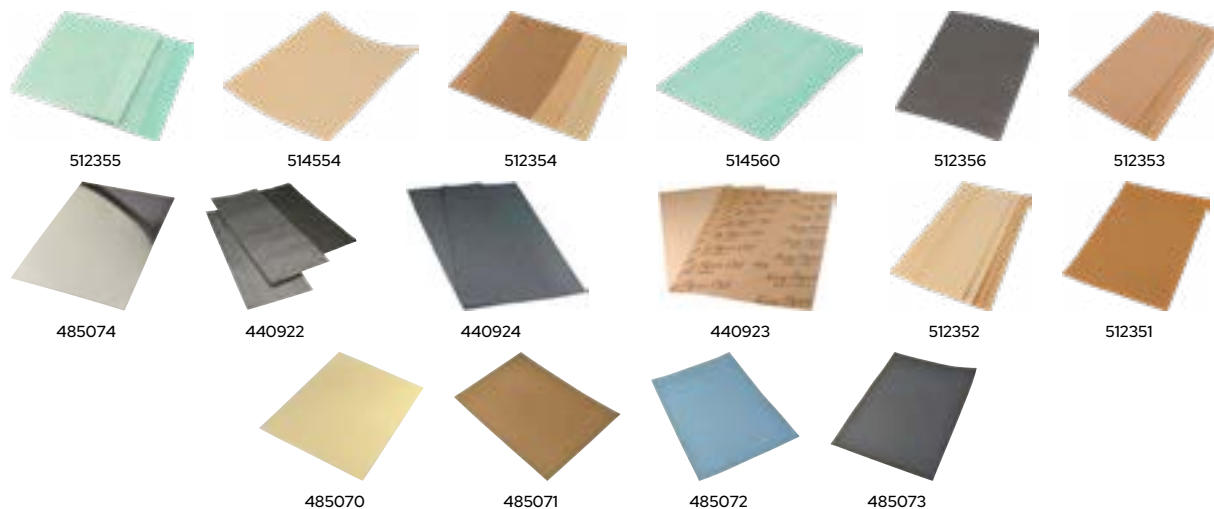

/ JOINT PLAT

Désignation	SELECTION CGN MOTORISE	ARTEIN
JOINT PLAT 200X150MM PAPIER CARTON (4 FEUILLES EPAISSEUR 0.30/2X0.50/1.00MM)	512355	
JOINT PLAT 200X150MM PAPIER CARTON (EPAISSEUR 1.00MM)	514554	
JOINT PLAT 200X150MM PAPIER HUILE (4 FEUILLES EPAISSEUR 0.15/0.25/2X0.50MM)	512354	
JOINT PLAT 200X150MM PAPIER HUILE (EPAISSEUR 0.50MM)	514560	
JOINT PLAT 200X150MM PAPIER RENFORCE ARME - EPAISSEUR 1.00MM	512356	
JOINT PLAT 475X210MM GOMME DE LIEGE 1.0/1.5/2.0MM (3 FEUILLES)	512353	
JOINT PLAT ALU 0.35 MM (FEUILLE A4 21X29.7 CM)	485074	
JOINT PLAT ARTEIN 195X475 CARTON PRESSE 0.30 X1/0.50 X 2/0.8MM (KIT)		440922
JOINT PLAT ARTEIN 195X475 MAT ARMEE 0.8/1.2MM (KIT)		440924
JOINT PLAT ARTEIN 195X475 PAPIER HUILE 0.15/0.25/0.50MM (KIT)		440923
JOINT PLAT PAPIER (4 FEUILLES 475X210MM-EPAISSEUR 0.15/0.25/2X0.50MM)	512352	
JOINT PLAT PAPIER 0.25 MM (FEUILLE A4 21X29.7 CM)	512351	
JOINT PLAT PAPIER 0.3 MM (FEUILLE A4 21X29.7 CM)	485070	
JOINT PLAT PAPIER 0.5 MM (FEUILLE A4 21X29.7 CM)	485071	
JOINT PLAT PAPIER FIBRE 0.5 MM (FEUILLE A4 21X29.7 CM)	485072	
JOINT PLAT PAPIER GRAPHITE RENFORCE 1.2 MM (FEUILLE A4 21X29.7 CM)	485073	



/ BOUCHON D'HUILE

Désignation	Réf.
BOUCHON HUILE MAXI SCOOTER OEM 125 YAHAMA XMAX/SKYCRUISER (3VLE53630000)	510477





/ BOUCHON DE VASE D'EXPANSION EAU



Désignation	Réf.
XMAX/MBK SKYCRUISER 5DSF17710000	510415



/ COLLIER DE DURITE D'EAU



Désignation	Réf.
COLLIER DE DURITE D'EAU KRM INOX 16/25MM	515366



/ CALORSTAT



511632 510412

Désignation	Réf.
MAJESTY/MBK SKYLINER - 1COE24110000	511632
XMAX/MBK SKYCRUISER (1B9124110000)	510412



/ COLLIER DE SERRAGE



506937 506938

Désignation	Réf.
METAL AJOURE 7 A 11 MM LARGEUR 5MM (XI)	506937
METAL AJOURE 9 A 14 MM LARGEUR 5MM (XI)	506938



/ COLLIER DURITE DE REFROIDISSEMENT/EAU

Désignation	Réf.
DIAMETRE 16 A 27 MM (XI) LARGEUR 9MM	483093
COFFRET PANACHE 26 PCS ET 6 DIMENSIONS	498849



483093



498849



/ JOINT DE POMPE A EAU



Désignation	Réf.
XMAX/MBK SKYCRUISER - 932108480000	510411



/ JOINT SPI DE POMPE A EAU



Désignation	Réf.
JXMAX/MBK SKYCRUISER (931031080000)	510408



/ JOINT COUVERCLE POMPE A EAU

Désignation	Réf.
MAJESTY/SKYLINER ->2009 5DSE242800	511631





519567

2262

510116

519127

519569

510117

519124

519570

519125

519568



/ DURITE EAU

Désignation	SELECTION CGN MOTORISE
DURITE EAU 12X18MM RENFORCEE/ANNELEE TRANSPARENTE 1M	519567
DURITE EAU 12X19MM 1.50M	2262
DURITE EAU 12X19MM RENFORCEE/ARMEE NOIR 1M	510116
DURITE EAU 12X19MM RENFORCEE TRANSPARENTE 1M	519127
DURITE EAU 15X22MM RENFORCEE/ANNELEE TRANSPARENTE 1M	519569
DURITE EAU 15X23MM RENFORCEE/ARMEE 1M - COMPATIBLE YAMAHA/MBK AEROX/NITRO	510117
DURITE EAU 16X22MM RENFORCEE TRANSPARENTE 1M	519124
DURITE EAU 19X26MM RENFORCEE/ANNELEE TRANSPARENTE 1M	519570
DURITE EAU 9X15MM RENFORCEE TRANSPARENTE 1M	519125
DURITE EAU 9X15MM RENFORCEE/ANNELEE TRANSPARENTE 1M	519568



510407



515132



509319



509320

/ POMPE A EAU

Désignation	MB/ YAMAHA	SELECTION CGN MOTORISE
POMPE A EAU MAXI SCOOTER OEM 125 YAMAHA XMAX/MBK SKYCRUISER - 1B9E24200200	510407	
POMPE A EAU MAXI SCOOTER TYPE ORIGINE ADAPT. 125 PIAGGIO MP3 2010>/YOURBAN/APRILIA SRMAX		515132
POMPE A EAU MAXI SCOOTER TYPE ORIGINE ADAPT. YAMAHA 500 TMAX 2001-2007		509319
POMPE A EAU MAXI SCOOTER TYPE ORIGINE ADAPT. YAMAHA 500/530/560 TMAX 2008->		509320



/ POMPE A EAU ELECTRIQUE

Désignation	Réf.
POMPE A EAU ELECTRIQUE TUN'R 12 VOLTS NOIR	496141





483300



466774



483298



501958



517657



485662



488119



494763



482819



482820



480383



506124



482821



485661



484619



484620

/ MECANISME POMPE A EAU

Désignation	TEKNIX	TOP PERFORMANCES	TOP PERF TYPE ORIGINE	SELECTION CGN MOTORISE	BUZZETTI
MECANISME POMPE A EAU MAXI SCOOTER TEKNIX ADAPT. 125 HONDA SH/PANTHEON (KIT)	483300				
MECANISME POMPE A EAU MAXI SCOOTER TEKNIX ADAPT. 125 MAJESTY/SKYLINER -> 2006/TEOS (KIT)	466774				
MECANISME POMPE A EAU MAXI SCOOTER TEKNIX ADAPT. 125 XMAX/SKYCRUISER 2006-> (KIT)	483298				
MECANISME POMPE A EAU MAXI SCOOTER TEKNIX ADAPT. 125/200 MP3/X8/X9/GTS EURO3 06->08 (KIT)	501958				
MECANISME POMPE A EAU MAXI SCOOTER TEKNIX ADAPT. 400 PEUGEOT METROPOLIS (KIT)	517657				
MECANISME POMPE A EAU MAXI SCOOTER TEKNIX ADAPT. 400 PIAGGIO MP3 2007-> (KIT)	485662				
MECANISME POMPE A EAU MAXI SCOOTER TOP PERF ADAPT. 125 HONDA PCX/SH 2010->2017 (KIT)		488119			
MECANISME POMPE A EAU MAXI SCOOTER TOP PERF ADAPT. 125 KYMCO DOWNTOWN 2009-> 2016 (KIT)			494763		
MECANISME POMPE A EAU MAXI SCOOTER TOP PERF ADAPT. 125 MAJESTY/SKYLINER/THUNDER ->06 (KIT)		482819			
MECANISME POMPE A EAU MAXI SCOOTER TOP PERF ADAPT. 125 X8/X9/BEVERLY/HEXAGON ->04 (KIT)			482820		
MECANISME POMPE A EAU MAXI SCOOTER TOP PERF ADAPT. 125 XMAX/SKYCRUISER/CITYLINER 06-> KIT		480383			
MECANISME POMPE A EAU MAXI SCOOTER TOP PERF ADAPT. 500 KYMCO XCITING (KIT)			506124		
MECANISME POMPE A EAU MAXI SCOOTER TYPE ORIGINE ADAPT. 125 KYMCO DINK (KIT)				482821	
MECANISME POMPE A EAU MAXI SCOOTER TYPE ORIGINE ADAPT. 125 SUZUKI BURGMAN (KIT)				485661	
MECANISME POMPE A EAU MAXI SCOOTER TYPE ORIGINE ADAPT. YAMAHA 500 TMAX 2001->2007 (KIT)					484619
MECANISME POMPE A EAU MAXI SCOOTER TYPE ORIGINE ADAPT. YAMAHA 500/530/560 TMAX 2008-> (KIT)					484620



/ RADIATEUR

Désignation	Réf.
RADIATEUR MAXI SCOOTER ADAPT. 125/250/300/500 PIAGGIO MP3/500 GILERA FUOCO	516993



/ GRILLE DE RADIATEUR

Désignation	Réf.
MRT/MRT PRO/ 125 MARATHON (0/000.220.0591)	504171



/ BOUCHON DE RADIATEUR

Désignation	MB/ YAMAHA	RIEJU
BOUCHON RADIATEUR MAXI SCOOTER OEM 125 YAMAHA XMAX/MBK SKYCRUISER (5VKE24620000)	510413	
BOUCHON RADIATEUR MECABOITE OEM RIEJU MRT/MRT PRO/TANGO (0/000.410.5102)		504173
BOUCHON RADIATEUR EAU MAXI SCOOTER OEM 125 MAJESTY/MBK SKYLINER - 5MFE24620100	511634	



510413



504173



511634



/ SILENTBLOC RADIATEUR

Désignation	Réf.
SILENTBLOC RADIATEUR MAXI SCOOTER OEM 125 MAJESTY/SKYLINER/XMAX 9048020X0000	511633



/ VENTILATEUR

Désignation	Réf.
VENTILATEUR MAXI SCOOTER ADAPT. 125/250/300/400/500 MP3 PIAGGIO (58211R)	516991



/ SONDE/CAPTEUR TEMPERATURE

Désignation	Réf.
MAXI SCOOTER ADAPT. VESPA LX/S/PRIMAVERA EURO4 - 58273R/830093	510056
SCOOTER ADAPT. PIAGGIO/GILERA/VESPA (M10X1.25)	510054
SCOOTER/MAXI SCOOTER/MECABOITE DERBI/PIAGGIO/GILERA EURO4	510053



510056



510054



510053

/ VARIATEUR

Désignation	Réf.
MALOSI	
MALOSI MULTIVAR 2000 ADAPT. 125 HONDA FORZA E3/E4/E5 2016->	519572
MALOSI MULTIVAR 2000 ADAPT. 125 HONDA FORZA/PCX/SH EURO5 2021->	518103
MALOSI MULTIVAR 2000 ADAPT. 125 HONDA PCX ie EURO 3	479987
MALOSI MULTIVAR 2000 ADAPT. 125 KYMCO DOWNTOWN 2017->/X-TOWN E4/E5	519578
MALOSI MULTIVAR 2000 ADAPT. 125 KYMCO GRAND DINK (EURO 2)	480258
MALOSI MULTIVAR 2000 ADAPT. 125 KYMCO SUPER DINK/DINK STREET EURO3	477532
MALOSI MULTIVAR 2000 ADAPT. 125 KYMCO XTOWN/GRAND DINK EURO4	498809
MALOSI MULTIVAR 2000 ADAPT. 125 PEUGEOT SATELIS 4T	468760
MALOSI MULTIVAR 2000 ADAPT. 125 PEUGEOT SATELIS COMPRESSOR	468761
MALOSI MULTIVAR 2000 ADAPT. 125 SUZUKI BURGMAN	477596
MALOSI MULTIVAR 2000 ADAPT. 125 SYM GTS EURO3/ 125 PEUGEOT TWEET	478044
MALOSI MULTIVAR 2000 ADAPT. 125 SYM JET X EURO5 2023->	530029
MALOSI MULTIVAR 2000 ADAPT. 125 YAMAHA NMAX EURO5 2021->	517990
MALOSI MULTIVAR 2000 ADAPT. 125 YAMAHA NMAX/TRICITY	519577
MALOSI MULTIVAR 2000 ADAPT. 125/150 PIAGGIO MEDLEY/ VESPA GTS	516998
MALOSI MULTIVAR 2000 ADAPT. 250 YAMAHA XMAX/MAJESTY	472118
MALOSI MULTIVAR 2000 ADAPT. 300 HONDA FORZA/SH I	519579
MALOSI MULTIVAR 2000 ADAPT. 300 XMAX 2017->	500189
MALOSI MULTIVAR 2000 ADAPT. 350 BEVERLY 4V ie EURO3/X10/MP3	501672
MALOSI MULTIVAR 2000 ADAPT. 400 KYMCO XCITING	487448
MALOSI MULTIVAR 2000 ADAPT. 400 PEUGEOT METROPOLIS/SATELIS	519574
MALOSI MULTIVAR 2000 ADAPT. 400 YAMAHA XMAX/MAJESTY /MBK EVOLIS	519573
MALOSI MULTIVAR 2000 ADAPT. 400/500 SATELIS/X9/EVO/MP3	477636
MALOSI MULTIVAR 2000 ADAPT. 530 PIAGGIO MP3 €5	530028
MALOSI MULTIVAR 2000 ADAPT. 530 YAMAHA TMAX 12->16	482149
MALOSI MULTIVAR 2000 ADAPT. 530/560 YAMAHA TMAX 2017->	497284
MALOSI MULTIVAR 2000 ADAPT. 550 KYMCO AK 2017->	509512
MALOSI MULTIVAR ADAPT. 125 PIAGGIO X10/X9/X8/X7/VESPA/MP3/LIBERTY	461352
MALOSI MULTIVAR ADAPT. 125/150 YAMAHA XMAX/MAJESTY LC	461354
MALOSI MULTIVAR ADAPT. 200/250/300 X8 X9/VESPA/MP3	479796
MALOSI MULTIVAR ADAPT. 500 YAMAHA TMAX 2004-> INJECTION	461356
MALOSI MULTIVAR ADAPT. 600/650 BMW C600/C650	483745
MALOSI OVER RANGE ADAPT. 530 YAMAHA TMAX 2012->2016	482646
MALOSI OVER RANGE ADAPT. 530/560 YAMAHA TMAX 2017->	497405
POLINI	
POLINI HI-SPEED ADAPT. 110 HONDA VISION	528432
POLINI HI-SPEED ADAPT. 125 HONDA PCX 2010->/SH 150 HONDA PCX 2012->	492425
POLINI HI-SPEED ADAPT. 125 KYMCO AGILITY/LIKE/PEOPLE/SUPER8	527064
POLINI HI-SPEED ADAPT. 125 KYMCO DOWNTOWN/DINK STREET/PEOPLE GTI	492427
POLINI HI-SPEED ADAPT. 125 PIAGGIO LIBERTY IGET 3V EURO4	503721
POLINI HI-SPEED ADAPT. 125 SYM CRUISYM EURO4 2018->	502230
POLINI HI-SPEED ADAPT. 125 SYM JOYMAX/JOYRIDE 2015->	495157
POLINI HI-SPEED ADAPT. 125 YAMAHA XMAX/ MBK CITYLINER/SKYCRUISER	475653
POLINI HI-SPEED ADAPT. 125/150 CITYSTAR/DJANGO/TWEET/FIDDLE 2/GTS	490827
POLINI HI-SPEED ADAPT. 125/150 HONDA FORZA 2015->/SH/SHI 2013->	492424

Désignation	Réf.
POLINI HI-SPEED ADAPT. 125/150 PIAGGIO (LEADER) BEVERLY/FLY/X8/X9	475642
POLINI HI-SPEED ADAPT. 125/150 PIAGGIO MEDLEY/ VESPA GTS 4 SOUPAPES	496330
POLINI HI-SPEED ADAPT. 125/150 PIAGGIO VESPA 3 SOUPAPES	529970
POLINI HI-SPEED ADAPT. 125/150 PIAGGIO/VESPA 4 TEMPS - 3 SOUPAPES	485916
POLINI HI-SPEED ADAPT. 125/155 YAMAHA NMAX 2015->/TRICITY 2016->	495153
POLINI HI-SPEED ADAPT. 125/180 GILERA RUNNER/PIAGGIO TYPHOON	527061
POLINI HI-SPEED ADAPT. 300 HONDA FORZA 2018->/SH 300 EURO 3/4	527063
POLINI HI-SPEED ADAPT. 300 KYMCO X-TOWN 2016->	503709
POLINI HI-SPEED ADAPT. 300 PIAGGIO MP3 YOURBAN/GTS EURO4 2017->	503715
POLINI HI-SPEED ADAPT. 300 YAMAHA XMAX 2017->	500243
POLINI HI-SPEED ADAPT. 300/350 KAWASAKI J300/DOWNTOWN 350I	503696
POLINI HI-SPEED ADAPT. 350 BEVERLY 4V ie EURO3 / X10 /MP3	501584
POLINI HI-SPEED ADAPT. 400 PEUGEOT METROPOLIS/SATELIS 2015->	487065
POLINI HI-SPEED ADAPT. 400 YAMAHA XMAX 2013 -> 2020	527065
POLINI HI-SPEED ADAPT. 400/500 PIAGGIO MP3/X8/X9/X10/ GILERA FUOCO	481480
POLINI HI-SPEED ADAPT. 500 KYMCO XCITING	527062
POLINI HI-SPEED ADAPT. 500 YAMAHA TMAX ->2012	527066
POLINI HI-SPEED ADAPT. 530 YAMAHA TMAX 2012->2017	481474
POLINI HI-SPEED ADAPT. 530/560 YAMAHA TMAX 2017->	497315
POLINI HI-SPEED ADAPT. 550 KYMCO AK 2017->	497565
POLINI HI-SPEED ADAPT. 600/650 BMW SPORT/GT	485917
POLINI HI-SPEED ADAPT. 850 APRILIA SRV/GILERA GP 800	527060
POLINI HI-SPEED ADAPT. PIAGGIO 400 BEVERLY HPE €5	525402
POLINI HI-SPEED ADAPT. SYM 300 CRUISYM/JOYMAX/JOYRIDE/HD EURO 5	525401
POLINI HI-SPEED ADAPT. YAMAHA 125 XMAX 2021->	525400
POLINI HI-SPEED EVO 3 ADAPT. 500 YAMAHA TMAX (12 ROULEAUX)	475641
POLINI HI-SPEED EVO ADAPT. 530/560 YAMAHA TMAX 2012->	483493
POLINI HI-SPEED EVO ADAPT. 530/560 YAMAHA TMAX 2012-> + COURROIE	494283
TEKNIX	
TEKNIX ADAPT. 125 4 TEMPS CHINOIS/152QMI (6 ROULEAUX 18X14)	468857
TEKNIX ADAPT. 125 PIAGGIO LIBERTY/VESPA LX4 (6 ROULEAUX 19X15.5)	485620
TEKNIX ADAPT. 125 PIAGGIO X9/X8/MP3/TYPHOON/ET4/SR MOTARD/ZIP/LX	483284
TEKNIX ADAPT. 125 YAMAHA MAJESTY/MBK SKYLINER	483283
TEKNIX ADAPT. 125 YAMAHA NMAX	500938
TEKNIX ADAPT. 125 YAMAHA XMAX/MBK SKYCRUISER/EVOLIS	483282
TEKNIX ADAPT. 125/150 HONDA SH	489510
TEKNIX ADAPT. 125/150 KYMCO AGILITY	483287
TEKNIX ADAPT. 125/150 SUZUKI BURGMAN UH K7 02-06	489509
YASUNI	
YASUNI AXIAL ADAPT. 125 HONDA FORZA 2017-2020 EURO4	515675
YASUNI AXIAL ADAPT. 125 HONDA FORZA 2021-> EURO5	515676
YASUNI AXIAL ADAPT. 125 HONDA PCX 2018-2020 EURO4	515673
YASUNI AXIAL ADAPT. 125 HONDA PCX 2021-> EURO5	515674
YASUNI AXIAL ADAPT. 125 HONDA SH 2016-> EURO4/EURO5	515672
YASUNI AXIAL ADAPT. 125 HONDA SH/DYLAN/PS/S-WING 2012-2015 EURO3	515671
YASUNI AXIAL ADAPT. 125 KYMCO AGILITY CITY 2016->	515678

MOTEUR

CYCLE

PNEUMATIQUE

ATELIER

ACCESSOIRES

ÉLECTRICITÉ

FILTRATION

FREINAGE

TRANSMISSION

Désignation	Réf.
YASUNI AXIAL ADAPT. 125 KYMCO SUPER DINK 2017->	515677
YASUNI AXIAL ADAPT. 125 PIAGGIO LIBERTY/ VESPA LX 2016- >	515682
YASUNI AXIAL ADAPT. 125 SYM CRUISYM 2018->2021	515686
YASUNI AXIAL ADAPT. 125 SYM SYMPHONY ->2016/ PEUGEOT TWEET	515681
YASUNI AXIAL ADAPT. 125 SYM SYMPHONY 2017-2020 EURO4	515684
YASUNI AXIAL ADAPT. 125 SYM SYMPHONY 2021-> EURO5	515685
YASUNI AXIAL ADAPT. 125 YAMAHA NMAX	515690
YASUNI AXIAL ADAPT. 125 YAMAHA XMAX	515689
YASUNI AXIAL ADAPT. 250 PIAGGIO X7/X8/X9/X EVO/ VESPA GTS/GTV	515668
YASUNI AXIAL ADAPT. 300 KYMCO GRAND DINK 2016-2020	515679
YASUNI AXIAL ADAPT. 300 PIAGGIO MP3/BERVERLY/ APRILIA ATLANTIC	515669
YASUNI AXIAL ADAPT. 300 SYM CRUISYM	515687
YASUNI AXIAL ADAPT. 300 VESPA GTS/GTV	515688
YASUNI AXIAL ADAPT. 300 YAMAHA XMAX	515691
YASUNI AXIAL ADAPT. 350 KYMCO SUPER DINK 2016-2020	515680
YASUNI AXIAL ADAPT. 350 PIAGGIO BEVERLY/MP3	515683
YASUNI AXIAL ADAPT. 500 YAMAHA TMAX	515692
YASUNI AXIAL ADAPT. 530/560 YAMAHA TMAX	515693
YASUNI AXIAL ADAPT. 650 BMW SPORT/GT 2016->2020 EURO4	515670

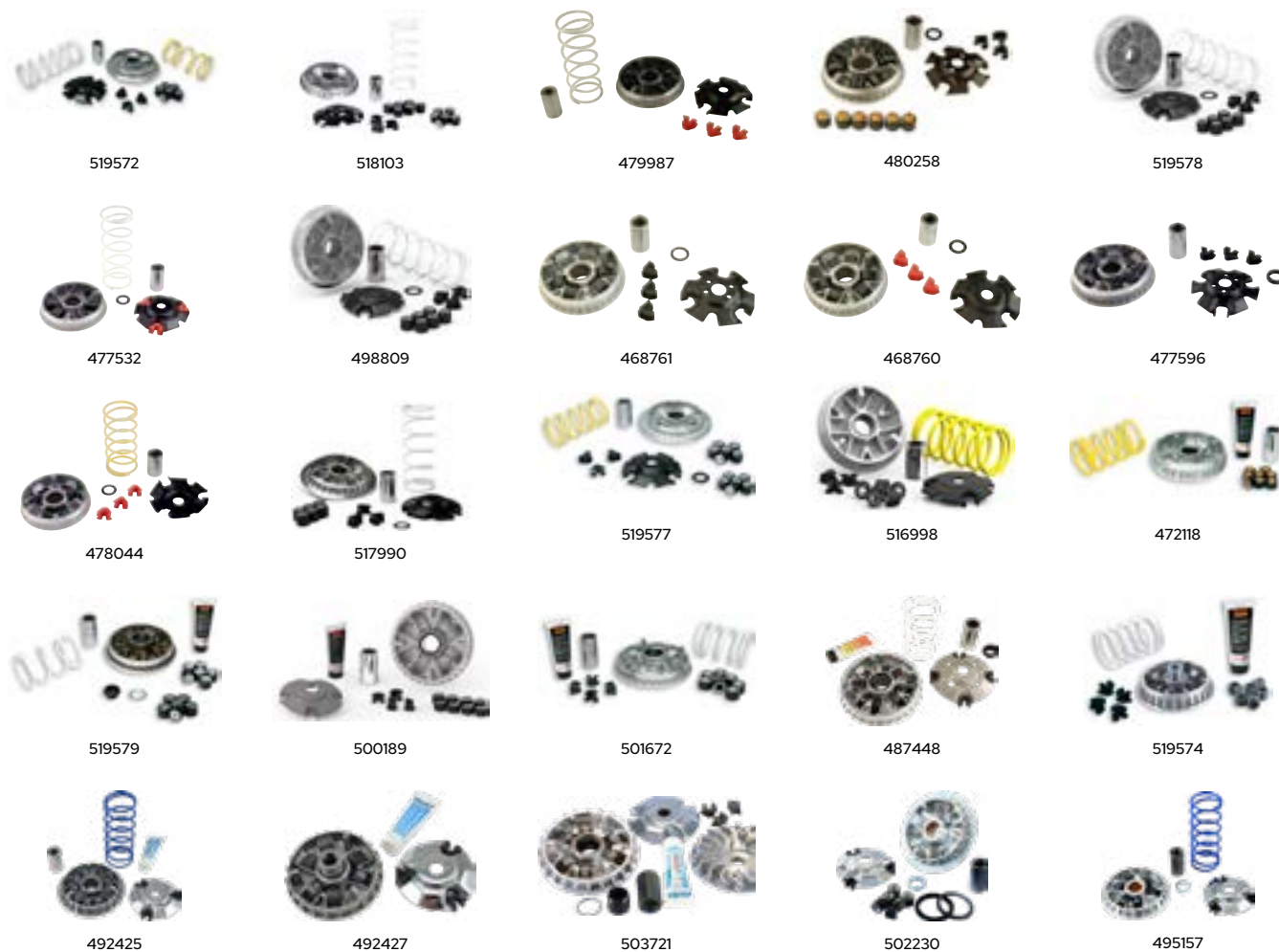



475653



490827



492424



475642



496330



485916



495153



503709



503715



500243



503696



501584



487065



481480



481474



497315



497565



485917



475641



483493



494283



519573

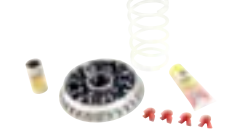

477636



482149



497284



509512



461354



461352



479796



461356



483745



482646



497405



468857



485620



483284



483283



500938



483282



489510



483287



489509



RÉFS YASUNI



/ ROULEAU/GALETs

Désignation	BANDO	MALOSSI	MBK/ YAMAHA	POLINI
18x14				
18X14 10,0 G. (X6)	499284			
18X14 10,0 G. (X6) ADAPT. 125 KYMCO DINK VARIO ORIGINE		482248		
18X14 12,0 G. (X6)	499285			
18X14 13,0 G. (X6)	499286			
18X14 13,0 G. (X6) ADAPT. 125 KYMCO DINK VARIO ORIGINE		482247		
18X14 14,0 G. (X6)	499287			
18X14 11G. (X6)		528633		
18X14 12G. (X6)		528634		
18X14 14G. (X6)		528635		
18X14 15G. (X6)		528636		
18X14 9G. (X6)		528632		
19x13,7				
19X13,7 10G. (X6)		528637		
19X13,7 11G. (X6)		528638		
19X13,7 12G. (X6)		528639		
19x17				
19X17 7,5 G. (X6)	499291			
19X17 8,5 G. (X6)	499292			
19X17 10,0 G. (X6)	499293			
19X17 11,5 G. (X6)				503727
19X17 10,7G. (X6)		528664		
19X17 10G. (X6)		528663		
19X17 12,5G. (X6)		528666		
19X17 12G. (X6)		528665		
19X17 5,4G. (X6)		528657		
19X17 6,1G. (X6)		528658		
19X17 6,6G. (X6)		528659		
19X17 7,4G. (X6)		528660		
19X17 7,7G. (X6)		528661		
19X17 9,3G. (X6)		528662		
20,9x17				
20,9X17 10G. (X6)		528668		
20,9X17 11G. (X6)		528669		
20,9X17 12G. (X6)		528717		
20,9X17 13G. (X6)		528670		

Désignation	BANDO	MALOSSI	MBK/ YAMAHA	POLINI
20,9X17 9G. (X6)		528667		
20.9X17 13.8 G. (X6)				503716
20x12				
20X12 9,0 G. (X6)	499294			
20X12 9,5 G. (X6)	499295			
20X12 10,0 G. (X6)	499296			
20X12 10,0 G. (X6)		504348		
20X12 10,1 G. (X8)				503744
20X12 11,0 G. (X6)	499297			
20X12 12,0 G. (X6)	499298			
20X12 12,0 G. (X8)	499299			
20X12 12,3 G. (X8)	499300			
20X12 13,0 G. (X6)	499301			
20X12 14,0 G. (X6)	499302			
20X12 14,0 G. (X8)	499303			
20X12 15,0 G. (X6)	499305			
20X12 15,5 G. (X8)	499304			
20X12 16,0 G. (X8)	499306			
20X12 8,0 G. (X6)		473339		
20X12 8,5 G. (X6)		472121		
20X12 9,0 G. (X8)		478038		
20X12 10,5G. (X6)		528672		
20X12 10,5G. (X8)		528721		
20X12 10G. (X8)		528720		
20X12 11,0 G. (X6)		478040		
20X12 11G. (X8)		528722		
20X12 12G. (X6)		528673		
20X12 12G. (X8)		528723		
20X12 13G. (X6)		528674		
20X12 13G. (X8)		528724		
20X12 14,5G. (X6)		528676		
20X12 14,5G. (X8)		528726		
20X12 14,1G. (X8)				503698
20X12 14G. (X6)		528675		
20X12 14G. (X8)		528725		
20X12 9,5G. (X6)		528671		
20X12 9,5G. (X8)		528719		
20X12 9G. (X8)		528718		
20x14,8				
20X14,8 11,5G. (X6)		528677		
20X14,8 13,5G. (X6)		528678		
20X14,8 15,5G. (X6)		528679		
20X14,8 17,5G. (X6)		528680		
20X14,8 8,5G. (X6)		528681		

Désignation	BANDO	MALOSSI	MBK/ YAMAHA	POLINI
20X14,8 9,5G. (X6)		528682		
20x14,5				
20X14.5 14.9 G. (X6)				503689
20x14,6				
20X14.6 10,5 G. (X6)		487021		
20X14.6 12,5 G. (X6)		487020		
20X14.6 14,5 G. (X6)		487019		
20x15				
20X15 11,0 G. (X6)	499307			
20X15 12,0 G. (X6)	499308			
20X15 12,5 G. (X6)	499309			
20X15 13,0 G. (X6)	499310			
20X15 13,5 G. (X6)	499311			
20X15 14,0 G. (X6)	499312			
20X15 14,5 G. (X6)	499313			
20X15 15,0 G. (X6)	499314			
20X15 16,0 G. (X6)	499315			
20X15 16,5 G. (X6)	499316			
20X15 17,0 G. (X6)	499317			
20x17				
20X17 8,0 G. (X6) ADAPT. 125 PIAGGIO/ YAMAHA/MBK		476500		
20X17 8,5 G. (X6) ADAPT. 125 PIAGGIO/ YAMAHA/MBK		461369		
20X17 9,0 G. (X6) ADAPT. 125 PIAGGIO/ YAMAHA/MBK		472119		
20X17 9,5 G. (X6)				503713
20X17 9,5 G. (X6) ADAPT. 125 PIAGGIO/ YAMAHA/MBK		472120		
20X17 10,5 G. (X6) ADAPT. 125 PIAGGIO/ YAMAHA/MBK		518159		
20X17 10G. (X6)		528685		
20X17 11,5 G. (X6) ADAPT. 125 PIAGGIO/ YAMAHA/MBK		472445		
20X17 12,5G. (X6)		528686		
20X17 13,5G. (X6)		528688		
20X17 13G. (X6)		528687		
20X17 14,5G. (X6)		528690		
20X17 14G. (X6)		528689		
20X17 15,5G. (X6)		528692		
20X17 15G. (X6)		528691		
20X17 17G. (X6)		528693		
20X17 18G. (X6)		528694		

Désignation	BANDO	MALOSSI	MBK/ YAMAHA	POLINI
20X17 7,5G. (X6)		528684		
20X17 7G. (X6)		528683		
23,8x18				
23,8X18 19G. (X6)		528695		
23,8X18 21G. (X6)		528696		
23,8X18 23G. (X6)		528697		
23X18 15,0 G. (X6)	499318			
23x18				
23X18 17,0 G.(X6)				503748
23X18 19,0 G. (X6)	499319			
23X18 20,0 G. (X6)	499320			
23X18 25,0 G. (X6)	499321			
23X18 11G. (X6)		528698		
23X18 12G. (X6)		528699		
23X18 13G. (X6)		528700		
23X18 14G. (X6)		528701		
23X18 15G. (X6)		528702		
23X18 16G. (X6)		528703		
23X18 17G. (X6)		528704		
23X18 18G. (X6)		528705		
23X18 19G. (X6)		528706		
23X18 20G. (X6)		528707		
23X18 22G. (X6)		528708		
23X18 25G. (X6)		528709		
23X18 27G. (X6)		528710		
25x11				
25X11 6.5 G. (X12)				489691
25X11 7.0 G. (X12)				489692
25X11 7.3 G. (X12)				489693
25X11 7.5 G. (X12)				489694
25X11 8.3 G. (X12)				489695
25X11 8.7 G. (X12)				480645
25X11 9.6 G. (X12)				480644
25x14,9				
25X14,9 06G. (X8)		528727		
25X14,9 07G. (X8)		528728		
25X14,9 10G. (X8)		528729		
25X14,9 11G. (X8)		528730		
25X14,9 12G. (X8)		528731		
25X14,9 13G. (X8)		528732		
25X14,9 14,0 G. (X8) ADAPT. YAMAHA TMAX 2004->		477226		
25X14,9 15,0 G. (X8)		504356		

Désignation	BANDO	MALOSSİ	MBK/ YAMAHA	POLINI
25X14,9 16,0 G. (X8)		478041		
25X14,9 18G. (X8)		528733		
25X14,9 20G. (X8)		528734		
25X14,9 8,0 G. (X8) ADAPT. YAMAHA 300 XMAX		510205		
25X14,8 12,0 G. (X8) ADAPT. 530 YAMAHA TMAX VARIO				482069
25X14,9 15,0 G. (X8)	499323			
25X14,9 19,0 G. (X8)	499325			
25x15				
25X15 18,0 G.(X8)				503740
25X15 14 G. (X8)				503712
25x15,9				
25X15,9 10G. (X8)		528735		
25X15,9 11G. (X8)		528736		
25X15,9 12G. (X8)		528737		
25X15,9 13G. (X8)		528738		
25X15,9 14G. (X8)		528739		
25X15,9 15G. (X8)		528740		
25X15,9 16G. (X8)		528741		
25x17				
25X17 18,5 G. (X8)	499327			
25X17 21,5 G. (X8)	499328			
25X17 13G. (X8)		528742		
25X17 14G. (X8)		528743		
25X17 15,0 G. (X8) ADAPT. 400 PIAGGIO MP3		477227		
25X17 15,0 G. (X8) ADAPT. PIAGGIO X8 VARİO ORIGİNE				481619
25X17 16,0 G. (X8) ADAPT. 400 PIAGGIO MP3		487022		
25X17 20G. (X8)		528744		
25x19				
25X19 17G. (X8)		528745		
25X19 18G. (X8)		528746		
25X19 19G. (X8)		528747		
25x22				
25X22 18,0 G. (X6)	499329			
25X22 28,5 G. (X6)	499331			
25x22,2				
25X22,2 20G. (X6)		528711		
25X22,2 22G. (X6)		528712		
25X22,2 24G. (X6)		528713		

Désignation	BANDO	MALOSSİ	MBK/ YAMAHA	POLINI
25X22,2 26G. (X6)		528714		
25X22,2 28G. (X6)		528715		
25X22,2 30G. (X6)		528716		
26x12,8				
26X12,8 14G. (X8)		528748		
26X12,8 15G. (X8)		528749		
26X12,8 16G. (X8)		528750		
26X12,8 18G. (X8)		528751		
26X12,8 21G. (X8)		528752		
28,2x19,9				
28,2X19,9 17G. (X8)		528753		
28,2X19,9 18G. (X8)		528754		
28,2X19,9 21G. (X8)		528755		
28,2X19,9 24G. (X8)		528756		
28,2X19,9 28G. (X8)		528757		
28x19,9				
28X19,9 26G. (X8)		528758		
29,8x19,8				
29,8X19,8 20G. (X8)		528759		
29,8X19,8 22G. (X8)		528760		
29,8X19,8 24G. (X8)		528761		
29,8X19,8 26G. (X8)		528762		
29,8X19,8 33G. (X8)		528763		



/ ROULEAU/GALET



Désignation	Réf.
FIDDLE IV - 22121-ARA-000-A (X6)	528552
GTS 125 EURO 4- 22121-LIN-000-A (X6)	528553
GTS 125 ISPORT EURO 4- 22121-H98-000-A (X6)	528554
10.1G. FIDDLE III/ORBIT III - 22121-HKE-000-A (X6)	528551



/ ROULEAU/GALET



Désignation	Réf.
125 YAMAHA XMAX/MBK SKYCRUISER 1B9E76320100	510487
20X12 9.1 G. 125 YAMAHA/MBK (5MLE76320000)	517274



/ ROULEAU/GALET POUR VARIATEUR AXIAL

Désignation	Réf.
20mm	
20MM 3,4G. (X10)	519308
20MM 3,7G. (X10)	519208
20MM 4G. (X10)	519207
20MM 4,2G. (X10)	519205
20MM 4,5G. (X10)	519209
20MM 4,9G. (X10)	519210
20MM 5,4G. (X10)	519211
20MM 5,7G. (X10)	519212
20MM 6G. (X10)	519206
20MM 6,4G. (X10)	519213
26mm	
26MM 6,6G. (X9)	519214
26MM 7,4G. (X9)	519216
26MM 7,8G. (X9)	519217
26MM 7G. (X9)	519215
26MM 8,3G. (X9)	519218
26MM 8,7G. (X9)	519219
26MM 9,2G. (X9)	519220
26MM 9,6G. (X9)	519221
26MM 10G. (X9)	519222
26MM 10,5G. (X9)	519223
26MM 11G. (X9)	519224
26MM 11,5G. (X9)	519225
26MM 12G. (X9)	519226
26MM 12,4G. (X9)	519227
26MM 12,8G. (X9)	519228
26MM 13,2G. (X9)	519229
26MM 13,6G. (X9)	519230

Désignation	Réf.
26MM 14G. (X9)	519231
26MM 14,5G. (X9)	519232
26MM 15G. (X9)	519233
26MM 15,3G. (X9)	519234
26MM 15,7G. (X9)	519235
26MM 16,2G. (X9)	519236
26MM 17,2G. (X9)	519237
26MM 18G. (X9)	519238
26MM 19G. (X9)	519239
26MM 19,7G. (X9)	519240
26MM 20,6G. (X9)	519241
26MM 21G. (X9)	519309
26MM 21,5G. (X9)	519242
26MM 22G. (X9)	519310
26MM 22,4G. (X9)	519243
26MM 23,2G. (X9)	519244
26MM 24G. (X9)	519245
29mm	
29MM 7,4G. (X14)	519246
29MM 8,3G. (X14)	519248
29MM 8,7G. (X14)	519249
29MM 8G. (X14)	519247
29MM 9,2G. (X14)	519250
29MM 9,6G. (X14)	519251
29MM 10G. (X14)	519252
29MM 10,5G. (X14)	519253
29MM 11G. (X14)	519254
29MM 11,3G. (X14)	519255
29MM 11,8G. (X14)	519256

Désignation	Réf.
29MM 12,4G. (X14)	519257
29MM 12,8G. (X14)	519258
29MM 13,3G. (X14)	519259
29MM 13,7G. (X14)	519260
29MM 14G. (X14)	519261
29MM 14,5G. (X14)	519262
29MM 15G. (X14)	519263
29MM 15,3G. (X14)	519264
29MM 15,8G. (X14)	519265
29MM 16,2G. (X14)	519266
29MM 16,7G. (X14)	519267
29MM 17G. (X14)	519268
29MM 18G. (X14)	519269
29MM 19G. (X14)	519270
29MM 19,7G. (X14)	519271
29MM 20,2G. (X14)	519306
29MM 20,6G. (X14)	519272
29MM 21,5G. (X14)	519273
29MM 22,3G. (X14)	519274
29MM 23,3G. (X14)	519275
29MM 24G. (X14)	519276
29MM 25G. (X14)	519277
32mm	
32MM 7,9G. (X16)	519278
32MM 8,4G. (X16)	519279
32MM 8,8G. (X16)	519280
32MM 9,3G. (X16)	519281
32MM 9,7G. (X16)	519282
32MM 10,1G. (X16)	519283

Désignation	Réf.
32MM 10,5G. (X16)	519284
32MM 11,5G. (X16)	519286
32MM 11G. (X16)	519285
32MM 12,3G. (X16)	519287
32MM 12,9G. (X16)	519288
32MM 12G. (X16)	519307
32MM 13,3G. (X16)	519289
32MM 13,8G. (X16)	519290
32MM 14,2G. (X16)	519291
32MM 14,6G. (X16)	519292
32MM 15,5G. (X16)	519203
32MM 15,8G. (X16)	519293
32MM 16,3G. (X16)	519294
32MM 16,7G. (X16)	519295
32MM 17,2G. (X16)	519296
32MM 17,6G. (X16)	519204
32MM 18,5G. (X16)	519297
32MM 19,4G. (X16)	519298
32MM 20,2G. (X16)	519299
32MM 21G. (X16)	519300
32MM 22,8G. (X16)	519302
32MM 22G. (X16)	519301
32MM 23,8G. (X16)	519303
32MM 24,6G. (X16)	519304
32MM 25,5G. (X16)	519305

MOTEUR

CYCLE

PNEUMATIQUE

ATELIER

ACCESSOIRES

ÉLECTRICITÉ

FILTRATION

FREINAGE

TRANSMISSION



/ AUTOCOLLANTS / STICKERS	94
/ DÉCORATION / DECORATION	102
/ SELLE / SADDLE	106
/ COMPTEUR / SPEEDOMETER	107
/ CÂBLE COMPTEUR / SPEEDOMETER	110
/ GUIDON // HANDLEBAR	121
/ CÂBLE FREIN / BRAKE CABLE	132
/ CÂBLE STARTER / STARTER CABLE	134
/ CÂBLE EMBRAYAGE / CLUTCH CABLE	140
/ LEVIER-POIGNEE / LEVER-HANDLE	154
/ CÂBLE GAZ / GAZ CABLE	156
/ REVÊTEMENT / GRIP	185
/ RÉTROVISEUR / WING MIRROR	194
/ BÉQUILLE / STAND	200
/ PÉDALE / PEDAL	202
/ ROUE / WHEEL	204
/ FOURCHE / FORK	206
/ JOINT SPI / FORK OIL SEAL	
• MOTO / MOTORCYCLE	207
• MAXI SCOOTER / MAXI SCOOTER	243
• OFF-ROAD / OFF ROAD	252
• MOTO ANCIENNE / OLD MOTOORCYCLE	286
/ SUPPORT / MOUNT	295
/ CARROSSERIE / BODY KIT	296
/ ECLAIRAGE / LIGHTING	302



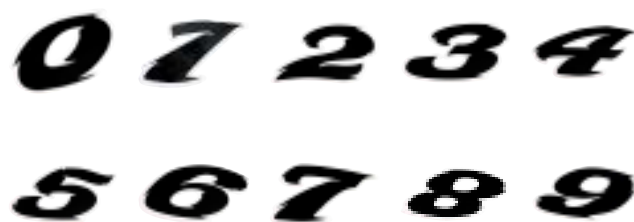

/ AUTOCOLLANT

Désignation	Réf.
NUMÉRO 0 - JAUNE	440861
NUMÉRO 1 - JAUNE	440862
NUMÉRO 2 - JAUNE	440863
NUMÉRO 3 - JAUNE	440864
NUMÉRO 4 - JAUNE	440865
NUMÉRO 5 - JAUNE	440866
NUMÉRO 6 - JAUNE	440867
NUMÉRO 7 - JAUNE	440868
NUMÉRO 8 - JAUNE	440869
NUMÉRO 9 - JAUNE	440870



/ AUTOCOLLANT

Désignation	Réf. 5,5 cm	Réf. 9 cm
• NUMÉRO 0 - NOIR	461926	461936
• NUMÉRO 1 - NOIR	461927	461937
• NUMÉRO 2 - NOIR	461928	461938
• NUMÉRO 3 - NOIR	461929	461939
• NUMÉRO 4 - NOIR	461930	461940
• NUMÉRO 5 - NOIR	461931	461941
• NUMÉRO 6 - NOIR	461932	461942
• NUMÉRO 7 - NOIR	461933	461943
• NUMÉRO 8 - NOIR	461934	461944
• NUMÉRO 9 - NOIR	461935	461945



/ AUTOCOLLANT

Désignation	Réf. 9 cm	Réf. 13 cm
NUMÉRO 0 - BLANC	449793	441651
NUMÉRO 1 - BLANC	449794	441652
NUMÉRO 2 - BLANC	449795	441653
NUMÉRO 3 - BLANC	449796	441654
NUMÉRO 4 - BLANC	449797	441655
NUMÉRO 5 - BLANC	449798	441656
NUMÉRO 6 - BLANC	449799	441657
NUMÉRO 7 - BLANC	449800	441658
NUMÉRO 8 - BLANC	449801	441659
NUMÉRO 9 - BLANC	449802	441660



/ AUTOCOLLANT

Désignation	Réf.
NUMÉRO 0 - BOMBING 10 X 7,5 CM	500692
NUMÉRO 1 - BOMBING 10 X 7,5 CM	500693
NUMÉRO 2 - BOMBING 10 X 7,5 CM	500694
NUMÉRO 3 - BOMBING 10 X 7,5 CM	500695
NUMÉRO 4 - BOMBING 10 X 7,5 CM	500696
NUMÉRO 5 - BOMBING 10 X 7,5 CM	500697
NUMÉRO 6 - BOMBING 10 X 7,5 CM	500698
NUMÉRO 7 - BOMBING 10 X 7,5 CM	500699
NUMÉRO 8 - BOMBING 10 X 7,5 CM	500700
NUMÉRO 9 - BOMBING 10 X 7,5 CM	500701



/ AUTOCOLLANT NUMERO DE COURSE MOTO

Désignation	Réf. 10 cm
0 - BLANC CONTOUR NOIR	527614
1 - BLANC CONTOUR NOIR	527615
2 - BLANC CONTOUR NOIR	527616
3 - BLANC CONTOUR NOIR	527617
4 - BLANC CONTOUR NOIR	527618
5 - BLANC CONTOUR NOIR	527619
6 - BLANC CONTOUR NOIR	527620
7 - BLANC CONTOUR NOIR	527621
8 - BLANC CONTOUR NOIR	527622
9 - BLANC CONTOUR NOIR	527623



/ AUTOCOLLANT NUMERO DE COURSE MOTO

Désignation	Réf. 10 cm
0 - NOIR CONTOUR BLANC	527624
1 - NOIR CONTOUR BLANC	527625
2 - NOIR CONTOUR BLANC	527626
3 - NOIR CONTOUR BLANC	527627
4 - NOIR CONTOUR BLANC	527628
5 - NOIR CONTOUR BLANC	527629
6 - NOIR CONTOUR BLANC	527630
7 - NOIR CONTOUR BLANC	527631
8 - NOIR CONTOUR BLANC	527632
9 - NOIR CONTOUR BLANC	527633



/ AUTOCOLLANT NUMERO DE COURSE MOTO

Désignation	Réf. 10 cm
0 - JAUNE FLUO CONTOUR NOIR	527634
1 - JAUNE FLUO CONTOUR NOIR	527635
2 - JAUNE FLUO CONTOUR NOIR	527636
3 - JAUNE FLUO CONTOUR NOIR	527637
4 - JAUNE FLUO CONTOUR NOIR	527638
5 - JAUNE FLUO CONTOUR NOIR	527639
6 - JAUNE FLUO CONTOUR NOIR	527640
7 - JAUNE FLUO CONTOUR NOIR	527641
8 - JAUNE FLUO CONTOUR NOIR	527642
9 - JAUNE FLUO CONTOUR NOIR	527643



/ AUTOCOLLANT NUMERO DE COURSE MOTO

Désignation	Réf. 10 cm
0 - ROUGE FLUO CONTOUR NOIR	527644
1 - ROUGE FLUO CONTOUR NOIR	527645
2 - ROUGE FLUO CONTOUR NOIR	527646
3 - ROUGE FLUO CONTOUR NOIR	527647
4 - ROUGE FLUO CONTOUR NOIR	527648
5 - ROUGE FLUO CONTOUR NOIR	527649
6 - ROUGE FLUO CONTOUR NOIR	527650
7 - ROUGE FLUO CONTOUR NOIR	527651
8 - ROUGE FLUO CONTOUR NOIR	527652
9 - ROUGE FLUO CONTOUR NOIR	527655



/ AUTOCOLLANT NUMERO CROSS X5

Désignation	Réf. 13 cm
0 - BLANC CONTOUR NOIR	527660
1 - BLANC CONTOUR NOIR	527661
2 - BLANC CONTOUR NOIR	527662
3 - BLANC CONTOUR NOIR	527663
4 - BLANC CONTOUR NOIR	527664
5 - BLANC CONTOUR NOIR	527665
6 - BLANC CONTOUR NOIR	527666
7 - BLANC CONTOUR NOIR	527667
8 - BLANC CONTOUR NOIR	527668
9 - BLANC CONTOUR NOIR	527669



/ AUTOCOLLANT NUMERO CROSS X5

Désignation	Réf. 13 cm
0 - BLANC CONTOUR BLANC	527670
1 - BLANC CONTOUR BLANC	527671
2 - BLANC CONTOUR BLANC	527672
3 - BLANC CONTOUR BLANC	527673
4 - BLANC CONTOUR BLANC	527674
5 - BLANC CONTOUR BLANC	527675
6 - BLANC CONTOUR BLANC	527676
7 - BLANC CONTOUR BLANC	527677
8 - BLANC CONTOUR BLANC	527678
9 - BLANC CONTOUR BLANC	527679

/ AUTOCOLLANT



513590

LION NOIR (23CM)



513591

LION BLANC (23CM)



513592

MHR NOIR (13CM)



513593

NOIR (14CM)



513594

MALOSSI GAS NOIR / ROUGE (8X14CM)

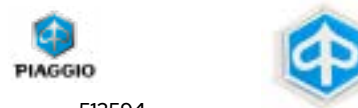

513594

ECUSSON / AUTOCOLLANT LOGO PIAGGIO
TABLIER AV SCOOTER OEM (574771)



458218

ANIMAL AIGLE ATTACK (9X8CM)



451745

ANIMAL BOULEDOG (10X10.5CM)



459642

ANIMAL GRENOUILLE FUMEUSE (10X8.5CM)

Selection CGN

458217

ANIMAL TAUREAU ATTACK (8X10CM)

Selection CGN

496004

BOMBING (35X25CM)

Selection CGN

500706

BOMBING BOMBE (10X12CM)

Selection CGN

500708

BOMBING DOIGT D'HONNEUR (10X12CM)

Selection CGN

500710

BOMBING FLAMME (10X12CM)

Selection CGN

500711

BOMBING GUN (10X12CM)

Selection CGN

500705

BOMBING MAIN COOL (10X12CM)

Selection CGN

500707

BOMBING MAIN COOL V2 (10X12CM)

Selection CGN

500713

BOMBING MIX (10X12CM)

Selection CGN

500712

BOMBING PANSEMENT (10X12CM)

Selection CGN

500715

BOMBING SALUT DE MOTARD (10X12CM)

Selection CGN

500709

BOMBING TETE DE MORT (10X12CM)

MOTEUR

CYCLE

PNEUMATIQUE

ATELIER

ACCESSOIRES

ÉLECTRICITÉ

FILTRATION

FREINAGE

TRANSMISSION

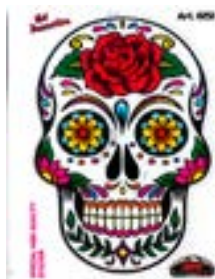

Selection
CGN

500714

BOMBING TETE DE MORT MEXICAINE
(10X12CM)



Selection
CGN

368990

CORONA EXTRA (14X16CM)



Selection
CGN

450205

CRUEL MINI BOMBE (8CM)



Selection
CGN

458947

CRUEL REGARD MECHANT BLANC
(6X10CM)



Selection
CGN

449985

CRUEL REGARD MECHANT NOIR
(6X10CM)



Selection
CGN

449982

CRUEL REGARD MECHANT ROUGE
(6X10CM)



Selection
CGN

458220

DIABLE BOUDEUR AVEC TRIDENT
(8X12CM)



Selection
CGN

441642

DIABLE EN MOTO (10CM)



Selection
CGN

458219

DIABLE GRIS AVEC TRIDENT (8X12CM)



Selection
CGN

459636

DIABLE JOKER DE LA MORT (8.2X6.9CM)



Selection
CGN

293126

DUCK (14X16CM)



Selection
CGN

368875

FUCK (10X12CM)



Selection
CGN

369025

OEIL NO FEAR (14X16CM)



Selection
CGN

441638

RACING AIGLE AMERICAIN (16.5CM)



Selection
CGN

441646

RACING FREESTYLE MOTO (8X11CM)



Selection
CGN

449996

RACING PISTONS / BOUGIE (11.5CM)



Selection
CGN

441647

RACING SCOOTER EN RAGE (10CM)



Selection
CGN

458222

SENSUEL FASHION GIRL STRING (8X10CM)



Selection
CGN

500717

SMILEY HEUREUX (10X12CM)



Selection
CGN

500718

SMILEY VULGAIRE (10X12CM)



Selection
CGN

500716

TAUREAU EN COLERE (10X12CM)



Selection
CGN

368913 (noir)

368909 (rouge)

VIRGULE (10X12CM)



Malossi

294012

MARQUE MALOSSI (PLANCHE 25X35CM)



DOPPLER

461207

PLANCHE A4 - 21X29.7CM

MOTEUR

CYCLE

PNEUMATIQUE

ATELIER

ACCESSOIRES

ÉLECTRICITÉ

FILTRATION

FREINAGE

TRANSMISSION



196707

MARQUE POLINI (PLANCHE 30X17CM)



259948

MARQUE POLINI TEAM SCOOTER 1
PLANCHE GAUCHE + 1 PLANCHE DROITE
(50X35CM)

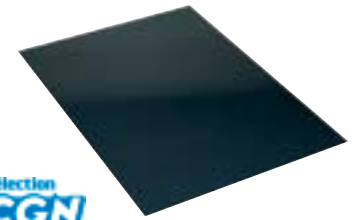

191337

CARBONE (PLANCHE 50X35CM)



293312

DAMIER NOIR / BLANC (20X24CM)



293289

FLAMMES (20X24CM)



369044

FLAMMES (20X24CM)



460916

LUBRIFIANTS (20X24CM)



451716

MARQUE SPONSORS (NGK / SKF / AFAM /
MOTUL / BREMBO (PLANCHE 35X25CM)



497371

RESERVOIR MECABOITE / MOTO
BOMBING

/ PROTECTION RESERVOIR MECABOITE/MOTO



293217

CARBONE (GRAND MODELE)



293221

PROTECTION RESERVOIR MECABOITE / MOTO
TUN'R CARBONE





485635

PROTECTION RESERVOIR BLEU
(130X190MM)



485633

PROTECTION RESERVOIR JAUNE
(130X190MM)



485636

PROTECTION RESERVOIR VERT
(130X190MM)



512065



512063

/ AUTOCOLLANT CASQUE

Désignation	Réf.
○ Réfléchissant - Blanc (sachet de 4)	512065
● Réfléchissant - Noir (sachet de 4)	512063



/ AUTOCOLLANT CASQUE

Désignation	Réf.
Réfléchissant - Noir (sachet de 4)	497241



**/ AUTOCOLLANT LISERET
POUR JANTE / CARROSSERIE**

Désignation	Réf. 7mm (6m)
Carbone pour jante / carrosserie + outil applicateur	500704



/ AUTOCOLLANT LISERET POUR JANTE / CARROSSERIE

Désignation	Réf. 6mm (10m)	Réf. 9mm (10m)
○ Autocollant liseret - Blanc	468162	468169
● Autocollant liseret - Rouge	468166	468173
● Autocollant liseret - Bleu	468163	
● Autocollant liseret - Bleu foncé		493971
● Autocollant liseret - Fluo jaune		468174
● Autocollant liseret - Fluo rouge	468315	468175
● Autocollant liseret - Fluo vert	468176	468176
● Autocollant liseret - Jaune	468167	468171
● Autocollant liseret - Noir	468165	468172
● Autocollant liseret - Or	487964	487965
● Autocollant liseret - Argent	468164	468168



/ AUTOCOLLANT LISERET POUR JANTE / CARROSSERIE

Désignation	Réf. 7mm (6m)
○ Blanc pour jante / carrosserie + outil applicateur	512627
● Bleu pour jante / carrosserie + outil applicateur	512628
● Noir pour jante / carrosserie + outil applicateur	512630
● Jaune fluo pour jante / carrosserie + outil applicateur	512629
● Or pour jante / carrosserie + outil applicateur	512631
● Orange fluo pour jante / carrosserie + outil applicateur	512632
● Rose pour jante / carrosserie + outil applicateur	512633
● Rouge pour jante / carrosserie + outil applicateur	512634
● Vert fluo pour jante / carrosserie + outil applicateur	512635
● Argent pour jante / carrosserie + outil applicateur	512626

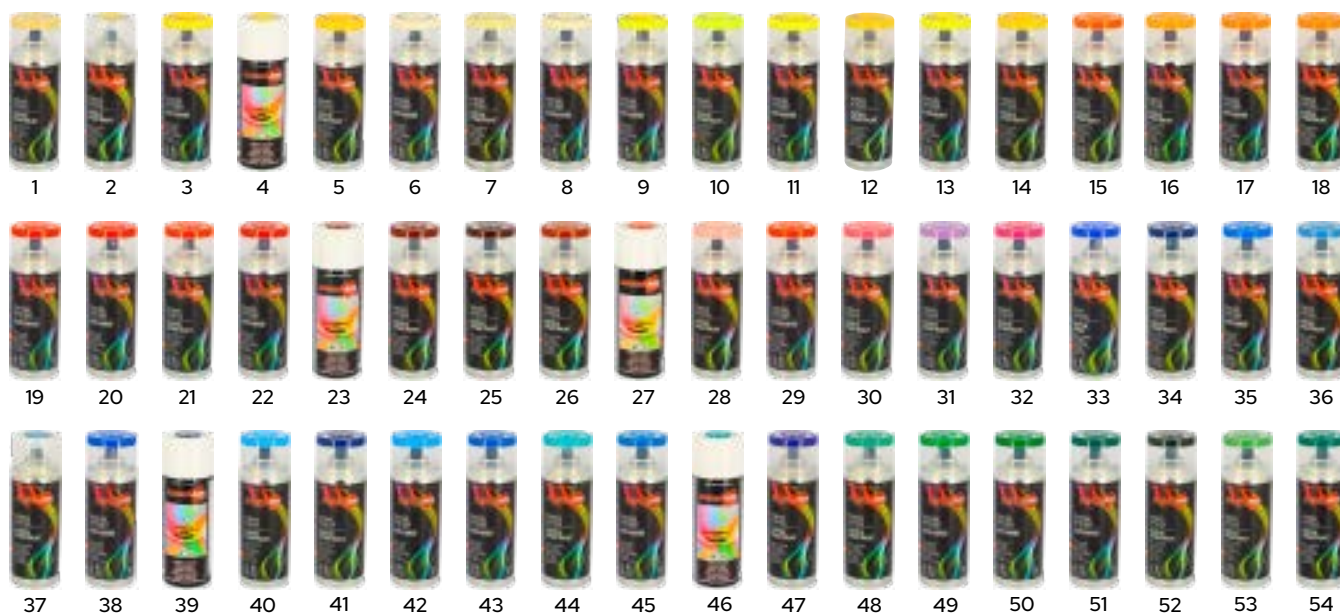

/ BOMBE PEINTURE AMBRO-SOL - AEROSOL 400ML

	Désignation	Réf.
1	RAL 1001 BEIGE	525717
2	RAL 1002 JAUNE SABLE MAT	525718
3	RAL 1003 JAUNE SIGNAL	525719
4	RAL 1004 JAUNE OR	525720
5	RAL 1007 JAUNE NARCISSE	525721
6	RAL 1013 BLANC PERLE	525722
7	RAL 1014 IVOIRE	525723
8	RAL 1015 IVOIRE CLAIR	525724
9	RAL 1021 JAUNE CADMIUM	525725
10	RAL 1016 JAUNE SOUFFRE	525726
11	RAL 1018 JAUNE ZINC	525727
12	RAL 1028 JAUNE CITRON	525728
13	RAL 1023 JAUNE TRAFIC	525729
14	RAL 1037 JAUNE SOLEIL	525730
15	RAL 2002 ORANGE SANG	525731
16	RAL 2003 ORANGE PASTEL	525732
17	RAL 2004 ORANGE PUR	525733
18	RAL 2009 ORANGE TRAFIC	525734
19	RAL 3000 ROUGE FEU	525735
20	RAL 3001 ROUGE SIGNAL	525736
21	RAL 3002 ROUGE CARMIN	525737
22	RAL 3003 ROUGE RUBIS	525738
23	RAL 3004 ROUGE POURPRE	525739
24	RAL 3005 ROUGE VIN	525740
25	RAL 3007 ROUGE NOIR	525741
26	RAL 3009 ROUGE OXYDE	525742
27	RAL 3013 ROUGE TOMATE	525743

	Désignation	Réf.
28	RAL 3015 ROSE CLAIR	525744
29	RAL 3020 ROUGE TRAFIC	525745
30	RAL 4003 VIOLET BRUYÈRE	525746
31	RAL 4005 LILAS BLEU	525747
32	RAL 4006 VIOLET POURPRE	525748
33	RAL 5002 BLEU OUTREMER	525749
34	RAL 5003 BLUE SAPHYR	525750
35	RAL 5005 BLEU SIGNAL	525751
36	RAL 5007 BLEU BRILLANT	525752
37	RAL 5009 BLEU AZUR	525753
38	RAL 5010 BLEU GENTIANE	525754
39	RAL 5011 BLEU ACIER	525755
40	RAL 5012 BLEU LUMIÈRE	525756
41	RAL 5013 BLEU COBALT	525757
42	RAL 5015 BLEU CIEL	525758
43	RAL 5017 BLEU TRAFIC	525759
44	RAL 5018 BLEU TURQUOISE	525760
45	RAL 5019 BLEU CAPRI	525761
46	RAL 5021 BLEU EAU	525762
47	RAL 5022 BLEU NUIT	525763
48	RAL 6000 VERT PATINE	525764
49	RAL 6001 VERT EMERAUDE	525765
50	RAL 6002 VERT PRINTEMPS	525766
51	RAL 6005 VERT MOUSSE	525768
52	RAL 6009 VERT SAPIN	525769
53	RAL 6011 VERT RESEDA	525770
54	RAL 6016 VERT TURQUOISE	525771

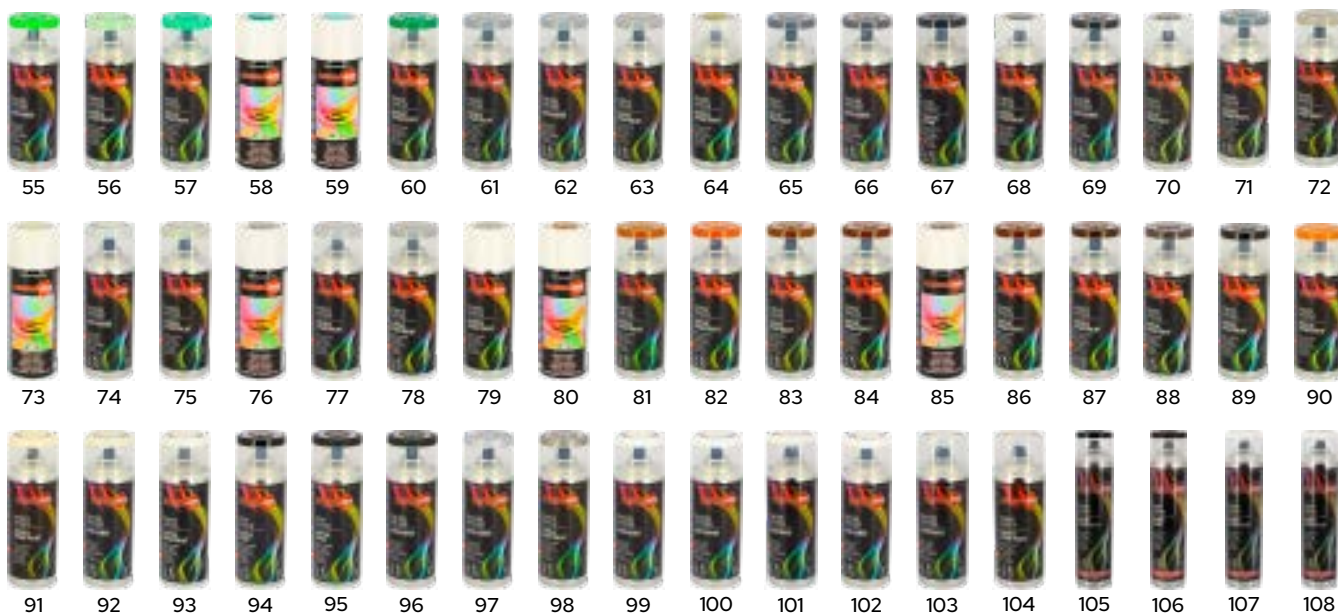

Désignation	Réf.
55 RAL 6018 VERT PELOUSE	525772
56 RAL 6019 VERT BLANC	525773
57 RAL 6024 VERT TRAFIC	525774
58 RAL 6026 VERT OPALE	525775
59 RAL 6027 VERT CLAIR	525776
60 RAL 6029 VERT MENTHE	525777
61 RAL 7000 GRIS PETIT-GRIS	525778
62 RAL 7001 GRIS ARGENT	525779
63 RAL 7004 GRIS SECURITE	525780
64 RAL 7008 GRIS KAKI MAT	525781
65 RAL 7011 GRIS FER	525782
66 RAL 7015 GRIS ARDOISE	525783
67 RAL 7016 GRIS ANTHRACITE	525784
68 RAL 7016 GRIS ANTHR. SATIN	525785
69 RAL 7021 GRIS NOIR	525786
70 RAL 7022 GRIS TERRE D' OMBRE	525787
71 RAL 7025 GRIS PERLE	525788
72 RAL 7030 GRIS PIERRE	525789
73 RAL 7032 GRIS FONCE	525790
74 RAL 7035 GRIS CLAIR	525791
75 RAL 7038 GRIS FENETRE	525792
76 RAL 7039 GRIS QUARTZ	525793
77 RAL 7040 GRIS AGATHE	525794
78 RAL 7042 GRIS TRAFIC	525795
79 RAL 7048 GRIS TAUPE	525796
80 RAL 8002 BRUN SIGNAL	525797
81 RAL 8003 BRUN CLAIR	525798

Désignation	Réf.
82 RAL 8004 BRUN CUIVRE	525799
83 RAL 8011 BRUN NOIX	525800
84 RAL 8012 BRUN ROUGE	525801
85 RAL 8014 BRUN SEPIA	525802
86 RAL 8016 BRUN ACAJOU	525803
87 RAL 8017 BRUN CHOCOLAT	525804
88 RAL 8019 BRUN GRIS	525805
89 RAL 8022 BRUN FONCE	525806
90 RAL 8023 BRUN ORANGE	525807
91 RAL 9001 BLANC CRÈME	525808
92 RAL 9002 BLANC GRIS	525809
93 RAL 9003 BLANC SIGNAL	525810
94 RAL 9005 NOIR BRILLANT	525811
95 RAL 9005 NOIR MAT	525812
96 RAL 9005 NOIR SATINE	525813
97 RAL 9006 ALUMINIUM	525814
98 RAL 9007 GRIS ALUMINIUM	525815
99 RAL 9010 BLANC MAT	525816
100 RAL 9010 BLANC BRILLANT	525817
101 RAL 9010 BLANC SATINE	525818
102 RAL 9016 BLANC TRAFIC	525819
103 TRANSPARENT BRILLANT	525820
104 TRANSPARENT OPAQUE	525821
105 RAL 9005 NOIR BRILLANT(AEROSOL 600ML)	525822
106 RAL 9005 NOIR MAT (AEROSOL 600ML)	525823
107 RAL 9010 BLANC MAT (AEROSOL 600ML)	525824
108 RAL 9010 BLANC BRILLANT (AEROSOL 600ML)	525825



/ BOMBE PEINTURE AMBRO-SOL AMOVIBLE - AEROSOL 400ML

Désignation	Réf.
1 NOIR MAT	525831
2 BLANC MAT	525832
3 ALU RAL 9006	525833
4 ROUGE RAL 3000	525834
5 BLEU RAL 5017	525835
6 VERT RAL 6029	525836
7 JAUNE RAL 1023	525837
8 TRANSPARENT	525838
9 TRANSPARENT BRILLANT	525839
10 OR	525840

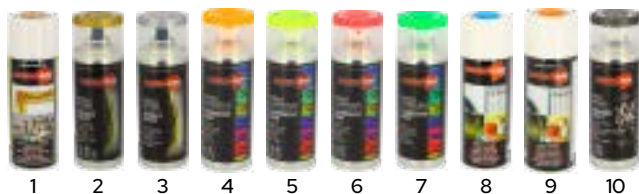

/ BOMBE PEINTURE AMBRO-SOL EFFET - AEROSOL 400ML

Désignation	Réf.
1 CUIVRE	525854
2 OR BRILLANT	525855
3 ARGENT	525856
4 FLUO ORANGE	525857
5 FLUO JAUNE	525858
6 FLUO FUCHSIA	525859
7 FLUO VERT	525860
8 FLUO BLEU	525861
9 FLUO ROUGE	525862
10 ACIER VINTAGE	525863
11 ACIER GRIS CLAIR	525864
12 ACIER FER FORGE GRIS	525865
13 ACIER ANTHRACITE	525866
14 ACIER NOIR GRAPHITE	525867
15 ACIER ARGENT	525868



/ BOMBE PEINTURE AMBRO-SOL HAUTE TEMPERATURE - AEROSOL 400ML

Désignation	Réf.
1 NOIR MAT	525841
2 ALUMINIUM	525842
3 ROUGE	525843
4 BLANC	525844
5 TRANSPARENT	525845
6 GRIS ANTHRACITE	525846
7 ROUGE FREINS	525847
8 NOIR BRILLANT	525848



/ BOMBE PEINTURE AMBRO-SOL SPECIAL TP / AGRI - AEROSOL 400ML

Désignation	Réf.
1 ORANGE KUBOTA	525952
2 GRIS LOXAM	525953
3 ROUGE MASSEY FERGUSSON	525954
4 VERT JOHN DEERE	525955
5 JAUNE JOHN DEERE	525956
6 JAUNE CATERPILLAR	525957
7 BLEU NEW HOLLAND	525958
8 JAUNE NEW HOLLAND	525959
9 VERT FENDT	525960
10 VERT CLASS	525961
11 VERT MERLO	525962
12 BLEU NISSAN / RENAULT	525963
13 JAUNE HAULOTTE	525964
14 ORANGE HITACHI	525965
15 ORANGE BOBCAT	525966
16 BLANC BOBCAT	525967
17 ROUGE LOXAM	525968



/ BOMBE PEINTURE AMBRO-SOL TRACAGE - DIFFUSEUR 360° / AEROSOL 500ML

Désignation	Réf.
1 JAUNE FLUO	525869
2 FUCHSIA FLUO	525870
3 ORANGE FLUO	525871
4 VERT FLUO	525872
5 BLEU FLUO	525873
6 ROUGE FLUO	525874
7 BLANC PASTEL	525875



/ BOMBE PEINTURE AMBRO-SOL FINITION / SPOILER - AEROSOL 400ML



Désignation	Réf.
1 GRIS CLAIR	525851
2 GRIS FONCE	525852
3 TRANSPARENT POUR CARROSSERIE	525853

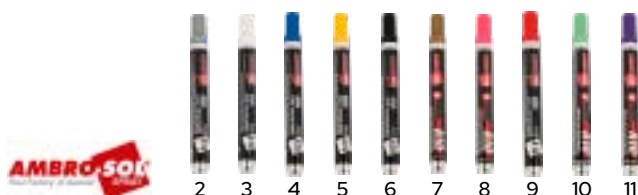

/ MARQUEUR AMBRO-SOL POINTE MOYENNE - 10ML

Désignation	Réf.	Désignation	Réf.
1 ORANGE	525878	7 OR	525884
2 ARGENT	525879	8 ROSE	525885
3 BLANC	525880	9 ROUGE	525886
4 BLEU	525881	10 VERT	525887
5 JAUNE	525882	11 VIOLET	525888
6 NOIR	525883		



/ BOMBE PEINTURE AMBRO-SOL PROTECTION BAS DE CAISSE - AEROSOL 400ML

Réf. 525850



/ PRIMER CARROSSERIE AMBRO-SOL - AEROSOL 400ML

Désignation	Réf.
GRIS	525827



/ PRIMER D'ACCROCHAGE AMBRO-SOL - AEROSOL 400ML



Désignation	Réf.
1 POUR METAL	525827
2 POUR PLASTIQUE	525828



/ BOMBE PEINTURE AMBRO-SOL ALUMINIUM POUR JANTES - AEROSOL 400ML

Réf. 525849



/ CRAYON / MARQUEUR PNEU PILOT BLANC

Réf. 169359



/ POIGNEE PISTOLET MOTIP POUR APPLICATION AEROSOL / PEINTURE

Réf. 490426





**/ VERIN SELLE MAXI SCOOTER TOP PERFORMANCE
ADAPT. YAMAHA 125 / 250 / 400 XMAX (2013->)**

Réf. 512108



**/ VERIN SELLE MAXI SCOOTER TOP PERFORMANCE
ADAPT. KYMCO 125 / 300 / 350 DOWNTOWN**

Réf. 515909



**/ VERIN SELLE MAXI SCOOTER TOP PERFORMANCE
ADAPT. YAMAHA TMAX 500 / 560 (2008-2017)**

Réf. 512107



**/ CABLE VERROUILLAGE SELLE MAXI SCOOTER OEM
XMAX / SKYCRUISER / EVOLIS 1SDF478E1000**

Réf. 510505



**/ SELLE MOTO ADAPT.
MASH 50 FIFTY /
125 CAFE RACER /
SEVENTY - NOIR**

Réf. 510990



/ CÂBLE COFFRE

Modèle	Cylindre	Année début	Année fin	Réf.
GILERA				
Runner ST 125 H2O 4T	125	2008	2013	521455
Runner VX 125 H2O 4T	125	1999	2007	521455
Runner VXR 180 H2O 4T	180	2002	2004	521455
Runner ST 200 H2O 4T	200	2008	2011	521455
Runner VXR 200 H2O 4T	200	2002	2006	521455
HONDA				
FORZA 300	300	2018	2021	521456
PIAGGIO				
X7 125 H2O 4T	125	2008	2008	521455
X7 Evo 125i H2O 4T	125	2009	2010	521455
X9 125	125	0	0	521457
X7 250i H2O 4T	250	2008	2008	521455
X9 250	250	0	0	521457
X7 Evo 300i H2O 4T	300	2009	2009	521455
X9 500	500	0	0	521457
VESPA				
Primavera 125 i AIR 4T 3V	125	2013	2017	521460
Primavera ABS 125 i IGET AIR 4T	125	2016	2020	521460
Sprint 125 i AIR 4T 3V	125	2014	2020	521460
Sprint ABS 125 i IGET AIR 4T	125	2016	2020	521460
Granturismo 125 L H2O 4T	125	2003	2006	521458
GTS 125 H2O 4T	125	2007	2012	521458
GTS ABS 125 i IGET H2O 4T 4V	125	2016	2018	521458
GTS ABS 125 i IGET H2O 4T 4V	125	2016	2019	521458
GTS Super 125 i H2O 4T	125	2009	2016	521458
GTS Super ABS 125 i H2O 4T	125	2014	2016	521458

Modèle	Cylindre	Année début	Année fin	Réf.
GTV 125 H2O 4T	125	2006	2008	521458
LXV 125 AIR 4T 2V	125	2006	2009	521459
LXV 125 i AIR 4T 2V	125	2010	2013	521459
LXV 125 i AIR 4T 3V	125	2013	2016	521459
Primavera 150 i AIR 4T	150	2013	2016	521460
Primavera ABS 150 i IGET AIR 4T	150	2016	2020	521460
Sprint 150 i AIR 4T 3V	150	2014	2018	521460
Sprint ABS 150 i IGET AIR 4T	150	2016	2020	521460
GTS ABS 150 i IGET H2O 4T 4V	150	2016	2018	521458
GTS Super ABS 150 i IGET H2O 4T 4V	150	2017	2020	521458
LXV 150 AIR 4T 2V	150	2007	2009	521459
LXV 150 i AIR 4T 2V	150	2011	2015	521459
LXV 150 i AIR 4T 3V	150	2013	2016	521459
Granturismo 200 L H2O 4T	200	2003	2008	521458
GTV 250 i H2O 4T	250	2006	2009	521458
GT60 250 i H2O 4T	250	2006	2007	521458
GTS 250 i H2O 4T	250	2005	2016	521458
GTS ABS 250 i H2O 4T	250	2005	2009	521458
GTV 300 i H2O 4T	300	2009	2013	521458
GTV 300 i H2O 4T	300	2017	2018	521458
GTS 300 i H2O 4T	300	2012	2013	521458
GTS ABS 300 i H2O 4T	300	2014	2018	521458
GTS Super 300 i H2O 4T	300	2008	2016	521458
GTS Super ABS 300 i H2O 4T	300	2014	2016	521458
GTS Super ABS 300 i HPE H2O 4T	300	2018	2020	521458
GTS Touring 300 i H2O 4T	300	2011	2012	521458



/ COMPTEUR MECABOITE KOSO DIGITAL DB EX-03 MULTIFONCTIONS

Compteur de vitesse

Plage d'affichage : 0 ~ 360 km / h (0 ~ 225 mph)
Unité d'affichage : km / h alternativement mph

Odomètre

Plage d'affichage : 0 ~ 99 999 km (miles), réinitialisation automatique après 99 999 km (miles)

Compteur journalier A, B

Unité d'affichage : 1 km (mile)
Plage d'affichage : 0,0 ~ 9 999,9 km (miles), réinitialisation automatique après 9 999,9 km (miles)

Compteur d'heures

Unité d'affichage : 0,1 km (mile)
Plage d'affichage : 0 ~ 99 999 heures
Unité d'affichage : 1 heure
Plage d'affichage : 0 à 9 999,9 heures, réinitialisation automatique après 9 999,9 heures

Unité d'affichage : 0,1 heure

Plage d'affichage : 00:00 ~ 23:59

Voltmètre

Plage d'affichage : 8,0 ~ 18,0 V CC
Unité d'affichage : 0,1 V CC

Chronomètre

Plage d'affichage : 8,0 ~ 18,0 V CC
Unité de réglage : 0,01 s.

Relevé du compteur kilométrique d'entretien

Plage de réglage : 300 ~ 5 000 km, peut être effacée manuellement
Unité de réglage : 1 km

MAX. Enregistrement

Vitesse moyenne : 0 à 360 km / h (0 à 225 mph)

Max. Vitesse : 0 à 360 km / h (0 à 225 mph)

Max. Tension : 8,0 ~ 18,0 V CC

Niveau de batterie interne : Plage d'affichage : 4 niveaux

Température de fonctionnement : -10 ~ +60°C

Taille du compteur : 120,0 x 38,8 x 34,2
spécification JIS D 0203 S2

Poids du compteur : Environ. 70g

Indicateurs lumineux :

Voyant droit (vert), Témoin d'huile moteur (rouge), Voyant de bas niveau de carburant (ambre), Voyant de température de l'eau (rouge), Voyant neutre (vert), Feu de route (bleu), Voyant gauche (vert), Voyant moteur (jaune)

Réf. 523536



/ COMPTE TOUR DIGITAL MULTIFONCTIONS

COMPTEUR MECABOITE KOSO DIGITAL DB EX-02
MULTIFONCTIONS (ADAPT MRT 2016-> / BETA RR 2016->)

Réf. 494437



/ AIMANT COMPTEUR KOSO (PETIT MODELE) X1

Réf. 481933



/ COMPTEUR MECABOITE KOSO DIGITAL DB-01RN MULTIFONCTIONS

- Compteur de vitesse
- Totaliseur kilométrique total et partiel
- Compte-tours
- Jauge essence
- Jauge température
- Sonde température
- Témoin huile
- Indication charge batterie
- Affichage: clignotant, feu de route, neutre
- Voyant point mort
- Compatible 2 temps et 4 temps

Réf. 477207



/ COMPTEUR MECABOITE KOSO DIGITAL XRSRN MULTIFONCTIONS

- Compteur de vitesse
- Totaliseur kilométrique total et partiel
- Compte-tours
- Jauge essence
- Sonde température
- Témoin huile
- Horloge
- Affichage: clignotant, warning, point mort, feu de route, feu de croisement
- Compatible 2 temps et 4 temps

Réf. 477146



/ COMPTEUR MECABOITE OEM RIEJU MRT 2009->2015 (0 / 001.000.2102)

Réf. 504107



/ COMPTE TOUR DIGITAL LCD

COMPTE TOURS POLINI ELECTRONIQUE DIGITAL LCD (15000TRS / MIN) - SANS SONDE LAMBDA -

Réf. 492994



/ COMPTE TOUR AIGUILLE

COMPTE TOURS KOSO AIGUILLE (0-16000 TOURS) + INDICATEUR DE TEMPERATURE

Réf. 477145



/ SONDE TEMPERATURE

THERMOMETRE / SONDE TEMPERATURE AMBIANT TUN'R DIGITAL MAX 93 DEGRE

Réf. 482498



/ DISQUE CAPTEUR

DISQUE CAPTEUR / PISTE ABS MAXI SCOOTER OEM 125 XMAX / SKYCRUISER / EVOLIS (1SD2517G00000)

Réf. 510509



/ DEMULTIPLIFICATEUR

DEMULTIPLIFICATEUR / ENTRAINEUR COMPTEUR MAXI SCOOTER TEKNIX ADAPT. 125-250-500 APRILIA / PIAGGI

Réf. 515133



/ DEMULTIPLIFICATEUR

DEMULTIPLIFICATEUR / ENTRAINEUR COMPTEUR MECABOITE TEKNIX ADAPT. DERBI GPR 04->10 / RS 06->10

Réf. 520705



/ DEMULTIPLIFICATEUR

DEMULTIPLIFICATEUR / ENTRAINEUR COMPTEUR SCOOTER / MAXI SCOOTER TEKNIX ADAPT. PIAGGIO (56147R)

Réf. 498524



/ DEMULTIPLIFICATEUR

DEMULTIPLIFICATEUR / ENTRAINEUR COMPTEUR SCOOTER OEM SYM ORBIT III / FIDDLE III / FIDDLE IV / E-XPRO

Réf. 510686



/ DEMULTIPLIFICATEUR

DEMULTIPLIFICATEUR / ENTRAINEUR COMPTEUR SCOOTER OEM SYM ORBIT / ORBIT II / SYMPPLY

Réf. 510587



/ COMPTEUR DIGITAL MULTIFONCTIONS (AVEC SUPPORT UNIVERSEL)

- Compteur de vitesse
- Totaliseur d'heure
- Décompte kilométrique périodicité entretien véhicule
- Indication charge batterie
- Indication jauge d'essence 6 niveaux
- Horloge 24h
- Passage de mh:h a km / h par une pression de 3 secondes sur le bouton adjust de l'écran principal
- Possibilité d'utiliser le voyant warning pour le témoin d'huile
- Réglage du rétro-éclairage à 5 niveaux
- Trip a et b
- Affichage: clignotant droit et gauche, plein phare, point mort

Réf. 492395



/ SUPPORT COMPTEUR



504147



518101



505222

Désignation	Réf.
SUPPORT COMPTEUR MECABOITE / MOTO OEM RIEJU MRT PRO 2015-> / 125 MARATHON PRO (0 / 000.980.5035F	504147
SUPPORT COMPTEUR MECABOITE / MOTO OEM RIEJU MRT PRO 2021-> / 125 MARATHON PRO (0 / 000.980.5034)	518101
SUPPORT COMPTEUR MECABOITE / MOTO OEM RIEJU MRT SAUF PRO / TROPHY / 125 MARATHON 2015->2021	505222



/ TRANSMISSION / CABLE COMPTEUR

Désignation	SYM	TEKNIX
MAXI SCOOTER SCOOTER OEM SYM MIO 50 / 100 CC (44830-T47-000)	520359	
MAXI SCOOTER TEKNIX ADAPT. 125 HONDA SH		490671
MAXI SCOOTER TEKNIX ADAPT. 125 KYMCO AGILITY 08-> / CYGNUS 97->0		490685
MAXI SCOOTER TEKNIX ADAPT. 125 KYMCO DINK 97->		490683
MAXI SCOOTER TEKNIX ADAPT. 125 KYMCO GRAND DINK 01->04		490684
MAXI SCOOTER TEKNIX ADAPT. 125 MAJESTY / SKYLINER		490674
MAXI SCOOTER TEKNIX ADAPT. 125 PIAGGIO LIBERTY 07->		490681
MAXI SCOOTER TEKNIX ADAPT. 125 PIAGGIO X7 08->		490679
MAXI SCOOTER TEKNIX ADAPT. 125 PIAGGIO X8 05-07 / FLY 05->		490680
MAXI SCOOTER TEKNIX ADAPT. 125 SUZUKI BURGMAN 02->06		490677
MAXI SCOOTER TEKNIX ADAPT. 125 SUZUKI BURGMAN 07->11		490678
MAXI SCOOTER TEKNIX ADAPT. 125 SYM HD EVO 05->		490676
MAXI SCOOTER TEKNIX ADAPT. 125 SYM JOYRIDE 03->08		490675
MAXI SCOOTER TEKNIX ADAPT. 125 VESPA GT / GTS 03->		490682
MAXI SCOOTER TEKNIX ADAPT. 125 YAMAHA CYGNUS / MBK FLAME 04->06		490673
SCOOTER / MAXI SCOOTER TEKNIX ADAPT. 50 / 125 KYMCO AGILITY / LIKE		482393
SCOOTER / MAXI SCOOTER TEKNIX ADAPT. 50 / 125 VESPA LX		490686

MOTEUR

CYCLE

PNEUMATIQUE

ATELIER

ACCESSOIRES

ÉLECTRICITÉ

FILTRATION

FREINAGE

TRANSMISSION

Modèle	Cylindre	Année début	Année fin	Réf.
APRILIA				
Leonardo 125	125	1996	2001	521535
Leonardo 125 ST	125	2002	2005	521535
Scarabeo 125	125	1999	2004	521535
Scarabeo 125 Touring	125	2000	2004	521535
RS 125 Replica H2O 2T	125	1999	2005	521540
Mojito 125	125	2003	2007	521536
Mojito 125	125	2003	2007	521536
Sport City One 125 AIR 4T	125	2008	2011	521546
SR Motard 125 AIR 4T	125	2012	2014	521546
Habana 125	125	1999	2001	521533
Mojito Retro 125	125	2003	2007	521533
Leonardo 150	150	1997	1999	521535
Arrecife 200	200	2004	2006	521535
Atlantic 200	200	2004	2005	521535
RS 250	250	1994	2004	521541
Pegaso 650	650	1997	2000	521537
Pegaso 650	650	2001	2004	521538
BMW				
R 24	250	1949	1949	521550
R 25	250	1951	1955	521550
R 26	250	1956	1959	521551
R 27	250	1961	1965	521551
R 50/5	500	1969	1973	521553
R 51	500	1951	1953	521554
R 50/2	500	1968	1970	521552
R 60	600	1977	1978	521555
R 65	600	1974	1976	521555
R 67	600	1951	1955	521554
R 68	600	1952	1954	521554
R 60/2	600	1967	1970	521552
R 69 S	600	1967	1970	521552
R 65	650	1979	1987	521555
R 65 LS	650	1981	1985	521555
F 650	650	1997	2000	521547
F 650 ST	650	1997	1997	521547
F 650 CS	650	2002	2005	521548
R 75	750	1977	1977	521555
R 75/6	750	1974	1976	521555
R 80/7	800	1978	1980	521555
R 80	800	1980	1988	521555
R 850 R ABS (ROUE BATON)	850	1998	2002	521556
R 850 R ABS	850	1998	2002	521556
R 850 R ABS S (ROUE RAYON)	850	1998	2002	521556

Modèle	Cylindre	Année début	Année fin	Réf.
R 850 R ABS (ROUE RAYON)	850	1998	2002	521556
R 850 R (ROUE BATON)	850	1997	2002	521556
R 850 R	850	1997	2000	521556
R 90/6	900	1974	1976	521555
R 90 S	900	1974	1976	521555
R 90/S	900	1973	1976	521553
R 100/7 T	1000	1977	1978	521555
R 100 CS	1000	1981	1981	521555
R 100 GS	1000	1988	1990	521555
R 100 R	1000	1992	1994	521555
R 100 R Mystik	1000	1994	1995	521555
R 100 RS	1000	1977	1977	521555
R 100 RS	1000	1979	1984	521555
R 100 RS	1000	1988	1988	521555
R 100 RS	1000	1992	1992	521555
R 100 RT	1000	1978	1984	521555
R 100 RT	1000	1988	1996	521555
R 100 RT	1000	1988	1996	521555
R 100 S	1000	1977	1980	521555
R 100 T	1000	1979	1984	521555
R 100 GS	1000	1991	1995	521549
R 100 GS Paris-Dakar	1000	1989	1996	521549
CAGIVA				
Mito 125	125	0	0	521557
DERBI				
Variant Sport 125 AIR 4T	125	2012	2012	521546
Cross City 125 AIR 4T	125	2007	2012	521563
DUCATI				
Monster 400	400	2000	2003	521567
Monster 600	600	2001	2001	521567
Monster 750	750	2001	2001	521567
Monster 900 S i.e.	900	2001	2001	521567
Monster S4	916	2001	2001	521567
GILERA				
Runner FX 125 H2O 2T	125	1998	2002	521570
Runner FX 125 H2O 2T	125	1998	2002	521571
Runner FXR 180 H2O 2T	180	1998	2002	521570
Runner FXR 180 H2O 2T	180	1998	2002	521571
HONDA				
XL 125 R	125	1984	1985	521641
XL 125 S	125	1982	1983	521641
XL 125	125	1976	1976	521640
XL 125 S	125	1979	1981	521640
CBF125	125	2011	2011	521598

Modèle	Cylindre	Année début	Année fin	Réf.
CA 125 Rebel	125	1995	2000	521579
CA 125 Rebel 80 Km/h	125	1995	2000	521579
SL 125 S	125	1976	1977	521626
TL 125 S	125	1976	1977	521626
CB 125 T Twin	125	1980	1986	521583
FES Pantheon 2T 125	125	1998	2002	521610
Activa S 125	125	2017	2019	521575
CG 125 Brasil	125	1992	2002	521605
XR 125	125	2003	2008	521648
MTX 125 RW	125	1983	1985	521616
CG 125	125	1999	1999	521604
CG 125 TITAN	125	2000	2003	521604
PES 125	125	2006	2009	521623
PSI 125	125	0	0	521623
CB 125 F	125	2015	2020	521580
CBR 125 R	125	0	0	521600
CB 125 K	125	1972	1976	521581
CB 125 T	125	1978	1979	521582
CBF 125	125	0	0	521595
CG 125	125	1998	1998	521603
CBF 150	150	2016	2016	521596
FES Pantheon 2T 150	150	1998	2002	521610
CB 175	175	1969	1973	521584
CB 200 T	175	1976	1976	521584
CL 175 SC	175	1969	1973	521584
CL 200 SC	175	1974	1974	521584
XL 185 S	185	1979	1984	521641
XR 185	185	1979	1979	521649
XL 185 S	185	1979	1981	521640
CM 185 T	185	1978	1984	521582
MTX 200 RW	200	1983	1983	521616
PES 200	200	0	0	521623
PSI 200	200	0	0	521623
CM 200 T	200	1978	1985	521582
XR 200 R	200	1981	1983	521650
MT 250 ELSINORE	250	1976	1976	521649
NSS 250 A Jazz ABS	250	2001	2004	521579
NSS 250 Jazz	250	2001	2001	521579
XL 250 R	250	1982	1987	521640
MR 250	250	1976	1976	521640
CMX 250 C Rebel	250	1996	1999	521579
CN 250 Helix	250	1986	1990	521579
CN 250 Helix Spazio	250	1991	1999	521579
NX 250	250	1988	1995	521617
NX 250 A	250	1988	1990	521618

Modèle	Cylindre	Année début	Année fin	Réf.
FES Foresight 250	250	1998	2005	521610
CB 250	250	1992	1997	521585
CBF 250	250	2004	2006	521597
XL 250 S	250	1981	1982	521644
XL 250 S	250	1981	1982	521642
CL 250 SC	250	1981	1984	521606
CB 250 G	250	1974	1977	521586
CB 250 K	250	1969	1973	521581
XL 250 S	250	1981	1982	521643
XR 250	250	1979	1980	521651
XL 350	350	1977	1978	521645
CB 350 K	350	1969	1973	521581
CB 360 T	360	1979	1979	521587
CB 360 T	360	1976	1976	521649
CJ 360 T	360	1976	1977	521649
CB 360 G5	360	1974	1977	521586
CB 360 G5	360	1973	1976	521581
CB 400 F	400	1976	1977	521649
CB 400 A	400	1978	1978	521649
CB 400 TI	400	1978	1979	521649
CB 400 TII	400	1978	1979	521649
NS 400 R	400	1985	1986	521579
CBR 400 RR	400	1988	1999	521601
CBR 400 R	400	1986	1987	521601
CM 400 T	400	1979	1981	521645
CM 400 A	400	1979	1980	521645
CM 400 C	400	1981	1981	521645
CB 400 T	400	1980	1981	521645
VFR 400 R3	400	1991	1993	521617
RVF 400 NC 35	400	0	0	521624
CB 400	400	0	0	521588
CM 450 A	450	1982	1982	521607
CM 450 C	450	1982	1982	521607
CB 450 T	450	1981	1982	521645
CMX 450 C Rebel	450	1986	1987	521579
CB 450 K0 K1 K2	450	1965	1969	521589
CB 450 K1/K2	450	1968	1969	521590
CB 450 S	450	1986	1989	521591
CX 500 A	500	1978	1979	521587
CB 500 T	500	1976	1976	521649
CX 500	500	1978	1979	521649
CX 500 C	500	1979	1979	521649
CX 500 D	500	1979	1979	521649
GL 500 SILVER WING	500	1981	1981	521607
GL 500 I SILVER WING	500	1981	1981	521607

Modèle	Cylindre	Année début	Année fin	Réf.
GB 500 Clubman	500	1989	1990	521579
XBR 500 (ROUE BATON)	500	1985	1987	521579
XBR 500 S (ROUE RAYON)	500	1987	1989	521579
VF 500 F Interceptor	500	1984	1987	521629
CX 500 D	500	1980	1980	521645
CX 500 C	500	1980	1980	521645
CX 500 E Euro Sports	500	1982	1986	521579
CX 500 TC Turbo	500	1982	1982	521609
VT 500 C Shadow	500	1983	1984	521634
XL 500 S	500	1981	1982	521644
XL 500 S	500	1981	1982	521642
CB 500	500	1994	1995	521592
CB 500	500	1998	1999	521591
CB 500 S Sport	500	1998	2003	521591
XL 500 S	500	1981	1982	521643
XR 500	500	1979	1980	521651
VT 500 E	500	1983	1985	521635
CX 500 TC Turbo	500	1982	1982	521608
XL 500 R	500	1982	1982	521650
CB 550 F SUPER SPORT	550	1976	1977	521587
CB 550 F	550	1976	1977	521649
CB 550 K	550	1976	1978	521649
VT 600 C Shadow	600	1989	2000	521636
VT 600 C Shadow Pinion coarsely toothed	600	1988	1988	521636
VT 600 C Shadow Pinion fine-toothed	600	1988	1988	521636
XL 600 V Transalp	600	1997	2000	521591
CB 600 Hornet F	600	1998	2006	521593
XL 600 V Transalp	600	1989	1990	521646
CBR 600 F	600	1987	1994	521591
CB 600	600	0	0	521588
XR 600 R	600	1993	2000	521650
CX 650 E Euro	650	1983	1983	521579
NTV 650 Revere	650	1988	1997	521579
CB 650 C	650	1980	1980	521645
CB 650	650	1979	1979	521645
CBX 650 E	650	1983	1984	521602
GL 650 D Silverwing	650	1983	1983	521636
NT 650 V Deauville	650	1998	2001	521636
NT 650 V Deauville CBS	650	2002	2005	521636
CB 650 C Custom	650	1980	1981	521594
XL 650 V Transalp	650	2000	2007	521591
CX 650 T Turbo	650	1983	1985	521609
XL 650 TRANSALP	650	1997	2007	521647

Modèle	Cylindre	Année début	Année fin	Réf.
NX 650 A	650	1988	1989	521619
NX 650 AC	650	1988	1989	521619
NX 650 Dominator	650	1996	2000	521621
CX 650 C Custom	650	1983	1983	521634
XR 650 L	650	1993	1994	521652
FX 650	650	0	0	521588
NX 650	650	0	0	521588
SLR 650	650	0	0	521588
NX 650 Dominator	650	1988	1992	521620
CB 650	650	1980	1982	521594
CB 650 SC	650	1982	1982	521651
CB 900 C	650	1981	1982	521651
CX 650 T Turbo	650	1983	1985	521608
XR 650 R	650	2000	2007	521650
VT 700 C	700	1984	1985	521637
CB 750 F SUPER SPORT	750	1977	1978	521649
CB 750 K FOUR	750	1979	1982	521649
CB 750 L	750	1979	1979	521649
CB 750 F SUPER SPORT	750	1976	1976	521607
CB 750 A	750	1976	1978	521607
CB 750 K	750	1976	1978	521607
VF 750 C Magna	750	1993	2000	521579
VFR 750 F	750	1986	1989	521579
XRV 750 Africa Twin	750	1990	2003	521579
VF 750 C Magna	750	1982	1984	521630
CB 750 F SUPER SPORT	750	1979	1980	521645
VF 750 Interceptor F	750	1983	1985	521631
VT 750 Shadow C	750	1987	1988	521631
CB 750 F2 Seven Fifty	750	1992	2003	521579
CB 750 Nighthawk	750	1991	1992	521579
VFR 750 F	750	1990	1993	521632
CBX 750 F	750	1984	1986	521636
CB 750 K Four	750	1969	1978	521594
XRV 750 Africa Twin	750	1990	1995	521653
VFR 750 F	750	1990	1993	521633
CB 750 C Custom	750	1981	1983	521586
CB 750 F	750	1980	1982	521586
CB 750 F2	750	1982	1982	521586
CB 750 K	750	1979	1982	521586
VT 750 C	750	1983	1985	521637
VT 800 C	800	1988	1988	521638
CB 900 F SUPER SPORT	900	1981	1982	521645
CBR 900 RR	900	1994	1994	521591
GL 1000 SILVER WING	1000	1979	1979	521607
VF 1000 F Interceptor	1000	1984	1985	521602

Modèle	Cylindre	Année début	Année fin	Réf.
VF 1000 F2 Bol d'Or	1000	1985	1985	521602
VF 1000 F	1000	1984	1985	521631
VF 1000 Interceptor F	1000	1984	1984	521631
CBR 1000 F	1000	1987	1988	521599
GL 1000 Goldwing	1000	1976	1977	521611
GL 1000 Goldwing Ltd	1000	1976	1976	521611
CBR 1000 F	1000	1990	1991	521652
GL 1100 GOLD WING	1100	1980	1982	521649
GL 1100 I GOLD WING	1100	1980	1982	521649
GL 1100 A GOLD WING	1100	1982	1982	521649
ST 1100 A Pan European ABS	1100	1992	1995	521579
ST 1100 Pan European	1100	1990	2001	521579
VT 1100 C Shadow	1100	1988	1995	521634
GL 1200 D Goldwing	1200	1984	1987	521612
GL 1500 Goldwing	1500	1988	1990	521602
GL 1500 SE Goldwing	1500	1991	2000	521602
HYOSUNG				
GP 125	125	0	0	521655
GT 125	125	0	0	521656
GF 125	125	0	0	521654
RT 125	125	0	0	521657
RX 125	125	0	0	521658
KAWASAKI				
KMX 125 B	125	1991	2003	521681
BN 125 A Eliminator	125	1998	1999	521661
KDX 125	125	1990	1994	521675
KH 250 B	250	1976	1980	521676
Z 250 A	250	1979	1980	521692
EL 250 B Eliminator	250	1988	1989	521662
Ninja 250 R	250	1986	2007	521688
EX 250 R NINJA	250	2004	2008	521666
KZ 305 LTD	305	1987	1988	521683
KZ 305 CSR	305	1981	1982	521683
GPZ 305	305	0	0	521668
Z 305 GP	305	0	0	521668
GPZ 305	305	1983	1983	521669
S2 350 A Mach 2	350	1973	1973	521676
S2 350 Mach 2	350	1972	1972	521676
KH 400 A	400	1976	1978	521676
Z 400 D	400	1974	1977	521692
Z 400 B	400	1978	1980	521692
S3 400 A Mach 2	400	1975	1975	521676
S3 400 Mach 2	400	1974	1974	521676
GPZ 400 A	400	1985	1985	521670

Modèle	Cylindre	Année début	Année fin	Réf.
Z 400 G Custom	400	1979	1979	521693
Z 440 C	440	1980	1980	521693
EN 450 A Ltd	450	1985	1989	521663
ER 500	500	1999	2002	521665
KLE 500 A	500	2001	2004	521661
KLE 500 B	500	2005	2007	521661
HI 500 A Mach 3	500	1971	1971	521672
HI 500 B	500	1972	1972	521672
HI 500 D	500	1973	1973	521672
HI 500 E	500	1974	1974	521672
HI 500 F	500	1975	1975	521672
HI 500 Mach 3	500	1969	1970	521672
KH 500 A	500	1976	1977	521672
HI 500 Mach III	500	1969	1969	521673
KH 500 A	500	1976	1976	521673
HI 500	500	1970	1975	521673
EX 500	500	1987	1989	521662
Ninja 500 R	500	1996	2009	521688
Ninja 500	500	1994	1996	521688
EX-500	500	1990	1993	521667
KLE 500	500	0	0	521668
EN 500 VULCAN LTD	500	1996	2009	521664
EN 500 A	500	1990	1993	521663
KZ 550	550	1980	1983	521684
Z 550 C Ltd	550	1980	1982	521694
GPZ 550	550	1981	1983	521683
KZ 550	550	1980	1983	521683
GPZ 550 A Uni Trak	550	1984	1989	521670
ZL 600 Eliminator	600	1996	1997	521665
KLR 600 A	600	1984	1984	521681
KLR 600 B	600	1985	1989	521681
GPZ 600 R	600	0	0	521668
ZZR 600	600	2003	2005	521699
600 RX Ninja	600	1987	1987	521699
Ninja ZX-6	600	1990	1992	521669
ZX-6 Ninja	600	1993	2002	521699
600 R Ninja	600	1990	1997	521699
600 Ninja	600	1985	1987	521699
KZ 650 LTD	650	1980	1980	521685
KLR 650 A	650	1987	1987	521678
KZ650	650	1978	1979	521687
KLX 650 C	650	1993	1995	521679
KZ 650	650	1980	1980	521683
KLR 650	650	1996	2007	521677
Z 650 B	650	1977	1977	521695

Modèle	Cylindre	Année début	Année fin	Réf.
KLX 650 R	650	1993	1995	521680
KLX 650 R	650	1999	2001	521680
Z 650 SR	650	1979	1979	521693
Z 650 B	650	1978	1980	521693
Z 650 B	650	1977	1977	521696
Z 650 C	650	1978	1980	521693
KZ 700	700	1984	1984	521683
ZR 750	750	2000	2003	521665
KZ 750	750	1980	1982	521685
ZXR 750 J	750	1991	1992	521661
ZXR 750 L	750	1993	1995	521661
ZXR 750 R	750	1991	1995	521661
GPX 750 R	750	1987	1988	521661
VN 750 A	750	1986	1995	521694
Z 750 H Ltd 4 cylinders	750	1980	1982	521694
Z 750 K Ltd Twin belt drive	750	1983	1984	521694
Z 750 Y Ltd Twin	750	1982	1983	521694
KZ 750	750	1980	1983	521683
KZ 750 LTD	750	1980	1980	521683
GPZ 750	750	1980	1982	521683
H2	750	1972	1975	521674
GPZ 750 A Uni Trak	750	1985	1985	521670
ZX 750 E Turbo	750	1984	1985	521670
Z 750 B Twin	750	1976	1977	521695
Z 750 B Twin	750	1978	1978	521693
Z 750 B Twin	750	1976	1977	521696
ZX-7RR	750	1996	1997	521667
ZX-7R	750	1996	2003	521667
ZX-7	750	1989	1990	521667
GPz 750 - ZX750-A2 Cables	750	1984	1984	521671
GPz 750 - ZX750-A1 Cables	750	1983	1983	521671
VN 800 Drifter	800	0	0	521690
VN 800 VULCAN	800	1998	1998	521691
VN 800 A	800	1995	1999	521689
VN 800 B Classic	800	1996	2006	521689
ZX 900 Ninja	900	1984	1986	521685
ZX-9R 900 B Ninja	900	1994	1997	521661
KZ 900	900	1976	1976	521686
Z 900 A	900	1976	1976	521695
ZI 900	900	1973	1973	521695
ZIA 900	900	1974	1974	521695
ZIB 900	900	1975	1975	521695
Z 900 A	900	1976	1976	521696
ZIA 900	900	1974	1974	521696
ZIB 900	900	1975	1975	521696

Modèle	Cylindre	Année début	Année fin	Réf.
ZX 10 Ninja	1000	1988	1990	521698
KZ 1000	1000	1981	1983	521685
KZ 1000	1000	1977	1980	521686
Z 1000 A	1000	1977	1977	521695
ZIR 1000 D	1000	1978	1978	521695
Z 1000 A	1000	1977	1977	521696
Z 1000 A	1000	1978	1979	521693
ZI 900	1000	1973	1973	521696
Z 1000 MK2	1000	1979	1980	521693
ZIR 1000 D	1000	1978	1978	521696
ZG 1000	1000	1986	2006	521697
ZX 1000 R	1000	1986	1987	521697
ZZR 1100 G catalyst	1100	1998	2001	521661
GPZ 1100 B	1100	1981	1982	521685
Z 1100 ST	1100	1981	1983	521694
ZR 1100 Zephyr	1100	1992	1995	521683
GPZ 1100 A Uni Trak	1100	1983	1985	521670
GPz - ZX1100-A1 Cables	1100	1983	1983	521671
GPz - ZX1100-A2 Cables	1100	1984	1984	521671
KZ 1300 A	1300	1979	1982	521682
KZ 1300 B	1300	1980	1980	521682
VN 1500 Vulcan	1500	1988	1999	521665
VN 1500 L Vulcan	1500	1996	1997	521665
VN 1500 D Classic	1500	1996	1997	521678
VN 1500 F Classic	1500	1998	1999	521678

KEEWAY				
F-Act 125	125	2010	2013	521700
Focus 125	125	2006	2007	521700
Matrix 125	125	2006	2009	521700
Speed 125	125	2006	2012	521701
Superlight 125	125	0	0	521702
Superlight 150	150	0	0	521702

KTM				
DUKE II 640	640	1999	2006	521703

KYMCO				
Like 125 II i CBS euro4	125	2017	2019	521708
Like 125 II i Exclusive ABS euro4	125	2019	2020	521708
Like 125 LX	125	2014	2015	521708
Agility 125 R12	125	2006	2007	521708
Agility 125 R12	125	2012	2016	521708
Agility 125 R12 Carry	125	2015	2017	521708
Agility 125 R12 i Carry CBS	125	2017	2019	521708
Agility 125 R12 MMC	125	2008	2011	521708
Dink 125 Bet & Win	125	2000	2006	521708

Modèle	Cylindre	Année début	Année fin	Réf.
Like 125	125	2009	2017	521708
Agility Plus 125 cc	125	2014	2016	521704
Agility R16 125 cc	125	2008	2012	521704
People S 125 cc	125	2005	2008	521704
Super 8 125 cc	125	2008	2009	521704
Dink 125	125	1997	1998	521706
Dink LX 125	125	1998	2000	521706
Dink Classic 125	125	2002	2003	521706
People 125	125	1999	2003	521709
People 125	125	2007	2011	521709
CK 125	125	0	0	521705
Yager 125 I2 «»	125	2002	2006	521711
Yager/Spacer 125 I0 «»	125	1998	2004	521711
Grand Dink 125	125	2001	2008	521707
Agility R16 150 cc	150	2008	2009	521704
Dink 150	150	1997	1998	521706
Dink LX 150	150	1998	2000	521706
People 150	150	1999	2003	521709
Grand Dink 150	150	2001	2004	521707
Dink Classic 150	150	2002	2003	521706
Like 200 i	200	2010	2017	521708
Like 200 LX i	200	2015	2015	521708
Agility i Plus 200 cc	200	2014	2018	521704
Agility i R16 200 cc	200	2010	2014	521704
People S 200 cc	200	2005	2006	521704
People S ie 200 cc	200	2007	2007	521704
Dink Classic 200	200	2004	2004	521706
Dink 250 Bet & Win	250	2000	2004	521708
VENOX 250	250	2002	2007	521710
Grand Dink 250	250	2001	2006	521707

MALAGUTI

Madison 125	125	1999	2001	521718
Madison R 125 Restyling	125	2002	2004	521718
Ciak 125	125	2000	2002	521713
Ciak Master 125	125	2004	2004	521713
Ciak Restyling 125	125	2003	2003	521713
Ciak 125	125	2006	2006	521713
Madison T 150	150	1999	2001	521718
Ciak 150	150	2000	2002	521713
Ciak Master 150	150	2004	2004	521713
Ciak Restyling 150	150	2003	2003	521713
Ciak 200	200	2006	2006	521713

MBK

YP Skyliner 125	125	1998	2000	521721
-----------------	-----	------	------	--------

Modèle	Cylindre	Année début	Année fin	Réf.
YP Skyliner 150	150	1998	2000	521721
PEUGEOT				
Tweet 125i AIR 4T	125	2018	2020	521724
Tweet EVO 125 AIR 4T	125	2014	2017	521724
Tweet 125 AIR 4T	125	2010	2013	521724
Tweet 150 AIR 4T	150	2010	2013	521724
Tweet 150i AIR 4T	150	2018	2020	521724
Tweet EVO 150 AIR 4T	150	2014	2017	521724
PIAGGIO				
Liberty 125 cc	125	1998	2003	521732
Liberty 125 4T	125	2006	2012	486238
Liberty 125 4T 3V	125	2013	2014	486238
BEVERLY 125	125	2005	2006	521725
BEVERLY 125	125	2007	2008	521725
BEVERLY 125 RST	125	2004	2006	521725
BEVERLY 125 RST (2)	125	2005	2006	521725
BEVERLY 125 SPORT	125	2007	2008	521725
BEVERLY 125 TOURER	125	2007	2010	521725
Liberty 125 cc	125	2006	2008	521731
Liberty PTT 125	125	2007	2012	521731
Liberty RST PTT 125 cc	125	2005	2011	521731
Fly II DT 125i AIR 4T 3V	125	2013	2015	521730
Fly II LEM 125i AIR 4T 3V	125	2012	2014	521730
X8 125 H2O 4T	125	2004	2007	521736
X8 Street 125 AIR 4T	125	2006	2008	521736
Typhoon II 125 AIR 4T 2V	125	2010	2019	521546
Carnaby 125 H2O 4T	125	2007	2010	521728
X7 125	125	2001	0	521735
Beverly Sport RST 125 H2O 4T	125	2004	2008	521726
Beverly Tourer 125 H2O 4T	125	2007	2010	521726
Liberty 150 MOC	150	2009	2013	486238
Liberty 150 cc	150	2000	2003	521732
Liberty 150 4T 3V	150	2013	2014	486238
Liberty 150 cc	150	2008	2008	521731
Fly II 150i AIR 4T 3V	150	2013	2018	521730
X8 Street 150 AIR 4T	150	2006	2008	521736
Liberty 200 4T Sport	200	2006	2007	486238
Liberty 200 cc	200	2006	2008	521731
Liberty 200 4T	200	2006	2013	486238
X8 200 H2O 4T	200	2004	2007	521736
Carnaby 200 H2O 4T	200	2007	2008	521728
BEVERLY 250	250	2005	2005	521725
BEVERLY 250	250	2007	2007	521725
BEVERLY 250 IE	250	2006	2008	521725

Modèle	Cylindre	Année début	Année fin	Réf.
BEVERLY 250 IE SPORT	250	2006	2008	521725
BEVERLY 250 RST	250	2004	2006	521725
BEVERLY 250 RST (2)	250	2005	2005	521725
BEVERLY 250 TOURER	250	2007	2009	521725
BV 250 (USA)	250	2006	2008	521725
X8 250i H2O 4T	250	2005	2008	521736
Carnaby 250i H2O 4T	250	2008	2009	521728
Beverly Sport 250 H2O 4T	250	2004	2006	521726
Beverly Sport RST 250i H2O 4T	250	2006	2008	521726
Beverly Tourer 250i H2O 4T	250	2007	2009	521726
Carnaby Cruiser 300i H2O 4T	300	2009	2011	521729
X7 300 EVO	300	2009	2010	521735
Beverly Tourer 400i H2O 4T	400	2008	2009	521727
BEVERLY 400 IE	400	2006	2007	521725
X8 400i H2O 4T	400	2006	2008	521736
Beverly Sport RST 400i H2O 4T	400	2006	2007	521726
Beverly Tourer 500i H2O 4T	500	2007	2008	521727
SKY				
Team ST50-3 SM 50 4T Supermoto	125	2011	2016	521701
SUZUKI				
TS 125 ER	125	1970	1985	521779
TS 125	125	1970	1985	521779
TS 125 X	125	1988	1989	521779
TS-X 125	125	1990	1994	521779
UH 125 Burgman	125	2002	2006	521784
TS 125	125	1973	1977	521778
Marauder GZ125	125	2002	2011	521770
UH 125 Burgman	125	2007	2013	521785
UH 125 G Burgman	125	2008	2013	521785
GT 125	125	1974	1977	521767
GN 125	125	1994	1999	521747
TU 125 XT	125	1999	2001	521747
UC 125 Epicuro	125	1999	2002	521783
UC 125 U Epicuro 80 Km/h	125	1999	2000	521783
RG 125	125	1985	1988	521773
GN 125 E	125	1993	1993	521748
GN 125 E	125	1995	1995	521748
GN 125 ET	125	1991	1996	521748
GN 125 EV	125	1997	1997	521748
RV 125 VanVan	125	2002	2009	521774
SP 125	125	1982	1983	521776
AN 125	125	1995	1999	521741
UH 150 Burgman	150	2004	2006	521784

Modèle	Cylindre	Année début	Année fin	Réf.
GT 185	185	1973	1978	521767
GT 185 Adventurer	185	1973	1977	521768
TS 185 Sierra	185	1980	1981	521776
SP 200	200	1986	1988	521777
VanVan 200	200	2017	2019	521774
UH 200 Burgman	200	2007	2013	521785
UH 200 G Burgman	200	2008	2011	521785
TS 250 Savage	250	1969	1970	521780
GN 250	250	1985	1999	521749
GNX 250 E	250	1982	1984	521749
SP 250	250	1985	1985	521777
DR 250 SE	250	1990	1995	521745
DR-Z 250	250	2001	2007	521745
RMX 250 T	250	1989	1996	521745
RMX 250 W	250	1997	1998	521745
GSX 250 E	250	1982	1983	521758
DR 250 S	250	1985	1987	521744
GSX 250 E	250	1980	1981	521747
GZ 250 Marauder	250	1999	2008	521747
TS 250 Savage	250	1972	1979	521781
GT 250 Hustler	250	1973	1977	521768
TS 250 Savage	250	1972	1979	521768
SP 250	250	1982	1983	521776
DR 350 SE	350	1990	1999	521745
DR 350 SH	350	1992	1994	521744
DR 350	350	1990	1995	521744
DR 350 S	350	1990	1994	521744
GT 380	380	1972	1980	521769
GSX 400 E	400	1982	1987	521758
GSX 400 FE Katana	400	1981	1983	521758
GSF 400 Bandit	400	1992	1995	521753
GS 400 E	400	1977	1983	521747
GSX 400 S	400	1980	1981	521747
GSX 400 L	400	1980	1983	521747
TS 400 Apache	400	1972	1977	521768
GS 400 X	400	1997	1998	521748
GS 425 E	425	1979	1979	521748
GS 450 GA	450	1983	1983	521780
GS 450 T	450	1982	1982	521780
GS 450 TX	450	1981	1982	521780
GS 450 E	450	1983	1983	521780
GS 450 E (ROUE BATON)	450	1988	1988	521758
GS 450 EU (ROUE BATON)	450	1988	1988	521758
GS 450 L	450	1985	1987	521758
GS 450 S	450	1988	1988	521758

Modèle	Cylindre	Année début	Année fin	Réf.
GS 450 SU	450	1988	1988	521758
GS 450 TU	450	1981	1983	521758
GS 450	450	1985	1988	521750
GS 450 T	450	1983	1983	521750
T 500 R	500	1972	1975	521780
T 500 L	500	1971	1975	521780
T 500 K	500	1971	1974	521780
T 500 J	500	1971	1975	521780
T 500 M	500	1968	1975	521780
GS 500 E	500	1979	1979	521758
RG 500 Gamma	500	1986	1986	521772
RG 500 C Gamma	500	1987	1989	521772
GS 550 E	550	1977	1979	521780
GS 550 M	550	1982	1982	521780
GS 550 T	550	1981	1981	521780
GS 550 L (ROUE BATON)	550	1980	1980	521751
GSX 550 E (modèle F)	550	1985	1986	521743
GSX 550 EU (modèle F)	550	1985	1987	521743
GS 550 E (ROUE BATON)	550	1978	1979	521758
GS 550 M Katana	550	1981	1983	521758
GS 550 M Katana	550	1982	1983	521758
GS 550 (ROUE RAYON)	550	1977	1979	521758
GS 550 T (ROUE BATON)	550	1981	1981	521758
GT 550 2T	550	1973	1977	521769
VS 600 GL Intruder	600	1995	1997	521786
VS 600 GLU Intruder	600	1995	1997	521786
GSX 600 FU2	600	1988	1997	521759
VS 600 GL Intruder	600	1995	1997	521787
VS 600 GLU Intruder	600	1995	1997	521787
GSF 600 Bandit	600	1995	1999	521754
GSF 600 S Bandit	600	1996	1999	521754
GSF 600 SU Bandit	600	1996	1999	521754
GSF 600 U Bandit	600	1995	1999	521754
GSX 600 F	600	1988	1997	521759
GSX 600 FU	600	1988	1997	521759
RF 600 R	600	1993	1996	521771
RF 600 RU	600	1993	1996	521771
GSF 600 N Bandit	600	1998	1999	521755
DR 600 R Dakar	600	1986	1986	521741
DR 600 S	600	1985	1989	521741
DR 600 SU	600	1985	1989	521741
GS 650	650	1981	1983	521780
DR 650 RS	650	1990	1991	521746
DR 650 RSE	650	1991	1996	521746
DR 650 RSEU	650	1991	1996	521746

Modèle	Cylindre	Année début	Année fin	Réf.
DR 650 SE	650	1992	1995	521745
DR 650 S	650	1993	1993	521745
GR 650 (ROUE BATON)	650	1983	1989	521743
GR 650 X (ROUE RAYON)	650	1983	1989	521743
GS 650 G Katana	650	1981	1982	521758
GS 650 G Katana	650	1982	1982	521758
GS 750	750	1977	1979	521780
GSX 750 E (ROUE BATON)	750	1981	1981	521749
VS 750 GLF Intruder guidont plat	750	1986	1989	521786
VS 750 GLP Intruder guidont haut	750	1986	1991	521786
GSX 750 L	750	1980	1981	521749
GSX 750 (ROUE RAYON)	750	1981	1981	521749
GSX 750 F	750	1989	1997	521759
GSX-R 750	750	1988	1990	521759
GSX-R 750 W	750	1992	1995	521759
GSX 750 S Katana	750	1982	1984	521762
VS 750 GLF Intruder guidont plat	750	1986	1989	521787
VS 750 GLP Intruder guidont haut	750	1986	1991	521787
GS 750 L	750	1979	1979	521751
GSX 750 E (ROUE BATON)	750	1980	1980	521751
GSX 750 (ROUE RAYON)	750	1980	1980	521751
GS 750 D (ROUE RAYON)	750	1977	1979	521758
GS 750 E (ROUE BATON)	750	1978	1979	521758
GS 750 (ROUE RAYON)	750	1977	1979	521758
GSX 750 EF carenée	750	1984	1986	521761
GSX 750 ES semie-carenée	750	1983	1986	521761
GSX-R 750	750	1985	1987	521763
GSX-R 750 X	750	1986	1987	521763
GSX-R 750 R Special Edition	750	1986	1986	521763
GSX-R 750 RW	750	1993	1993	521766
GSX-R 750	750	1991	1991	521765
GSX-R 750	750	1985	1987	521764
GSX-R 750 X	750	1986	1987	521764
GSX-R 750 R Special Edition	750	1986	1986	521764
GSX 750	750	1998	2003	521760
GT 750 Lemans	750	1973	1977	521768
GT 550 Indy	750	1973	1977	521768
VS 800 GL Intruder	800	1992	2000	521786
VS 800 GL Intruder	800	1992	2000	521787
VZ 800 Marauder	800	1997	2003	521753
GS 850 GL	850	1980	1980	521751
GS 850 G	850	1984	1986	521752

Modèle	Cylindre	Année début	Année fin	Réf.
GS 850	850	1980	1981	521750
RF 900 R	900	2004	2007	521783
GS 1000 L	1000	1979	1979	521751
GS 1000	1000	1980	1981	521750
GSX-R 1100	1100	1989	1990	521759
GSX-R 1100 W	1100	1993	1994	521759
GSX 1100 ES semie-carenée	1100	1983	1983	521762
GSX 1100 S Katana	1100	1982	1984	521762
GSX 1100 E (ROUE BATON)	1100	1980	1981	521751
GSX 1100 L	1100	1980	1980	521751
GSX 1100 (ROUE RAYON)	1100	1980	1981	521751
GSX 1100 FP Katana	1100	1986	1988	521777
GSX 1100 FP	1100	1993	1993	521777
GS 1100 G	1100	1984	1986	521752
GSX 1100 E	1100	1986	1987	521761
GSX 1100 EF carenée	1100	1984	1987	521761
GSX 1100 ES semie-carenée	1100	1984	1987	521761
GSX-R 1100	1100	1986	1988	521763
GSX-R 1100 W	1100	1995	1995	521766
GS 1100	1100	1982	1983	521750
GSX-R 1100	1100	1991	1992	521765
GSX 1100 F	1100	1989	1996	521756
GSX 1100 G	1100	1991	1996	521757
GSX-R 1100	1100	1986	1988	521764
GSF 1200 Bandit	1200	1996	2000	521760
GSF 1200 Bandit S	1200	2001	2006	521760
GSF 1200 Bandit SAV	1200	1997	1997	521760
GSX 1200 Inazuma	1200	1999	2001	521760
VS 1400 GLF Intruder guidont plat	1400	1987	1988	521786
VS 1400 GLP Intruder guidont haut	1400	1987	1995	521786
VS 1400 GLF Intruder guidont plat	1400	1987	1988	521787
VS 1400 GLP Intruder guidont haut	1400	1987	1995	521787
SYM				
phony 125 AIR 4T	125	2009	2011	521792
phony SR 125 AIR 4T	125	2010	2016	521792
Jet 4 25 km/h AIR 4T	125	2010	2015	521796
Allo 125 AIR 4T	125	2011	2015	521788
Fiddle III 125 AIR 4T	125	2014	2016	521796
Fiddle III 125 i AIR 4T	125	2017	2017	521796
Jet 4 125 AIR 4T	125	2010	2014	521796
Jet 4 125i AIR 4T	125	2015	2016	521796
Fiddle II 125 AIR 4T	125	2007	2008	521789

Modèle	Cylindre	Année début	Année fin	Réf.
Fiddle II 125 AIR 4T	125	2010	2014	521789
Orbit 125 AIR 4T	125	2007	2008	521796
Orbit II 125 AIR 4T	125	2010	2013	521796
XPro 125 AIR 4T	125	2014	2016	521796
VS 125 AIR 4T	125	2006	2014	521794
XS 125 K	125	0	0	521797
Joyride 125 H2O 4T	125	2002	2006	521791
VS 125 AIR 4T	125	2006	2014	521795
Joyride 200 H2O 4T	200	2002	2006	521791

TRIUMPH

Daytona 750	750	1992	1992	521800
Speedmaster 800	800	2003	2004	521802
Bonneville 800	800	2001	2006	521798
Bonneville 800 America	800	2002	2006	521798
Bonneville 800 T100	800	2002	2004	521798
America 865	865	2007	2007	521802
America 865 EFI	865	2008	2011	521802
Speedmaster 865	865	2005	2007	521802
Speedmaster 865 EFI	865	2008	2011	521802
Thruxton 865	865	2004	2007	521798
Thruxton 865 EFI	865	2008	2015	521798
Bonneville 865 EFI T100	865	2008	2015	521798
Bonneville 865 SE EFI	865	2009	2013	521799
Bonneville 865 T100	865	2005	2007	521798
Scrambler 865	865	2006	2007	521799
Scrambler 865 EFI	865	2008	2015	521799
Bonneville 865	865	2007	2007	521798
Bonneville 865 EFI	865	2008	2015	521798
Adventurer 900	900	1996	2001	521800
Daytona 900	900	1993	1996	521800
Daytona 900 Super III	900	1994	1996	521800
Legend 900 TT	900	1999	2001	521800
Thunderbird 900	900	1999	2003	521800
Thunderbird 900 Sport	900	1997	2004	521800
Trident 900	900	1992	1998	521800
Trophy 900	900	1992	1996	521800
Daytona 955 i monobras	955	1997	2001	521801
Daytona 1000	1000	1992	1992	521800
Daytona 1200	1200	1993	1997	521800
VESPA				
S 125 AIR 4T	125	2007	2010	521807
S 125 i AIR 4T 2V	125	2009	2012	521807
S 125 i AIR 4T 3V	125	2012	2017	521807
S 125 i IGET AIR 4T 3V	125	2017	2020	521807

Modèle	Cylindre	Année début	Année fin	Réf.
LT 125 i AIR 4T 3V	125	2013	2016	490686
LX 125 AIR 4T	125	2005	2011	490686
LX 125 i AIR 4T 2V	125	2009	2012	490686
LX 125 i AIR 4T 3V	125	2012	2014	490686
LX Touring 125 i AIR 4T 2V	125	2010	2011	490686
GTS Super 125 i H2O 4T	125	2009	2016	521804
GTS Super ABS 125 i H2O 4T	125	2014	2016	521804
GTV 125 H2O 4T	125	2006	2008	521805
LXV 125 AIR 4T 2V	125	2006	2009	521806
LXV 125 i AIR 4T 2V	125	2010	2013	521806
LXV 125 i AIR 4T 3V	125	2013	2016	521806
ET4 125	125	1996	2000	479806
ET4 125 LEADER	125	2000	2005	479806
Granturismo 125 L H2O 4T	125	2003	2006	521803
GTS 125 H2O 4T	125	2007	2012	521803
LX 150 AIR 4T	150	2005	2013	490686
LX 150 i AIR 4T 2V	150	2009	2013	490686
LX 150 i AIR 4T 3V	150	2012	2014	490686
S 150 AIR 4T	150	2007	2010	521807
S 150 i AIR 4T 2V	150	2009	2013	521807
S 150 i AIR 4T 3V	150	2012	2014	521807
LT 150 i AIR 4T 3V	150	2014	2014	490686
LX Touring 150 i AIR 4T 2V	150	2010	2012	490686
LXV 150 AIR 4T 2V	150	2007	2009	521806
LXV 150 i AIR 4T 2V	150	2011	2015	521806
LXV 150 i AIR 4T 3V	150	2013	2016	521806
Granturismo 200 L H2O 4T	200	2003	2008	521803
GTS 250 i H2O 4T	250	2005	2016	521804
GTS ABS 250 i H2O 4T	250	2005	2009	521804
GT60 250 i H2O 4T	250	2006	2007	521805
GTV 250 i H2O 4T	250	2006	2009	521805
GTS 300 i H2O 4T	300	2012	2016	521804
GTS ABS 300 i H2O 4T	300	2014	2016	521804
GTS Super 300 i H2O 4T	300	2008	2016	521804
GTS Super ABS 300 i H2O 4T	300	2014	2018	521804
GTS Touring 300 i H2O 4T	300	2011	2013	521804
GTV 300 i H2O 4T	300	2009	2016	521805
YAMAHA				
DT 125 R	125	1990	2008	521811
DT 125 RE	125	1994	1994	521811
XT-Z 125	125	2002	2004	521811
DT 125	125	1974	1975	521816
DT 125 E	125	1976	1979	521816
SR 125	125	1989	2003	521813

Modèle	Cylindre	Année début	Année fin	Réf.
SR 125 SE	125	1980	1988	521813
TZR 125 RR	125	1997	2000	521813
XC 125 Cygnus	125	1995	2000	521813
ZUMA 125	125	0	0	521855
BWS 125	125	0	0	521855
YBR 125 ED	125	0	0	521853
DT 125 F	125	1979	1979	521810
XT 125 J	125	1982	1982	521810
XV 125 H Virago	125	1997	2000	521814
XV 125 SH Virago	125	1999	2002	521814
YP Majesty 125	125	1998	2000	521721
T 135 Crypton X	135	2007	2007	521828
T 135 Crypton X	135	2011	2011	521828
Nouvo 135	135	2005	2005	521820
YP Majesty 150	150	1998	2000	521721
DT 175	175	1974	1977	521816
DT 175 F	175	1979	1979	521810
DT 175 G	175	1980	1980	521810
DT 175 H	175	1981	1981	521810
XT 200 J	200	1982	1982	521810
XT 200 K	200	1983	1983	521810
XV 250 Virago	250	1989	1994	521849
RD 250 LC	250	1980	1982	521822
XT 250	250	1980	1990	521845
XS 250	250	1977	1980	521839
DT 250	250	1975	1976	521816
RD 250	250	1976	1979	521821
Majesty 250	250	1996	1999	521819
DT 250 D	250	1977	1977	521810
DT 250 E	250	1978	1978	521810
XV 250 N Virago	250	1995	1996	521814
XV 250 S Virago	250	1995	2000	521814
RD 350 LC	350	1980	1985	521822
RD 350 N	350	1985	1990	521822
RD 350 F	350	1985	1990	521822
XT 350	350	1985	1995	521814
XS 360	360	1977	1978	521839
RD 400	400	1976	1979	521821
XS 400 DOHC	400	1982	1987	521821
XS 400 SE	400	1980	1982	521821
XS 400	400	1979	1982	521840
DT 400 D	400	1977	1977	521810
DT 400 E	400	1978	1978	521810
SR 500 SP (frein à tambour)	500	1988	1999	521816
XT 500	500	1976	1979	521816

Modèle	Cylindre	Année début	Année fin	Réf.
RD 500	500	1984	1988	521824
XS 500	500	1975	1978	521841
TX 500	500	1973	1974	521841
SR 500	500	1978	1981	521841
XT 500 G	500	1980	1980	521810
XT 500 H	500	1981	1981	521810
SR 500 G	500	1979	1983	521814
SR 500 SP	500	1987	1989	521814
SR 500 SP	500	1978	1986	521814
XV 535 Virago	535	1988	1998	521850
XV 535 N Virago DX	535	1998	2003	521814
XV 535 H Virago DX	535	1998	2003	521814
XV 535 H Virago Flachlenker	535	1991	1993	521814
XV 535 H Virago Hochlenker	535	1991	1993	521814
XV 535 N Virago Hochlenker	535	1991	1993	521814
XT 550	550	1982	1983	521845
XJ 550	550	1981	1983	521850
XZ 550 /S	550	1982	1984	521814
FZR 600 H/M/N	600	1989	1993	521811
XT 600	600	1990	1998	521811
SRX 600	600	1987	1987	521826
SRX 600 H	600	1986	1989	521826
SRX 600 N	600	1986	1989	521826
TT 600	600	1994	1998	521831
XJ 600 SH Diversion	600	1992	2003	521834
XJ 600 H	600	1984	1991	521833
XJ 600 N	600	1984	1991	521833
XT 600 Z Tenere	600	1988	1991	521846
FZR 600 R	600	1990	1999	521850
XJ 600 SN Diversion	600	1992	2003	521834
XJ 600 NH	600	1994	2003	521814
XJ 600 NN	600	1994	2003	521814
XT 600 H	600	1984	1990	521814
XT 600 N	600	1984	1990	521814
XT 600 EH	600	1990	2003	521814
XT 600 KH	600	1991	1995	521814
XT 600 EN	600	1990	1995	521814
XT 600 KN	600	1991	1995	521814
XT 600 Z Tenere	600	1983	1987	521814
XS2 650	650	0	0	521844
XJ 650 H	650	1980	1985	521835
XJ 650 N	650	1982	1985	521835
XS 650	650	1976	1983	521841
TX 650	650	1974	1974	521841
XS 650 SE Special	650	1981	1983	521814

Modèle	Cylindre	Année début	Année fin	Réf.
XS 650 SE US Custom	650	1980	1980	521814
XS1 650	650	1970	1971	521843
XTZ 660 Tenere	660	1992	1999	521847
XV 750 Virago (ROUE BATON)	750	1992	1994	521852
XV 750 Virago (ROUE RAYON)	750	1994	1997	521852
XT-Z 750 Super Tenere	750	1989	1997	521811
FZX 750 Fazer	750	1987	1989	521813
FZ 750	750	1985	1986	521817
FZ 750 Genesis	750	1987	1994	521817
FZR 750 R OW01	750	1989	1992	521817
XS 750	750	1977	1979	521842
XTZ 750 Super Tenere	750	1989	1996	521848
FZX 750 Fazer	750	1987	1989	521814
XJ 750	750	1984	1985	521814
XJ 750	750	1981	1983	521836
XV 750	750	1981	1983	521851
TDM 850	850	1992	1993	521830
XS 850 SE	850	1980	1982	521842
XJ 900 F	900	1985	1994	521837
XJ 900 S Diversion	900	1995	2003	521837
XJ 900	900	1983	1984	521837
XV 1000 Virago	1000	1986	1988	521852
FZR 1000 Genesis Exup	1000	1991	1993	521834
FZR 1000	1000	1987	1990	521818
FZR 1000 Genesis Exup	1000	1994	1995	521814
XV 1100 SP Virago (ROUE RAYON)	1100	1994	1999	521852
XV 1100 Virago (ROUE BATON)	1100	1989	1993	521852
FJ 1100	1100	1983	1985	521813
XS 1100	1100	1980	1983	521838
V MAX-12 1200	1200	1996	2002	521830
FJ 1200	1200	1986	1997	521813
FJ 1200 A ABS	1200	1991	1994	521814
XJR 1200	1200	1995	1998	521814
XJR 1200 SP	1200	1997	1998	521814
XJR 1300	1300	1999	2003	521814
XJR 1300 SP	1300	1999	2001	521814

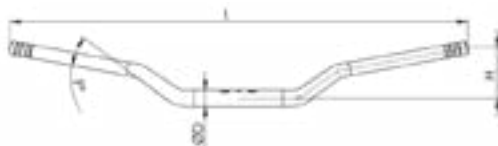

/ GUIDON MOTO

Désignation	Réf.
MRT PRO TROPHY / REPLICA (0 / 000.170.9000) ALU OVERSIZE	504522
MRT PRO / SMX PRO (0 / 000.170.0555) ALU	504192
MRT / RRX / SMX (0 / 000.170.5100) ACIER	504224

504522

504192

504224



/ GUIDON MOTO PRO RACE CROSS-BAR ALU

Désignation	Réf.
BLEU (L800)	510014
NOIR (L800)	510013
ROUGE (L800)	510015

510014

510013

510015



/ GUIDON MOTO CROSS ALU

Désignation	Réf.
ARGENT (L810 H 55)	335855
BLANC (L810 H 55)	462589
BLEU (L810 H 55)	335860
NOIR (L810 H 55)	335889
ROUGE (L810 H 55)	335874

335855

462589

335860

335889

335874

L : 810 mm - D : 22.2 mm - e : 7° - h : 55 mm - f : 15°



/ GUIDON MOTO CROSS RACING ALU

Désignation	Réf.
ARGENT	487268
NOIR	487266
TITANE	487267

487268

487266

487267

L : 740 mm - D : 22.2 mm - e : 9° - h : 70 mm - f : 15°

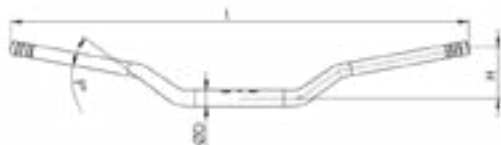

DOPPLER

/ GUIDON MOTO CROSS-BAR ALU

Désignation	Réf.
ARGENT + MOUSSE	502006
BLEU + MOUSSE	502009
NOIR + MOUSSE	502005
ROUGE + MOUSSE	502007

L : 740 mm - D : 22.2 mm - e : 9° - h : 70 mm - f : 15°



Sélection
CGN

/ GUIDON MOTO CROSS / DIRT / PIT ACIER

Désignation	Réf.
NOIR (L620)	500861
NOIR (L700)	500862



MASH

/ GUIDON MECABOITE / MOTO

Désignation	Réf.
ADAPT. MASH 50 FIFTY / DIRT TRACK - 125 SCRAMBLER	510979
ADAPT. MASH 125 SEVENTY FIVE	511038



DOPPLER

/ GUIDON MOTO OVERSIZE

Désignation	DOPPLER
28.6 ALU NOIR MAT/BLEU (L775 H 80) + MOUSSE	511020
28.6 ALU NOIR MAT/JAUNE FLUO (L775 H 80) + MOUSSE	497426
28.6 ALU NOIR MAT/ROUGE (L775 H 80) + MOUSSE	497424



MOTEUR

CYCLE

PNEUMATIQUE

ATELIER

ACCESSOIRES

ÉLECTRICITÉ

FILTRATION

FREINAGE

TRANSMISSION



YASUNI

/ GUIDON MOTO PRO RACE OVERSIZE ALU

Désignation	Réf.
BLEU (L800)	510011
ROUGE (L800)	510012
NOIR (L800)	510010



TUN'R

/ GUIDON MECABOITE / MOTO CROSS OVERSIZE

Désignation	Réf.
D 28.6 ALU ARGENT	480425
D 28.6 ALU BLANC	480424
D 28.6 ALU BLEU	480422
D 28.6 ALU NOIR	480426
D 28.6 ALU OR	480427
D 28.6 ALU ROUGE	480423

L : 810 mm - D : 28 mm - e : 4° - h : 55 mm - f : 12°



KRM

/ GUIDON MOTO OVERSIZE

Désignation	Réf.
D28.6 ALU KRM PRO RIDE SANS MOUSSE - NOIR / BLEU	515331
D28.6 ALU KRM PRO RIDE SANS MOUSSE - NOIR / OR	515332
D28.6 ALU KRM PRO RIDE SANS MOUSSE - NOIR / ROSE	515333
D28.6 ALU KRM PRO RIDE SANS MOUSSE - NOIR / ROUGE	515328



GUIDON / HANDLEBAR



/ GUIDON MOTO OVERSIZE

Désignation	Réf.
D28.6 ALU KRM PRO RIDE AVEC MOUSSE - NOIR / BLEU	515334
D28.6 ALU KRM PRO RIDE AVEC MOUSSE - NOIR / OR	515335
D28.6 ALU KRM PRO RIDE AVEC MOUSSE - NOIR / ORANGE	521173
D28.6 ALU KRM PRO RIDE AVEC MOUSSE - NOIR / ROSE	515336
D28.6 ALU KRM PRO RIDE AVEC MOUSSE - NOIR / ROUGE	515329
D28.6 ALU KRM PRO RIDE AVEC MOUSSE - NOIR / VERT	521174

515334

515335

521173

515336

515329

521174



/ GUIDON BRACELET

Désignation	Réf.
OPEN ALU CNC NOIR (DIA 28) TYPE BRACELET (PR)	518690
OPEN ALU CNC NOIR (DIA 30) TYPE BRACELET (PR)	518691



/ MOUSSE GUIDON CROSS BAR

Désignation	Réf.
MOUSSE GUIDON DOPPLER CROSS-BAR NOIR/BLEU	502164
MOUSSE GUIDON DOPPLER CROSS-BAR NOIR/GRIS	506181
MOUSSE GUIDON DOPPLER CROSS-BAR NOIR/JAUNE	502162
MOUSSE GUIDON DOPPLER CROSS-BAR NOIR/ROUGE	502163



502164

506181

502162

502163

DOPPLER

/ MOUSSE GUIDON OVERSIZE

Désignation	Réf
MOUSSE GUIDON DOPPLER OVERSIZE BLANC/JAUNE	502165
MOUSSE GUIDON DOPPLER OVERSIZE JAUNE FLUO/NOIR	502166
MOUSSE GUIDON DOPPLER OVERSIZE NOIR/BLEU	511021
MOUSSE GUIDON DOPPLER OVERSIZE NOIR/ROUGE	502167



DOPPLER

/ MOUSSE GUIDON OVERSIZE

Désignation	Réf.
MOUSSE GUIDON OVERSIZE KRM PRO RIDE - BLEU	515339
MOUSSE GUIDON OVERSIZE KRM PRO RIDE - OR	515340
MOUSSE GUIDON OVERSIZE KRM PRO RIDE - ROSE	515341
MOUSSE GUIDON OVERSIZE KRM PRO RIDE - ROUGE	515327



Stage 6 ★★

/ MOUSSE GUIDON

Désignation	Réf
MOUSSE GUIDON STAGE6 (180MM)	500043
MOUSSE GUIDON STAGE6 FATBAR	500044



domino

/ MOUSSE GUIDON

Désignation	Réfw
MOUSSE GUIDON DOMINO NOIR / CARBONE - POUR GUIDON SANS BARRE DE RENFORT	500620



/ EMBOUT DE GUIDON



515603

BRONX ARGENT D14 (X2)



515595

BRONX NOIR D14 (X2)



515596

BRONX ROUGE D14 (X2)



511995

HARLEM (DIAM 17MM) -
ALU NOIR / ARGENT (X2)



511993

HARLEM (DIAM 17MM) -
ALU NOIR / NOIR (X2)



511994

HARLEM (DIAM 17MM) -
ALU NOIR / ROUGE (X2)



511996

HARLEM (DIAM 17MM) -
ALU NOIR / BLEU (X2)



515601

INWOOD ARGENT D14 (X2)



515599

INWOOD NOIR D14 (X2)



515600

INWOOD ROUGE D14 (X2)



515602

QUEENS ARGENT D14 (X2)



515597

QUEENS NOIR D14 (X2)



515598

QUEENS ROUGE D14 (X2)



451792

CONE ROUGE D17 GUIDON ACIER (X2)



510040

PRO RACE BLEU D14 GUIDON ALU (X2)



510024

PRO RACE BLEU D17 GUIDON ACIER (X2)



510041

RACE GRIS TITANE D14 GUIDON ALU (X2)



510025

RACE GRIS TITANE D17 GUIDON ACIER (X2)

MOTEUR

CYCLE

PNEUMATIQUE

ATELIER

ACCESSOIRES

ÉLECTRICITÉ

FILTRATION

FREINAGE

TRANSMISSION

/ EMBOUT DE GUIDON



YASUNI

510037

PRO RACE NOIR D14 GUIDON ALU (X2)



YASUNI

510022

PRO RACE NOIR D17 GUIDON ACIER (X2)



YASUNI

510039

PRO RACE OR D14 GUIDON ALU (X2)



YASUNI

510028

PRO RACE OR D17 GUIDON ACIER (X2)



YASUNI

510038

PRO RACE ROUGE D14 GUIDON ALU (X2)



YASUNI

510026

PRO RACE ROUGE D17 GUIDON ACIER (X2)

/ PONTET REHAUSSE GUIDON MECABOITE / MOTO



KOM
PRO RIDE

515352

ALU POUR GUIDON 28.6MM - NOIR (X2)



KOM
PRO RIDE

515354

ALU POUR GUIDON 28.6MM - NOIR / BLEU (X2)



KOM
PRO RIDE

515355

ALU POUR GUIDON 28.6MM - NOIR / OR (X2)



KOM
PRO RIDE

515359

ALU POUR GUIDON 28.6MM - NOIR / ORANGE (X2)



KOM
PRO RIDE

515356

POUR GUIDON 28.6MM - NOIR / ROSE (X2)



KOM
PRO RIDE

515353

ALU POUR GUIDON 28.6MM - NOIR / ROUGE (X2)



KOM
PRO RIDE

515357

ALU POUR GUIDON 28.6MM - NOIR / VERT (X2)



KOM
PRO RIDE

515358

ALU POUR GUIDON 28.6MM - NOIR / VIOLET (X2)



YASUNI

510036

PRO RACE ALU NOIR GUIDON 28.6MM (X2)

/ PONTET REHAUSSE GUIDON MECABOITE GUIDON



482125

ALU POUR GUIDON 22.2MM
(CROSS/ENDURO) (X2)



493145

ALU POUR GUIDON 28.6MM
(CROSS/ENDURO) (X2)



503228

NOIR POUR GUIDON 22.2 / 28.6MM
(X2)



464988

ALU POUR GUIDON 28.6MM
(CROSS/ENDURO) (X1)



500953

ALU ARGENT GUIDON 28.6MM
(CROSS/ENDURO) (X2)



520882

ALU NEOCHROME GUIDON 28.6MM
(CROSS/ENDURO) (X2)



500952

ALU NOIR GUIDON 28.6MM
(CROSS/ENDURO) (X2)



500955

ALU OR GUIDON 28.6MM
(CROSS/ENDURO) (X2)



500954

ALU ROUGE GUIDON 28.6MM
(CROSS/ENDURO) (X2)

/ SURPONTETS / RIGIDIFICATEURS MECABOITE / MOTO



515337

ALU POUR GUIDON 28.6MM - NOIR

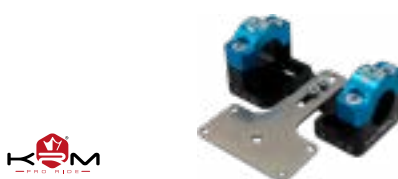

515346

ALU POUR GUIDON 28.6MM - NOIR / BLEU



515347

ALU POUR GUIDON 28.6MM - NOIR / OR



515348

ALU POUR GUIDON 28.6MM - NOIR / ROSE



515345

ALU POUR GUIDON 28.6MM - NOIR / ROUGE



515349

ALU POUR GUIDON 28.6MM - NOIR / VERT



515351

ALU POUR GUIDON 28.6MM - NOIR / ORANGE



515350

ALU POUR GUIDON 28.6MM - NOIR / VIOLET

/ PROTÈGE MAIN



335635

INTEGRAL
1 NOIR (PR)



490440

EVOLUTION - INTEGRAL
JAUNE (PR)



490441

EVOLUTION - INTEGRAL
ORANGE (PR)



490442

EVOLUTION - INTEGRAL V
ERT (PR)

/ BLOQUE LEVIER



521256

NOIR / ROUGE

/ BLOQUE ROUE



523446

BLOQUE ROUE SUR LEVIER FREIN



504204



506451



504235



508484



483506

/ LEVIER D'EMBRAYAGE MECABOITE

Désignation	RIEJU	MBK / YAMAHA	TEKNIX
OEM RIEJU MRT / MRT PRO 2018-> (0 / 000.830.8301) ALU	504204		
OEM RIEJU MRT / MRT PRO / MRX / SMX / SPIKE / TANGO ->18 (0 / 000.830.1002)	506451		
OEM RIEJU MRX / RS2 / RS3 / SMX (0 / 000.830.0310) NOIR	504235		
OEM YAMAHA TZR 50 / YZF-R 125 (5D7H39121000) NOIR		508484	
LEVIER EMBRAYAGE MECABOITE / MOTO TEKNIX ADAPT. XPOWER / TZR 96->03 / 125 TZR 90->95 ALU			483506



/ LEVIER DE FREIN



510779



510778

Désignation	Réf.
ALU NOIR LONG (PR) - AVEC CONTACTEUR DE STOP + TROU POUR RETRO	510779
ALU NOIR LONG (PR) - AVEC CONTACTEUR DE STOP ET CABLE + TROU POUR RETRO	510778

MOTEUR

CYCLE

PNEUMATIQUE

ATELIER

ACCESSOIRES

ÉLECTRICITÉ

FILTRATION

FREINAGE

TRANSMISSION



/ LEVIER DE FREIN MAXI SCOOTER

Désignation	GAUCHE		DROIT	
	DOMINO	TEKNIX	DOMINO	TEKNIX
DOMINO ADAPT. 125 / 250 XMAX / XCITY / SKYCRUISER 06->	520040		520041	
DOMINO ADAPT. 125 / 250 // 300 / 400 / 500 MBK / YAMAHA / PIAGGIO	520043		520042	
TEKNIX ADAPT. 125 CYGNUS / FLAME X 2004->2006		499724		499725
TEKNIX ADAPT. 125 CYGNUS / FLAME X 2007->2011		499724		499726
TEKNIX ADAPT. 125 HONDA PCX 10->		485312		485311
TEKNIX ADAPT. 125 HONDA SHI 09-> / 250 FORZA / JAZZ 05->08		490689		490690
TEKNIX ADAPT. 125 KYMCO DINK 06->07 / GRAND DINK 12->		490695		490696
TEKNIX ADAPT. 125 SYM GTS / JOYMAX / HD / 400 MAXSYM 10->		486995		486994
TEKNIX ADAPT. 125 / 200 / 300 KYMCO DOWNTOWN 09-> / SUPERDINK 09				490692
TEKNIX ADAPT. 125 / 250 XMAX / XCITY / SKYCRUISER 06->		477437		477446
TEKNIX ADAPT. 125 / 400 BURGMAN 02-> / SATELIS 05-> / GEOPOLIS		477448		477436
TEKNIX ADAPT. 125 / 400 PIAGGIO MP3 / X9 / X9 EVO / BEVERLY		485699		485698
TEKNIX ADAPT. 50 / 125 AGILITY R16 08-> / GRAND DINK 06>07 / B&W		490693		490694
TEKNIX ADAPT. 500 YAMAHA TMAX 08-> / 530 TMAX 12->		485697		485696
TEKNIX ADAPT. 600 / 650 BMW C600 / C650 11-> / 650 BURGMAN 06->		490688		490687
TEKNIX ADAPT. X8 / X9 / MP3 / MAJESTY / SKYLINER (98 / 07) GAUCHE / DROIT		477447		477447
TEKNIX ADAPT. 50 / 125 LIBERTY / VESPA ET4 (GRIMECA)				491154
TEKNIX ADAPT. 125 MAJESTY / SKYLINER 98->07 DOITE OU GAUCHE		485700		485700
TEKNIX ADAPT. 125 VESPA GTS / GTV 07-> / GRANTURISMO DOITE OU GAUCHE		486993		486993



/ LEVIER DE FREIN SCOOTER / MAXI SCOOTER

Désignation	TEKNIX	MBK / YAMAHA
LEVIER FREIN SCOOTER DROIT TEKNIX ADAPT. 50 / 125 TWEET / FIDDLE 2 / ORBIT 2 / SYMPHONY / SYMPLY	484314	
LEVIER FREIN SCOOTER / MAXI SCOOTER DROIT TEKNIX ADAPT 50 / 125 AGILITY VITALITY 04-07	477450	
LEVIER FREIN SCOOTER / MAXI SCOOTER GAUCHE TEKNIX ADAPT. 50 / 125 AGILITY 05-07 / VITALITY 04-07	477449	
LEVIER FREIN SCOOTER / MOTO DROIT OEM OVETTO / NEOS 2008-> / YZF R125 12->13 (5D7H39222000)		508454



482743

483514

483512

483510

497266

497267

497269

497265

497268

/ LEVIER DE FREIN MECABOITE

Désignation	TEKNIX	TUNR
LEVIER FREIN MECABOITE TEKNIX ADAPT. SENDA DRD PRO / GPR 10-> / BETA RR / RS4 / SHERCO / XPS / XR7 / NK7	482743	
LEVIER FREIN MECABOITE / MOTO TEKNIX ADAPT. 50 TZR / XPOWER 1996->2003 / 125 TZR 1990->1995 ALU	483514	
LEVIER FREIN MECABOITE / MOTO TEKNIX ADAPT. 50 / 125 RS2 / XR6 NOIR	483512	
LEVIER FREIN MECABOITE / MOTO TEKNIX ADAPT. RS50 2006-2009 / 50 / 125 GPR 2004-2009 / SC 125 NOIR	483510	
LEVIER MECABOITE / MOTO TUN'R ADAPT. RIEJU MRT 14->18 / MARATHON 11->18 125 (J.JUAN) ARGENT (P)		497266
LEVIER MECABOITE / MOTO TUN'R ADAPT. RIEJU MRT 14->18 / MARATHON 11->18 125 (J.JUAN) BLANC (PR)		497267
LEVIER MECABOITE / MOTO TUN'R ADAPT. RIEJU MRT 14->18 / MARATHON 11->18 125 (J.JUAN) BLEU (PR)		497269
LEVIER MECABOITE / MOTO TUN'R ADAPT. RIEJU MRT 14->18 / MARATHON 11->18 125 (J.JUAN) NOIR (PR)		497265
LEVIER MECABOITE / MOTO TUN'R ADAPT. RIEJU MRT 14->18 / MARATHON 11->18 125 (J.JUAN) ROUGE (PR)		497268



/ POIGNEE DE FREIN

Désignation	Réf.
POIGNEE FREIN MAXI SCOOTER GAUCHE ADAPT. 125 MAJESTY / SKYLINER	485555



/ CABLE FREIN

Modèle	Cylindre	Année début	Année fin	Réf.
APRILIA				
Sport City One 125 AIR 4T	125	2008	2011	521871
BMW				
R 26	250	1956	1959	521874
R 27	250	1961	1965	521874
R 25 250/3	250	1954	1955	521873
R 35	350	0	0	521875
R 51	500	1951	1953	521879
R 50/2	500	1968	1970	521876
R 50/2	500	1968	1970	521877
R 51	500	1950	1953	521878
R 67	600	1952	1955	521879
R 68	600	1952	1954	521879
R 60/2	600	1967	1970	521876
R 69 S	600	1967	1970	521876
R 60/2	600	1967	1970	521877

Modèle	Cylindre	Année début	Année fin	Réf.
R 69 S	600	1967	1970	521877
R 67	600	1951	1955	521878
C 600 Sport	600	2011	2015	521872
R 60/6	600	1974	1976	521880
C 650 Sport	650	2015	2021	521872
C 650 GT	650	2011	2021	521872
GILERA				
Runner FX 125 H2O 2T	125	1998	2002	521884
Runner FXR 180 H2O 2T	180	1998	2002	521884
Fuoco LT 500i H2O 4T	500	2013	2014	521881
Fuoco RL 500i H2O 4T	500	2007	2013	521881
Fuoco LT 500i H2O 4T	500	2013	2014	521882
Fuoco RL 500i H2O 4T	500	2007	2013	521882
HONDA				
CB 125 J	125	1975	1979	521890
SL 125 S	125	1971	1976	521890

Modèle	Cylindre	Année début	Année fin	Réf.
TL 125 S	125	1978	1978	521910
XL 125 K	125	1976	1978	521914
CB 125 K3/K5	125	0	0	521891
Activa S 125	125	2017	2019	521886
Fizy 125	125	2012	2013	521898
CG 125	125	1998	1999	521894
Fizy 125	125	2012	2013	521899
CM 125	125	1982	1999	521896
CG 125 Brasil	125	1984	1997	521895
PCX 125	125	2010	2014	521904
CB 125 T2 Twin	125	1979	1986	521892
Activa S 125	125	2017	2019	521887
PCX 150	150	2012	2013	521905
PCX 150	150	2015	2018	521906
XL 250 K	250	1976	1978	521915
XL 250 K	250	1976	1978	521916
XL 250 S	250	1978	1979	521917
CB 450 K	450	1970	1970	521893
XL 500 R Pro Link	500	1982	1985	521918
XL 500 S	500	1979	1981	521919
HYOSUNG				
GV 125	125	0	0	521920
Gv 250	250	0	0	521920
KAWASAKI				
KE 125	125	1976	1979	521924
EN 500 VULCAN	500	1990	1996	521923
EN 500	500	1990	1995	521921
EN 500	500	1996	2009	521922
Vulcan 800 Classic VN800	800	1996	2005	521925
Vulcan 800 VN800	800	1995	2005	521925
ZIR 1000	1000	1978	1978	521926
ZIR 1000	1000	1980	1980	521926
KYMCO				
Agility RS 125	125	2009	2009	521927
PIAGGIO				
TPH 125 2T Typhoon	125	1995	1999	521955
SKR 125 Skipper	125	1994	1997	521957
TPH 125 X-R 2T Typhoon	125	2000	2003	521955
Hexagon 125 LX 2T	125	1998	2000	521946
Hexagon 125 LX4	125	1998	2000	521946
Liberty 125	125	2002	2002	521956
MP3 Hybrid 125i H2O 4T	125	2009	2009	521882
Skipper 125	125	2000	2002	521959
Fly 125 4T 3V	125	2013	2015	521943
Liberty 125i IGET AIR 4T	125	2015	2017	521947

Modèle	Cylindre	Année début	Année fin	Réf.
Liberty Sport 125i IGET AIR 4T 3V	125	2015	2017	521947
Liberty 125i LEM AIR 4T	125	2013	2015	521948
MP3 125 H2O 4T	125	2006	2008	521881
MP3 125i H2O 4T	125	2008	2011	521881
MP3 125i Touring H2O 4T	125	2011	2012	521881
MP3 Hybrid 125i H2O 4T	125	2009	2009	521881
MP3 ERL Yourban 125i H2O 4T	125	2011	2013	521954
MP3 125 H2O 4T	125	2006	2008	521882
MP3 125i H2O 4T	125	2008	2011	521882
MP3 125i Touring H2O 4T	125	2011	2012	521882
MP3 ERL Yourban 125i H2O 4T	125	2011	2013	521953
Liberty 125 4T	125	2006	2007	521950
Liberty 125 4T 2V	125	2009	2012	521950
Liberty 125 4T 2V ie PTT	125	2012	2012	521950
Liberty 125 4T Delivery	125	2007	2009	521950
Liberty 125 4T PTT	125	2006	2007	521950
Liberty 125 4T Sport	125	2006	2008	521950
Hexagon 150	150	1994	1998	521946
Hexagon 150 catalyst	150	1996	1998	521946
Fly 150 4T 3V	150	2013	2015	521943
Fly 150	150	2006	2013	521944
Liberty 150i IGET AIR 4T 3V	150	2015	2017	521947
Liberty Sport 150i IGET AIR 4T	150	2015	2017	521947
Liberty 150i LEM AIR 4T 3V	150	2013	2014	521948
Liberty 150 4T	150	2008	2008	521950
Liberty 150 4T MOC	150	2009	2013	521950
Liberty 150 4T Sport	150	2008	2008	521950
Hexagon 180 LXT 2T	180	1998	2000	521946
Liberty 200 4T	200	2006	2008	521950
Liberty 200 4T Sport	200	2006	2007	521950
Hexagon 250 GT	250	1998	2000	521946
MP3 LT 250i H2O 4T	250	2008	2009	521882
MP3 RL 250i H2O 4T	250	2006	2008	521882
MP3 250	250	2007	2010	521952
MP3 RL MIC 250i H2O 4T	250	2008	2010	521882
MP3 RL MIC 250i H2O 4T	250	2008	2010	521881
MP3 LT 250i H2O 4T	250	2008	2009	521881
MP3 RL 250i H2O 4T	250	2006	2008	521881
MP3 LT Yourban 300i H2O 4T	300	2011	2018	521953
MP3 LT 300i H2O 4T	300	2009	2014	521882
MP3 LT Business 300i H2O 4T	300	2014	2018	521882
MP3 LT Hybrid 300i H2O 4T	300	2010	2011	521882
MP3 LT Sport 300i H2O 4T	300	2011	2018	521882
MP3 LT Touring 300i H2O 4T	300	2011	2013	521882
MP3 RL Hybrid 300i H2O 4T	300	2010	2013	521882

Modèle	Cylindre	Année début	Année fin	Réf.
MP3 RL MIC 300i H2O 4T	300	2011	2011	521882
MP3 RL Touring 300i H2O 4T	300	2011	2012	521882
MP3 RL Hybrid 300i H2O 4T	300	2010	2013	521881
MP3 RL MIC 300i H2O 4T	300	2011	2011	521881
MP3 RL Touring 300i H2O 4T	300	2011	2012	521881
MP3 LT 300i H2O 4T	300	2009	2014	521881
MP3 LT Business 300i H2O 4T	300	2014	2018	521881
MP3 LT Hybrid 300i H2O 4T	300	2010	2011	521881
MP3 LT Sport 300i H2O 4T	300	2011	2018	521881
MP3 LT Touring 300i H2O 4T	300	2011	2013	521881
MP3 ERL Yourban 300i H2O 4T	300	2011	2015	521954
MP3 LT Yourban 300i H2O 4T	300	2011	2018	521954
MP3 ERL Yourban 300i H2O 4T	300	2011	2015	521953
MP3 HPE 350i Sport H2O 4T	350	2018	2020	521881
MP3 HPE 350i Sport H2O 4T	350	2018	2020	521882
MP3 LT 400i H2O 4T	400	2008	2010	521882
MP3 LT Sport 400i H2O 4T	400	2008	2010	521882
MP3 LT Touring 400i H2O 4T	400	2011	2011	521882
MP3 RL 400i H2O 4T	400	2007	2008	521882
MP3 RL MIC 400i H2O 4T	400	2008	2010	521882
MP3 RL Touring 400i H2O 4T	400	2011	2011	521882
MP3 RL 400i H2O 4T	400	2007	2008	521881
MP3 RL MIC 400i H2O 4T	400	2008	2010	521881
MP3 RL Touring 400i H2O 4T	400	2011	2011	521881
MP3 LT 400i H2O 4T	400	2008	2010	521881
MP3 LT Sport 400i H2O 4T	400	2008	2010	521881
MP3 LT Touring 400i H2O 4T	400	2011	2011	521881
MP3 HPE 500i Sport H2O 4T	500	2018	2020	521882
MP3 LT Business 500i H2O 4T	500	2011	2018	521882
MP3 LT Sport 500i H2O 4T	500	2011	2018	521882
MP3 RL 500i H2O 4T	500	2007	2009	521882
MP3 RL Business 500i H2O 4T	500	2011	2012	521882
MP3 RL Business 500i H2O 4T	500	2015	2018	521882
MP3 RL Sport 500i H2O 4T	500	2010	2012	521882
MP3 RL Sport 500i H2O 4T	500	2015	2018	521882
MP3 RL Touring 500i H2O 4T	500	2010	2010	521882
MP3 RL 500i H2O 4T	500	2007	2009	521881
MP3 RL Business 500i H2O 4T	500	2011	2012	521881
MP3 RL Business 500i H2O 4T	500	2015	2018	521881
MP3 RL Sport 500i H2O 4T	500	2010	2012	521881
MP3 RL Sport 500i H2O 4T	500	2015	2018	521881
MP3 RL Touring 500i H2O 4T	500	2010	2010	521881
MP3 HPE 500i Business H2O 4T	500	2018	2020	521881
MP3 HPE 500i Sport H2O 4T	500	2018	2020	521881

Modèle	Cylindre	Année début	Année fin	Réf.
MP3 LT Business 500i H2O 4T	500	2011	2018	521881
MP3 LT Sport 500i H2O 4T	500	2011	2018	521881
MP3 HPE 500i Business H2O 4T	500	2018	2020	521882
SUZUKI				
GZ 125	125	1998	2011	521970
AN 125	125	0	0	521968
TS 125 C	125	0	0	521975
TS 125 C ER	125	0	0	521975
GZ 125 Marauder	125	2008	2013	521971
TS 185 ER	185	0	0	521975
GZ 250 MARAUDER	250	1999	2010	521972
VS 600 GL Intruder	600	1995	1997	521977
VS 600 GLU Intruder	600	1995	1997	521977
VS 750 GLF Intruder guidont plat	750	1986	1989	521977
VS 750 GLP Intruder guidont haut	750	1986	1991	521977
VZ 800 MARAUDER	800	1997	2004	521978
VS 800 GL Intruder	800	1992	1995	521977
VESPA				
ET4 125	125	1996	2000	521883
ET4 125 LEADER	125	2000	2005	521956
LX 125	125	2005	2009	521956
LX 125 ie 2V	125	2010	2013	521956
LX 125 ie 2V Touring	125	2010	2013	521956
S 125	125	2007	2009	521956
S 125 ie 2V /College	125	2010	2014	521956
LX 125 i AIR 4T 2V	125	2009	2012	521985
LX Touring 125 i AIR 4T 2V	125	2010	2011	521985
S 125 i AIR 4T 2V	125	2009	2012	521985
LT 125 i AIR 4T 3V	125	2013	2016	521982
LX 125 i AIR 4T 3V	125	2012	2014	521982
S 125 i AIR 4T 3V	125	2012	2017	521982
125 4T 3V I GET IE PRIMAVERA	125	2016	2017	521981
PRIMAVERA 125 4T 3V IGET ABS	125	2016	2017	521981
SPRINT IGET 125 4T	125	2016	2017	521981
SPRINT IGET 125 4T ABS	125	2016	2017	521981
LX Primavera 125 4T 3V	125	2013	2017	521984
Sprint 125 4T 4V	125	2014	2015	521984
Primavera 125 4T 3V	125	2016	2018	521984
PX 125	125	2007	2017	521988
PX 125	125	1998	2006	521988
PX 200	125	1998	2006	521988
LX 150 i AIR 4T 2V	150	2009	2013	521985
LX Touring 150 i AIR 4T 2V	150	2010	2012	521985

CABLE FREIN & CABLE STARTER / BRAKE CABLE & STARTER CABLE

Modèle	Cylindre	Année début	Année fin	Réf.
S 150 i AIR 4T 2V	150	2009	2013	521985
LT 150 i AIR 4T 3V	150	2013	2013	521982
LX 150 i AIR 4T 3V	150	2012	2014	521982
150 SPRINT IGET 4T3V IE	150	2016	2017	521981
PRIMAVERA 150 4T 3V IGET ABS	150	2016	2017	521981
Primavera 150 4T 3V	150	2013	2016	521984
Sprint 150 4T 3V	150	2015	2015	521984
PX 150	150	2011	2017	521988
PX 150	150	1998	2006	521988
YAMAHA				
YP 125 R Majesty	125	1998	1999	522008
YS 125	125	2017	2017	522009
BWS 125	125	0	0	521992
RS 125 Drum	125	0	0	514658
Cygnus X 125	125	2005	2005	521993

Modèle	Cylindre	Année début	Année fin	Réf.
DT 125 MX	125	0	0	521994
SR 125 Drum	125	0	0	521994
XT 125	125	0	0	521994
DT 175	175	0	0	521994
XT 250	250	1980	1990	522003
DT 250	250	1976	1978	521995
DT 360	360	1974	1974	521995
DT 400	400	1976	1978	521995
XT 500	500	1976	1977	522004
SR 500 SP (frein à tambour)	500	1988	1990	522000
XT 500	500	1980	1989	522005
XT 500 S Edition	500	1988	1989	522005
Virago 535	535	1987	2000	522001
XT 550	550	1982	1983	522006
XS 650	650	1970	1971	522002



/ LEVIER DE STARTER MECABOITE

Désignation	Réf.
LEVIER STARTER MECABOITE OEM RIEJU MRT / MRT PRO / RS3 / TANGO 2018-> (0 / 000.830.8302)	504524



/ CABLE STARTER

Modèle	Cylindre	Année début	Année fin	Réf.
APRILIA				
RS 125	125	1999	2010	523229
RSV 1000	1000	1998	2003	523232
RSV 1000 SP	1000	1999	1999	523232
RSV 1000 Tuono	1000	2002	2005	523232
BMW				
R 50/5	500	1970	1979	523248
R 50/5	500	1970	1979	523247
R 60	600	1977	1978	523249
R 60/6	600	1974	1976	523249
R 60	600	1977	1978	523250
R 60/6	600	1974	1976	523250
R 65	650	1986	1986	523255
R 65	650	1979	1985	523253
R 65	650	1979	1985	523252
R 65 LS	650	1981	1985	523252
R 65	650	1986	1986	523254

Modèle	Cylindre	Année début	Année fin	Réf.
F 650	650	1997	2000	523235
F 650 ST	650	1997	1997	523235
R 65	650	1979	1985	523251
R 65 LS	650	1981	1985	523251
K 75	740	1986	1995	523238
K 75	740	1986	1994	523237
K 75	740	1986	1995	523239
R 75	750	1977	1977	523251
R 75/6	750	1974	1976	523251
R 80/7	800	1978	1980	523256
R 80	800	1985	1987	523255
R 80	800	1981	1987	523253
R 80	800	1983	1987	523254
R 80/7	800	1978	1980	523254
R 80/7	800	1978	1980	523251
R 850 R	850	1996	1997	523258
R 850 R	850	2003	2004	523259
R 850 R	850	1996	1997	523257

Modèle	Cylindre	Année début	Année fin	Réf.
R 90 S	900	1970	1979	523248
R 90 S	900	1974	1976	523260
R 90 S	900	1970	1979	523247
R 90/6	900	1974	1976	523251
K1	1000	1990	1992	523237
R 100/7 T	1000	1977	1978	523256
R 100 RS	1000	1977	1977	523256
R 100 RS	1000	1979	1984	523256
R 100 RT	1000	1978	1984	523256
R 100 GS	1000	1988	1995	523255
R 100 S	1000	1977	1980	523256
R 100 GS Paris-Dakar	1000	1989	1996	523255
R 100 T	1000	1979	1984	523256
R 100 R	1000	1992	1994	523255
R 100 R Mystik	1000	1994	1995	523255
R 100 RS	1000	1988	1988	523255
R 100 RS	1000	1992	1992	523255
R 100 RT	1000	1988	1996	523255
R 100 GS	1000	1988	1995	523253
R 100 GS Paris-Dakar	1000	1989	1996	523253
R 100 R	1000	1992	1994	523253
R 100 R Mystik	1000	1994	1995	523253
R 100 RT	1000	1978	1984	523253
R 100 RT	1000	1988	1996	523253
R 100 T	1000	1979	1984	523253
K 100 LT	1000	1987	1991	523239
K 100 RT	1000	1984	1988	523239
R 100 CS	1000	1981	1981	523240
R 100 T	1000	1979	1984	523240
K 100 RS	1000	1984	1992	523237
R 100 RS	1000	1977	1977	523240
R 100 RS	1000	1979	1984	523240
R 100 RT	1000	1978	1984	523240
K 100	1000	1985	1986	523239
R 100 R	1000	1992	1994	523254
R 100 R Mystik	1000	1994	1995	523254
R 100 RT	1000	1988	1996	523254
R 100 GS	1000	1988	1995	523254
R 100 CS	1000	1981	1981	523241
R 100 RS	1000	1979	1984	523241
R 100 T	1000	1979	1984	523241
R 80/7	1000	1978	1980	523241
R 100/7 T	1000	1977	1978	523251
R 100 RS	1000	1977	1977	523251
R 100 RS	1000	1979	1984	523251
R 100 RT	1000	1978	1984	523251

Modèle	Cylindre	Année début	Année fin	Réf.
R 100 S	1000	1977	1980	523251
R 100 T	1000	1979	1984	523251
R 1100 RT	1100	1995	2001	523258
K 1100 LT	1100	1992	1997	523236
R 1100 S	1100	1998	2004	523243
R 1100 GS	1100	1994	1999	523258
R 1100 R	1100	1995	2001	523258
R 1100 RS	1100	1992	2001	523258
K 1100 RS	1100	1993	1996	523237
R 1100 S	1100	1998	2004	523242
R 1100 GS	1100	1994	1999	523257
R 1100 R	1100	1995	2001	523257
R 1100 RS	1100	1992	2001	523257
R 1100 RT	1100	1995	2001	523257
R 1150 R	1150	2001	2005	523245
R 1150 R Rockster	1150	2003	2005	523259
R 1150 RS	1150	2001	2004	523246
R 1150 GS	1150	1999	2004	523244
R 1150 GS Adventure	1150	2002	2006	523244
R 1150 RT	1150	2000	2006	523244
DUCATI				
Supersport 400 SS	400	1993	1995	523272
Supersport 600 SS Carenata	600	1994	1998	523272
Supersport 600 SS Nuda	600	1994	1998	523272
Monster 600	600	1994	2001	523263
Monster 600 City	600	1999	2000	523263
Monster 600 City Dark	600	1999	2000	523263
Monster 600 Dark	600	1998	2001	523263
Monster 600 Metallic	600	2000	2001	523263
Multistrada 620 ie DD	620	2005	2006	523266
Multistrada 620 ie MD Dark	620	2005	2006	523266
Monster 620 ie DD	620	2002	2004	523264
Monster 620 ie DD Dark	620	2004	2005	523264
Monster 620 ie DD	620	2002	2006	523264
Monster 620 ie DD Dark	620	2004	2005	523264
Monster 620 ie MD Dark	620	2003	2006	523264
Monster 620 S ie	620	2002	2003	523264
Monster 695	620	2007	2008	523264
S 620 ie Sport Carenata	620	2003	2003	523267
S 620 ie Sport Nuda	620	2003	2003	523267
Monster 696	696	2008	2012	523265
Monster 696 ABS	696	2010	2014	523265
Monster 696 Anniversaire ABS	696	2013	2013	523265
Supersport 750 SS Carenata	750	1994	1998	523272
Supersport 750 SS Nuda	750	1991	1998	523272

Modèle	Cylindre	Année début	Année fin	Réf.
Monster 750	750	1996	2001	523263
Monster 750 City	750	1999	2000	523263
Monster 750 City Dark	750	1999	1999	523263
Monster 750 Dark	750	1999	2001	523263
Monster 750 Metallic	750	2000	2001	523263
S 750 ie Sport Carenata	750	2001	2002	523268
S 750 ie Sport Nuda	750	2001	2002	523268
Monster 750 ie	750	2002	2002	523264
Monster 750 ie Dark	750	2002	2002	523264
Monster 800 S2R	800	2005	2007	523264
Monster 800 S2R Dark	800	2005	2006	523264
Monster 800 ie	800	2004	2004	523264
Monster 800 ie Dark	800	2003	2003	523264
Monster 800 ie S	800	2003	2003	523264
SL 900 Super Light	900	1992	1997	523272
Supersport 900 SS Carenata	900	1990	1998	523272
Supersport 900 SS FE Final Edition	900	1998	1998	523272
Supersport 900 SS Nuda	900	1991	1998	523272
907 900 ie	900	1990	1993	523261
Monster 900	900	1993	1999	523263
Monster 900 City	900	1999	1999	523263
Monster 900 City Dark	900	1999	1999	523263
Monster 900 Cromo	900	1998	1999	523263
Monster 900 S	900	1998	1999	523263
Supersport 900 SS ie Carenata	900	1999	2002	523268
Supersport 900 SS ie Nud	900	1999	2002	523268
Monster 900 ie Dark	900	2002	2002	523264
ST4 Sporttouring	916	1999	2003	523271
ST2 944 Sporttouring	944	1997	2003	523270
ST 4S 996 Sporttouring	996	2004	2005	523269
ST 4S 996 Sporttouring ABS	996	2004	2005	523269
998 Biposto/Monoposto	998	2002	2003	523262
998 S Monoposto	998	2002	2002	523262
Monster 1000 ie	1000	2003	2005	523264
ST3 1000 Sporttouring	1000	2004	2005	523269
Supersport 1000 SS Carenata	1000	2003	2004	523267
Supersport 1000 SS Nuda	1000	2003	2003	523267
Supersport DS 1000 SS Carenata	1000	2005	2007	523267
HONDA				
XL 125 S	125	1979	1982	523327
CA 125 Rebel	125	1995	1996	523274
CA 125 Rebel 80 Km/h	125	1995	1996	523274
CBR 125 R	125	2004	2008	523289
CBR 125 RS	125	2005	2008	523289

Modèle	Cylindre	Année début	Année fin	Réf.
XL 125 V Varadero	125	2001	2006	523328
VT 125 C Shadow	125	2001	2005	523322
VT 125 C Shadow 80 Km/h	125	2001	2005	523322
VT 125 C2 Shadow	125	2001	2002	523322
VT 125 C2 Shadow 80 Km/h	125	2001	2002	523322
NSR 125 R	125	1996	2003	523306
CBF 150	150	2007	2007	523286
CBF 150	150	2010	0	523287
XL 185 S	185	1979	1984	523327
CB 250 RS	250	1981	1984	523277
XL 250 S	250	1978	1982	523277
XL 250 R	250	1984	1987	523330
CB 250 Nighthawk	250	1992	2008	523276
XL 250 K	250	1972	1975	523329
XL 350 R	350	1983	1990	523330
VFR 400	400	1990	1991	523317
CBR 400 RR	400	1990	1999	523291
CB 400 SF	400	1995	1998	523279
CB 400 F	400	1989	1990	523278
VFR 400 R NC24	400	0	0	523318
CBR 400	400	1988	1989	523290
XBR 500	500	1985	1985	523326
GL 500 D Silverwing	500	1980	1985	523305
CB 500	500	1994	1996	523280
VT 500 E	500	1985	1985	523323
CX 500 Euro Sports E	500	1982	1986	523301
CX 500	500	1977	1983	523300
CX 500 C	500	1980	1981	523300
CX 500 C Custom	500	1982	1984	523300
VT 600 C Shadow	600	1995	1996	523324
XL 600 V Transalp	600	1987	2000	523332
XL 600 R	600	1983	1987	523331
CBR 600 F	600	1991	1994	523293
CB 600 F Hornet	600	1998	2002	523281
CB 600 S F2 Hornet S	600	2000	2003	523281
CBR 600 F	600	1987	1990	523292
CBR 600 F	600	1995	1998	523294
CBR 600 F	600	1999	2000	523295
NTV 650 Hawk	650	1989	1991	523308
XL 650 V Transalp	650	2000	2007	523332
XRV 650 Africa Twin	650	1988	1990	523332
NX 650	650	1988	2002	523309
SLR 650	650	1997	2001	523309
NT 650 V Deauville	650	1998	2001	523307
NT 650 V Deauville CBS	650	2002	2005	523307
NX 650 Dominator	650	1990	1994	523310

Modèle	Cylindre	Année début	Année fin	Réf.
NX 650 Dominator Pinion coarsely toothed	650	1988	1988	523310
CX 650	650	1983	1983	523302
NX 650 Dominator Pinion fine-toothed	650	1989	1989	523310
CB 650 SC Custom	650	1982	1983	523282
VF 750 C	750	1983	1983	523315
XRV 750 Africa Twin	750	1990	1992	523332
CB 750 F2 Seven Fifty	750	1992	2003	523283
CB 750 Nighthawk	750	1991	1992	523283
CB 750 K Four	750	1977	1978	523285
VT 750 C Shadow	750	1997	2000	523325
VT 750 C2 Shadow Aero	750	1997	2000	523325
XRV 750 Africa Twin	750	1993	2003	523333
VT 750 DC Black Widow	750	2000	2003	523325
VF 750 C Magna	750	1995	1996	523316
CBX 750 F	750	1984	1986	523299
VFR 750 F	750	1986	1987	523320
VF 750 C	750	1982	1982	523314
VFR 750	750	1994	1997	523319
VFR 750 F	750	1990	1993	523321
CB 750 K	750	1979	1982	523284
CB 750 F	750	1979	1981	523284
CBR 900 RR	900	1997	1999	523297
CBR 900 RR	900	1992	1996	523296
CBR 1000 F	1000	1987	1989	523288
CBX 1000 CB1	1000	1978	1982	523298
GL 1000	1000	1976	1979	523303
VF 1000 R	1000	1984	1986	523313
GL 1100	1100	1980	1982	523303
CB 1100 X-II	1100	2000	2001	523275
VF 1100 C	1100	1983	1986	523302
GL 1500 A Gold Wing Aspencade	1500	1991	2000	523304
GL 1500 Gold Wing	1500	1990	1990	523304
GL 1500 I Gold Wing Interstate	1500	1991	1996	523304
GL 1500 SE Gold Wing Special Edition	1500	1990	2000	523304
HYOSUNG				
GV 125	125	0	0	523337
GT 125	125	0	0	523336
GT 150	150	0	0	523336
GV 250	250	0	0	523337
GF 125	125	0	0	523334
RX 125	125	0	0	523335
KAWASAKI				
KMX 125	125	1999	2001	523349

Modèle	Cylindre	Année début	Année fin	Réf.
KLR 250	250	1985	2005	523346
KH 500	500	1973	1975	523345
500 SS	500	1969	1971	523338
H1	500	1969	1971	523338
GPZ 500 S	500	1987	2003	523342
ER 500 D Twister	500	2001	2006	523340
ER 500 C Twister	500	2001	2006	523340
ER 500 A Twister	500	1997	2000	523339
ER 500 B Twister	500	1997	2000	523339
ZX-6R 600 F Ninja	600	1995	1997	523355
ZZR 600 E	600	1993	2006	523355
ZX-6R 600 J Ninja	600	2000	2002	523356
ZX-6R 600 H Ninja catalyst	600	1998	1999	523356
ZX-6 600 Ninja	600	1990	1993	523354
KLR 600 A	600	1984	1984	523347
KLR 600 B	600	1985	1989	523347
ZX-6R 636 A Ninja	636	2002	2002	523356
KLR 650 C	650	1995	2004	523348
KH 750	750	1973	1975	523345
GPZ 750 R Ninja	750	1985	1985	523343
ZX-7R 750 P Ninja	750	1996	2002	523357
H2 750 Mach 4	750	1972	1972	523344
H2 750 A Mach 4	750	1973	1973	523344
ZXR 750	750	0	0	523359
GPX 750	750	0	0	523359
VN 800 B Classic	800	2000	2006	523352
VN 800 C Drifter	800	1999	2000	523352
VN 800 E Drifter	800	2001	2003	523352
ZX-9R 900 C Ninja	900	1998	1999	523358
ZX-9R 900 D Ninja catalyst	900	1998	1999	523358
ZX-9R 900 D Ninja Kat	900	1998	1999	523358
GPZ 900 R Ninja	900	1990	1994	523343
GPZ 900 R Ninja	900	1986	1989	523343
ZX-9R 900 F Ninja	900	2002	2003	523357
ZR 1100 A Zephyr (ROUE BATON)	1100	1992	1995	523353
ZR 1100 B Zephyr (ROUE RAYON)	1100	1996	1997	523353
GPZ 1100 E	1100	1995	1998	523341
GPZ 1100 F ABS	1100	1996	1998	523341
ZRX 1100 C	1100	1997	2000	523341
ZZR 1100	1100	0	0	523359
ZRX 1200 C	1200	2001	2004	523341
ZRX 1200 R (modèle F)	1200	2001	2006	523341
ZRX 1200 S semie-carenée	1200	2001	2004	523341
VN 1500 FI Classic Tourer	1500	2000	2004	523351

Modèle	Cylindre	Année début	Année fin	Réf.
VN 1500 FI N Classic	1500	2000	2002	523351
VN 1500 J Drifter	1500	1999	2000	523351
VN 1500 P Mean Streak	1500	2002	2003	523351
VN 1500 R Drifter	1500	2001	2003	523351
VN 1500 F Classic	1500	1998	1999	523350
VN 1500 D Classic	1500	1996	1997	523350
VN 1600 A Classic	1600	2003	2008	523351
VN 1600 B Mean Streak	1600	2004	2008	523351
VN 1600 D Classic Tourer	1600	2005	2008	523351

KTM

250 EXC-F 4T	250	2008	2010	523360
250 EXC-F 4T Sixdays	250	2009	2010	523360
250 EXC-F ie 4T	250	2011	2011	523360
400 EXC	400	2009	2011	523360
450 EXC	450	2009	2011	523360
450 EXC R	450	2008	2008	523360
450 EXC Sixdays	450	2009	2011	523360
530 EXC Sixdays	525	2009	2011	523360
530 EXC	530	2009	2011	523360
530 EXC R	530	2008	2008	523360
620 EGS LC4	620	1994	2001	523361
640 Adventure LC4	640	2002	2007	523362
640 Duke II E	640	2002	2007	523362
640 LC4-E	640	2002	2006	523362
640 LC4-E Supermoto	640	2002	2006	523362
950 Adventure LC8	950	2003	2005	523363
950 Adventure S LC8	950	2003	2005	523363
950 Super Enduro R LC8	950	2006	2008	523363
950 Supermoto LC8	950	2006	2008	523363
950 Supermoto R LC8	950	2007	2008	523363

PIAGGIO

X10 125 4T 4V IE	125	2012	2015	523366
X10 350 4T 4V IE	350	2012	2015	523366
X10 500 IE EU3	500	2012	2014	523366

SUZUKI

VL 125 LC Intruder	125	2000	2008	523402
VL 125 LC U Intruder 80 Km/h	125	2000	2002	523402
GZ 125 Marauder	125	1998	2007	523398
VL 250 LC Intruder	250	2005	2007	523402
VL 250 INTRUDER	250	2000	2000	523403
GSF 400 Bandit	400	1991	1995	523378
GSXR 400	400	1990	1997	523395
GS 500 E	500	1990	1993	523371
GS 500 E	500	1994	1999	523372
GS 500	500	2001	2006	523370

Modèle	Cylindre	Année début	Année fin	Réf.
GS 500 F	500	2004	2006	523370
GS 500 FH	500	2007	2008	523370
GS 500 FM	500	2007	2008	523370
GS 500 FU	500	2004	2006	523370
GS 500 H	500	2007	2008	523370
GS 500 HU	500	2007	2008	523370
GS 500 U	500	2001	2006	523370
GSX 550 ES semie-carenée	550	1983	1983	523385
GS 550 T (ROUE BATON)	550	1981	1981	523373
GSX 600 F	600	1998	2001	523387
GSX 600 FU	600	1998	2001	523387
GSF 600 Bandit	600	2000	2004	523379
GSF 600 S Bandit	600	2000	2004	523379
GSF 600 SU Bandit	600	2000	2004	523379
GSF 600 U Bandit	600	2000	2004	523379
GSX 600 F	600	1990	1997	523386
GSX 600 FU	600	1990	1997	523386
GSX 600 FU2	600	1990	1997	523386
RF 600 R	600	1993	1996	523399
RF 600 RU	600	1993	1996	523399
GSF 600 S BANDIT	600	1996	1999	523380
GSX-R 600	600	1997	2000	523396
GSX 600 F KATANA	600	1988	1996	523388
VS 600 GL Intruder	600	1995	1997	523404
VS 600 GLU Intruder	600	1995	1997	523404
GSX 600 F KATANA	600	1998	2003	523389
SV 650 S	650	1999	2002	523401
SV 650 SU	650	1999	2002	523401
DR 650 RS	650	1990	1993	523368
DR 650 RSE	650	1990	1993	523368
SV 650	650	1999	2002	523400
DR 650 R	650	1992	1995	523367
DR 650 RE	650	1994	1995	523367
XF 650 Freewind	650	1997	2002	523407
XF 650 U Freewind	650	1997	2002	523407
GSX 750 F	750	1998	2002	523387
GSX 750 Inazuma	750	1998	2003	523392
GSX-R 750 W	750	1992	1995	523397
GSX 750 F	750	1989	1997	523391
GSX-R 750	750	1996	1997	523396
GSX 750 EF carenée	750	1984	1986	523390
GSX 750 ES semie-carenée	750	1983	1986	523390
GSX 750 F KATANA	750	1998	2003	523389
GSX 750	750	2004	2006	523389
VZ 800 Marauder	800	1997	2003	523406
VS 800 GL Intruder	800	1995	2000	523404

Modèle	Cylindre	Année début	Année fin	Réf.
GS 850 G	850	1979	1979	523374
GS 850 GT	850	1980	1981	523375
GS 850 GX	850	1980	1981	523375
GS 850 G	850	1980	1981	523373
GS 850 GL	850	1980	1981	523373
RF 900 R	900	1994	1997	523399
GS 1000 S Sport	1000	1979	1979	523374
GS 1000 E (ROUE BATON)	1000	1980	1980	523373
GS 1000 H (ROUE BATON)	1000	1980	1980	523373
GS 1000 (ROUE RAYON)	1000	1980	1980	523373
GSX-R 1100 W	1100	1993	1997	523394
GSX 1100 ET	1100	1979	1981	523375
GSX 1100 EX	1100	1979	1981	523375
GSX-R 1100	1100	1991	1992	523393
GSX 1100	1100	1984	1986	523381
GS 1100 G/Z	1100	1982	1984	523369
GSX 1100 G	1100	1991	1996	523383
GSX 1100 F	1100	1988	1996	523382
GSX 1100 (ROUE RAYON)	1100	1980	1981	523373
GSF 1200 Bandit	1200	1996	2000	523376
GSF 1200 S Bandit	1200	1996	2000	523376
GSF 1200 SA Bandit ABS	1200	1997	2000	523376
GSX 1200 Inazuma	1200	1999	2000	523384
GSF 1200 Bandit	1200	2001	2006	523377
GSF 1200 S Bandit	1200	2001	2005	523377
GSF 1200 SZ Bandit ABS	1200	2005	2005	523377
VSI400GL Intruder	1400	1990	2004	523405
S83 Boulevard	1400	2005	2009	523405
TRIUMPH				
Daytona 750	750	1992	1992	523409
Trident 900	900	1992	1998	523411
Trophy 900	900	1992	1993	523409
Trophy 900	900	1994	2001	523411
Thunderbird 900	900	1997	2000	523411
Legend 900 TT	900	1999	2001	523410
Trident 900	900	2003	2004	523411
Adventurer 900	900	1996	1997	523408
Thunderbird 900	900	1995	1996	523410
Thunderbird 900	900	2001	2002	523410
Tiger 900	900	1993	1998	523410
Daytona 900	900	1993	1996	523409
Daytona 900 Super III	900	1994	1996	523409
Speed Triple 900	900	1994	1996	523411
Adventurer 900	900	1998	2001	523410
Sprint 900	900	1993	1999	523411

Modèle	Cylindre	Année début	Année fin	Réf.
Sprint 900 Sport	900	1997	1999	523409
Daytona 1000	1000	1992	1992	523409
Trophy 1200	1200	1992	1993	523409
Trophy 1200	1200	1994	2003	523411
Daytona 1200	1200	1993	1997	523409
Rocket 2300 III	2300	2004	2004	523410
VESPA				
PX 125 E Lusso	125	1983	1995	523412
PX 125 E Lusso starter électrique	125	1984	1998	523412
PX 125 T5	125	1985	1990	523412
PK 125 XL allumage électronique	125	1986	1990	523413
PK 125 XL2	125	1990	1993	523413
P 150 X	150	1978	1981	523412
PX 150 E	150	1981	1985	523412
PX 150 E Lusso	150	1983	1990	523412
P 200 E	200	1977	1982	523412
PX 200 E	200	1982	1986	523412
PX 200 E GS Grand Sport	200	1988	1995	523412
PX 200 E GS Grand Sport starter électrique	200	1988	1998	523412
PX 200 E Lusso	200	1983	1995	523412
PX 200 E Lusso starter électrique	200	1984	1995	523412
YAMAHA				
XT 225	225	2002	2007	523427
XV 250 S Virago	250	1995	2000	523430
XV 250 VIRAGO	250	1997	2001	523431
XV 500 SE Special	500	1983	1984	523432
XJ 550	550	1981	1984	523421
XT 550	550	1982	1982	523428
XT 550 K	550	1983	1983	523428
XZ 550 /S	550	1982	1984	523432
YZF 600 RH Thunder Cat	600	1996	2002	523435
YZF 600 RN Thunder Cat	600	1996	2002	523435
SRX 600 H	600	1986	1989	523417
SRX 600 N	600	1986	1989	523417
SRX 600	600	1987	1987	523417
XJ 600 NH	600	1994	2003	523423
XJ 600 NN	600	1994	2003	523423
XJ 600 SH Diversion	600	1996	2003	523423
XJ 600 SN Diversion	600	1996	2003	523423
FZS 600 FAZER	600	1998	2001	523415
XJ 600 N	600	1984	1989	523422
XJ 600 H	600	1984	1988	523422
YZF-R6	600	1999	2002	523436

Modèle	Cylindre	Année début	Année fin	Réf.
XJ 650 H	650	1980	1985	523424
XJ 650 N	650	1982	1985	523424
XTZ 750 Super Tenere	750	1989	1995	523429
XV 750 SE Special	750	1981	1984	523433
TDM 850 H	850	1991	1996	523418
TDM 850 N	850	1991	1993	523418
TRX 850	850	1996	1999	523419
XJ 900	900	1983	1986	523425
XJ 900 F	900	1985	1989	523425
FZS 1000 Fazer	1000	2001	2005	523414
FZS 1000 S Fazer	1000	2003	2005	523414
V-STAR 1100 Classic	1100	2000	2002	523420
V-STAR 1100 Custom	1100	2000	2003	523420
V Star 1100 Classic - (ROUE BATON)	1100	2003	2003	523420
V Star 1100 Classic	1100	2008	2009	523420

Modèle	Cylindre	Année début	Année fin	Réf.
V Star 1100 Silverado D (ROUE BATON)	1100	2003	2003	523420
V Star 1100 Classic	1100	2004	2007	523420
V Star 1100 Custom	1100	2004	2009	523420
V Star 1100 Silverado	1100	2004	2007	523420
V Star 1100 Midnight Custom	1100	2006	2009	523420
V Star 1100 Silverado	1100	2008	2009	523420
V Star 1100 Midnight Custom	1100	2005	2005	523420
FJ 1100	1100	1984	1985	523425
XJR 1200	1200	1996	1998	523426
XJR 1200 SP	1200	1997	1998	523426
XJR 1300	1300	1999	2000	523426
XJR 1300 SP	1300	1999	2001	523426
XVZ 1300 Venture Royale	1300	1990	1993	523434



/ POIGNEE D'EMBRAYAGE

Désignation	RIEJU	BLACKWAY
POIGNEE / LEVIER EMBRAYAGE MECABOITE OEM RIEJU MRT 2018-> EURO4 (0 / 000.830.8304) COMPLET	504241	
POIGNEE / LEVIER EMBRAYAGE MECABOITE OEM RIEJU MRT / MRT PRO / SMX / TANGO ->2018 (0 / 000.830.5001)	504242	
POIGNEE / LEVIER EMBRAYAGE MOTO BLACKWAY UNIVERSEL ARGENT LEVIER ARGENT		511982
POIGNEE / LEVIER EMBRAYAGE MOTO BLACKWAY UNIVERSEL NOIR LEVIER ARGENT		511981

/ CABLE D'EMBRAYAGE

Modèle	Cylindre	Année début	Année fin	Réf.
APRILIA				
RS 125 Replica	125	1995	2005	527350
RS 125	125	1995	2010	514656
RS 125	125	1995	2010	527256
RS 250	250	1998	2002	514859
RXV 450	450	2006	2015	514950
RXV 550	550	2006	2013	514950
Pegaso 650 ie	650	2001	2004	514798
Pegaso 650	650	1997	2000	514778
Pegaso 650 R	650	1994	1994	514778
Pegaso 650 S	650	1995	1995	514778
Pegaso Strada-Trail ie 650	650	2005	2007	514854

Modèle	Cylindre	Année début	Année fin	Réf.
BENELLI				
125 S	125	0	0	527177
TNT 125	125	2017	2017	527174
BN 125	125	0	0	527178
TRK 251 ABS	250	0	0	527176
BN-251	251	0	0	527172
LEONCINO 500	500	2017	2017	527175
TRK 502	502	0	0	527173
TNT 600	600	2014	2019	527205
BMW				
R 25	250	1951	1956	514934
R 26	250	1956	1959	514936

Modèle	Cylindre	Année début	Année fin	Réf.
R 27	250	1961	1965	514936
G 450 X	450	2008	2010	514827
R 50/2	500	1968	1970	514933
R 50/5	500	1969	1973	515000
R 51	500	1951	1953	515005
R 50/2	500	1968	1970	514932
R 50/5	500	1969	1973	515001
R 60/2	600	1967	1970	514933
R 69 S	600	1967	1970	514933
R 60	600	1977	1978	514986
R 60/6	600	1974	1976	514986
R 67	600	1951	1955	515005
R 68	600	1952	1954	515005
R 60/2	600	1967	1970	514932
R 69 S	600	1967	1970	514932
R 60/5	600	1969	1973	515001
R 60/7	600	1976	1980	527370
R 60	600	1977	1978	514983
R 60	600	1977	1978	514988
R 60/6	600	1974	1976	514983
R 65	650	1979	1985	514987
R 65 LS	650	1981	1985	514987
F 650 GS	650	2000	2007	514995
F 650 CS	650	2001	2005	514995
F 650 GS Dakar	650	2000	2007	514995
G 650 GS	650	2008	2010	514995
R 65 3Serie (monolevier)	650	1993	1993	514810
R 65 GS	650	1987	1992	514810
G 650 GS	650	2011	2016	515002
G 650 GS Sertão	650	2012	2014	515002
F 650	650	1997	2000	514989
F 650 ST	650	1997	1997	514989
F 650 GS	650	2008	2012	514935
G 650 Xmoto	650	2007	2007	514977
F 650 GS	650	2008	2012	514991
F 650 GS ABS	650	2008	2012	514991
G 650 Xcountry	650	2007	2008	514977
G 650 Xchallenge	650	2007	2007	514977
F 700 GS ABS	700	2013	2014	514991
K 75	740	1986	1995	514996
K 75	740	1986	1995	514994
R 75	750	1977	1977	514986
R 75/6	750	1974	1976	514986
R 75/5	750	1969	1973	515001
R 75/7	750	1976	1979	527370
R 75	750	1977	1977	514983

Modèle	Cylindre	Année début	Année fin	Réf.
R 75/6	750	1974	1976	514983
R 75	750	1977	1977	514988
R 80/7	800	1978	1980	514986
F 800 GT	800	2012	2016	514965
F 800 GT	800	2018	2018	514965
F 800 R	800	2009	2018	514965
R 80/7 N	800	1977	1980	527370
R 80/7 S	800	1977	1980	527370
R 80 R	800	1991	1994	527370
R 80 R Mystic	800	1994	1994	527370
F 800 R	800	2010	2013	527369
R 80 GS (monolevier)	800	1980	1987	514810
R 80 GS PD Paris Dakar (monolevier)	800	1984	1987	514810
R 80 GS paralever	800	1987	1990	514810
R 80 GS PD Paris Dakar paralever	800	1990	1993	514810
R 80 GS/2 Last Edition paralever	800	1996	1998	514810
R 80 GS/2 paralever	800	1990	1995	514810
R 80 RT	800	1982	1984	514810
R 80/7	800	1978	1980	514983
R 80	800	1983	1987	514988
F 800 ST	800	2007	2012	515011
F 800 GS	800	2008	2012	514967
F 800 GS ABS	800	2008	2012	514967
F 800 GS ABS	800	2013	2014	514991
F 800 GS Adventure ABS	800	2013	2014	514991
F 800 S	800	2006	2010	515015
R 850 GS	850	1998	1999	514997
R 850 GS ABS	850	1998	1999	514997
R 850 R ABS (ROUE BATON)	850	1998	2002	514997
R 850 R ABS	850	1998	2002	514997
R 850 R ABS S(ROUE RAYON)	850	1998	2002	514997
R 850 R ABS (ROUE RAYON)	850	1998	2002	514997
R 850 R (ROUE BATON)	850	1995	2002	514997
R 850 R	850	1995	2002	514997
R 850 R S(ROUE RAYON)	850	1995	2002	514997
R 850 R (ROUE RAYON)	850	1995	2002	514997
F 850 GS	850	2019	2021	527211
R 90/6	900	1974	1976	514986
R 90/5	900	1973	1976	515000
R 90/6	900	1974	1976	514983
R 90 S	900	1974	1976	514983
S 1000 XR	1000	2015	2019	527213
R 100 RS	1000	1988	1988	514985
R 100 RS	1000	1992	1992	514985

MOTEUR

CYCLE

PNEUMATIQUE

ATELIER

ACCESSOIRES

ÉLECTRICITÉ

FILTRATION

FREINAGE

TRANSMISSION

Modèle	Cylindre	Année début	Année fin	Réf.
R 100/7T	1000	1977	1978	514986
R 100 R	1000	1992	1994	514986
R 100 R Mystik	1000	1994	1995	514986
K 100 LT	1000	1987	1991	514994
K 100 RT	1000	1984	1988	514994
K 100	1000	1985	1986	514994
HP4	1000	2012	2015	514966
HP4 Race	1000	2017	2018	514966
S 1000 RR	1000	2009	2019	514966
K1	1000	1990	1992	514996
K 100 RS	1000	1984	1992	514996
R 100 T	1000	1979	1984	514986
S 1000 R	1000	2013	2017	514946
R 100/7	1000	1976	1978	527370
R 100 R Roadster	1000	1991	1993	527370
R 100 R Roadster Classic	1000	1994	1996	527370
R 100 RT/2 Classic (monolevier)	1000	1994	1996	514810
R 100 RT/2 (monolevier)	1000	1987	1993	514810
R 100/7T	1000	1977	1978	514983
R 100 CS	1000	1981	1981	514983
R 100 RS	1000	1979	1984	514983
R 100 S	1000	1977	1980	514983
R 100 T	1000	1979	1984	514983
R 100/7T	1000	1977	1978	514988
R 100 GS	1000	1988	1995	514988
R 100 RT	1000	1978	1984	514988
R 100 RT	1000	1988	1996	514988
R 100 T	1000	1979	1984	514988
K 1100 LT	1100	1992	1997	514994
R 1100 GS ABS	1100	1993	1999	514997
R 1100 R ABS S(ROUE RAYON)	1100	1998	2001	514997
R 1100 R ABS (ROUE RAYON)	1100	1995	2001	514997
R 1100 R S(ROUE RAYON)	1100	1998	2001	514997
R 1100 R (ROUE RAYON)	1100	1995	2001	514997
R 1100 RT ABS (ROUE BATON)	1100	1996	2001	514997
K 1100 RS	1100	1993	1996	514996
R 1100 GS	1100	1994	1999	514997
R 1100 RS	1100	1992	2001	514984
CAGIVA				
Mito 125	125	0	0	527254
Raptor 125	125	0	0	527258
Planet 125	125	0	0	527258
HONDA				
MSX 125	125	2017	2018	527217
MSX 125	125	2013	2016	527215

Modèle	Cylindre	Année début	Année fin	Réf.
CBF 125 M	125	2009	2012	527367
MSX 125	125	2019	2020	527216
CR 125 M	125	1976	1978	514691
CBR 125 R	125	2012	2012	527368
CBR 125 RT	125	2012	2012	527368
CBR 125 RW	125	2011	2011	527368
CBR 125 RS Repsol	125	2012	2012	527368
CB 125 J	125	1975	1979	527244
CG 125	125	1995	1999	527344
CBR 125 R	125	2004	2005	527365
CBR 125 RW	125	2005	2006	527365
CBR 125 RS Repsol	125	2005	2007	527365
CB 125 S	125	1976	1980	514607
CG 125 W	125	1998	1998	514617
XL 125 S	125	1979	1984	514627
CB 125 S	125	1981	1982	514627
CB 125 K	125	1972	1975	527261
VT 125 C Shadow	125	1999	2008	527298
CB 125 T	125	1978	1982	527240
CB 125 T Twin	125	1980	1986	514614
CB 125 T2 Twin	125	1979	1986	514614
CB 125 TD	125	1982	1982	514614
XL 125 V Varadero	125	2001	2003	514768
CA 125 Rebel	125	1995	2000	514666
CB 125 F	125	2015	2020	527207
XL 125	125	1977	1978	514620
XL 125 R	125	1979	1984	514620
CBR 125 RW	125	2009	2010	514581
CG 125 MI	125	2001	2003	527237
CG 125 ES	125	0	0	527166
CR 125	125	2004	2007	514905
XL 125 Varadero	125	2004	2010	514677
CB 175	175	1974	1976	514740
XL 185 S	185	1981	1983	514627
XR 185	185	1979	1979	514627
XL 200 R	200	1983	1984	514627
XR 200	200	1981	1984	514627
CB 200	200	0	0	527338
TW 200	200	2001	2021	514852
XL 200	200	2005	0	527179
XT 225	225	1992	1993	514852
CRF 250 L	250	2013	2016	514711
CB 250 K	250	0	0	514893
CRF 250 R	250	2010	2013	527249
XL 250	250	1976	1976	514691
CBF 250	250	2004	2006	514719

Modèle	Cylindre	Année début	Année fin	Réf.
CL 250 S Scrambler	250	1982	1983	527325
XL 250 R	250	1984	1988	527325
CRF 250 R	250	2004	2007	527248
CB 250 T Twin	250	1977	1978	514624
CRF 250 R	250	2008	2009	514971
NX 250	250	1988	1995	514807
XL 250 S	250	1978	1982	514646
CB 250 T Twin	250	1977	1978	514584
CR 250 R	250	2004	2007	514904
CB 250 RS	250	1980	1981	514614
CB 250 RSZ	250	1982	1984	514614
CMX 250 C Rebel	250	1997	1999	514666
CB 250 Two-Fifty	250	1996	1998	514588
CBR 250 R	250	2011	2015	527167
VTR 250 MC33	250	2009	2009	527301
XL 250 S	250	1979	1983	514690
CB 350 K	350	0	0	514893
XL 350	350	1976	1978	514691
XL 350 R	350	1985	1988	514961
CB 350 F	350	1972	1974	514641
CB 350 Super Sport	350	1968	1973	514705
CL 350	350	1968	1973	527337
CB 350 G Super Sport Disc Brakes	350	1973	1973	514705
CB 350 G	350	1973	1973	527337
CB 350 K	350	1973	1973	527337
CB 400 N Euro	400	1978	1980	514604
CB 400 F Four	400	1974	1977	514839
CB 400 T	400	1977	1978	514624
CB 400 T	400	1977	1978	514584
RVF 400 NC35	400	1994	1997	514784
CBR 400 RR Nc23	400	1986	1991	514799
CB 400 N Euro	400	1981	1985	514579
NS 400 R	400	1985	1986	514611
VFR 400 NC30	400	1991	1992	514944
XR 400 R	400	1997	2004	514805
CRF 450 R	450	2009	2012	527249
CRF 450 R	450	2004	2008	515013
CRF 450 R	450	2002	2003	514970
CMX 450 Rebel C	450	1986	1987	514608
CB 450 S	450	1986	1989	514689
CB 450 N	450	1985	1985	514579
CL 450	450	1969	1973	527337
CB 450 K	450	1968	1974	527337
CX 500	500	1980	1981	527268
VT 500 C Shadow	500	1983	1984	514643

Modèle	Cylindre	Année début	Année fin	Réf.
XBR 500 (ROUE BATON)	500	1985	1987	514809
XBR 500 S (ROUE RAYON)	500	1987	1989	514809
VT 500 E	500	1983	1984	514644
CX 500 E Euro Sports	500	1982	1986	514605
CX 500 C	500	1980	1981	514613
GL 500 D Silverwing	500	1982	1983	514613
CX 500	500	1977	1979	514624
XL 500 R Pro Link	500	1982	1985	514646
XL 500 S	500	1979	1982	514646
CX 500	500	1977	1979	514584
CB 500 T	500	1975	1976	514653
CB 500 S Sport	500	1998	2003	527296
CX 500	500	1982	1983	527290
CB 500 T Twin	500	1975	1976	527337
CB 500 K Four	500	1972	1977	527222
CB 500 F	500	2013	2018	527341
CBR 500 R	500	2013	2018	527341
XL 500 S	500	1979	1981	514690
CBF 500	500	2004	2007	514741
CBF 500	500	2008	2011	527184
CB 500	500	1994	2003	514779
CB 500 S Sport	500	1998	2003	514779
CBX 550 F Supersport	550	1982	1984	527220
CBX 550 F2 Supersport	550	1982	1984	527220
CB 550 K Four	550	1977	1978	527221
CBF 600	600	2004	2007	527356
CBR 600 RR	600	2009	2020	527202
CBR 600 F	600	1991	1998	514684
XL 600 R	600	1983	1987	514592
CBR 600 RR	600	2007	2008	514680
CB 600 F Hornet	600	2007	2010	527366
CB 600 FA Hornet ABS	600	2007	2012	527366
CB 600 F Hornet	600	1998	2001	514914
CB 600 S F2 Hornet S	600	2000	2001	514914
VT 600 C Shadow	600	1993	1997	514756
XL 600 RM	600	1986	1986	514824
XL 600 LM Paris Dakar	600	1985	1987	514824
XL 600 V Transalp	600	1987	2000	514701
CBR 600 F	600	1999	2000	514712
VT 600 C Shadow	600	1989	1992	514721
XR 600 R	600	1992	1998	527206
CBR 600 RR A	600	2003	2006	514678
CBR 600 RR AC	600	2003	2006	514678
NTV 600	600	1988	1992	514716
CBR 600	600	1991	1997	527259
CBF 600 S	600	2008	2009	527317

Modèle	Cylindre	Année début	Année fin	Réf.
CB 600 F Hornet	600	2002	2006	514861
VT 600 C Shadow	600	1993	1997	527281
CBR 600 F	600	1987	1990	514749
CB 650	650	1979	1982	514704
NTV 650 Revere	650	1988	1997	514836
FMX 650	650	2005	2006	514683
NX 650 Dominator	650	1993	1996	527283
GL 650 D Silverwing	650	1983	1983	514613
CB 650 C Custom	650	1980	1981	514766
XL 650 V Transalp	650	2000	2007	514806
NT 650 V Deauville	650	1998	2001	514640
NT 650 V Deauville CBS	650	2002	2005	514640
NTV 650	650	1993	1997	514716
SLR 650	650	0	0	527306
FX 650 Vigor	650	0	0	527306
XR 650	650	2000	2003	527307
CB 650 F	650	2014	2016	527203
CB 650 F ABS	650	2014	2016	527203
NT 700 V Deauville	700	2006	2013	514726
NT 700 VA Deauville ABS	700	2006	2016	514726
NC 700 S	700	2012	2013	514883
XL 700 V Transalp	700	2008	2013	514652
NC 700 X	700	2012	2015	527348
CB 750 K Four	750	1969	1976	514704
CB 750 K Four	750	1969	1976	514593
XRV 750 Africa Twin	750	1993	2003	527282
CB 750 F2 Seven Fifty	750	1992	2003	514589
CB 750 K Four	750	1969	1976	527336
CB 750 F	750	1980	1982	514723
CB 750 F2	750	1982	1982	514723
CB 750 S	750	1982	1983	514657
CB 750 L	750	1979	1979	514657
CB 750 K	750	1979	1982	514657
VT750C Shadow Aero	750	2004	2007	514622
CB 750 Bol dor F	750	1980	1982	514650
CB 750 C	750	1980	1982	514657
XLV 750 R	750	1983	1985	527324
VT 750 C Shadow	750	1997	2000	514638
VT 750 C2 Shadow Aero	750	1997	2002	514638
VF 750 C Magna	750	1993	2000	514794
XRV 750 Africa Twin	750	1990	1992	514931
VT 750 C2 Shadow Spirit	750	2007	2014	527201
VT 750 DC Shadow Spirit	750	2001	2007	527200
VT 750 C	750	2008	2009	527197
VT 750 CA	750	2008	2009	527197
CB 750 F2 Seven Fifty	750	1992	2003	527293

Modèle	Cylindre	Année début	Année fin	Réf.
NC 750 X	750	2012	2015	527348
XLV 750 R	750	1983	1985	514855
CBR 900 RR	900	2002	2003	514686
CBR 900 RR	900	2000	2001	514792
CB 900 F Bol d'Or	900	1979	1983	514609
CB 900 F Hornet	900	2002	2006	527309
CBR 900 RR	900	1992	1997	514703
CB 900 F	900	1981	1982	514657
CB 900 C	900	1980	1982	514657
CBR 900 RR	900	1998	1999	514729
CBR 900 RR	900	1993	1995	527262
CBR 900 RR	900	1996	1997	514804
CBR 1000 RR	1000	2008	2013	514628
CBR 1000 RR	1000	2014	2016	527218
CBR 1000 S	1000	2016	2016	527218
GL 1000 K Goldwing	1000	1975	1976	514999
XL 1000 V Varadero	1000	2006	2010	514679
CBX 1000	1000	1979	1980	514655
XL 1000 VA Varadero ABS	1000	2004	2013	514679
CBX 1000 Pro Link	1000	1981	1983	514655
GL 1000 K Goldwing	1000	1977	1979	514911
GL 1000 GoldWing	1000	1975	1980	527300
CRF 1000 L AFRICA TWIN	1000	2016	2019	527210
CB 1100 F	1100	1983	1983	527345
CB 1100 R	1100	1981	1982	514609
VT 1100 C2 Shadow ACE	1100	1995	1998	527225
GL 1100 Goldwing	1100	1980	1981	514731
GL 1100 D Goldwing faring	1100	1980	1981	514731
VT 1100 Shadow ACE C2	1100	2000	2007	527247
VT 1100 C3 Shadow Aero	1100	1998	2000	514637
VTX 1300	1300	2007	2007	527189
HUSQVARNA				
Husqvarna CR 125	125	2009	2014	527352
Husqvarna WR 125	125	2009	2014	527352
CR 250	250	1999	2005	527353
WR 250	250	1999	2007	527353
HYOSUNG				
RX 125	125	0	0	514864
XRX 125	125	0	0	514864
GA 125	125	0	0	514865
GV 125	125	0	0	514892
RT 125	125	0	0	527245
GV 250	250	0	0	514892
GT 250 R	250	2004	2009	527182
GT 650 R	650	0	0	527246

Modèle	Cylindre	Année début	Année fin	Réf.
GV 650	650	2004	0	527181
GT 650	650	0	0	527190
GV 650 ENJ.	650	0	0	527170
GF 125	125	0	0	514828
GT 250	250	0	0	527188

KAWASAKI

KX 125	125	2000	2002	514844
KMX 125	125	0	0	527287
KX 125	125	2003	2003	527303
KX 125	125	1999	1999	527302
KLX 150	150	2014	2014	527171
KE 175 BI-B4	175	0	0	514662
KMX 200	200	0	0	527287
EL 250 D	250	1990	1995	527346
KX 250 F 4T	250	2004	2008	515022
EX 250 R	250	2008	2012	527186
KH 250 B	250	1976	1980	514894
F11 250	250	1971	1975	527343
KX 250 F 4T	250	2009	2012	514901
KLR 250 D	250	1984	1992	514585
A1 250 Samurai A7 Avenger	250	1970	1970	514782
Z250 TWIN	250	0	0	527273
ER 250	250	0	0	527277
KX 250	250	1999	2004	514845
Z 250 G Ltd	250	1982	1984	514881
KX-F 250	250	2004	2008	527304
KX 250	250	2005	2008	514906
EX 300 R	300	2013	2015	527186
GPZ 305	305	0	0	527277
GPZ 400 A	400	1985	1985	514709
KH 400 A	400	1976	1978	514894
Z 400 J	400	1980	1983	514843
ZXR 400 L	400	1991	1999	514649
Z 400 J1/J2/J3	400	0	0	514829
Z400 TWIN	400	0	0	527273
Z 400 D	400	1974	1977	527333
VN 400 Vulcan	400	1995	1998	527193
ZRX 400	400	1994	2005	527271
ZZR 400	400	1990	1992	527271
Z 400 M GP	400	1983	1983	527332
Z 440 A Ltd	440	1982	1983	514599
Z 440 D Ltd Belt Drive	440	1984	1984	514599
Z 440 D Ltd Belt Drive	440	1982	1983	527326
KX 450 F	450	2006	2008	514948
KX 450 F	450	2009	2014	514949

Modèle	Cylindre	Année début	Année fin	Réf.
EN 450 A Ltd	450	1985	1989	514759
Z440 TWIN	450	0	0	527273
EN 500 A	500	1990	1993	514781
EN 500 C	500	1996	2003	514858
KLE 500 A	500	1991	2004	514667
Z 500 B	500	1979	1980	514843
ER 500 A Twister	500	1997	2000	514632
ER 500 B Twister	500	1997	2000	514632
GPZ 500 S	500	1987	2003	514632
H1 Mach3	500	1969	1969	515018
H1	500	1970	1975	515018
KH500	500	1976	1976	515018
Z 500 B1/B2	500	0	0	514829
KH 500 Mach 3	500	1969	1977	514978
KLE 500	500	2005	2007	527347
ZZR 500	500	1990	1992	527271
ZR 550 B Zephyr	550	1991	1999	514789
GPZ 550 A Uni Trak	550	1984	1989	514709
Z 550 B	550	1981	1982	514843
Z 550 D GP	550	1981	1981	514843
Z 550 A1/A2/A3	550	0	0	514829
GT550 G1-G6	550	0	0	527314
Z 550 H GP	550	1982	1983	527332
ZR 550 A	550	1983	1983	527332
ZX-6RR 600 N Ninja	600	2005	2006	514634
ZX-6R 600 F Ninja	600	1995	1997	514633
ZX-6R 600 G Ninja	600	1998	1999	514633
ZX-6R 600 H Ninja catalyst	600	1998	1999	514633
ZX-6R 600 J Ninja	600	2000	2002	514633
KLR 600 A	600	1984	1984	514590
GPX 600 R	600	1988	1996	514610
KLR 600 B	600	1985	1989	514590
ER-6n	600	2009	2010	514927
GPZ 600 R Ninja	600	1985	1990	514842
ZL 600	600	1986	1987	514718
ZX-6RR 600 K Ninja	600	2003	2003	527280
ZX-6RR 600 M Ninja	600	2004	2004	527280
Ninja ZX-6R	600	1999	2002	527236
ZZR600	600	2005	2006	527236
ZZR 600 D	600	1990	1992	514837
ZZR 600 E	600	1993	2006	527289
GPZ 600 R	600	0	0	527277
Ninja ZX-6R	600	2007	2008	514717
Ninja 600	600	1990	1993	527271
ZX-6R 636 C Ninja	636	2005	2006	514634
ZX-6R 636 A Ninja	636	2002	2002	514633

Modèle	Cylindre	Année début	Année fin	Réf.
ZX-6R 636 B Ninja	636	2003	2004	527280
KLX 650	650	1993	1996	527349
Ninja 650R	650	2009	2011	514927
Z 650 SR	650	1979	1980	514953
KLE 650 Versys	650	2011	2014	514998
Z 650 B	650	1977	1980	514954
Z 650 C	650	1978	1980	514954
Z 650 F	650	1981	1983	514954
KLE 650	650	2008	2010	514952
ER6 N	650	2012	2016	527340
ER6 F	650	2012	2016	527340
W 650 A guidont haut	650	1999	2002	514606
KLR 650 C	650	1995	2004	527295
ER-6F 650 A	650	2006	2007	527299
ER-6F 650 B ABS	650	2006	2008	527299
ER-6N 650 A	650	2005	2007	527299
ER-6N 650 B ABS	650	2005	2008	527299
Z 750 M ABS	750	2007	2010	514694
Z 750 H Ltd 4 cylindres	750	1980	1982	514875
H2 750 Mach 4	750	1972	1972	515021
H2 750 A Mach 4	750	1973	1973	515021
ZR 750 C Zephyr	750	1991	1995	514645
ZR 750 D Zephyr	750	1996	1999	514645
Z 750 GP	750	1982	1982	527312
Z 750 GP Uni Trak	750	1983	1984	527312
Z 750 L	750	1983	1984	527312
Z 750 E	750	1980	1980	514954
Z 750 L	750	1981	1982	514954
GPZ 750 A Uni Trak	750	1985	1985	514764
ZX 750 E Turbo	750	1984	1985	514764
VN 800 A	800	1995	1999	527223
VN 800 B Classic	800	1996	2005	514886
VN 800 B Classic	800	1996	2005	527266
VN800	800	1995	2006	527193
Z 800	800	2013	2016	515129
Z 800 E	800	2013	2016	515129
Z 800 ABS	800	2013	2016	515129
ZX-9R 900 C Ninja	900	1998	1999	514633
ZX-9R 900 D Ninja catalyst	900	1998	1999	514633
VN 900 B Classic	900	2006	2015	514899
VN 900 B Classic Special Ed.	900	2011	2015	514899
VN 900 C Custom	900	2015	2015	514899
Z 900 A	900	1976	1976	527224
Z1 900	900	1973	1973	527224
Z1A 900	900	1974	1974	527224
Z1B 900	900	1975	1975	527224

Modèle	Cylindre	Année début	Année fin	Réf.
ZX-9R 900 E Ninja	900	2000	2001	514692
ZX-9R 900 F Ninja	900	2002	2003	514942
Vulcan 900 Custom (European)	900	2007	2009	527194
VN 900 Custom	900	2007	2020	527194
Z 1000 K Ltd	1000	1981	1981	527319
Z 1000 A	1000	2003	2006	514694
Z 1000 B	1000	2007	2009	514694
Z 1000 C ABS	1000	2007	2009	514694
Z 1000 ABS	1000	2014	2016	527208
Versys 1000 LT	1000	2015	2015	527208
Z 1000 A	1000	1977	1977	527224
Z 1000 R2	1000	1983	1983	527312
Z 1000 ST	1000	1979	1980	514868
ZX-10R 1000 D Ninja	1000	2006	2007	514675
Ninja ZX-10R	1000	2004	2005	527274
Z 1000 J	1000	1981	1982	527264
Z 1000 J	1000	1981	1982	515004
ZX-10R 1000 E Ninja	1000	2008	2009	514682
ZX-10R 1000 F Ninja	1000	2010	2010	514682
Z 1000 MK2	1000	1979	1980	527292
Z 1000 H Injection	1000	1980	1980	527292
Z1R 1000 D	1000	1978	1980	527292
ZX-10R 1000 C Ninja	1000	2005	2005	514945
ZX-10R	1000	2006	2007	527275
ZX-10R	1000	2008	2010	527276
GPZ 1100 A Uni Trak	1100	1983	1985	514979
GPZ 1100 B	1100	1982	1982	527312
GPZ 1100 B	1100	1981	1981	527264
GPZ 1100 B	1100	1981	1981	515004
Z 1100 ST	1100	1981	1983	514912
ZX-12R 1200 A Ninja	1200	2000	2001	514713
ZX-12R 1200 B Ninja	1200	2002	2006	514713
Z 1300	1300	1979	1982	514654
Z 1300 A	1300	1979	1983	514707
Voyager ZNI300	1300	1983	1988	514923
KEEWAY				
SUPERSHADOW 250	250	0	0	527183
CRUISER 250	250	0	0	527168
KTM				
125 Duke	125	2011	2012	514956
125 Duke ABS	125	2013	2016	514956
125 LC2	125	1996	2000	514880
125 EGS (D)	125	1994	1995	514896
125 EGS M (USA)	125	1996	1996	514896
125 EXC (E)	125	1994	1994	514896

Modèle	Cylindre	Année début	Année fin	Réf.
125 EXC Marz (I)	125	1994	1994	514896
125 EXC Marz/HL (USA)	125	1995	1995	514896
125 SX Marz/HL	125	1995	1995	514896
DUKE 200	200	2020	2022	527219
200 Duke	200	2012	2012	514956
200 Duke ABS	200	2013	2016	514956
250 EGS M (D)	250	1994	1997	514896
250 EGS (D)	250	1998	1998	514896
250 SX M	250	1994	1994	514896
250 EXC (USA)	250	1995	1995	514896
250 EXC M 13LT (USA)	250	1997	1997	514896
250 EXC 12LT (USA)	250	1998	1998	514896
250 MXC (USA)	250	1998	1998	514896
250 MXC (USA)	250	1998	1998	514896
250 SX	250	1998	1998	514896
300 EGS	300	1994	1998	514896
300 MXC	300	1994	1998	514896
300 SX M	300	1994	1994	514896
300 EXC Marz/HL (USA)	300	1995	1995	514896
300 EXC M 13LT (USA)	300	1996	1996	514896
300 EXC M 13LT (USA)	300	1997	1997	514896
300 EXC 12LT (USA)	300	1998	1998	514896
360 EGS M 18KW 13LT (AUS)	360	1996	1996	514896
360 EGS M 17.5KW (EU-DIV)	360	1997	1997	514896
360 MXC	360	1996	1996	514896
360 MXC M 13LT (USA)	360	1997	1997	514896
360 SX	360	1996	1996	514896
360 EXC M 13LT (USA)	360	1996	1996	514896
380 EXC 12LT (USA)	380	1998	1998	514896
380 SX	380	1998	1998	514896
400 LC4-E	400	2000	2001	514968
400 DUKE	400	1994	1994	515019
440 EXC	440	1994	1995	514896
440 EXC Marz HL	440	1995	1995	514896
440 MXC (USA)	440	1994	1994	514896
440 SX	440	1994	1994	514896
550 MXC M	550	1994	1994	514896
620 EGS LC4	620	1995	1998	514880
620 SC LC4 Super Competition	620	2000	2001	514968
620 SC LC4 Supermoto	620	2000	2001	514968
620 DUKE	620	1996	1998	515019
625 SC LC4 Super Competition	625	2002	2002	514968
625 SC LC4 Super Competition Supermoto	625	2002	2002	514968
640 Adventure LC4	640	2001	2002	514968

Modèle	Cylindre	Année début	Année fin	Réf.
640 Adventure R	640	1999	2000	514968
640 Duke II E	640	1999	2002	514968
640 LC4-E	640	2000	2002	514968
640 LC4-E Supermoto	640	2000	2002	514968
MOTO GUZZI				
Le Mans MK1 / MK2 / MK3	850	0	0	527318
Le Mans MK1 / MK2 / MK3	1000	0	0	527318
SUZUKI				
RV 125 Van Van	125	2003	2014	514785
RM 125	125	2004	2012	514900
RM 125	125	1993	1993	527267
RM 125	125	1995	1997	527267
RM 125 S	125	1992	1995	527267
DR 125 S	125	1986	1994	514874
DR 125 SE, SEU	125	1997	2000	514874
GT 125	125	1974	1979	514708
GT 125 E	125	1978	1979	514708
RV 125 Van Van	125	1973	1981	514580
GP 125	125	1978	1989	514659
RM 125	125	1998	2000	514797
VL 125 LC Intruder	125	2000	2008	514621
TS 125	125	0	0	527286
GN 125 ET	125	1991	1996	514863
GN 125 EV	125	1997	1997	514863
GN 125 Z	125	1983	1983	514863
VL 125	125	2000	2004	527255
GZ 125 Maraude	125	1998	2011	514825
TS 125 R	125	1990	1995	527316
GZ 125 Marauder	125	1998	2011	514825
GS 125 Disc	125	1982	1999	527272
EN 125	125	2003	2009	527315
GT 185	185	1973	1976	527357
TS 185	185	1979	1980	514647
TS 200 R	200	1990	1995	527316
GT 200 X5	200	0	0	514662
RM 250	250	2004	2012	514900
RM-Z 250	250	2007	2009	514972
RM 250	250	1993	1993	527267
RM 250	250	1995	1995	527267
GSX 250	250	1980	1981	514847
RM 250 S	250	1993	1995	527267
GSX 250 E	250	1980	1983	514847
GSX 250 EU	250	1980	1981	514847
GSX 250 U	250	1980	1981	514847
RM 250	250	1998	2000	514797

Modèle	Cylindre	Année début	Année fin	Réf.
GW 250 INAZUMA	250	2012	2017	527198
VL 250 LC Intruder	250	2005	2007	514621
GT 250	250	1973	1977	514623
T 250	250	1969	1970	514623
T 250 Hustler	250	1971	1972	514623
TS 250 Savage	250	1969	1975	514623
RM-Z 250	250	2010	2012	514990
VL 250 INTRUDER	250	0	0	527185
GN 250	250	1985	1999	527327
GNX 250 E	250	1982	1984	527327
GT 250 X7	250	0	0	514662
T 305	305	1968	1968	514623
DR 350	350	1990	1995	527321
DR 350 S	350	1990	1993	527321
DR 350 SH	350	1992	1993	527321
T 350 Rebel	350	1971	1972	514623
TC 350 Rebel	350	1969	1970	514623
DR 350 S	350	1994	1994	514582
DR 350 SE	350	1994	1997	514582
DR 350 SH	350	1994	1994	514582
DR 350	350	1996	1996	527251
GT 380 Sebring	380	1972	1977	514623
GSF 400 Bandit	400	1991	1995	514710
GSX 400 E	400	1980	1987	514847
GSX 400 S	400	1980	1987	514847
DR-Z 400	400	2000	2004	514981
DR-Z 400 E	400	2000	2007	514981
DR-Z 400 S	400	2000	2008	514981
DR-Z 400 SM	400	2005	2008	514981
DR-Z 400 SMU	400	2005	2007	514981
GS 400	400	1978	1992	514648
GSX 400 FE Katana	400	1981	1983	514772
GS 450 E (ROUE BATON)	450	1988	1988	514847
GS 450 EU (ROUE BATON)	450	1988	1988	514847
GS 450 S	450	1980	1988	514847
GS 450 SU	450	1988	1988	514847
RM-Z 450	450	2005	2007	514974
GS 450	450	1980	1988	514661
RM-Z 450	450	2008	2013	514973
GS 500 E	500	1994	2000	527284
GS 500 EU	500	1994	2000	527284
GS 500 E	500	1979	1979	514612
GS 500	500	2001	2006	514754
GS 500 F	500	2004	2006	514754
GS 500 FH	500	2007	2008	514754
GS 500 FM	500	2007	2008	514754

Modèle	Cylindre	Année début	Année fin	Réf.
GS 500 FU	500	2004	2006	514754
GS 500 H	500	2007	2008	514754
GS 500 HU	500	2007	2008	514754
GS 500 U	500	2001	2006	514754
DR 500 S	500	1981	1983	514727
GT 500	500	1976	1977	514623
T 500 Titan	500	1968	1975	514623
GS 500 E	500	1989	1993	514720
GS 500 EU	500	1989	1993	514720
RG 500 Gamma	500	1986	1986	514773
RG 500 C Gamma	500	1987	1989	514773
GS 550 D (ROUE RAYON)	550	1980	1980	514612
GS 550 E (ROUE BATON)	550	1978	1980	514612
GS 550 EG Red Suzi (ROUE BATON)	550	1980	1980	514612
GS 550 M Katana	550	1981	1983	514612
GS 550 M Katana	550	1982	1983	514612
GS 550 (ROUE RAYON)	550	1977	1979	514612
GS 550 L (ROUE BATON)	550	1980	1980	527243
GS 550 T (ROUE BATON)	550	1981	1981	527243
GS 550 M	550	1982	1982	514786
GT 550	550	1976	1977	514623
GT 550 Indy	550	1972	1975	514623
GSX 550 EF carenée	550	1984	1987	514601
GSX 550 E (modèle F)	550	1983	1984	514601
GSX 550 ES semie-carenée	550	1983	1987	514601
GSR 600	600	2006	2010	514938
GSR 600 A ABS	600	2007	2011	514938
GSR 600 U	600	2006	2010	514938
GSR 600 UA ABS	600	2007	2011	514938
GSX-R 600	600	2002	2003	514951
GSX-R 600 UI	600	2002	2002	514951
GSX-R 600 U2	600	2002	2003	514951
GSF 600 Bandit	600	2000	2004	514687
GSF 600 S Bandit	600	2000	2004	514687
GSF 600 SU Bandit	600	2000	2004	514687
GSF 600 U Bandit	600	2000	2004	514687
DR 600 R Dakar	600	1986	1989	514765
DR 600 RU Dakar	600	1987	1989	514765
DR 600 S	600	1985	1989	514765
DR 600 SU	600	1985	1989	514765
GSX-R 600	600	1997	2000	514895
GSX 600 F	600	1998	2001	514878
GSX 600 FU	600	1998	2001	514878
GSX-R 600	600	2006	2007	514793
GSX-R 600 U2	600	2006	2006	514793

Modèle	Cylindre	Année début	Année fin	Réf.
GSX-R 600 U3	600	2006	2006	514793
RF 600 R	600	1993	1996	514761
RF 600 RU	600	1993	1996	514761
GSX-R 600	600	2004	2005	514888
GSX-R 600 U2	600	2004	2005	514888
GSX-R 600 U3	600	2004	2005	514888
GSX 600 F	600	1988	1997	527278
GSX 600 FU	600	1988	1997	527278
GSX 600 FU2	600	1988	1997	527278
GSF 600 SU Bandit	600	1996	1999	514728
GSF 600 U Bandit	600	1995	1999	514728
GSX-R 600 X Anniversaire	600	2005	2005	514888
GSX-R 600 XU2 Anniversaire	600	2005	2005	514888
GSX-R 600 XU3 Anniversaire	600	2005	2005	514888
GSF 600 Bandit	600	1995	1999	514728
GSF 600 S Bandit	600	1996	1999	514728
GSX-R 600	600	2008	2010	514747
GSX-R 600 U2	600	2007	2008	514747
GSX-R 600 U3	600	2007	2008	514747
GSX-R 600 UE	600	2009	2010	514747
GSX-R 600 UF	600	2009	2010	514747
GSX-R 600	600	2001	2001	514826
SV 650	650	2003	2008	527227
SV 650 ABS	650	2003	2008	527227
LS 650 P Savage guidont haut	650	1986	2000	527310
SV 650	650	1999	2002	514790
SV 650 U	650	1999	2002	514790
DL 650 A V-Strom ABS	650	2007	2011	514745
DL 650 AU3 V-Strom ABS	650	2007	2008	514745
DL 650 AUE V-Strom ABS	650	2009	2011	514745
DL 650 U3 V-Strom	650	2004	2008	514745
DL 650 UE V-Strom	650	2009	2010	514745
DL 650 V-Strom	650	2004	2011	514745
SV 650 S	650	1999	2002	514887
SV 650 SU	650	1999	2002	514887
DR 650 R Dakar	650	1990	1991	514765
DR 650 RU Dakar	650	1990	1990	514765
SV 650 S	650	2003	2016	527228
SV 650 SA ABS	650	2007	2010	527228
SV 650 SU	650	2003	2010	527228
SV 650 SUA ABS	650	2007	2008	527228
DR 650 SE	650	1996	2000	514969
DR 650 SEU	650	1996	2000	514969
XF 650 Freewind	650	1997	2002	515128
XF 650 U Freewind	650	1997	2002	515128
DL650 K4/K5/K6 V-Strom	650	2004	2006	527238

Modèle	Cylindre	Année début	Année fin	Réf.
DL650 AK7/AK8/AK9/ALO V-Strom ABS	650	2007	2011	527238
DL650 XK7/XK8/XK9/XAO V-Strom (X)	650	2007	2011	527238
DL650 ALIXP V-Strom (Xpedition)	650	2011	2011	527238
DL650 AK9GT V-Strom (Traveller)	650	2007	2011	527238
GSF 650 A Bandit ABS	650	2005	2006	514818
GSF 650 Bandit	650	2005	2006	514818
GSF 650 S Bandit	650	2005	2006	514818
GSF 650 SA Bandit ABS	650	2005	2006	514818
GSF 650 SU Bandit	650	2005	2006	514818
GSF 650 SUA Bandit ABS	650	2005	2006	514818
GSF 650 U Bandit	650	2005	2006	514818
GSF 650 UA Bandit ABS	650	2005	2006	514818
SV 650 S	650	1999	2002	514788
SFV 650 Gladius	650	2009	2014	514869
DR 650 SE	650	2001	2014	527191
GSX 750 L	750	1980	1980	514841
GSX-R 750	750	2002	2003	514951
GSX 750 EF carenée	750	1984	1986	514808
GSX 750 ES semie-carenée	750	1983	1986	514808
GSX 750 F	750	1989	1997	514651
GSX-R 750	750	1996	1999	514895
GSX 750 (ROUE RAYON)	750	1980	1981	514976
GSX 750 EG Silver Suzi (ROUE BATON)	750	1980	1980	514976
GSX 750 E (ROUE BATON)	750	1980	1981	514976
GSX 750 F	750	1998	2001	514878
GSX-R 750	750	1988	1989	514941
GSX-R 750	750	2006	2007	514793
GSX-R 750 U2	750	2006	2007	514793
GSX-R 750	750	1990	1991	514943
DR 750 S Big	750	1988	1989	514603
DR 750 SU Big	750	1988	1989	514603
GSX 750 Inazuma	750	1998	2003	514758
GSX 750 S Katana	750	1982	1984	527328
GSX-R 750	750	2004	2005	514888
GSX-R 750 U2	750	2004	2005	514888
GSX-R 750 X	750	2005	2005	514888
GSX-R 750 XU2	750	2005	2005	514888
GS 750 E (ROUE BATON)	750	1978	1979	514663
GS 750 (ROUE RAYON)	750	1977	1979	514663
GS 750 D (ROUE RAYON)	750	1977	1979	514663
GSX-R 750 W	750	1992	1995	514780
GSX-R 750	750	2008	2010	514747

Modèle	Cylindre	Année début	Année fin	Réf.
GSX-R 750 U2	750	2008	2008	514747
GSX-R 750 UF	750	2009	2010	514747
GSX 750 ET	750	0	0	527270
GSX 750 EX	750	0	0	527270
GT 750	750	1972	1977	514623
GSX-R 750	750	2000	2001	514826
GSR 750	750	2011	2015	514742
VX 800 P	800	1990	1993	527229
VZ 800 Marauder	800	1997	2003	514702
DR 800 S Big	800	1990	1999	514603
DR 800 SU Big	800	1990	1999	514603
VZ 800 M 800 Intruder	800	2005	2006	514920
VZ 800 M 800 U Intruder	800	2005	2006	514920
VX 800	800	1990	1997	514889
VX 800 U	800	1990	1997	514889
Boulevard C50 VL 800	800	2005	2009	514819
Boulevard C50 T VL 800	800	2006	2007	514819
GS 850 GL	850	1980	1981	514916
GS 850	850	0	0	527270
GS 850 G	850	1979	1979	514975
GS 1000 G	1000	1980	1981	514762
GSX-R 1000	1000	2002	2002	514951
GSX-R 1000 U2	1000	2002	2002	514951
GS 1000 (ROUE RAYON)	1000	1978	1980	514976
GS 1000 H (ROUE BATON)	1000	1978	1980	514976
GS 1000 E (ROUE BATON)	1000	1978	1980	514976
GS 1000 S Sport	1000	1979	1979	514919
GS 1000 L	1000	1979	1979	514916
GSX-R 1000	1000	2001	2001	514853
GSX-R 1000	1000	2003	2004	514724
GSX-R 1000	1000	2005	2006	514776
GSX-R 1000 U2	1000	2005	2006	514776
GSX-R 1000	1000	2005	2006	514725
GSX-R 1000 U2	1000	2005	2006	514725
SX-R 1000	1000	2009	2011	527187
TL 1000 S	1000	1997	2000	514890
GS 1100 G	1100	1984	1986	514762
GSX 1100 L	1100	1980	1980	514841
GSX 1100 EF carenée	1100	1984	1987	514918
GSX 1100 ES semie-carenée	1100	1983	1987	514918
GSX 1100 E (ROUE BATON)	1100	1980	1981	514775
GSX 1100 (ROUE RAYON)	1100	1980	1981	514775
GSX 1100 ET	1100	0	0	527270
VZR 1800 M 1800 R Intruder (modèle F)	1800	2006	2007	515009

Modèle	Cylindre	Année début	Année fin	Réf.
VZR 1800 M 1800 RU2 Intruder (modèle F)	1800	2006	2007	515009
VZR 1800 M 1800 RZ Intruder (modèle F)	1800	2007	2007	515009
VZR 1800 M 1800 RZU2 Intruder (modèle F)	1800	2007	2007	515009

SYM

XS 125 K	125	2007	2012	527294
----------	-----	------	------	--------

TRIUMPH

Speed Four 600	600	2002	2005	514820
Thunderbird 1600	600	2009	2014	527364
Daytona 600	600	2003	2004	514821
Daytona 650	650	2005	2005	514821
Daytona 675	675	2013	2013	514921
Daytona 675 R	675	2011	2014	514921
Street Triple 675	675	2013	2013	514922
Daytona 675	675	2006	2011	514876
Street Triple 675	675	2006	2012	514815
Tiger 800	800	2011	2014	527359
Tiger 800 XC	800	2011	2016	527359
Tiger 800 XCA	800	2015	2015	527359
Bonneville 800 T100	800	2003	2004	527335
Bonneville 800 T100 Centennial	800	2002	2002	527335
America 800	800	2002	2007	514722
Speedstar 800	800	2002	2003	514877
Bonneville 865 SE	865	2009	2013	514811
Bonneville 865 EFI T100	865	2008	2015	527335
Bonneville 865 EFI T100 50th	865	2009	2009	527335
Bonneville 865 EFI T100 McQueen Edition	865	2012	2012	527335
Bonneville 865 T100	865	2005	2007	527335
Scrambler 865	865	2006	2017	514814
America 865	865	2011	2015	514833
Thruxton 865	865	2004	2015	514834
Speedmaster 865	865	2005	2007	514877
Bonneville 900 EFI T100 ABS	900	2017	2018	527335
Bonneville 900 EFI T100 Black ABS	900	2017	2018	527335
Street Twin 900 EFI ABS	900	2016	2018	527335
Tiger 900	900	1999	2001	514913
Thruxton 900	900	2003	2016	514822
Speed Triple 900	900	1997	1998	515003
Speed Triple 955 EFI	955	2004	2004	514860
Sprint 955 RS	955	2003	2004	514937
Sprint 955 ST	955	2004	2004	527360
Daytona 955	955	2002	2004	514796
Sprint 955 RS	955	2000	2002	514913

Modèle	Cylindre	Année début	Année fin	Réf.
Speed Triple 955 EFI	955	2002	2004	514823
Tiger 955 i	955	2001	2006	514913
Sprint 955 ST	955	1999	2001	514830
Daytona 955	955	2005	2007	514835
Speed Triple 955	955	1999	2001	514947
Speed Triple 1050	1050	2011	2014	527361
Speed Triple 1050 R	1050	2012	2014	527361
Tiger 1050	1050	2007	2013	514774
Tiger 1050 SE	1050	2010	2013	514774
Tiger 1050 Sport	1050	2013	2017	514774
Sprint 1050 GT	1050	2010	2013	527362
Sprint 1050 ST	1050	2005	2010	527363
Speed Triple 1050	1050	2004	2008	514668
Sprint 1050 ST	1050	2005	2010	514908
Bonneville 1200 T120 ABS	1200	2016	2018	527335
Bonneville 1200 T120 Black ABS	1200	2016	2018	527335
Thunderbird 1700 Storm	1700	2011	2014	527364
Thunderbird 1700 Commander	1700	2014	2019	514980
Thunderbird 1700 LT	1700	2014	2019	514980
Rocket 2300 III Touring	2300	2007	2018	514812
Rocket 2300 III	2300	2004	2008	514586
Rocket 2300 III Classic	2300	2004	2009	514587
VESPA				
PX 125 E	125	1981	1984	527351
PX 125 E Lusso	125	1983	1995	527351
PX 125 E Lusso starter électrique	125	1984	1998	527351
PX 125 T5	125	1985	1990	527351
PX 200 E GS Grand Sport	200	1988	1995	527351
PX 200 E GS Grand Sport starter électrique	200	1988	1998	527351
PX 200 E Lusso	200	1983	1995	527351
PX 200 E Lusso starter électrique	200	1984	1995	527351
PX 200 FL DT	200	1998	2003	527351
YAMAHA				
YS 125	125	2017	2017	527214
YZ 125	125	2005	2014	514993
DT 125 LC	125	1982	1984	514891
RD 125	125	1975	1975	527322
RD 125 DX	125	1975	1975	527322
XT 125 R	125	2005	2012	514681
XT 125 X	125	2005	2012	514681
DT 125 R	125	1991	1996	514685
DT 125 RE	125	2004	2006	514685
SR 125	125	1999	2002	514929
DT 125 RH	125	1997	2003	514685

Modèle	Cylindre	Année début	Année fin	Réf.
DT 125 X	125	2005	2006	514685
DT 125	125	1978	1981	514915
XTR 125 KSI25-23	125	0	0	527242
WR 125 R	125	2009	2017	514763
WR 125 X	125	2009	2017	514763
XV 125 H Virago	125	1997	2000	514962
XV 125 SH Virago	125	1999	2002	514962
YZF-R 125	125	2010	2013	527235
YBR 125 ED	125	2010	2016	514957
YBR 125 SPD Custom	125	2008	2016	514957
TDR 125	125	1996	2002	514676
YBR 125 ED	125	2005	2016	514813
XVS 125 H Drag Star	125	2000	2004	527257
XVS 250 Drag Star	125	2001	2004	527257
YZ 125	125	1994	2003	514926
MT-125	125	2015	2016	514583
MT-125 ABS	125	2015	2019	514583
RX 135 King	135	1991	2002	527169
DT 175	175	1978	1981	514915
MX 175	175	1979	1981	514915
DT 175 MX	175	1978	1983	514897
XT 225	225	1996	2000	514910
TTR 225	225	1999	1999	514910
WR 250 F	250	2001	2002	514795
YZ 250 F 4T	250	2001	2002	514795
YZ 250 F 4T	250	2003	2005	514753
YZ 250 2T	250	2005	2014	514960
RD 250 LC	250	1980	1983	514591
YZ 250 F 4T	250	2003	2005	514700
YZ 250 F 4T	250	2006	2009	527250
XT 250	250	1980	1990	514752
XS 250	250	1977	1980	527320
RD 250	250	1975	1975	514695
XV 250 S Virago	250	1995	2000	514962
YZ 250 F	250	2001	2002	514577
YBR 250	250	2007	2013	514838
WR 250 F	250	2001	2002	514577
YZ 250 2T	250	1997	1998	514873
DT 250	250	1977	1978	514964
YZ 250 2T	250	1983	1984	514862
YZ 250	250	1999	2003	514903
YZ 250	250	1988	1998	527305
YZF-R3	300	2015	2021	527196
RD 350 LC YPVS	350	1985	1985	527323
RD 350 LCF YPVS	350	1985	1985	527323
RD 350 LC YPVS	350	1983	1984	514760

Modèle	Cylindre	Année début	Année fin	Réf.
XT 350 N	350	1986	1995	514743
XT 350 H	350	1985	1990	514743
RD 350 F	350	1985	1985	527260
XS 360	360	1977	1978	527320
XS 400 SE	400	1980	1982	527342
WR 400	400	2000	2002	514795
RD 400	400	1976	1979	514669
WR 400 F	400	2000	2000	514577
WR 400 F	400	1998	1999	514928
YZ 400 F	400	1998	1999	514928
YZF 400	400	0	0	527180
XS 400 DOHC	400	1982	1984	514674
DT 400 MX	400	1977	1981	514964
WR 426 F	426	2001	2002	514795
YZ 426 F	426	2000	2002	514795
WR 426 F	426	2001	2002	514577
YZ 426 F	426	2000	2002	514577
WRF 426	426	0	0	527180
YZ 450 F	450	2004	2005	514753
YZ 450 F	450	2004	2005	514700
YZ 450 F	450	2006	2009	527297
WR 450 F	450	2006	2006	514867
RD 500 LC YPVS	500	1984	1985	514751
XT 500	500	1976	1989	527279
SR 500 SP (frein à disque)	500	1986	1991	514871
SR 500 SP (frein à tambour)	500	1988	1999	514871
SR 500 SP (ROUE RAYON)	500	1984	1986	514871
SR 500 G	500	1979	1983	527330
SR 500 SP	500	1978	1983	527330
XV 535 H Virago	535	1995	1997	527291
XV 535 H Virago DX	535	1998	2003	527291
XV 535 N Virago	535	1995	1997	527291
XV 535 N Virago DX	535	1998	2003	527291
XV 535 SH Virago	535	1995	1997	527291
XV 535 SN Virago	535	1995	1997	527291
XV 535	535	1995	2000	527291
XJ 550	550	1981	1984	514660
XT 550	550	1982	1983	527231
SRX 600	600	1987	1989	514698
YZF R6	600	2006	2020	514665
XJ 600 NH	600	1996	2003	527253
XJ 600 NN	600	1996	2003	527253
XJ 600 SH Diversion	600	1996	2003	527253
FZR 600 RH Genesis	600	1994	1995	514748
FZR 600 RM Genesis	600	1994	1995	514748
FZR 600 RN Genesis	600	1994	1995	514748

Modèle	Cylindre	Année début	Année fin	Réf.
YZF 600 RH Thunder Cat	600	1996	2002	514748
YZF 600 RN Thunder Cat	600	1996	2002	514748
XT 600 EH	600	1990	1995	515016
XT 600 EN	600	1990	1995	515016
XT 600 KH	600	1991	1995	515016
XT 600 KN	600	1991	1995	515016
YZF-R6 600	600	1999	2002	514746
XT 600 Z Tenere	600	1986	1991	515006
FZ6 600 N	600	2004	2007	515012
FZ6 600 NA ABS	600	2007	2008	515012
FZ6 600 NS	600	2005	2006	515012
FZ6 S2 600 NAHG ABS	600	2007	2010	515012
FZ6 S2 600 NHG	600	2007	2010	515012
FZ6 S2 600 SAHG Fazer ABS	600	2009	2010	515012
FZ6 S2 600 SHG Fazer	600	2009	2009	515012
YZF-R6 600 H	600	1999	2002	514746
YZF-R6 600 N	600	1999	2002	514746
FZ6 600 SA Fazer ABS	600	2006	2008	514958
FZ6 S2 600 SAHG Fazer ABS	600	2007	2008	514958
FZ6 S2 600 SHG Fazer	600	2007	2008	514958
FZ6 600 S Fazer	600	2004	2008	514958
XJ 600 SN Diversion	600	1996	2003	514959
FZR 600 H Genesis	600	1989	1990	527331
FZR 600 M Genesis	600	1989	1990	527331
FZR 600 N Genesis	600	1989	1990	527331
FZS 600 H Fazer	600	2002	2003	527226
FZS 600 N Fazer	600	2002	2003	527226
FZS 600 H Fazer	600	1998	2001	514777
FZS 600 N Fazer	600	1998	2001	514777
FZS 600 SH Fazer	600	2000	2001	514777
FZS 600 SN Fazer	600	2000	2001	514777
XT 600 EH	600	1996	2003	514939
FZR 600	600	1991	1993	527263
XJ 600 SH Diversion	600	1992	1995	514750
XJ 600 SN Diversion	600	1992	1995	514750
XJ 600 H	600	1984	1991	514769
XJ 600 N	600	1984	1991	514769
XT 600	600	1984	1989	527265
XT 600 Z Tenere	600	1983	1985	527269
YZF-R6 600	600	2008	2012	514734
YZF-R6 600 Anniversaire	600	2012	2013	514734
YX 600 Radian	600	0	0	514735
YZF-R6 600	600	2003	2004	514733
XJ6-F 600 Diversion	600	2010	2011	514955
XJ6-N 600	600	2009	2015	514955
XJ6-S 600 Diversion	600	2009	2015	514955

Modèle	Cylindre	Année début	Année fin	Réf.
XJ 6 N DIVERSION	600	2010	2014	527192
XJ 600 X	600	2010	2014	527192
XS 650	650	1975	1983	514697
XS 650 SE Special	650	1981	1983	514872
XVS 650 AH Drag Star Classic	650	2002	2007	514635
XVS 650 AN Drag Star Classic	650	2002	2007	514635
XVS 650 N Drag Star	650	2001	2003	514635
XJ 650 H	650	1980	1985	514857
XJ 650 N	650	1982	1985	514857
XJ 650 T Turbo	650	1982	1984	514857
XVS 650 AH Drag Star Classic	650	1998	2000	527230
XVS 650 AN Drag Star Classic	650	1998	2000	527230
XVS 650 H Drag Star	650	1997	2000	527230
XVS 650 N Drag Star	650	1997	2000	527230
XVS 650 H Drag Star	650	2001	2003	514636
XVS 650 AH Drag Star Classic	650	2001	2001	514636
XVS 650 AN Drag Star Classic	650	2001	2001	514636
XS 650	650	1975	1979	514706
TT 650 R	650	1998	2002	514787
XTZ 660 N Tenere	660	1992	1995	514992
XTZ 660 H Tenere	660	1991	1998	514992
MT-03 660	660	2006	2012	514909
XT 660 R	660	2004	2016	514631
XT 660 X	660	2004	2016	514631
XT 660 Z Tenere	660	2008	2014	514631
XT 660 ZA Tenere ABS	660	2011	2014	514631
XT 660 R	660	2004	2016	514631
XT 660 X	660	2004	2016	514631
XT 660 Z Tenere	660	2008	2014	514631
XT 660 ZA Tenere ABS	660	2011	2014	514631
MT-03	660	2016	2019	527212
MT-07	700	2018	2020	527204
FZ 07	700	2015	2017	527204
XTZ 750 H Super Tenere	750	1989	1997	514755
XS 750	750	1977	1977	527252
XS 750 E	750	1978	1979	527252
XJ 750 Seca	750	1982	1984	514699
XTZ 750 Super Tenere	750	1989	1995	527241
XJ 750	750	1984	1985	514660
XV 750 Virago (ROUE BATON)	750	1992	1994	514730
XV 750 Virago (ROUE RAYON)	750	1994	1997	514730
TDM 850 H	850	1991	1996	515020
TDM 850 N	850	1991	1993	515020
TDM 850	850	1996	2001	514767
TRX 850	850	1996	1999	514715
TDM 900	900	2002	2011	514879

Modèle	Cylindre	Année début	Année fin	Réf.
TDM 900 A ABS	900	2005	2013	514879
MT-09	900	2017	2018	514771
XSR 900	900	2016	2017	514771
XJ 900	900	1983	1986	514660
XJ 900 F	900	1985	1994	514660
FJ 09	900	2015	2016	527195
MT 09 Tracer	900	2016	2016	527195
XJ 900 S Diversion	900	1995	2003	514802
XVS 950 Bolt	950	2014	2020	527199
XVS 950 Bolt R-Spec	950	2014	2021	527199
FZ1 1000 S Fazer	1000	2006	2015	515010
FZ1 1000 S GT Fazer	1000	2007	2007	515010
FZ1 1000 SA Fazer ABS	1000	2007	2015	515010
FZ1 1000 SA GT Fazer ABS	1000	2007	2007	515010
YZF-R1 1000	1000	1998	2001	514925
YZF-R1 1000	1000	2004	2006	514619
YZF-R1 1000 SP	1000	2006	2006	514619
FZS 1000 Fazer	1000	2001	2005	515017
FZS 1000 S Fazer	1000	2003	2005	515017
YZF-R1 1000	1000	2007	2008	514615
XV 1000 TRI	1000	1981	1982	514757
FZ1 1000 N	1000	2006	2015	515014
FZ1 1000 NA ABS	1000	2008	2015	515014
YZF-R1 M	1000	2015	2019	527209
YZF-R1 S	1000	2016	2018	527209
YZF-R1	1000	2015	2019	527209
XV 1000 Virago	1000	1986	1986	514730
YZF-R1 1000	1000	2002	2003	514629
XS 1100	1100	1978	1979	514625
XS 1100	1100	1980	1983	527313
XVS 1100 A Drag Star Classic	1100	2000	2007	514639
XV 1100 SP Virago (ROUE RAYON)	1100	1994	1999	514730
XV 1100 Virago (ROUE BATON)	1100	1989	1993	514730
XV 1100 SP Virago (ROUE RAYON) +7	1100	1994	1999	514730
XV 1600 A WILD STAR	1600	1999	2004	527355
XV 1600 A Wild Star	1600	1999	2004	514885
TT 600 E	600	1994	1998	527358
TT 600 RE	600	2004	2004	527358

/ POIGNÉE GAZ



511980

POIGNEE GAZ BLACKWAY
TYPE DOMINO ALU NOIR



500724

POIGNEE GAZ CYCLO
TYPE DOMINO (+ REVETEMENT GAUCHE)



512922

POIGNEE GAZ DOMINO



506627

POIGNEE GAZ DOMINO COMMANDOS
NOIR



506629

POIGNEE GAZ DOMINO COMMANDOS
NOIR - ECO SANS REVETEMENT



506630

POIGNEE GAZ DOMINO
COMMANDOS V2 NOIR



506631

POIGNEE GAZ DOMINO COMMANDOS
VINTAGE



506632

POIGNEE GAZ DOMINO COMMANDOS
VINTAGE - TIRAGE DROIT



520816

POIGNEE GAZ DOMINO CROSS/ENDURO/
HR NOIR SANS REVETEMENT



519368

POIGNEE GAZ DOMINO HR CROSS NOIR
AVEC PROTECTION CAOUTCHOUC ET
ROULEMENT



245524

POIGNEE GAZ DOMINO RACING NOIR



3090

POIGNEE GAZ DOMINO ZAMAC NOIR



485554

POIGNEE GAZ MAXI SCOOTER DOMINO
ADAPT. 125 PIAGGIO X7/X8/X9/EVO/MP3
07 -> /VESPA



511040

POIGNEE GAZ MECABOITE/MOTO ADAPT.
MASH FIFTY/CAFE RACER/SCRAMBLER/
SEVENTY FIVE



506447

POIGNEE GAZ MECABOITE/MOTO OEM
RIEJU 50/125 MRT ->18/MRT PRO/MRX/SMX
(0/000.530.5000)



504231

POIGNEE GAZ MECABOITE/MOTO OEM
RIEJU 50/125 MRT/MARATHON/TANGO
18-> (0/000.530.7000)



490363

POIGNEE GAZ QUAD DOMINO
A GACHETTE



501098

POIGNEE GAZ QUAD TEKNIX A GACHETTE



518135

POIGNEE GAZ TIRAGE RAPIDE NOIR
(LIVREE AVEC TRANSMISSION
+ VIS TENDEUR MIOX125)



484664

POIGNEE GAZ TUN'R ALU CNC ARGENT -
LIVREE AVEC VIS CREUSE 10X125



451779

POIGNEE GAZ TUN'R ALU CNC BLEU -
AVEC VIS CREUSE 10X125



484665

POIGNEE GAZ TUN'R ALU CNC
NOIR - AVEC VIS CREUSE 10X125



489387

POIGNEE GAZ TUN'R ALU CNC
ROUGE - AVEC VIS CREUSE 10X125



460101

POIGNEE GAZ TUN'R ALU NOIR



460102

POIGNEE GAZ TUN'R
CROSS/PIT BIKE/DIRT NOIR



483720

POIGNEE GAZ TUN'R
MINI TARGA - NOIR (PLASTIQUE)



492600

POIGNEE GAZ TUN'R MINI TARGA - NOIR
TIRAGE DROIT



519806

POIGNEE GAZ TUN'R MINI TARGA BLANC



519803

POIGNEE GAZ TUN'R MINI TARGA BLEU



3087

POIGNEE GAZ TUN'R MINI TARGA CHROME



519804

POIGNEE GAZ TUN'R MINI TARGA JAUNE



519805

POIGNEE GAZ TUN'R MINI TARGA ROUGE



519810

POIGNEE GAZ TUN'R TARGA BLANC (METAL)



519807

POIGNEE GAZ TUN'R TARGA BLEU (METAL)



519808

POIGNEE GAZ TUN'R TARGA JAUNE (METAL)



3085

POIGNEE GAZ TUN'R TARGA NOIR

/ POIGNÉE GAZ



219590

POIGNEE GAZ TUN'R TARGA NOIR (METAL)



519809

POIGNEE GAZ TUN'R
TARGA ROUGE (METAL)



494341

POIGNEE GAZ TUN'R TYPE DOMINO
ALU NOIR



519674

POIGNEE GAZ TUN'R TYPE DOMINO
TIRAGE RAPIDE NOIR



491363

POIGNEE GAZ MAXI SCOOTER LUXE
(AVEC ROULEMENTS AIGUILLES)

/ CÂBLE GAZ

Modèle	Cylindre	Année début	Année fin	Réf.
APRILIA				
RS 125 Extrema	125	1995	2012	522016
RS 125 Replica	125	1995	2012	522016
Tuono 125	125	2003	2004	522016
Sportcity 125 One	125	2009	2013	522033
SR 125 Motard	125	2012	2016	522033
Atlantic 125 H2O 4T	125	2003	2008	522010
Atlantic 125 H2O 4T	125	2010	2012	522010
Scarabeo 125	125	2003	2003	522025
Sport City One 125 AIR 4T	125	2008	2011	522028
SR Motard 125 AIR 4T	125	2012	2014	522028
SR Max 125 i H2O 4T	125	2011	2014	522040
Leonardo 125	125	1999	2004	522013
Sport City One 125 AIR 4T	125	2008	2011	522029
SR Motard 125 AIR 4T	125	2012	2014	522029
SR Max 125 i H2O 4T	125	2011	2014	522039
Leonardo 150	150	1999	2004	522013
Atlantic 200 H2O 4T	200	2003	2006	522010
Scarabeo 200	200	2003	2003	522025
Atlantic 250 H2O 4T	250	2003	2006	522010
Atlantic 250 i H2O 4T	250	2006	2008	522010
Leonardo 250	250	1999	2004	522014
Leonardo 250 ST	250	2001	2001	522014
RS 250	250	1995	1997	522017
Atlantic 300 i H2O 4T	300	2010	2012	522010
SR Max 300 i H2O 4T	300	2011	2014	522040

Modèle	Cylindre	Année début	Année fin	Réf.
SR Max 300 i H2O 4T	300	2011	2014	522039
Pegaso 650	650	1997	2000	522015
Pegaso 650 ie	650	2001	2004	522015
Pegaso 650 ie Garda	650	2001	2004	522015
SRV 850 i H2O 4T	850	2012	2014	522042
SRV 850 i H2O 4T	850	2012	2014	522041
ETV 1000	1000	2001	2007	522012
ETV 1000	1000	0	0	522011
RSV 1000 SP	1000	1999	1999	522022
RSV 1000 TUONO	1000	2002	2005	522022
RSV 1000	1000	1998	2003	522022
RSV 1000 Tuono	1000	2002	2005	522023
RSV 1000	1000	1998	2003	522023
RSV 1000 SP	1000	1999	1999	522023
BENELLI				
TNT 600	600	2014	2019	522045
TNT 600	600	2014	2019	522044
BMW				
C1	125	2000	2002	522049
R 25/3	250	1954	1955	522124
R 27	250	1961	1965	522125
R 35	350	0	0	522126
R 45	450	1978	1984	522129
R 45	450	1978	1984	522128
R 45	450	1978	1984	522127
G 450 X	450	2008	2010	522064
R 50/2	500	1968	1970	522131

Modèle	Cylindre	Année début	Année fin	Réf.
R 51	500	1950	1953	522133
R 50/2	500	1968	1970	522130
R 50/5	500	1969	1973	522132
R 60/2	600	1967	1970	522131
R 69 S	600	1967	1970	522131
R 67	600	1951	1955	522133
R 68	600	1952	1954	522133
R 60/7	600	1979	1984	522129
R 60/2	600	1967	1970	522130
R 69 S	600	1967	1970	522130
R 60/7	600	1978	1984	522127
C 600 Sport	600	2011	2015	522047
R 60	600	1977	1978	522134
R 60/6	600	1974	1976	522134
R 60/5	600	1969	1973	522132
R 60/6	600	1973	1976	522132
R 60/7	600	1977	1979	522132
C 600 Sport	600	2011	2015	522048
G 650 Xchallenge	650	2007	2007	522067
G 650 Xmoto	650	2007	2007	522067
G 650 GS	650	2009	2010	522065
F 650 CS	650	2001	2005	522065
F 650 GS Dakar	650	2000	2007	522065
R 65 GS	650	1981	1991	522129
R 65 LS	650	1978	1984	522129
R 65	650	1986	1986	522138
R 80	650	1985	1987	522138
F 650 GS	650	2000	2007	522065
G 650 GS	650	2011	2016	522066
G 650 GS Sertao	650	2012	2014	522066
R 65	650	1985	1994	522128
R 65 LS	650	1978	1984	522128
R 65 RT	650	1985	1994	522128
R 65	650	1979	1985	522136
F 650	650	1997	2000	522050
F 650 ST	650	1997	1997	522050
R 65	650	1986	1986	522137
R 65	650	1979	1985	522135
F 650 800 GS	650	2008	2012	522051
F 650 800 GS ABS	650	2008	2012	522051
C 650 Sport	650	2015	2021	522047
C 650 GT	650	2011	2021	522047
G 650 Xcountry	650	2008	2009	522068
F 650 GS	650	2000	2003	522053
R 65 LS	650	1982	1985	522139
F 650 GS	650	2008	2012	522052

Modèle	Cylindre	Année début	Année fin	Réf.
C 650 Sport	650	2015	2021	522048
C 650 GT	650	2011	2021	522048
R 65 LS	650	1982	1985	522127
R 80/7	650	1978	1980	522127
R 65 LS	650	1982	1985	522136
F 700 800 GS ABS	700	2013	2014	522054
F 700 GS	700	2011	2016	522055
K 75	740	1986	1995	522091
K 75	740	1986	1995	522092
K 75	740	1986	1990	522094
K 75	740	1986	1995	522093
K 75	740	1986	1994	522095
K 75	740	1986	1994	522096
R 75/5	750	1969	1973	522141
R 75/6	750	1973	1976	522141
R 75/7	750	1976	1979	522141
R 75/7	750	1979	1984	522129
R 75/7	750	1978	1984	522127
R 75	750	1977	1977	522140
R 75/6	750	1974	1976	522140
R 80 RT	800	1986	1994	522128
R 80/7 N	800	1977	1980	522141
R 80/7 S	800	1977	1980	522141
R 80/7	800	1979	1984	522129
R 80 GS	800	1981	1991	522129
R 80 RT	800	1976	1985	522129
R 80 ST	800	1981	1991	522129
R 80	800	1985	1994	522128
F 800 GT	800	2005	2009	522058
F 800 S	800	2005	2009	522058
R 80 GS	800	1981	1991	522127
R 80 RT	800	1976	1985	522127
R 80 ST	800	1981	1991	522127
F 800 R	800	2010	2013	522062
R 80	800	1985	1987	522137
F 800 800 GS ABS	800	2013	2014	522054
F 800 800 GS Adventure ABS	800	2013	2014	522054
F 800 R	800	2010	2013	522061
F 800 GT	800	2011	2016	522059
F 800 GS Adventure	800	2012	2016	522055
F 800 GS	800	2009	2012	522057
F 800 R	800	2015	2016	522055
F 800 GT	800	2012	2016	522060
F 800 ST	800	2007	2012	522063
F 800 GS	800	2009	2012	522056
F 800 GS	800	2013	2016	522055

Modèle	Cylindre	Année début	Année fin	Réf.
R 80	800	1981	1986	522136
R 80/7	800	1978	1980	522140
R 850 R	850	1996	1997	522145
R 850 R	850	1996	1997	522142
R 850 R	850	1996	1997	522143
R 850 R	850	1996	1997	522144
R 90/6	900	1974	1976	522147
R 900 RT 05 SF	900	2009	2010	522149
R 900 RT 10 SF	900	2009	2010	522149
R 900 RT	900	2004	2013	522148
R 900 RT 05 SF	900	2009	2010	522150
R 90 S	900	1974	1976	522146
R 900 RT 05 SF	900	2009	2010	522151
R 900 RT 10 SF	900	2009	2010	522152
R 90/6	900	1974	1976	522140
R 100 CS	1000	1981	1981	522097
R 100 RS	1000	1977	1977	522097
R 100 RS	1000	1979	1984	522097
K 100 RS	1000	1985	1989	522095
R 100 GS	1000	1988	1990	522138
K 100	1000	1985	1986	522093
R 100 GS Paris-Dakar	1000	1989	1990	522138
R 100 R	1000	1992	1994	522100
R 100 RT	1000	1988	1996	522138
R 100 R Mystik	1000	1994	1995	522100
R 100 T	1000	1979	1984	522097
R 100 RT	1000	1979	1984	522103
R 100 R	1000	1992	1994	522099
R 100 R Mystik	1000	1994	1995	522099
R 100 RS	1000	1988	1988	522101
R 100 RS	1000	1992	1992	522101
R 100 T	1000	1979	1984	522147
K 100 LT	1000	1987	1991	522093
K 100 RT	1000	1984	1988	522093
R 100 GS	1000	1991	1995	522100
R 100 GS Paris-Dakar	1000	1991	1996	522100
R 100/7T	1000	1977	1978	522147
R 100 CS	1000	1981	1981	522098
R 100 RS	1000	1977	1977	522098
R 100 RS	1000	1979	1984	522098
R 100 RT	1000	1978	1984	522098
R 100 T	1000	1979	1984	522098
R 100/7	1000	1976	1978	522141
K 100 RT	1000	1984	1988	522091
R 100 T	1000	1979	1984	522103
R 100 GS	1000	1991	1995	522099

Modèle	Cylindre	Année début	Année fin	Réf.
R 100 GS Paris-Dakar	1000	1991	1996	522099
K 100	1000	1985	1986	522091
R 100 GS	1000	1988	1990	522137
R 100 RT	1000	1988	1996	522137
HP4	1000	2013	2014	522073
S 1000 RR	1000	2012	2014	522073
S 1000 RR	1000	2010	2011	522154
K 100 RS	1000	1991	1992	522074
S 1000 RR	1000	2010	2011	522155
HP4	1000	2013	2014	522072
S 1000 RR	1000	2012	2014	522072
R 100 RS	1000	1977	1977	522102
R 100 RS	1000	1979	1984	522102
R 100 RT	1000	1978	1984	522102
K 100 RS	1000	1985	1989	522096
R 100 T	1000	1979	1984	522102
R 100/7 T	1000	1977	1978	522102
R 100 S	1000	1977	1980	522046
K1	1000	1990	1992	522074
R 1100 S	1100	1998	2004	522108
R 1100 RS	1100	1992	2001	522104
R 1100 GS	1100	1994	1999	522142
R 1100 R	1100	1995	2001	522142
R 1100 GS	1100	1994	1999	522145
R 1100 R	1100	1995	2001	522145
R 1100 RS	1100	1992	2001	522145
R 1100 RT	1100	1995	2002	522145
R 1100 GS	1100	1994	1999	522143
R 1100 R	1100	1995	2001	522143
R 1100 GS	1100	1994	1999	522144
R 1100 R	1100	1995	2001	522144
R 1100 RS	1100	1992	2001	522144
R 1100 S	1100	1998	2004	522106
R 1100 RS	1100	1992	2001	522105
K 1100 LT	1100	1992	1997	522075
K 1100 RS	1100	1993	1996	522074
R 1100 RT	1100	1995	2001	522104
R 1100 RT	1100	1995	2001	522144
R 1100 RT	1100	1995	2001	522143
R 1100 S	1100	1998	2004	522107
R 1100 S	1100	1998	2004	522109
R 1150 R Rockster	1150	2003	2005	522112
R 1150 GS	1150	1999	2004	522145
R 1150 GS Adventure	1150	2002	2006	522145
R 1150 RS	1150	2001	2004	522145
R 1150 GS	1150	1999	2004	522110

Modèle	Cylindre	Année début	Année fin	Réf.
R 1150 GS Adventure	1150	2002	2006	522110
R 1150 GS Adventure	1150	2002	2006	522144
R 1150 RS	1150	2001	2004	522144
R 1150 RT	1150	2000	2006	522144
R 1150 RT	1150	2000	2006	522114
R 1150 RS	1150	2001	2004	522113
R 1150 R	1150	2001	2005	522145
R 1150 GS	1150	1999	2004	522144
R 1150 R Rockster	1150	2003	2005	522145
R 1150 R	1150	2001	2005	522144
R 1150 R Rockster	1150	2003	2005	522144
R 1150 R	1150	2001	2005	522111
R 1150 RT	1150	2000	2006	522145
R 1200 S	1200	2006	2007	522122
K 1200 S	1200	2005	2007	522086
HP2 Sport	1200	2008	2009	522070
R 1200 S	1200	2006	2007	522070
R 1200 GS	1200	2006	2006	522149
R 1200 GS Adventure	1200	2006	2013	522149
R 1200 R	1200	2007	2014	522149
R 1200 RT	1200	2005	2014	522149
R 1200 ST	1200	2005	2005	522149
HP2 Enduro	1200	2006	2006	522149
HP2 Megamoto	1200	2008	2008	522149
R nineT	1200	2014	2020	522149
R nineT Pure	1200	2017	2020	522149
R nineT Racer	1200	2018	2019	522149
R nineT Scrambler	1200	2017	2020	522149
HP2 Sport	1200	2008	2009	522071
R nineT Urban G/S	1200	2017	2018	522149
R 1200 S	1200	2006	2007	522071
R 1200 HP	1200	2005	2007	522148
K 1200 S	1200	2008	2014	522087
R 1200 C Independent	1200	2001	2003	522115
K 1200 R	1200	2005	2008	522083
K 1200 R Sport	1200	2007	2007	522083
K 1200 RS	1200	2001	2004	522085
R 1200 Montauk	1200	2003	2005	522119
R 1200 C Independent	1200	2001	2004	522119
R 1200 CL	1200	2003	2004	522116
R 1200 GS	1200	2004	2007	522118
R 1200 GS Adventure	1200	2006	2008	522118
HP2 Sport	1200	2008	2009	522069
R 1200 GS	1200	2004	2013	522148
R 1200 GS Adventure	1200	2006	2013	522148
R 1200 R	1200	2007	2014	522148

Modèle	Cylindre	Année début	Année fin	Réf.
K 1200 RS	1200	1997	2000	522084
R 1200 RT	1200	2005	2009	522150
R 1200 CL	1200	2003	2004	522117
R nineT	1200	2014	2020	522153
R nineT Pure	1200	2017	2020	522153
R nineT Scrambler	1200	2017	2020	522153
R nineT Urban G/S	1200	2017	2018	522153
R 1200 R	1200	2007	2010	522120
R 1200 R	1200	2011	2014	522153
K 1200 LT	1200	1999	2008	522081
K 1200 GT	1200	2003	2004	522077
K 1200 GT	1200	2003	2004	522078
R 1200 ST	1200	2005	2005	522123
K 1200 GT	1200	2006	2008	522079
R 1200 GS Adventure	1200	2009	2013	522153
R 1200 RT	1200	2005	2009	522151
R 1200 RT	1200	2010	2014	522121
R nineT Racer	1200	2017	2018	522152
R 1200 RT	1200	2010	2014	522152
R 1200 C	1200	1997	2004	522115
R 1200 CL	1200	2003	2004	522115
K 1200 LT	1200	1999	2008	522082
K 1200 GT	1200	2006	2008	522080
K 1200 GT	1200	2003	2004	522076
K 1200 RS	1200	2001	2004	522076
R 1200 C	1200	1997	2004	522119
K 1300 R	1300	2009	2010	522089
K 1300 R	1300	2009	2010	522088
K 1300 S	1300	2009	2016	522087
K 1300 S	1300	2009	2016	522090
CF MOTO				
CF 150-3A	150	2015	2019	522157
CF 150-3	150	2015	2019	522157
150 NK	150	2015	2019	522157
250 NK	250	2017	2019	522156
300 NK	300	2019	2019	522156
NK 400	400	2016	2019	522159
NK 400	400	2016	2019	522158
CF 600	600	2013	2015	522158
CF 650	650	2016	2019	522159
DAELIM				
ROADWIN 250 R	250	0	0	522161
DAYSTAR 250	250	0	0	522160
S3 ADVANCE 250	250	0	0	522162

Modèle	Cylindre	Année début	Année fin	Réf.
DERBI				
Boulevard 125 AIR 4T	125	2008	2012	522028
Variant Sport 125 AIR 4T	125	2012	2012	522028
Boulevard 125 AIR 4T	125	2008	2012	522029
Variant Sport 125 AIR 4T	125	2012	2012	522029
Boulevard 150 AIR 4T	150	2010	2010	522028
Boulevard 150 AIR 4T	150	2010	2010	522029
GPI 250	250	2006	2006	522163
DUCATI				
Supersport 400 SS	400	1993	1995	522206
Supersport 400 SS	400	1993	1995	522207
Supersport 600 SS Carenata	600	1994	1998	522206
Supersport 600 SS Nuda	600	1994	1998	522206
Monster 600	600	1994	2001	522186
Monster 600 City	600	1999	2000	522186
Monster 600 City Dark	600	1999	2000	522186
Monster 600 Dark	600	1998	2001	522186
Monster 600 Metallic	600	2000	2001	522186
Monster 600	600	1994	2001	522187
Monster 600 City	600	1999	2000	522187
Monster 600 City Dark	600	1999	2000	522187
Monster 600 Dark	600	1998	2001	522187
Monster 600 Metallic	600	2000	2001	522187
Supersport 600 SS Carenata	600	1994	1998	522207
Supersport 600 SS Nuda	600	1994	1998	522207
Multistrada 620 ie DD	620	2005	2006	522194
Multistrada 620 ie MD Dark	620	2005	2006	522194
Monster 620 ie DD	620	2002	2006	522188
Monster 620 ie DD Dark	620	2004	2005	522188
Monster 620 ie MD Dark	620	2003	2006	522188
Monster 620 S ie	620	2002	2003	522188
S 620 ie Sport Carenata	620	2003	2003	522196
S 620 ie Sport Nuda	620	2003	2003	522196
Monster 695	695	2007	2008	522188
Monster 696	696	2008	2010	522189
Monster 696 ABS	696	2010	2010	522189
Monster 696	696	2011	2012	522190
Monster 696 ABS	696	2011	2014	522190
Monster 696 Anniversaire ABS	696	2013	2013	522190
SP Sport Production	748	1995	1997	522198
SPS Sport Production	748	1998	1999	522198
Strada Biposto	748	1995	2003	522198
S Biposto/Monoposto	748	1997	1998	522197
S Biposto/Monoposto	748	2000	2002	522197
R Sport Production	748	2000	2002	522197

Modèle	Cylindre	Année début	Année fin	Réf.
Dark	749	2005	2007	522178
Supersport 750 SS Carenata	750	1994	1998	522206
Supersport 750 SS Nuda	750	1991	1998	522206
Monster 750	750	1996	2001	522186
Monster 750 Dark	750	1999	2001	522186
Monster 750 Metallic	750	2000	2001	522186
Monster 750 ie	750	2002	2002	522188
Monster 750 ie Dark	750	2002	2002	522188
Monster 750	750	1996	2001	522187
Monster 750 Dark	750	1999	2001	522187
Monster 750 Metallic	750	2000	2001	522187
Supersport 750 SS Carenata	750	1994	1998	522207
S 750 ie Sport Carenata	750	2001	2002	522196
S 750 ie Sport Nuda	750	2001	2002	522196
Supersport 750 SS ie Carenata	750	1999	2002	522196
Supersport 750 SS ie Nuda	750	1999	2002	522196
Supersport 750 SS Nuda	750	1991	1998	522207
Hypermotard 796	796	2010	2013	522182
Monster 796	796	2011	2012	522182
Monster 796 ABS	796	2011	2014	522182
Monster 796 Anniversaire ABS	796	2013	2013	522182
Monster 800 ie	800	2004	2004	522188
Monster 800 ie Dark	800	2003	2003	522188
Monster 800 ie S	800	2003	2003	522188
Monster 800 S2R	800	2005	2007	522188
Monster 800 S2R Dark	800	2005	2006	522188
S 800 ie Sport Carenata	800	2003	2003	522196
S 800 ie Sport Nuda	800	2003	2003	522196
Supersport 800 SS ie Carenata	800	2003	2004	522196
Supersport 800 SS ie Nuda	800	2003	2003	522196
848	848	2008	2009	522175
Evo	848	2012	2013	522175
Evo Corse Special Edition	848	2012	2013	522175
Streetfighter	848	2012	2014	522204
848	848	2008	2010	522176
SL 900 Super Light	900	1992	1997	522206
Supersport 900 SS Carenata	900	1990	1998	522206
Supersport 900 SS FE Final Edition	900	1998	1998	522206
Supersport 900 SS Nuda	900	1991	1998	522206
Monster 900	900	1993	1999	522186
Monster 900 City	900	1999	1999	522186
Monster 900 City Dark	900	1999	1999	522186
Monster 900 Cromo	900	1998	1999	522186
Monster 900 S	900	1998	1999	522186
Monster 900 ie	900	2002	2002	522188

Modèle	Cylindre	Année début	Année fin	Réf.
Monster 900	900	1993	1999	522187
Monster 900 City	900	1999	1999	522187
Monster 900 City Dark	900	1999	1999	522187
Monster 900 Cromo	900	1998	1999	522187
Monster 900 S	900	1998	1999	522187
SL 900 Super Light	900	1992	1997	522207
MH 900 E	900	2001	2002	522196
Supersport 900 SS ie Carenata	900	1999	2002	522196
Supersport 900 SS ie Nuda	900	1999	2002	522196
Supersport 900 SS Carenata	900	1990	1998	522207
Supersport 900 SS FE Final Edition	900	1998	1998	522207
Supersport 900 SS Nuda	900	1991	1998	522207
Monster 900 ie	900	2000	2001	522191
Monster 900 ie City	900	2000	2000	522191
Monster 900 ie City Dark	900	2000	2000	522191
Monster 900 ie Cromo	900	2001	2001	522191
Monster 900 ie Dark	900	2000	2002	522191
Monster 900 ie Metallic	900	2000	2001	522191
Monster 900 S ie Special	900	2000	2001	522191
Senna I Monoposto	916	1995	1996	522198
Senna II Monoposto	916	1997	1997	522198
Senna III Monoposto	916	1998	1998	522198
SP Sport Production	916	1994	1997	522198
Strada Biposto	916	1994	1998	522198
Monster S4 Monster	916	2001	2003	522192
ST4 Sporttouring	916	1999	2003	522203
ST2 944 Sporttouring	944	1997	2003	522196
ST 4S 996 Sporttouring	996	2004	2005	522201
ST 4S 996 Sporttouring ABS	996	2004	2005	522201
996 SPS 996 Sport Production	996	1997	1998	522198
996 Biposto/Monoposto	996	1999	2001	522198
996 R Sport Production	996	2001	2001	522198
996 S Biposto/Monoposto	996	2001	2001	522198
996 SPS Sport Production	996	1999	2000	522198
Monster 996 S4R	996	2004	2006	522192
ST 4S 996 Sporttouring	996	2001	2003	522203
ST 4S 996 Sporttouring ABS	996	2003	2003	522203
998 Biposto/Monoposto	998	2002	2003	522177
998 S Monoposto	998	2002	2002	522177
999	999	2003	2006	522178
999 R	999	2003	2006	522178
999 S	999	2003	2006	522178
Monster 1000 S4R	1000	2007	2008	522183
Monster 1000 S4RS	1000	2006	2008	522183
ST3 1000 Sporttouring	1000	2004	2005	522201

Modèle	Cylindre	Année début	Année fin	Réf.
Monster 1000 ie	1000	2003	2005	522188
Monster 1000 S ie	1000	2003	2005	522188
Monster 1000 S2R	1000	2006	2008	522188
1000 GT	1000	2007	2010	522174
1000 GT Touring	1000	2009	2010	522174
Desmosedici 1000 RR	1000	2008	2008	522179
Sport 1000 Sportclassic Biposto/Monoposto	1000	2007	2008	522200
Sport 1000 Sportclassic Monoposto	1000	2006	2007	522200
Sport 1000 Sportclassic Paul Smart	1000	2006	2006	522200
Multistrada DS 1000	1000	2003	2006	522195
Multistrada DS 1000 S	1000	2005	2006	522195
Sport 1000 S Sportclassic Biposto/Monoposto	1000	2007	2010	522199
Supersport 1000 SS Carenata	1000	2003	2004	522196
Supersport 1000 SS Nuda	1000	2003	2003	522196
Supersport DS 1000 SS Carenata	1000	2005	2007	522196
ST3 1000 Sporttouring	1000	2006	2007	522202
ST3 1000 S Sporttouring ABS	1000	2006	2007	522202
1098 R	1098	2008	2009	522175
1098 Biposto/Monoposto	1098	2007	2008	522176
1098 R	1098	2008	2009	522176
Hypermotard 1100	1100	2008	2009	522181
Hypermotard 1100 S	1100	2008	2009	522181
Monster 1100 Evo Anniversaire ABS	1100	2013	2013	522185
Streetfighter 1100 S	1100	2012	2013	522204
Multistrada 1100	1100	2007	2009	522195
Multistrada 1100 S	1100	2007	2009	522195
Streetfighter 1100	1100	2010	2011	522205
Streetfighter 1100 S	1100	2010	2011	522205
Hypermotard 1100 Evo	1100	2010	2013	522182
Hypermotard 1100 SP Evo	1100	2010	2010	522182
Monster 1100	1100	2009	2011	522184
Monster 1100 ABS	1100	2010	2011	522184
Monster 1100 S	1100	2009	2011	522184
Monster 1100 S ABS	1100	2010	2011	522184
Monster 1100 Diesel ABS diesel	1100	2013	2013	522185
Monster 1100 Evo ABS	1100	2012	2013	522185
1198	1198	2009	2009	522175
1198 S	1198	2009	2009	522175
1198	1198	2009	2011	522176
Diavel 1200 ABS	1200	2011	2018	522180
Diavel 1200 AMG ABS	1200	2012	2013	522180
Diavel 1200 Carbon ABS	1200	2011	2018	522180

Modèle	Cylindre	Année début	Année fin	Réf.
Diavel 1200 Cromo ABS	1200	2012	2013	522180
Diavel 1200 Dark ABS	1200	2013	2014	522180
Diavel 1200 Diesel ABS	1200	2017	2018	522180
Diavel 1200 Strada ABS	1200	2013	2014	522180
Diavel 1200 Titanium ABS	1200	2015	2015	522180
Multistrada 1200	1200	2010	2013	522193
Multistrada 1200 S	1200	2010	2014	522193
GILERA				
RUNNER 125 FX	125	2005	2005	522215
Runner ST 125 H2O 4T	125	2008	2013	522219
Nexus 125i H2O 4T	125	2008	2010	522040
Runner FX 125	125	1997	1998	522214
Runner 125 FX DD 2T	125	2000	2002	522213
Runner 125 FX DT 2T	125	1997	1999	522213
Runner SP 125 FX DD 2T	125	2000	2003	522213
Nexus 125i H2O 4T	125	2008	2010	522039
Runner VX 125 H2O 4T	125	1999	2007	522219
RUNNER 180 FXR	180	2005	2005	522215
Runner FXR 180	180	1997	1998	522214
Runner 180 FXR DD 2T	180	2000	2002	522213
Runner 180 FXR DT 2T	180	1997	1999	522213
Runner SP 180 FXR DD 2T	180	2000	2003	522213
Runner SP 180 FXR DT 2T	180	1999	1999	522213
Runner VXR 180 H2O 4T	180	2002	2004	522219
Runner VXR 180 H2O 4T	180	2006	2006	522219
Runner ST 200 H2O 4T	200	2008	2011	522219
Runner VXR 200 H2O 4T	200	2002	2006	522219
Nexus SP 250i H2O 4T	250	2006	2007	522039
Nexus 250i H2O 4T	250	2006	2007	522040
Nexus SP 250i H2O 4T	250	2006	2007	522040
Nexus 250i H2O 4T	250	2006	2007	522039
Nexus 300i H2O 4T	300	2008	2011	522040
Nexus 300i H2O 4T	300	2008	2011	522039
Nexus SP 500i H2O 4T	500	2006	2007	522040
Fuoco LT 500i H2O 4T	500	2013	2014	522209
Fuoco RL 500i H2O 4T	500	2007	2013	522209
GILERA NEXUS 500	500	2004	2008	522211
Nexus SP 500i H2O 4T	500	2006	2007	522212
Nexus 500i H2O 4T	500	2003	2008	522212
Fuoco LT 500i H2O 4T	500	2013	2014	522210
Fuoco RL 500i H2O 4T	500	2007	2013	522210
GP 800i H2O 4T	800	2007	2011	522042
GP 800i H2O 4T	800	2007	2011	522041
HONDA				
CB 125 F	125	2015	2020	522243

Modèle	Cylindre	Année début	Année fin	Réf.
CB 125	125	2012	2012	522241
CB 125 E	125	2012	2012	522241
CBF 125 M	125	2009	2012	522300
XL 125 K	125	1976	1978	522512
CB 125 F	125	2015	2020	522242
NSR 125	125	1993	2001	522411
XR 125 L	125	2003	2006	522535
CB 125 K	125	1972	1975	522244
CB 125 S	125	1971	1977	522245
CB 125 T	125	1988	1993	522247
CR 125 R	125	1990	2003	522363
TL 125 S	125	1978	1978	522437
CG 125 W	125	1998	1998	522355
CBR 125 R	125	2012	2019	522322
Activa S 125	125	2017	2019	522227
CBR 125 RS Repsol	125	2012	2019	522322
CBR 125 RT	125	2012	2019	522322
CBR 125 RW	125	2011	2011	522322
ANF 125 Innova	125	2003	2005	522229
CBR 125	125	2004	2010	522321
XL 125 R	125	1984	1985	522513
XL 125 S	125	1979	1983	522513
CB 125 TDC	125	1978	1989	522248
CB 125 TDE	125	1978	1989	522248
CM 125	125	0	0	522357
NES 125 Y	125	2000	2005	522410
SH 125	125	2001	2006	522410
CB 125 T	125	1978	1989	522248
NSR 125 (KY4)	125	1990	1999	522412
CB 125 S	125	1976	1978	522246
CB 125 J	125	1975	1982	522246
CG 125	125	1976	1984	522246
CG 125	125	1998	2006	522246
CG 125 Brasil	125	1985	1997	522246
CB 125	125	0	0	522240
Activa S 125	125	2017	2019	522228
CG 125 ES	125	0	0	522354
Fizy 125	125	0	0	522383
CB 150	150	2010	2010	522249
PCX 150	150	2015	2016	522425
PCX 150	150	2013	2013	522424
XL 185 S	185	1979	1982	522509
CD 185	185	0	0	522357
XR 200	200	1980	1981	522509
CD 200	200	0	0	522357
CBR 250 R	250	2011	2013	522324

Modèle	Cylindre	Année début	Année fin	Réf.
CBR 250 RA	250	2011	2013	522324
CBR 250 R-R	250	2013	2013	522324
CB 250 ND Euro	250	1982	1983	522256
CBR 250 R	250	2011	2013	522323
CBR 250 RA	250	2011	2013	522323
CRF 250 L	250	2013	2019	522367
CB 250 N Euro	250	1978	1981	522256
CB 250 T Twin	250	1977	1978	522256
VTR 250 MC33	250	2017	2017	522504
XL 250 R	250	1984	1988	522519
CB 250 Two-Fifty	250	1996	1998	522258
VTR 250 MC33	250	2017	2017	522503
CB 250 Two-Fifty	250	1996	1998	522259
XL 250	250	1973	1974	522515
XL 250 S	250	1978	1982	522521
CB 250 K	250	1968	1973	522252
CB 250 RS	250	1980	1981	522257
CB 250 RSZ	250	1982	1984	522257
XL 250 K	250	1973	1974	522518
CRF 250 R	250	2010	2013	522369
CR 250 R	250	1990	2001	522363
CMX 250 C Rebel	250	1996	1996	522362
CRF 250 R	250	2004	2009	522368
CBF 250	250	2004	2006	522301
CB 250 G	250	1974	1975	522250
XL 250 S	250	1978	1979	522520
CMX 250 C Rebel	250	1996	1996	522361
XR 250	250	1979	1979	522520
CRF 250 L	250	2013	2019	522366
XL 250	250	1972	1975	522514
CB 250 G	250	1974	1977	522251
CB 250 K	250	1973	1973	522251
CB 250 N Euro	250	1978	1981	522255
CB 250 ND Euro	250	1982	1983	522255
CB 250 T Twin	250	1977	1978	522255
CB 250 N Euro	250	1978	1981	522254
CB 250 ND Euro	250	1982	1983	522254
CB 250 T Twin	250	1977	1978	522254
CBF 250	250	2004	2006	522302
TRX 250	250	2005	2020	522438
CR 250 R	250	2001	2004	522364
XL 250	250	1978	1983	522517
XL 250	250	1978	1981	522516
CB 250 N Euro	250	1978	1981	522253
CB 250 ND Euro	250	1982	1983	522253
CB 250 T Twin	250	1977	1978	522253

Modèle	Cylindre	Année début	Année fin	Réf.
VT 250	250	0	0	522480
FORZA 300	300	2018	2021	522384
FORZA 300	300	2018	2021	522385
CBR 300 R	300	2015	2020	522324
CBR 300 RA	300	2015	2020	522324
XL 350 R	350	1985	1988	522519
XL 350	350	1974	1975	522522
CB 350 K	350	1968	1972	522252
CB 350 F Four	350	1973	1975	522260
XL 350	350	1974	1975	522514
CB 350 F Four	350	1973	1975	522261
CB 350 S	350	1986	1986	522262
CJ 360 T	360	1976	1977	522356
CB 360 G	360	1974	1974	522356
CL 360 Scrambler	360	1974	1976	522356
CB 360	360	1974	1974	522356
CB 360 G5	360	1974	1977	522251
CM 400 T Custom	400	1982	1983	522360
CB 400 F	400	1989	1990	522264
CB 400 A Twin automatique	400	1979	1979	522256
CB 400 N Euro	400	1978	1985	522256
CB 400 T	400	1977	1978	522256
CM 400 T	400	1980	1981	522358
CM 400 T Custom	400	1982	1983	522358
RVF 400 R	400	1995	1996	522427
RVF 400 R	400	1995	1996	522428
CM 400 T	400	1980	1981	522359
CM 400 T Custom	400	1982	1983	522359
VFR 400 RIII	400	1989	1991	522455
CB 400 F	400	1989	1990	522265
CM 400 T	400	1980	1981	522360
CB 400 A Twin	400	1979	1979	522255
CB 400 N Euro	400	1978	1985	522255
CB 400 T	400	1977	1978	522255
VFR 400 RIII	400	1989	1991	522456
CB 400 A Twin	400	1979	1979	522254
CB 400 N Euro	400	1978	1985	522254
CB 400 T	400	1977	1978	522254
CB 400 F Four	400	1974	1977	522266
CB 400 T	400	1980	1981	522267
CBR 400 RR	400	1990	1994	522326
CBR 400 R	400	1990	1993	522325
CB 400 F	400	1975	1976	522263
CB 400 A Twin automatique	400	1979	1979	522253
CB 400 N Euro	400	1978	1985	522253
CB 400 T	400	1977	1978	522253

Modèle	Cylindre	Année début	Année fin	Réf.
CB 450 N	450	1985	1985	522270
CRF 450 R	450	2009	2012	522369
CB 450 N	450	1985	1985	522269
CB 450 S	450	1982	1983	522267
CB 450 T	450	1982	1982	522267
TRX 450	450	0	0	522439
CB 450 K	450	1970	1970	522268
CRF 450 R	450	2002	2008	522370
CB 450 S	450	1987	1989	522272
CB 450 S	450	1986	1986	522271
CB 500 R	500	1994	1995	522276
CX 500 C	500	1980	1981	522376
CX 500 C	500	1980	1981	522375
CX 500	500	1980	1983	522358
CX 500	500	1980	1983	522359
CB 500 R	500	1995	1996	522277
CX 500	500	1980	1983	522373
CX 500	500	1978	1978	522372
CB 500 Four F	500	1970	1976	522274
XL 500 R Pro Link	500	1982	1985	522523
FT 500	500	1982	1983	522257
XBR 500 (ROUE BATON)	500	1985	1987	522507
XBR 500 S (ROUE RAYON)	500	1987	1989	522507
CX 500 E Euro Sports	500	1982	1986	522380
CX 500 TC Turbo	500	1982	1982	522380
CR 500 R	500	1990	2001	522363
VT 500 C Shadow	500	1983	1984	522482
VF 500 F Interceptor	500	1984	1987	522442
XBR 500 (ROUE BATON)	500	1985	1987	522508
XBR 500 S (ROUE RAYON)	500	1987	1989	522508
CX 500 C Custom	500	1982	1984	522377
XL 500 S	500	1979	1979	522520
XR 500	500	1979	1979	522520
CX 500 E Euro Sports	500	1982	1986	522381
CX 500 E Euro Sports	500	1982	1986	522379
CX 500 TC Turbo	500	1982	1982	522379
CX 500 C Custom	500	1982	1984	522378
VT 500 E	500	1983	1988	522483
CX 500 TC Turbo	500	1982	1982	522382
CB 500 K Four	500	1971	1977	522275
XL 500 R Pro Link	500	1982	1985	522524
GL 500 D Silverwing	500	1982	1983	522398
GL 500 D Silverwing	500	1982	1983	522397
FT 500	500	1982	1983	522386
XL 500 S	500	1979	1982	522525
VT 500 C Shadow	500	1983	1984	522481

Modèle	Cylindre	Année début	Année fin	Réf.
VF 500 F Interceptor	500	1984	1987	522443
CX 500 (High Handlebar)	500	1980	1983	522374
VT 500 E	500	1983	1988	522484
CX 500	500	1977	1979	522371
CBX 550 F Supersport	550	1982	1984	522349
CBX 550 F2 Supersport	550	1982	1984	522349
CBX 550 F Supersport	550	1982	1984	522348
CBX 550 F2 Supersport	550	1982	1984	522348
CB 550 K	550	1977	1978	522279
CB 550 K	550	1977	1978	522278
VT 600 C SHADOW	600	1992	1996	522486
VT 600 C Shadow	600	1989	1994	522488
VT 600 C Shadow Pinion coarsely toothed	600	1988	1988	522488
VT 600 C Shadow Pinion fine-toothed	600	1988	1988	522488
CBF 600 N	600	2004	2007	522303
CB 600 F Hornet	600	2007	2010	522282
CB 600 FA Hornet ABS	600	2007	2010	522282
CB 600 F Hornet	600	2002	2002	522281
CBF 600 N	600	2004	2010	522304
CB 600 F Hornet	600	2007	2010	522283
CB 600 FA Hornet ABS	600	2007	2010	522283
CBR 600 F	600	1987	1990	522328
XL 600 V Transalp	600	1987	2000	522529
XL 600 V Transalp	600	1987	2000	522528
CBR 600 RR	600	2007	2016	522338
CBR 600 RRA ABS	600	2009	2016	522338
XL 600 R	600	1983	1987	522526
CBR 600 F	600	1987	1990	522329
CBR 600 F	600	1991	1994	522330
CBR 600 RR	600	2003	2006	522336
CB 600 F Hornet	600	1998	2002	522280
CB 600 S F2 Hornet S	600	2000	2003	522280
VT 600 Shadow C	600	1995	2000	522490
VT 600 C Shadow	600	1989	1991	522487
CBR 600 F	600	2001	2007	522334
CBR 600 FR Rossi	600	2001	2002	522334
CBR 600 FS Sport	600	2001	2002	522334
CBR 600 F	600	1999	2000	522333
CBR 600 F	600	1999	2000	522332
CBR 600 RR	600	2007	2016	522339
CBR 600 RRA ABS	600	2009	2016	522339
CBF 600 S	600	2008	2010	522305
CBF 600 S	600	2008	2010	522306
CB 600 S F2 Hornet S	600	2000	2003	522284

Modèle	Cylindre	Année début	Année fin	Réf.
VT 600 C	600	1990	1994	522485
CBR 600 F	600	2001	2007	522335
CBR 600 FR Rossi	600	2001	2002	522335
CBR 600 FS Sport	600	2001	2002	522335
CBR 600	600	1991	2000	522327
XR 600 R	600	1988	2000	522537
XL 600 RM	600	1985	1987	522527
VT 600 Shadow C	600	1995	2000	522489
XR 600 R	600	1988	2000	522536
CBR 600 F	600	1991	1994	522331
CBR 600 RR	600	2003	2006	522337
NT 650 GT Hawk/Bros	650	1988	1990	522413
CB 650	650	1979	1982	522286
XRV 650 Africa Twin	650	1988	1990	522529
XRV 650 Africa Twin	650	1988	1990	522528
CBX 650	650	1983	1985	522350
NX 650 Dominator	650	1992	1994	522422
NT 650 V Deauville	650	1998	2001	522415
NT 650 V Deauville CBS	650	2002	2005	522415
NT 650 GT Hawk/Bros	650	1988	1990	522414
NTV 650 Revere	650	1988	1997	522414
NX 650 Dominator	650	1992	1994	522421
CB 650	650	1979	1982	522285
XL 650 V Transalp	650	2000	2007	522530
CX 650 C Custom	650	1983	1983	522269
CBX 650	650	1983	1985	522351
NT 650 V Deauville	650	1998	2001	522416
NT 650 V Deauville CBS	650	2002	2005	522416
NTV 650	650	1989	1991	522419
NC 700 X	700	2012	2015	522407
NC 700 X	700	2012	2015	522406
XL700 TRANSALP	700	2008	2011	522532
NT 700 V DEAUVILLE ABS	700	2006	2016	522418
NT 700 V DEAUVILLE	700	2006	2009	522418
XL700 TRANSALP	700	2008	2011	522531
XL700 TRANSALP High Bar +7 cm	700	2008	2011	522532
NT 700 V Deauville	700	2006	2011	522417
NC 700 S	700	2012	2013	522405
NC 700 S ABS	700	2012	2013	522405
XL 700 TRANSALP High Bar +7 cm	700	2008	2011	522531
NC 700 S	700	2012	2013	522404
NC 700 S ABS	700	2012	2013	522404
NC 750 INTEGRA S	750	2016	2018	522408
NC 750 INTEGRA	750	2016	2016	522408

Modèle	Cylindre	Année début	Année fin	Réf.
NC 750 INTEGRA S	750	2016	2018	522409
NC 750 INTEGRA	750	2016	2016	522409
CB 750 A	750	1992	2001	522287
VFR 750 F	750	1984	1987	522457
CB 750 F	750	1980	1982	522290
CB 750 F2	750	1982	1982	522290
CB 750 K	750	1978	1982	522290
VF 750 C Magna	750	1993	2000	522446
CB 750 K Four	750	1977	1978	522296
VF 750 C Magna	750	1993	2000	522444
CB 750 F	750	1975	1976	522288
CB 750 K	750	1971	1976	522288
CB 750 K Four	750	1977	1978	522297
CB 750 F2 Seven Fifty	750	1992	2003	522292
VF 750 F Interceptor V45	750	1983	1983	522447
VT 750 C Shadow	750	2004	2007	522492
VT 750 C2 Shadow Spirit	750	2007	2007	522492
VT 750 CA Shadow	750	2006	2007	522492
VFR 750 R	750	1988	1990	522464
CB 750 Four	750	1974	1974	522293
CB 750 F Super Sport	750	1975	1976	522293
CB 750 A	750	1976	1976	522293
VFR 750 F	750	1986	1989	522459
VFR 750 F	750	1994	1997	522463
VT 750 C2 Shadow Aero	750	1997	2000	522495
VT 750 C Shadow	750	1997	2000	522495
VFR 750 F	750	1990	1993	522461
CBX 750 F	750	1984	1986	522353
CBX 750 F	750	1984	1986	522352
NC 750 S	750	2014	2014	522404
NC 750 S ABS	750	2014	2015	522404
VFR 750 F	750	1990	1993	522460
CB 750 K Four	750	1969	1976	522294
VT 750 C Shadow	750	2008	2009	522494
VT750C Shadow Aero	750	2011	2020	522500
VT 750 C2 Shadow Spirit	750	2008	2009	522494
VT 750 CA Shadow	750	2008	2009	522494
VT 750 CS Shadow ABS	750	2010	2012	522494
CB 750 F2 Seven Fifty	750	1992	2003	522291
VT 750 DC Shadow Spirit	750	2001	2007	522498
VT 750 C Shadow	750	2004	2007	522493
VT 750 C2 Shadow Spirit	750	2012	2014	522496
VT 750 C2 Shadow Spirit	750	2007	2007	522493
VT 750 CA Shadow	750	2006	2007	522493
VT 750 C Shadow	750	1997	2000	522491
VT 750 C2 Shadow Aero	750	1997	2002	522491

Modèle	Cylindre	Année début	Année fin	Réf.
XLV 750 R	750	1983	1985	522533
XRV 750 Africa Twin	750	1991	2003	522538
CB 750 F	750	1980	1982	522289
CB 750 K	750	1978	1982	522289
XRV 750 Africa Twin	750	1993	2003	522539
VFR 750 F	750	1986	1987	522458
VFR 750 F	750	1994	1997	522462
VF 750 F Interceptor V45	750	1983	1984	522449
CB 750 K Four	750	1969	1976	522295
XLV 750 R	750	1983	1986	522534
RVF 750 R	750	1994	1995	522429
VF 750 F Interceptor V45	750	1983	1984	522448
VT 750 C2 Shadow Spirit	750	2012	2014	522497
NC 750 S	750	2014	2014	522405
NC 750 S ABS	750	2014	2015	522405
VT 750 DC Shadow Spirit	750	2001	2007	522499
VF 750 S Sabre V45	750	1982	1982	522450
VF 750 C Magna	750	1993	2000	522445
VFR 800	800	2002	2010	522466
VFR 800 A ABS	800	2002	2013	522466
VFR 800 FI	800	1998	2001	522468
VFR 800 FI Jubi Model	800	1999	1999	522468
VFR 800	800	2002	2010	522465
VFR 800 A ABS	800	2002	2013	522465
VFR 800 FI	800	1998	2001	522467
VFR 800 FI Jubi Modell	800	1999	1999	522467
VFR 800 X CROSSRUNNER	800	2011	2013	522469
CB 900 F Bol d'Or	900	1979	1983	522290
CBR 900 RR	900	1993	1999	522341
CBR 900 RR	900	1992	1999	522340
CBR 900 RR	900	2002	2003	522344
CBR 900 RR	900	2002	2003	522345
CB 900 F Hornet	900	2002	2006	522299
CBR 900 RR	900	2000	2001	522342
CB 900 F Bol d'Or	900	1979	1983	522289
CBR 900 RR	900	2000	2001	522343
CB 900 F Hornet	900	2002	2006	522298
VF 1000 F2 Bol d'Or	1000	1985	1985	522447
VF 1000 F Interceptor	1000	1984	1985	522447
CBR 1000 RR Fireblade	1000	2004	2007	522313
CBX 1000	1000	1981	1983	522347
VTR 1000 F Fire Storm	1000	1997	2006	522502
VTR 1000 F Fire Storm	1000	1997	2006	522501
CBR 1000 F	1000	1987	1989	522307
CBR 1000 RR Fireblade	1000	2004	2007	522312
CBR 1000 F	1000	1990	1992	522310

Modèle	Cylindre	Année début	Année fin	Réf.
CBR 1000 F	1000	1987	1989	522308
CBR 1000 F	1000	1990	1992	522309
CB 1000 R	1000	2008	2010	522235
CB 1000 RA ABS	1000	2008	2010	522235
XL 1000 V Varadero	1000	1999	2002	522510
VF 1000 R	1000	1984	1986	522440
CB 1000 F Super Four	1000	1993	1996	522233
GL 1000 Goldwing	1000	1975	1976	522388
GI 1000 GOLD WING	1000	1976	1976	522387
CB 1000 F Super Four	1000	1993	1996	522232
CBX 1000 Pro Link	1000	1981	1983	522347
CBR 1000 RR Fireblade	1000	2008	2012	522314
CBR 1000 RRS Fireblade Edition	1000	2008	2008	522314
VF 1000 F Interceptor	1000	1984	1985	522449
VF 1000 F2 Bol d'Or	1000	1985	1985	522449
XL 1000 V Varadero	1000	1999	2002	522511
VF 1000 F Interceptor	1000	1984	1985	522448
VF 1000 F2 Bol d'Or	1000	1985	1985	522448
CB 1000 R	1000	2008	2010	522234
CB 1000 RA ABS	1000	2008	2010	522234
VF 1000 R	1000	1985	1986	522441
CBR 1000 RR Fireblade	1000	2008	2012	522315
CBX 1000	1000	1979	1979	522223
CBR 1000 RR	1000	2008	2010	522311
CBX 1000	1000	1978	1983	522346
CB 1100 F Bol d'Or	1100	1983	1984	522290
GL 1100 Goldwing	1100	1980	1983	522390
CBR 1100 XX Super Blackbird	1100	1997	1998	522317
CB 1100 R	1100	1981	1981	522238
VT 1100 C3 Shadow Aero	1100	1998	2000	522478
CBR 1100 XX Super Blackbird	1100	1999	2008	522319
CB 1100 F	1100	1983	1983	522237
VT 1100 C2 Shadow ACE	1100	1995	2000	522476
VT 1100 C Shadow	1100	1988	1989	522473
CB 1100 R	1100	1981	1982	522239
VT 1100 C2 Shadow ACE	1100	1995	2000	522475
VT 1100 C2 Shadow ACE	1100	1995	2000	522475
VT 1100 C Shadow	1100	1988	1989	522472
VT 1100 C3 Shadow Aero	1100	1998	2000	522479
ST 1100 Pan European	1100	1990	2001	522435
ST 1100 A Pan European ABS	1100	1992	2001	522435
ST 1100 A Pan European Jubi ABS	1100	1999	1999	522435
CB 1100 F Bol d'Or	1100	1983	1984	522289
CBR 1100 XX	1100	1997	1998	522316

Modèle	Cylindre	Année début	Année fin	Réf.
CBR 1100 XX Super Blackbird	1100	2001	2005	522320
VT 1100 C2 Shadow	1100	2000	2007	522474
CBR 1100 XX Super Blackbird	1100	1999	2008	522318
CB 1100 F	1100	1983	1983	522236
ST 1100 Pan European	1100	1990	2001	522434
ST 1100 A Pan European ABS	1100	1992	2001	522434
ST 1100 A Pan European Jubi ABS	1100	1999	1999	522434
VT 1100 C2 Shadow Sabre	1100	2000	2007	522477
GL 1100 Goldwing	1100	1980	1983	522389
GL 1100 D Goldwing faring	1100	1980	1981	522389
GL 1200 D Goldwing	1200	1984	1988	522391
VFR 1200 X CROSSTOURER	1200	2016	2017	522453
GL 1200 D Goldwing	1200	1984	1988	522392
VFR 1200 X CROSSTOURER	1200	2016	2017	522454
VFR 1200 X CROSSTOURER	1200	2012	2013	522451
VFR 1200 X CROSSTOURER	1200	2012	2013	522452
VTX 1300 S	1300	2003	2007	522506
VTX 1300 R	1300	2005	2007	522506
VTX 1300 S	1300	2003	2007	522505
VTX 1300 R	1300	2005	2007	522505
GL 1500	1500	1988	1988	522393
GL 1500	1500	1988	1988	522394
GL 1800 Goldwing ABS	1800	2006	2012	522396
GL 1800 Goldwing ABS airbag navigation device	1800	2007	2012	522396
GL 1800 Goldwing ABS	1800	2006	2012	522395
GL 1800 Goldwing ABS airbag navigation device	1800	2007	2012	522395
PCX 150	150	2015	2016	522224
CB 175	175	1969	1975	522222
XL 500 S	500	1980	1982	522225
CB 600 F Hornet	600	1998	2001	522284
HUSQVARNA				
CR 125	125	2000	2007	522540
WR 125	125	2000	2007	522540
CR 125	125	2009	2014	522541
WR 125	125	2009	2014	522541
CR 250	250	2000	2005	522540
WR 250	250	2000	2007	522540
WR 360	360	2000	2000	522540
HYOSUNG				
GV 125	125	0	0	522553
GT 125	125	0	0	522550
COMET 125	125	2002	0	522549
GT 250 EFI	250	0	0	522551
GV 250	250	0	0	522553

Modèle	Cylindre	Année début	Année fin	Réf.
GT 250	250	0	0	522550
COMET 250	250	2002	0	522549
GT 250 R	250	2008	0	522552
GV 250 EFI	250	0	0	522554
GV 250 KARB.	250	0	0	522555
GV 650	650	2004	0	522557
GV 650	650	2004	0	522556
RX 125	125	0	0	522548
GF 125	125	0	0	522543
RX 125	125	0	0	522547
GA 125	125	0	0	522542
GP 125	125	0	0	522544
RT 125	125	0	0	522546
GT 650	650	0	0	522545
KAWASAKI				
KE 125 A	125	1976	1980	522591
KX 125 K	125	1994	1998	522600
KX 125 L	125	1999	2002	522600
KX 125 M	125	2003	2003	522600
KMX 125 B	125	1991	2003	522599
KX 250 F 4T	250	2009	2012	522603
250 S1	250	1972	1975	522558
EL 250 B Eliminator	250	1989	1989	522561
EL 250 D Eliminator	250	1990	1995	522561
EL 250 E Eliminator	250	1991	1995	522561
EL 250 B Eliminator	250	1989	1989	522562
EL 250 D Eliminator	250	1990	1995	522562
EL 250 E Eliminator	250	1991	1995	522562
KL 250 A1-A2	250	1978	1979	522592
KX 250 J	250	1992	1993	522600
KX 250 K	250	1996	1998	522600
KX 250 L	250	1999	2002	522600
KX 250 M	250	2003	2003	522600
KLR 250 D	250	1984	1992	522596
KLR 250 D	250	1984	1992	522595
F11 250	250	1971	1975	522572
KX 250 F 4T	250	2004	2005	522602
KX 250	250	1987	1987	522601
EL 252 F Eliminator	252	1996	2003	522561
EL 252 F Eliminator	252	1996	2003	522562
ATV Lakota 300 B Sport	300	2001	2003	522560
ATV Lakota 300 A	300	1995	2000	522560
KH 350 Mach 2	350	1972	1973	522558
Z 400 J	400	1980	1983	522633
Z 400 Twin	400	1977	1981	522634

Modèle	Cylindre	Année début	Année fin	Réf.
KH 400	400	1976	1978	522558
Z 400 J	400	1980	1983	522632
Z 400 B	400	1978	1980	522631
Z 400 D	400	1977	1977	522631
Z 400 G Custom	400	1979	1979	522631
Z 400 M GP	400	1983	1983	522631
Z 440 A Ltd	440	1980	1983	522635
Z 440 D Ltd Belt Drive	440	1982	1984	522635
Z 440 C	440	1980	1980	522631
KX 450 F	450	2012	2012	522603
KX 450 F	450	2009	2011	522604
EN 450 A Ltd	450	1985	1989	522563
KX 450 F	450	2006	2008	522602
EX 500 R Ninja	500	1997	2003	522570
EX 500 Ninja	500	1994	1996	522570
EX 500 A	500	1987	1993	522570
Z 500 B	500	1979	1980	522633
ER 500 A Twister	500	1997	2000	522568
ER 500 B Twister	500	1997	2000	522568
ER 500 C Twister	500	2001	2006	522568
ER 500 D Twister	500	2001	2006	522568
ER 500 A Twister	500	1997	2000	522567
ER 500 B Twister	500	1997	2000	522567
ER 500 C Twister	500	2001	2006	522567
ER 500 D Twister	500	2001	2006	522567
EN 500 A	500	1990	1993	522563
EN 500 B	500	1994	1995	522565
EN 500 C	500	1996	2003	522565
KLE 500 A	500	1991	2004	522594
KLE 500 B	500	2005	2007	522594
EN 500 A	500	1990	1993	522564
Z 500 B	500	1979	1980	522632
EN 500 B	500	1994	1995	522566
EN 500 C	500	1996	2003	522566
H1	500	1969	1971	522587
H1 500 SS	500	1969	1971	522587
KLE 500 A	500	1991	2004	522593
KLE 500 B	500	2005	2007	522593
EX 500 R Ninja	500	2004	2009	522571
GPZ 500 S	500	1987	2003	522579
HI-500	500	1969	1972	522588
KH 500 A8	500	1973	1977	522588
KX 500	500	1987	1987	522601
Z 550 B	550	1981	1982	522633
Z 550 D GP	550	1981	1981	522633
Z 550 H GP	550	1982	1983	522639

Modèle	Cylindre	Année début	Année fin	Réf.
GPZ 550 A Uni Trak	550	1987	1988	522580
Z 550 C Ltd	550	1980	1982	522637
Z 550 B	550	1981	1982	522632
Z 550 D GP	550	1981	1981	522632
ZR 550 A	550	1983	1983	522639
ZR 550 B Zephyr	550	1990	1993	522660
ZR 550 B Zephyr	550	1990	1993	522659
Z 550 C Ltd	550	1980	1982	522636
Z 550 H GP	550	1982	1983	522638
ZR 550 A	550	1983	1983	522638
ZX-6R 600 G Ninja	600	1998	1999	522671
ZX-6R 600 H Ninja catalyst	600	1998	1999	522671
GPZ 600 R Ninja	600	1985	1990	522581
GPX 600 R	600	1988	1996	522573
GPZ 600 R Ninja	600	1985	1990	522573
ZZR 600 E	600	1993	2006	522684
ZX-6RR 600 K Ninja	600	2003	2003	522673
ZX-6RR 600 M Ninja	600	2004	2004	522673
ER-6N	600	2009	2010	522569
ZX-6RR 600 N Ninja	600	2005	2006	522674
KLR 600 B	600	1985	1989	522596
ZX-6R 600 J Ninja	600	2000	2002	522672
KLR 600 B	600	1985	1989	522595
ZX-6R 600 F Ninja	600	1995	1997	522669
ZZR 600 E	600	1993	2006	522685
ZX-6R 600 F Ninja	600	1995	1997	522670
600 Ninja ZX-6R ABS KRT Edition	600	2017	2019	522559
Ninja ZX-6R	600	2013	2019	522559
Ninja ZX-6R KRT Edition	600	2016	2019	522559
ZX-6R ABS	600	2013	2019	522559
Ninja ZX-6R 30th Anniversaire Edition	600	2015	2015	522559
Ninja ZX-6R ABS KRT Edition	600	2016	2016	522559
Ninja ZX-6R ABS 30th Anniversaire Edition	600	2015	2015	522559
Ninja ZX-6R (European)	600	2013	2013	522559
ZX-6R 636 B Ninja	636	2003	2004	522673
ZX-6R 636 C Ninja	636	2005	2006	522674
ZX-6R 636 A Ninja	636	2002	2002	522672
Z 650 B	650	1977	1980	522640
Z 650 C	650	1978	1980	522640
Z 650 F	650	1981	1983	522640
Z 650 B	650	1977	1980	522641
Z 650 C	650	1978	1980	522641
Z 650 F	650	1981	1983	522641
Ninja 650 R	650	2006	2008	522608

Modèle	Cylindre	Année début	Année fin	Réf.
Z 650 SR	650	1979	1980	522637
Versys 650	650	2011	2013	522611
Versys 650 ABS	650	2014	2018	522611
Versys 650 LT	650	2015	2018	522611
NINJA 650 ABS	650	2013	2016	522569
NINJA 650	650	2012	2016	522569
Ninja 650R	650	2006	2008	522609
NINJA 650R	650	2009	2011	522569
KLR 650 A	650	1987	1987	522598
KLR 650 C	650	1995	2004	522598
KLR 650 A	650	1987	1987	522597
KLR 650 C	650	1995	2004	522597
Versys 650	650	2011	2013	522610
Versys 650 ABS	650	2014	2018	522610
Versys 650 LT	650	2015	2018	522610
Ninja 650	650	2012	2016	522607
Z 650 SR	650	1979	1980	522636
Ninja 650 R	650	2009	2011	522607
ER-6n	650	2009	2016	522607
Ninja 650 ABS	650	2013	2016	522607
VN 700	700	1985	1985	522613
VN 700	700	1985	1985	522614
Z 750 Twin B	750	1976	1978	522646
Z 750 Twin B	750	1976	1978	522647
ZXR 750 J	750	1991	1992	522680
ZXR 750 L	750	1994	1995	522680
GPX 750 R	750	1987	1988	522574
ZXR 750 H Stinger	750	1989	1990	522574
ZXR 750 J	750	1991	1992	522681
ZXR 750 L	750	1993	1995	522681
Z 750	750	2008	2010	522643
GPX 750 R	750	1987	1988	522575
ZXR 750 H Stinger	750	1989	1990	522575
ZX-7R 750 P Ninja	750	1996	2002	522675
ZX-7R 750 P Ninja	750	1996	2002	522676
Z 750 E	750	1980	1980	522644
Z 750 L	750	1981	1981	522644
Z 750	750	2007	2010	522642
Z 750 GP	750	1982	1982	522645
Z 750 L	750	1983	1984	522645
Z 750 GP Uni Trak	750	1983	1984	522645
ZX 750 E Turbo	750	1984	1984	522645
VN 750	750	1987	2003	522613
Vulcan VN 750	750	1986	2003	522614
ZR 750 C Zephyr	750	1991	1993	522660
ZR 750 C Zephyr	750	1991	1993	522659

Modèle	Cylindre	Année début	Année fin	Réf.
H2 750 Mach 4	750	1972	1972	522589
GPZ 750 A	750	1985	1985	522582
H2 750 A Mach 4	750	1973	1973	522589
GPZ 750 A	750	1985	1985	522583
VN 800 B Classic	800	1996	2006	522616
VN 800 B Classic	800	1996	2006	522615
VN 800 DRIFTER	800	1999	2003	522618
VN 800 DRIFTER	800	1999	2003	522617
GPZ 900 R Ninja	900	1990	1994	522585
GPZ 900 R Ninja	900	1986	1989	522585
Z 900 A	900	1976	1976	522649
ZI 900	900	1973	1973	522649
ZIA 900	900	1974	1974	522649
ZIB 900	900	1975	1975	522649
Z 900 A	900	1976	1976	522648
ZI 900	900	1973	1973	522648
ZIA 900	900	1974	1974	522648
ZIB 900	900	1975	1975	522648
ZX-9R 900 C Ninja	900	1998	1999	522679
ZX-9R 900 D Ninja catalyst	900	1998	1999	522679
ZX-9R 900 E Ninja	900	2000	2001	522679
ZX-9R 900 F Ninja	900	2002	2003	522679
ZX-9R 900 B Ninja	900	1994	1997	522678
GPZ 900 R Ninja	900	1984	1985	522586
GPZ 900 R Ninja	900	1985	1985	522586
ZX-9R 900 B Ninja	900	1994	1997	522677
VN 900 B Classic	900	2006	2015	522620
VN 900 B Classic Special Edition	900	2011	2015	522620
VN 900 C Custom	900	2015	2015	522620
VN 900 B Classic	900	2006	2015	522619
VN 900 B Classic Special Edition	900	2011	2015	522619
VN 900 C Custom	900	2015	2015	522619
GPZ 900 R Ninja	900	1990	1994	522584
GPZ 900 R Ninja	900	1986	1989	522584
ZX-10 R NINJA	1000	2011	2015	522664
ZIR 1000 D	1000	1978	1980	522654
GPZ 1000 RX Ninja	1000	1986	1987	522576
ZI1000	1000	1978	1979	522652
GPZ 1000 RX Ninja	1000	1986	1987	522577
Z 1000 J	1000	1981	1982	522625
Z 1000 R2	1000	1983	1983	522625
ZX-10 1000 B Tomcat	1000	1988	1990	522662
Z 1000 ST	1000	1979	1980	522627
Z 1000 A	1000	1978	1979	522623

Modèle	Cylindre	Année début	Année fin	Réf.
Z 1000 MK2	1000	1979	1980	522623
Z 1000 H Injection	1000	1980	1980	522623
Z 1000 K Ltd	1000	1981	1981	522626
Z 1000	1000	2004	2006	522643
ZX-10R 1000 E Ninja	1000	2008	2009	522667
Z 1000 A	1000	1978	1979	522624
Z 1000 MK2	1000	1979	1980	522624
Z1000	1000	1978	1979	522651
ZX-10R 1000 C Ninja	1000	2004	2004	522665
Z 1000 ST	1000	1979	1980	522628
ZX-10R 1000 D Ninja	1000	2006	2007	522666
Z 1000	1000	2005	2006	522642
ZX-10 1000 B Tomcat	1000	1988	1990	522663
ZIR 1000 D	1000	1978	1980	522653
KZ 1000	1000	1977	1980	522606
ZRX 1100 C	1100	1997	2000	522661
GPZ 1100 E	1100	1995	1998	522578
GPZ 1100 F ABS	1100	1996	1998	522578
ZRX 1100 C	1100	1997	2000	522578
GPZ 1100 A Uni Trak	1100	1983	1985	522625
GPZ 1100 B	1100	1981	1982	522625
Z 1100 ST	1100	1981	1983	522625
ZZR 1100 C	1100	1990	1992	522682
ZZR 1100 D	1100	1993	1997	522682
ZZR 1100 G catalyst	1100	1998	2001	522682
ZR 1100 A Zephyr (ROUE BATON)	1100	1992	1995	522658
ZR 1100 B Zephyr (ROUE RAYON)	1100	1996	1997	522658
ZZR 1100 C	1100	1990	1992	522683
ZZR 1100 D	1100	1993	1997	522683
ZZR 1100 G catalyst	1100	1998	2001	522683
ZR 1100 A Zephyr (ROUE BATON)	1100	1992	1995	522657
ZR 1100 B Zephyr (ROUE RAYON)	1100	1996	1997	522657
ZRX 1200 C	1200	2001	2004	522661
ZRX 1200 R (modèle F)	1200	2001	2006	522661
ZRX 1200 S semie-carenée	1200	2001	2004	522661
ZRX 1200 C	1200	2001	2004	522578
ZRX 1200 R (modèle F)	1200	2001	2006	522578
ZRX 1200 S semie-carenée	1200	2001	2004	522578
ZX-12R 1200 A Ninja	1200	2000	2001	522668
ZN 1300 Voyager	1300	1983	1986	522655
Z 1300 A	1300	1979	1983	522629
Z/ZG 1300 DFI	1300	1984	1989	522650
ZN 1300 Voyager	1300	1983	1986	522656

Modèle	Cylindre	Année début	Année fin	Réf.
Z 1300 ZG DFI	1300	1984	1989	522630
VN-15 1500 A	1500	1988	1990	522622
VN-15 1500 SE B	1500	1988	1994	522622
VN-15 1500 C	1500	1994	1995	522622
VN 1500	1500	1999	2001	522612
VN-15 1500 A	1500	1988	1990	522621
VN-15 1500 C	1500	1994	1995	522621
VN-15 1500 SE B	1500	1988	1994	522621
KEEWAY				
SUPERSHADOW 250	250	0	0	522688
CRUISER 250	250	0	0	522686
SUPERSHADOW 250	250	0	0	522687
KTM				
125 Duke	125	2011	2012	522690
125 Duke ABS	125	2013	2016	522690
125 EGS	125	1998	1999	522698
125 EXC	125	1998	2016	522698
125 EXC Sixdays	125	2009	2016	522698
125 EXE	125	2000	2000	522698
125 SX	125	1998	2016	522698
125 EGS 6KW	125	1998	1999	522694
125 EXC Six Days	125	2006	2007	522694
125 SXS	125	2001	2007	522694
150 SX	150	2009	2016	522698
150 XC	150	2010	2014	522694
200 Duke	200	2012	2012	522690
200 Duke ABS	200	2013	2017	522690
200 EGS	200	1998	1999	522698
200 EXC	200	1998	2016	522698
200 SX	200	2003	2004	522698
200 XC-W	200	2010	2016	522694
EXC SIX DAYS TPI EUROPE	250	2018	2020	522704
EXC TPI EUROPE	250	2018	2020	522704
XC-W TPI USA	250	2018	2020	522704
250 EGS	250	1998	1999	522698
250 EXC	250	1998	2016	522698
250 EXC 4T Racing	250	2002	2002	522698
250 EXC Sixdays	250	2009	2016	522698
250 Freeride R 2T	250	2014	2017	522698
250 SX	250	1998	2016	522698
250 SX-F ie4T	250	2013	2014	522698
250 EXC 4T Racing	250	2003	2006	522691
250 EXC-F 4T	250	2007	2010	522692
250 EXC-F 4T Sixdays	250	2009	2010	522692
250 EXC-F ie 4T	250	2011	2012	522692

Modèle	Cylindre	Année début	Année fin	Réf.
250 EXC-F ie 4T Sixdays	250	2011	2012	522692
250 SX-F 4T	250	2006	2010	522692
250 SX-F ie 4T	250	2011	2012	522692
250 EGS 11KW	250	1998	1999	522694
250 EGS M 12KW	250	1997	1997	522694
250 EXC Six Days	250	2004	2004	522694
250 SXS	250	2003	2007	522694
250 XC	250	2010	2014	522694
250 XC-W	250	2010	2016	522694
250 Freeride R	250	2016	2016	522694
EXC SIX DAYS TPI EUROPE	300	2018	2020	522704
EXC TPI EUROPE	300	2018	2020	522704
XC-W TPI USA - HANDLEBAR, CONTROLS	300	2018	2020	522704
300 EGS	300	1998	1999	522698
300 EXC	300	1998	2016	522698
300 EXC Sixdays	300	2009	2016	522698
300 EXC-E	300	2007	2007	522698
300 EXC-E Sixdays	300	2010	2011	522698
300 EGS 10KW	300	1998	1999	522694
300 EGS M 12KW	300	1997	1997	522694
300 XC	300	2010	2015	522694
300 XC-W	300	2010	2016	522694
300 XC-W Six Days	300	2014	2016	522694
350 EXC-F ie 4T	350	2012	2012	522692
350 EXC-F ie 4T Sixdays	350	2012	2012	522692
350 SX-F ie 4T	350	2011	2012	522692
380 EGS	380	1998	1999	522698
380 EXC	380	1998	2001	522698
380 SX	380	1998	2002	522698
390 Duke ABS	390	2014	2016	522690
400 EGS LC4	400	1994	1998	522693
400 EXC Racing	400	2004	2007	522691
400 EXC	400	2009	2011	522692
450 EXC Racing	450	2003	2007	522691
450 SMR Supermoto	450	2005	2007	522691
450 SX Racing	450	2003	2006	522691
450 EXC	450	2009	2011	522692
450 EXC ie	450	2012	2012	522692
450 EXC ie Sixdays	450	2012	2012	522692
450 EXC R	450	2008	2008	522692
450 EXC Sixdays	450	2009	2011	522692
450 SMR ie Supermoto	450	2013	2014	522692
450 SMR Supermoto	450	2008	2012	522692
450 SX-F Racing	450	2007	2012	522692
500 EXC ie	500	2012	2012	522692

Modèle	Cylindre	Année début	Année fin	Réf.
500 EXC ie Sixdays	500	2012	2012	522692
505 SX-F Racing	505	2007	2008	522692
530 EXC Racing	525	2003	2007	522691
530 MXC Desert Racing	525	2003	2005	522691
530 SMR Supermoto	525	2004	2005	522691
530 SX Racing	525	2003	2006	522691
530 XC Desert Racing	525	2006	2007	522691
530 EXC	530	2009	2011	522692
530 EXC R	530	2008	2008	522692
530 EXC Sixdays	530	2009	2011	522692
560 SMR Supermoto	560	2006	2007	522691
620 EGS LC4	620	1994	1998	522693
625 SMC Supermoto	625	2004	2006	522691
625 SXC	625	2003	2006	522691
LC4 640 DELLORTO	640	1998	2000	522705
640 Adventure LC4	640	2001	2007	522695
640 Duke II E	640	2000	2007	522695
640 LC4-E	640	2000	2006	522695
640 LC4-E Supermoto	640	2000	2006	522695
660 SMC Supermoto	660	2003	2006	522691
690 Rally Factory Replica	690	2009	2010	522691
690 Duke	690	2008	2011	522697
690 Duke ABS	690	2012	2012	522697
690 Duke R	690	2010	2012	522697
690 Enduro	690	2008	2010	522697
690 Enduro R	690	2009	2013	522697
690 SMC R Supermoto	690	2012	2013	522697
690 SMC Supermoto	690	2008	2011	522697
690 Supermoto	690	2007	2009	522697
690 Supermoto Prestige	690	2007	2007	522697
690 Supermoto R	690	2008	2010	522697
950 Adventure LC8	950	2003	2005	522699
950 Adventure S LC8	950	2003	2005	522699
950 Super Enduro R LC8	950	2006	2008	522699
950 Supermoto LC8	950	2006	2008	522700
950 Supermoto R LC8	950	2007	2008	522700
950 Supermoto LC8	950	2006	2008	522701
950 Supermoto R LC8	950	2007	2008	522701
990 Adventure LC8	990	2006	2007	522699
990 Super Duke LC8	990	2005	2011	522703
990 Adventure LC8 ABS	990	2006	2013	522699
990 Super Duke R LC8	990	2007	2013	522703
990 Adventure R LC8	990	2009	2013	522699
990 Adventure S LC8	990	2006	2008	522699
990 Supermoto LC8	990	2009	2010	522700
990 Supermoto SM R LC8	990	2009	2011	522700

Modèle	Cylindre	Année début	Année fin	Réf.
990 Supermoto SM R LC8 ABS	990	2012	2013	522700
990 Supermoto SM T LC8	990	2009	2011	522700
990 Supermoto SM T LC8 ABS	990	2011	2013	522700
990 Super Duke LC8	990	2005	2011	522702
990 Super Duke R LC8	990	2007	2013	522702
990 Supermoto LC8	990	2009	2010	522701
990 Supermoto R LC8	990	2009	2011	522701
990 Supermoto RA LC8 ABS	990	2012	2013	522701
990 Supermoto T LC8	990	2009	2011	522701
990 Supermoto TA LC8 ABS	990	2011	2013	522701
1190 RC8 R	1190	2009	2015	522689
1190 RC8	1190	2009	2011	522689
1190 RC8 R Red Bull	1190	2011	2011	522689
1190 RC8 R Track	1190	2011	2013	522689
1190 RC8	1190	2008	2011	522703
1190 RC8 R	1190	2009	2015	522703
1190 RC8 R Red Bull	1190	2011	2011	522703
1190 RC8 R Track	1190	2011	2013	522703
1190 RC8	1190	2008	2008	522702
KYMCO				
Agility 125 R12 Carry	125	2015	2017	522706
Agility 125 R12 MMC	125	2008	2011	522706
Agility 125 R12 One	125	2008	2009	522706
DJ 125 S	125	2012	2016	522706
Like 125	125	2009	2017	522706
Like 125 LX	125	2014	2015	522706
Agility 125 R12	125	2006	2007	522706
Agility 125 R12	125	2012	2016	522706
MBK				
Skyliner 125 H2O 4T	125	2003	2006	522710
Skyliner II 125 H2O 4T	125	2007	2009	522710
Skyliner 180 H2O 4T	180	2003	2003	522710
PEUGEOT				
Geopolis 125i H2O 4T	125	2006	2013	522714
Satelis I 125i H2O 4T	125	2006	2011	522714
Vivacity 3 L 125 4T RS	125	0	0	522726
PIAGGIO				
TPH 125 2T Typhoon	125	1995	1999	522760
TPH 125 X-R 2T Typhoon	125	2000	2003	522760
Fly II DT 125i AIR 4T 3V	125	2013	2015	522734
Fly II LEM 125i AIR 4T 3V	125	2012	2013	522734
Beverly RST 125i H2O 4T	125	2010	2015	522729
Liberty Delivery 125 AIR 4T	125	2007	2015	522741
MP3 ERL Yourban 125i H2O 4T	125	2001	2013	522746

Modèle	Cylindre	Année début	Année fin	Réf.
Liberty RST 125 AIR 4T 2V	125	2004	2007	522744
Liberty Sport 125 AIR 4T 2V	125	2006	2008	522744
Fly 125 AIR 4T 2V	125	2007	2011	522032
Fly 125 AIR 4T 2V	125	2007	2011	522028
Typhoon II 125 AIR 4T 2V	125	2010	2019	522028
Liberty Delivery 125 AIR 4T	125	2007	2015	522742
Fly II DT 125i AIR 4T 3V	125	2013	2015	522733
Fly II LEM 125i AIR 4T 3V	125	2012	2013	522733
Beverly RST 125i H2O 4T	125	2010	2015	522728
Liberty Delivery 125 AIR 4T 2V	125	2007	2015	522743
Liberty PTT 125 AIR 4T 2V	125	2005	2015	522743
Liberty 125	125	2001	2002	522735
Liberty 125i IGET AIR 4T 3V	125	2015	2020	522737
Liberty Sport 125i IGET AIR 4T 3V	125	2015	2020	522737
Liberty PTT 125 AIR 4T	125	2005	2015	522742
Liberty PTT 150 AIR 4T	125	2004	2008	522742
X9 125	125	2001	2002	522764
X9 Evolution 125	125	2003	2003	522764
Fly 125 AIR 4T 2V	125	2007	2011	522029
Liberty 125i LEM AIR 4T	125	2013	2014	522739
Typhoon II 125 AIR 4T 2V	125	2010	2017	522029
Liberty 125i IGET AIR 4T 3V	125	2015	2020	522736
Liberty Sport 125i IGET AIR 4T 3V	125	2015	2020	522736
Liberty PTT 125 AIR 4T	125	2005	2015	522741
Liberty RST 125 AIR 4T	125	2004	2008	522741
SKIPPER 125	125	2000	2002	522759
X7 125 H2O 4T	125	2008	2008	522763
X8 125 H2O 4T	125	2004	2006	522763
X8 125 H2O 4T	125	2007	2007	522763
X8 Street 125 AIR 4T	125	2006	2008	522763
XEvo 125 H2O 4T	125	2007	2016	522763
Liberty 125i LEM AIR 4T	125	2013	2014	522738
MP3 125 H2O 4T	125	2006	2008	522745
MP3 ERL Yourban 125i H2O 4T	125	2011	2013	522745
Fly II 150i AIR 4T 3V	150	2013	2018	522734
Liberty 150i LEM AIR 4T	150	2013	2014	522738
Liberty MOC 150 AIR 4T	150	2009	2013	522741
Liberty PTT 150 AIR 4T	150	2011	2011	522741
Liberty RST 150 AIR 4T	150	2008	2008	522741
Fly 150 AIR 4T 2V	150	2007	2012	522032
Fly 150 AIR 4T 2V	150	2007	2012	522028
Liberty MOC 150 AIR 4T	150	2009	2013	522742
Liberty PTT 150 AIR 4T	150	2011	2011	522742
Liberty RST 150 AIR 4T	150	2008	2008	522742

Modèle	Cylindre	Année début	Année fin	Réf.
Fly II 150i AIR 4T 3V	150	2013	2018	522733
Liberty PTT 150 AIR 4T 2V	150	2011	2011	522743
Liberty 150	150	2001	2002	522735
Liberty 150i IGET AIR 4T 3V	150	2015	2020	522737
Liberty Sport 150i IGET AIR 4T 3V	150	2015	2020	522737
Fly 150 AIR 4T 2V	150	2007	2012	522029
Liberty 150i LEM AIR 4T	150	2013	2014	522739
Liberty 150i IGET AIR 4T 3V	150	2015	2020	522736
Liberty Sport 150i IGET AIR 4T 3V	150	2015	2020	522736
SKIPPER 150	150	2000	2002	522759
X8 Street 150 AIR 4T	150	2006	2008	522763
X9 Amalfi 180	180	2000	2003	522764
Liberty RST 200 AIR 4T 2V	200	2004	2008	522744
Liberty Sport 200 AIR 4T 2V	200	2006	2007	522744
X9 200	200	2002	2003	522764
X9 Evolution 200	200	2003	2003	522764
X8 200 H2O 4T	200	2004	2007	522763
X9 Evolution 250	250	2004	2004	522764
MP3 LT 250i H2O 4T	250	2008	2009	522747
MP3 RL 250i H2O 4T	250	2006	2008	522747
MP3 RL MIC 250i H2O 4T	250	2008	2010	522747
MP3 LT 250i H2O 4T	250	2008	2009	522745
MP3 RL 250i H2O 4T	250	2006	2008	522745
MP3 RL MIC 250i H2O 4T	250	2008	2010	522745
Beverly RST 300i H2O 4T	300	2010	2016	522729
MP3 ERL Yourban 300i H2O 4T	300	2011	2015	522746
MP3 LT Yourban 300i H2O 4T	300	2011	2018	522746
MP3 LT 300i H2O 4T	300	2009	2014	522749
MP3 LT Sport 300i H2O 4T	300	2011	2014	522749
Beverly RST 300i H2O 4T	300	2010	2016	522728
MP3 LT Business 300i H2O 4T	300	2014	2018	522753
MP3 LT Sport 300i H2O 4T	300	2014	2018	522753
MP3 LT Business 300i H2O 4T	300	2014	2018	522752
MP3 LT 300i H2O 4T	300	2009	2014	522748
MP3 LT Sport 300i H2O 4T	300	2011	2014	522748
MP3 LT Sport 300i H2O 4T	300	2014	2018	522752
MP3 LT Yourban 300i H2O 4T	300	2011	2018	522745
MP3 ERL Yourban 300i H2O 4T	300	2011	2015	522745
X10 350	350	2012	2016	522762
X10 350	350	2012	2016	522761
MP3 LT 400i H2O 4T	400	2008	2010	522750
MP3 LT Sport 400i H2O 4T	400	2008	2010	522750
MP3 LT Touring 400i H2O 4T	400	2011	2011	522750

Modèle	Cylindre	Année début	Année fin	Réf.
MP3 RL 400i H2O 4T	400	2007	2008	522750
MP3 RL MIC 400i H2O 4T	400	2008	2010	522750
MP3 LT 400i H2O 4T	400	2008	2010	522751
MP3 LT Sport 400i H2O 4T	400	2008	2010	522751
MP3 LT Touring 400i H2O 4T	400	2011	2011	522751
MP3 RL 400i H2O 4T	400	2007	2008	522751
MP3 RL MIC 400i H2O 4T	400	2008	2010	522751
MP3 LT Business 500i H2O 4T	500	2011	2013	522750
MP3 LT Sport 500i H2O 4T	500	2011	2013	522750
MP3 RL Business 500i H2O 4T	500	2011	2012	522750
MP3 RL Sport 500i H2O 4T	500	2010	2012	522750
MP3 LT Business 500i H2O 4T	500	2011	2013	522751
MP3 LT Sport 500i H2O 4T	500	2011	2013	522751
MP3 RL Business 500i H2O 4T	500	2011	2012	522751
MP3 RL Sport 500i H2O 4T	500	2010	2012	522751
MP3 LT Business 500i H2O 4T	500	2011	2013	522751
MP3 RL Sport 500i H2O 4T	500	2010	2012	522751
MP3 RL 500i H2O 4T	500	2007	2009	522209
MP3 RL 500i H2O 4T	500	2007	2009	522210

ROYAL ENFIELD

Bullet C5 Chrome 49 State	500	2014	2014	522772
Bullet C5 Chrome California	500	2014	2014	522772
Bullet C5 Classic	500	2011	2013	522772
Bullet C5 Classic 49 State	500	2014	2014	522772
Bullet C5 Classic California	500	2014	2014	522772
Bullet C5 Classic Chrome	500	2013	2013	522772
Bullet C5 Classic Chrome Special	500	2013	2013	522772
Bullet C5 Classic Military	500	2013	2013	522772
Bullet C5 Classic Special	500	2013	2013	522772
Bullet C5 Military	500	2011	2013	522772
Bullet C5 Military 49 State	500	2014	2014	522772
Bullet C5 Military California	500	2014	2014	522772
Bullet G5 Classic	500	2011	2013	522772
Bullet G5 Deluxe	500	2011	2013	522772
Bullet G5 Deluxe EFI 49 State	500	2014	2014	522772
Bullet G5 Deluxe EFI California	500	2014	2014	522772
Bullet G5 Electra Deluxe	500	2013	2013	522772
Bullet G5 Electra Standard	500	2013	2013	522772
Bullet 500 B5	500	2012	2013	522772
Bullet 500 B5 EFI	500	2014	2014	522772
Bullet 500 Classic C5	500	2009	2011	522772
Bullet 500 Classic G5	500	2009	2011	522772
Bullet 500 Deluxe ES	500	2009	2009	522772
Bullet 500 Deluxe G5	500	2009	2012	522772
Bullet 500 EFI	500	2017	2018	522772
Bullet 500 Military C5	500	2011	2012	522772
Bullet 500 Military G5	500	2010	2010	522772

Modèle	Cylindre	Année début	Année fin	Réf.
Bullet 500 UCE E5	500	2010	2011	522772
Bullet C5 Chrome	500	2011	2013	522772
SHERCO				
ENDURO 250 SEF RACING	250	2019	2021	522773
ENDURO 250 SEF FACTORY	250	2019	2022	522773
ENDURO 300 SEF SIX DAYS	300	2017	2018	522773
ENDURO 300 SEF FACTORY	300	2017	2022	522773
ENDURO 450 SEF RACING	450	2017	2021	522773
ENDURO 450 SEF FACTORY	450	2017	2022	522773
ENDURO 500 SEF RACING	500	2019	2021	522773
ENDURO 500 SEF FACTORY	500	2019	2022	522773
ENDURO 500 SCF-R CROSS COUNTRY	500	2019	2019	522773
SUZUKI				
RV 125	125	1970	1981	522915
TS 125 ER	125	1973	1981	522915
TS 185	125	1973	1973	522915
DR 125 S	125	1985	1994	522782
DR 125 SE	125	1995	2000	522782
DR 125 SEU	125	1997	2000	522782
RM 125	125	1983	1983	522907
RM 125	125	1994	1994	522908
RM 125 (pour carbu KEIHIN PJ34-36 ou PWK 35)	125	1982	1993	522908
GN 125 Z	125	1983	1983	522794
RV 125 Van Van	125	2007	2017	522918
RV 125 Van Van	125	2003	2006	522916
GN 125	125	1991	1997	522793
GT 125	125	1974	1979	522883
GT 125 E	125	1978	1979	522883
RV 125 Van Van	125	2007	2017	522917
AN 125	125	0	0	522775
GT 125	125	1974	1979	522882
GT 125 E	125	1978	1979	522882
VL 125	125	2000	2007	522940
VL 125	125	2000	2007	522939
RM 125	125	2001	2007	522909
TS 125 ERZ	125	1982	1986	522936
GZ 125 Marauder	125	1998	2011	522896
GT 185	185	1973	1977	522884
GT 200	200	0	0	522885
SB 200	200	0	0	522885
GT 250	250	1973	1977	522887
GW 250 INAZUMA	250	2012	2017	522895
RM 250	250	1993	1994	522910
RMX 250	250	1993	1998	522910

Modèle	Cylindre	Année début	Année fin	Réf.
RM 250 (pour carbu KEIHIN PJ34-36 ou PWK 35)	250	1982	1992	522908
RMX 250 (pour carbu KEIHIN PJ34-36 ou PWK 35)	250	1989	1998	522908
RM 250	250	1995	1996	522911
K250 TS	250	1970	1970	522898
GSX 250	250	1980	1981	522829
GSX 250 E	250	1980	1983	522829
GSX 250 EU	250	1980	1981	522829
GSX 250 U	250	1980	1981	522829
RM-Z 250	250	2008	2013	522914
GN 250	250	1985	1999	522795
GNX 250 E	250	1982	1984	522795
RM-Z 250	250	2007	2007	522913
GT 250	250	1979	1981	522888
GT 250 E	250	1979	1981	522888
VL 250	250	2000	2007	522940
RG 250 GAMMA 3 FG	250	0	0	522905
RM 250	250	2005	2012	522912
VL 250	250	2000	2007	522939
RM-Z 250	250	2004	2006	522602
TS 250	250	1969	1979	522937
TS 250 ER	250	1980	1983	522937
TS 250 X	250	1984	1989	522937
GW 250 INAZUMA	250	2012	2017	522894
RM 250	250	2001	2007	522909
GT 250 X7	250	0	0	522889
GT 250	250	1972	1977	522886
DR 350 SE	350	1994	1998	522784
DR 350 S	350	1990	1994	522783
DR 350 SH	350	1992	1994	522783
GSX 400 E	400	1980	1982	522829
GSX 400 S	400	1980	1981	522829
GSX 400 E	400	1983	1987	522830
GSX 400 S	400	1983	1987	522830
GS 400 X	400	1977	1977	522797
GSX 400 FE Katana	400	1981	1983	522831
AN 400 Burgman	400	1999	2002	522777
GS 400 X	400	1977	1977	522798
AN 400	400	1999	2002	522776
RMX 450 Z	450	2010	2016	522914
RM-Z 450	450	2008	2014	522914
RM-Z 450	450	2007	2007	522913
GS 450 S	450	1980	1981	522829
RG 500 Gamma 4 Units	500	1986	1986	522906
GS 500	500	2001	2006	522800

Modèle	Cylindre	Année début	Année fin	Réf.
GS 500 F	500	2004	2006	522800
GS 500 FH	500	2007	2008	522800
GS 500 FM	500	2007	2008	522800
RG 500 Gamma	500	1986	1986	522906
DR 500 S	500	1981	1983	522785
GS 500 FU	500	2004	2006	522800
GS 500 H	500	2007	2008	522800
GS 500 HU	500	2007	2008	522800
GS 500 U	500	2001	2006	522800
GS 500 E	500	1990	1993	522801
GS 500	500	2001	2006	522799
GS 500 F	500	2004	2006	522799
GS 500 FH	500	2007	2008	522799
GS 500 FM	500	2007	2008	522799
GS 500 FU	500	2004	2006	522799
GS 500 H	500	2007	2008	522799
GS 500 HU	500	2007	2008	522799
GS 500 U	500	2001	2006	522799
GT 500	500	1976	1979	522890
GS 550 (ROUE RAYON)	550	1977	1979	522803
GS 550 E (ROUE BATON)	550	1978	1979	522803
GSX 550 EF carenée	550	1984	1987	522832
GSX 550 E (modèle F)	550	1983	1984	522832
GSX 550 ES semie-carenée	550	1983	1987	522832
GS 550 E	550	1977	1979	522802
GS 550 M Katana	550	1981	1983	522829
GS 550 M Katana	550	1982	1983	522829
GSF 600 Bandit	600	1995	1999	522811
GSF 600 S Bandit	600	1996	1999	522811
GSF 600 SU Bandit	600	1996	1999	522811
GSF 600 U Bandit	600	1995	1999	522811
GSX-R 600	600	1997	2000	522853
GSX-R 600	600	2001	2001	522856
GSF 600 Bandit	600	2000	2004	522813
GSF 600 S Bandit	600	2000	2004	522813
GSF 600 SU Bandit	600	2000	2004	522813
GSF 600 U Bandit	600	2000	2004	522813
DR 600 S	600	1985	1985	522787
DR 600 SU	600	1985	1985	522787
DR 600 S	600	1985	1985	522786
DR 600 SU	600	1985	1985	522786
GSF 600 Bandit	600	1995	1999	522810
GSF 600 S Bandit	600	1996	1999	522810
GSX-R 600	600	2008	2010	522865
GSX-R 600 U2	600	2008	2008	522865
GSX-R 600 U3	600	2007	2008	522865

Modèle	Cylindre	Année début	Année fin	Réf.
GSX-R 600 UE	600	2009	2010	522865
GSX-R 600 UF	600	2009	2010	522865
GSF 600 SU Bandit	600	1996	1999	522810
GSF 600 U Bandit	600	1995	1999	522810
GSX-R 600	600	2006	2007	522863
GSX-R 600	600	2006	2007	522862
GSR 600	600	2006	2010	522819
GSR 600 U	600	2006	2010	522819
GSR 600 A ABS	600	2007	2011	522819
GSR 600 UA ABS	600	2007	2011	522819
GSX-R 600	600	2004	2005	522860
GSX-R 600 U2	600	2004	2005	522860
GSX-R 600 U3	600	2004	2005	522860
GSX-R 600 X Anniversaire	600	2005	2005	522860
GSX-R 600 XU2 Anniversaire	600	2005	2005	522860
RF 600 R	600	1995	1996	522903
GSX-R 600	600	2008	2010	522864
GSX-R 600 U2	600	2008	2008	522864
GSX-R 600 U3	600	2007	2008	522864
GSX-R 600 UE	600	2009	2010	522864
GSX-R 600 UF	600	2009	2010	522864
GSX-R 600	600	2004	2005	522861
GSX-R 600 U2	600	2004	2005	522861
GSX-R 600 U3	600	2004	2005	522861
GSX-R 600 X Anniversaire	600	2005	2005	522861
GSX-R 600 XU2 Anniversaire	600	2005	2005	522861
GSR 600	600	2006	2010	522818
GSX-R 600 XU3 Anniversaire	600	2005	2005	522861
GSR 600 A ABS	600	2007	2011	522818
GSR 600 U	600	2006	2010	522818
GSR 600 UA ABS	600	2007	2011	522818
GSX-R 600	600	2001	2001	522857
RF 600 R	600	1995	1996	522904
RF 600 RU	600	1995	1996	522904
GSX 600 F	600	1998	2001	522833
GSX 600 FU	600	1998	2001	522833
GSX 600 FU	600	1993	1997	522835
GSX 600 FU2	600	1992	1997	522835
GSX-R 600 XU3 Anniversaire	600	2005	2005	522860
GSF 600 Bandit	600	2000	2004	522812
GSF 600 S Bandit	600	2000	2004	522812
GSF 600 SU Bandit	600	2000	2004	522812
GSF 600 U Bandit	600	2000	2004	522812
GSX 600 F	600	1998	2001	522834
GSX 600 FU	600	1998	2001	522834
GSX-R 600	600	2002	2003	522859

MOTEUR

CYCLE

PNEUMATIQUE

ATELIER

ACCESSOIRES

ÉLECTRICITÉ

FILTRATION

FREINAGE

TRANSMISSION

Modèle	Cylindre	Année début	Année fin	Réf.
GSX-R 600	600	2002	2003	522858
GSX-R 600	600	1997	2000	522855
GSX 600 F	600	1990	1997	522835
GSX-R 600	600	1997	1999	522852
GSX-R 600	600	1997	2000	522854
GSX-R 600 U2	600	2006	2007	522862
GSX-R 600 U3	600	2006	2006	522862
RF 600 R	600	1993	1994	522902
RF 600 R	600	1993	1994	522901
LS 650 P Savage guidont haut	650	1996	2000	522900
XF 650 FREEWIND	650	1997	2001	522954
SV 650 S	650	1999	2002	522931
SV 650 SU	650	1999	2002	522931
SV 650 S	650	2003	2016	522932
SV 650 SA ABS	650	2007	2010	522932
SV 650 SU	650	2003	2010	522932
SV 650 SUA ABS	650	2007	2008	522932
SV 650 S	650	1999	2002	522930
SV 650 SU	650	1999	2002	522930
SFV 650 Gladius	650	2009	2009	522923
SV 650	650	2003	2009	522928
SV 650	650	2017	2017	522923
SV 650 A ABS	650	2007	2009	522928
SV 650 ABS	650	2017	2017	522923
SV 650 U	650	2002	2009	522928
SV 650 UA ABS	650	2007	2009	522928
SV 650	650	2003	2009	522929
SV 650 A ABS	650	2007	2009	522929
SV 650 U	650	2002	2009	522929
SV 650 UA ABS	650	2007	2009	522929
SFV 650 GLADIUS	650	2009	2009	522922
SFV 650	650	2015	2015	522922
SV 650	650	2017	2017	522922
SV 650	650	1999	2002	522925
SV 650 U	650	1999	2001	522925
DL V-Strom -650	650	2010	2011	522780
GSF 650 A Bandit ABS	650	2005	2006	522815
GSF 650 Bandit	650	2005	2006	522815
GSF 650 S Bandit	650	2005	2006	522815
GSF 650 SA Bandit ABS	650	2005	2006	522815
GSF 650 A Bandit ABS	650	2005	2006	522814
DR 650 R	650	1992	1995	522789
GSF 650 S Bandit	650	2007	2008	522817
GSF 650 Bandit	650	2005	2006	522814
DR 650 RE	650	1994	1995	522789
GSF 650 SA Bandit ABS	650	2007	2008	522817

Modèle	Cylindre	Année début	Année fin	Réf.
GSF 650 S Bandit	650	2005	2006	522814
DR 650 REU	650	1994	1995	522789
GSF 650 SU Bandit	650	2007	2008	522817
GSF 650 SA Bandit ABS	650	2005	2006	522814
DR 650 RU	650	1991	1993	522789
GSF 650 SUA Bandit ABS	650	2007	2008	522817
GSF 650 SU Bandit	650	2005	2006	522814
GSF 650 SUA Bandit ABS	650	2005	2006	522814
GSF 650 U Bandit	650	2005	2006	522814
GSF 650 UA Bandit ABS	650	2005	2006	522814
GSF 650 S Bandit	650	2007	2008	522816
GSF 650 SA Bandit ABS	650	2007	2008	522816
GSF 650 SU Bandit	650	2007	2008	522816
GSF 650 SUA Bandit ABS	650	2007	2008	522816
DL V-Strom 650	650	2010	2011	522781
SV 650	650	1999	2002	522926
LS 650 F Savage	650	1991	2000	522899
GS 650 G Katana	650	1981	1982	522829
GS 650 G Katana	650	1982	1982	522829
SV 650	650	2003	2009	522927
SV 650 A ABS	650	2007	2009	522927
SV 650 U	650	2002	2009	522927
SV 650 UA ABS	650	2007	2009	522927
DR 650 R	650	1992	1995	522788
GSF 650 SU Bandit	650	2005	2006	522815
GSF 650 SUA Bandit ABS	650	2005	2006	522815
GSF 650 U Bandit	650	2005	2006	522815
GSF 650 UA Bandit ABS	650	2005	2006	522815
GSX-R 750 W	750	1992	1995	522878
GSX 750 Inazuma	750	1998	2003	522838
GSX-R 750	750	1996	1997	522853
GSX-R 750 W	750	1992	1995	522879
GSX 750 Inazuma	750	1998	2003	522838
GSX-R 750	750	2008	2010	522865
GSX-R 750 U2	750	2008	2008	522865
GSX-R 750 UF	750	2009	2010	522865
GSX-R 750	750	1986	1987	522868
GSX-R 750 R Special Edition	750	1986	1986	522868
GSX-R 750 X	750	1986	1987	522868
GSX 750 E (ROUE BATON)	750	1980	1981	522836
GSX 750 (ROUE RAYON)	750	1980	1981	522836
GSX 750 EG Silver Suzi (ROUE BATON)	750	1980	1980	522836
GSX 750 Inazuma	750	1998	2003	522839
GSX 750 E (ROUE BATON)	750	1982	1983	522829
GS 750 (ROUE RAYON)	750	1977	1977	522804

Modèle	Cylindre	Année début	Année fin	Réf.
GS 750 D (ROUE RAYON)	750	1977	1977	522804
GSX-R750	750	2002	2003	522881
GSX-R 750	750	1990	1990	522871
GSX-R 750	750	2000	2001	522873
GSX-R 750 U1	750	2000	2001	522873
GSX-R 750	750	2008	2010	522864
GSX-R 750	750	2004	2005	522861
GSX-R 750 U2	750	2004	2005	522861
GSX-R 750 X	750	2005	2005	522861
GSX-R 750 XU2	750	2005	2005	522861
GSX 750 F	750	1998	2006	522833
DR 750 SU Big	750	1988	1989	522790
GSX-R 750	750	1988	1989	522870
GSX 750 F	750	1989	1997	522837
GSX-R 750	750	2004	2005	522860
GSX-R 750 U2	750	2004	2005	522860
GSX-R 750 X	750	2005	2005	522860
GSX-R 750 XU2	750	2005	2005	522860
VS 750 GLP Intruder guidont haut	750	1986	1991	522945
DR 750 S Big	750	1988	1989	522790
GSX-R 750 U2	750	2008	2008	522864
GSX-R 750 UF	750	2009	2010	522864
GSX 750 F	750	1998	2006	522834
GSX-R 750	750	2002	2003	522875
GSX-R 750	750	2000	2001	522874
GSX-R 750 U1	750	2000	2001	522874
GT 750	750	1973	1977	522891
GSX-R 750	750	1998	1999	522872
GSX-R750	750	1996	1999	522880
GSX-R 750	750	2006	2007	522876
GSX-R 750 U2	750	2006	2007	522876
GT 750	750	1973	1977	522892
GSX-R 750	750	1996	1999	522855
GSX-R 750	750	1985	1985	522867
GSX-R 750	750	1985	1985	522866
GSX-R 750	750	1996	1999	522854
GT 750	750	1973	1977	522893
GSX-R 750	750	2006	2007	522862
GSX-R 750 U2	750	2006	2007	522862
GSX-R 750	750	1986	1987	522869
GSX-R 750 X	750	1986	1987	522869
GSX-R 750 R Special Edition	750	1986	1986	522869
GSX-R 750 U1	750	2000	2003	522877
GSX-R 750	750	2000	2003	522877
VZ 800 MARAUDER	800	1997	2004	522948

Modèle	Cylindre	Année début	Année fin	Réf.
VX 800	800	1990	1997	522946
VX 800 U	800	1990	1997	522946
DR 800 S Big	800	1990	1990	522791
DR 800 SU Big	800	1990	1990	522791
VZ 800 MARAUDER	800	1997	2004	522949
VL 800	800	2007	2008	522941
VS 800 GL Intruder	800	1992	1994	522945
VL 800 C 800 C Intruder (ROUE BATON)	800	2007	2008	522942
VL 800 C 800 Intruder (ROUE RAYON)	800	2007	2008	522942
VL 800 C 800 UE Intruder (ROUE RAYON)	800	2007	2008	522942
DR 800 S Big	800	1993	1999	522792
DR 800 SU Big	800	1993	1999	522792
VZ 800	800	1997	2004	522947
GS 850 G	850	1979	1986	522805
RF 900 R	900	1994	1997	522903
GS 1000 S	1000	1979	1979	522796
SV 1000 S	1000	2003	2005	522932
SV 1000 S2	1000	2003	2005	522932
SV 1000 SZ	1000	2005	2005	522932
SV 1000 SZ2	1000	2005	2005	522932
GS 1000 E / H (ROUE BATON)	1000	1980	1980	522836
GS 1000 (ROUE RAYON)	1000	1980	1980	522836
GSX-R1000	1000	2005	2006	522845
GSX-R 1000 U2	1000	2005	2006	522845
SV 1000	1000	2003	2005	522928
SV 1000 U2	1000	2003	2005	522928
SV 1000	1000	2003	2005	522929
SV 1000 U2	1000	2003	2005	522929
GSX-R1000	1000	2005	2006	522844
GSX-R 1000 U2	1000	2005	2006	522844
GSX-R1000	1000	2002	2002	522881
TL 1000 S	1000	1997	2000	522934
GSX-R 1000	1000	2001	2001	522873
GSX-R 1000 U1	1000	2001	2001	522873
GSX-R 1000 U2	1000	2001	2001	522873
GSX-R 1000	1000	2003	2004	522841
TL 1000 S	1000	1997	2001	522935
GS 1000 E (ROUE BATON)	1000	1978	1979	522805
GS 1000 G	1000	1980	1981	522805
GS 1000 H (ROUE BATON)	1000	1978	1979	522805
GS 1000 (ROUE RAYON)	1000	1978	1979	522805
GSX-R 1000	1000	2003	2004	522842
GSX-R1000	1000	2002	2002	522875
GSX-R 1000	1000	2001	2001	522874

MOTEUR

CYCLE

PNEUMATIQUE

ATELIER

ACCESSOIRES

ÉLECTRICITÉ

FILTRATION

FREINAGE

TRANSMISSION

Modèle	Cylindre	Année début	Année fin	Réf.
GSX-R 1000 U1	1000	2001	2001	522874
GSX-R 1000 U2	1000	2001	2001	522874
GSX-R 1000	1000	2005	2006	522843
DL 1000 V-Strom	1000	2002	2010	522779
SV 1000	1000	2003	2005	522927
SV 1000 U2	1000	2003	2005	522927
TL 1000 R	1000	1998	1999	522933
GSX-R 1000	1000	2001	2004	522840
GSX-R 1000 U1	1000	2001	2002	522840
GSX-R 1000 U2	1000	2001	2002	522840
GSX-R 1100 W	1100	1993	1994	522878
GSX-R 1100	1100	1991	1992	522848
GSX-R 1100 W	1100	1993	1994	522879
GSX-R 1100	1100	1986	1988	522846
GSX 1100 ES semie-carenée	1100	1983	1983	522829
GSX 1100 EX (ROUE BATON)	1100	1983	1983	522829
GSX 1100 E	1100	1986	1987	522830
GSX 1100 E (ROUE BATON)	1100	1980	1981	522830
GSX 1100 EF carenée	1100	1984	1987	522830
GSX 1100 ES semie-carenée	1100	1984	1987	522830
GSX 1100 (ROUE RAYON)	1100	1980	1981	522830
GSX-R 1100	1100	1989	1990	522870
GSX 1100 F	1100	1988	1988	522790
GSX 1100 F	1100	1989	1996	522820
GSX-R 1100	1100	1991	1992	522847
GSX 1100 G	1100	1991	1996	522821
GSX-R 1100 W	1100	1995	1998	522850
GSX 1100 E	1100	1983	1983	522829
GSX 1100 E (ROUE BATON)	1100	1982	1982	522829
GSX-R 1100	1100	1993	1998	522849
GSF 1200 Bandit	1200	2001	2006	522809
GSF 1200 S Bandit	1200	2001	2005	522809
GSF 1200 SZ Bandit ABS	1200	2005	2005	522809
GSF 1200 Bandit	1200	2001	2006	522808
GSF 1200 S Bandit	1200	2001	2005	522808
GSF 1200 SZ Bandit ABS	1200	2005	2005	522808
GSF 1200 Bandit	1200	1996	2000	522806
GSF 1200 S Bandit	1200	1996	2000	522806
GSF 1200 SA Bandit ABS	1200	1997	2000	522806
GSX 1200 Inazuma	1200	1999	2000	522822
GSX 1200 Inazuma	1200	1999	2000	522823
GSF 1200 Bandit	1200	1996	2000	522807
GSF 1200 S Bandit	1200	1996	2000	522807
GSF 1200 SA Bandit ABS	1200	1997	2000	522807
GSF 1250 S Bandit	1250	2007	2010	522817
GSF 1250 SA Bandit ABS	1250	2007	2014	522817

Modèle	Cylindre	Année début	Année fin	Réf.
GSX 1250 FA ABS	1250	2010	2015	522817
GSF 1250 S Bandit	1250	2007	2010	522816
GSF 1250 SA Bandit ABS	1250	2007	2014	522816
Hayabusa GSX 1300 R	1300	1999	2003	522897
GSX-R 1300 Hayabusa	1300	1999	2001	522851
GSX 1300 R	1300	1999	2005	522825
GSX 1300 BK B-King	1300	2008	2008	522824
GSX 1300 R Hayabusa	1300	1999	2007	522824
GSX 1300 RUI Hayabusa	1300	1999	2006	522824
GSX 1300 RU2 Hayabusa	1300	1999	2006	522824
GSX 1300 RU2Z Hayabusa	1300	2007	2007	522824
GSX 1300 RUZ Hayabusa SE	1300	2003	2003	522824
GSX 1300 RZ Hayabusa	1300	2007	2007	522824
GSX 1300 RZ Hayabusa SE	1300	2003	2003	522824
GSX 1300 R	1300	1999	2005	522826
VS 1400 GLP Intruder guidont haut	1400	1987	1994	522943
VS 1400 GLP Intruder guidont haut	1400	1995	2003	522944
GSX 1400	1400	2002	2003	522827
GSX 1400	1400	2004	2007	522828
VZR 1800	1800	2006	2008	522951
VZR 1800	1800	2006	2008	522950
VZR 1800	1800	2011	2020	522952
VZR 1800	1800	2011	2020	522953
SYM				
GTS 125 H2O 4T	125	2005	2008	522957
GTS Evo 125 H2O 4T	125	2009	2010	522957
GTS Evo 125 i H2O 4T	125	2010	2013	522957
GTS 250	250	0	0	522958
TRIUMPH				
Speed Four 600	600	2003	2006	522989
TT 600	600	2000	2003	523020
Daytona 600	600	2003	2004	522977
Street Triple 675 R	675	2009	2012	523007
Street Triple 675	675	2013	2013	523006
Street Triple 675 ABS	675	2013	2014	523006
Street Triple 675 R	675	2013	2013	523006
Street Triple 675 R ABS	675	2013	2014	523006
Daytona 675	675	2013	2014	522979
Daytona 675 R	675	2011	2014	522979
Street Triple 675	675	2008	2012	523007
Daytona 675	675	2006	2012	522978
Bonneville 800	800	2002	2007	522973
800 T100 Centennial	800	2002	2002	522963
Bonneville 800	800	2001	2006	522963

Modèle	Cylindre	Année début	Année fin	Réf.
Bonneville 800 America	800	2002	2006	522963
Bonneville 800 Black	800	2006	2006	522963
Bonneville 800 T100	800	2003	2004	522963
Tiger 800	800	2011	2013	523017
Tiger 800 ABS	800	2011	2014	523017
Tiger 800 XC	800	2011	2013	523017
Tiger 800 XC ABS	800	2011	2014	523017
Speedmaster 800	800	2003	2004	522994
Speedmaster 800	800	2003	2004	522995
Bonneville 800	800	2001	2006	522972
Bonneville 800 America	800	2002	2006	522972
Bonneville 800 Black	800	2006	2006	522972
Bonneville 800 T100	800	2003	2004	522972
800 T100 Centennial	800	2002	2002	522972
Scrambler 865	865	2007	2007	522988
Scrambler 865 EFI	865	2008	2009	522988
Bonneville 865 EFI	865	2008	2015	522974
Bonneville 865 EFI T100	865	2008	2015	522974
Bonneville 865 EFI T100 50th	865	2009	2009	522974
Bonneville 865 EFI T100 McQueen Edition	865	2012	2012	522974
Bonneville 865 T100	865	2005	2007	522963
Thruxton 865	865	2004	2007	523008
Thruxton 865 EFI	865	2008	2015	523009
Thruxton 865 EFI ACE	865	2015	2015	523009
Speedmaster 865 EFI	865	2012	2015	522998
Scrambler 865	865	2006	2006	522987
Bonneville 865 SE EFI	865	2009	2013	522976
Scrambler 865 EFI	865	2010	2015	522976
America 865 EFI	865	2011	2015	522971
Bonneville 865	865	2007	2007	522963
Bonneville 865 Black	865	2007	2007	522963
Thruxton 865 EFI	865	2008	2015	523010
America 865 EFI	865	2008	2010	522969
America 865 EFI	865	2008	2010	522968
Speedmaster 865	865	2005	2007	522994
Speedmaster 865	865	2005	2007	522995
Speedmaster 865 EFI	865	2008	2011	522996
Bonneville 865 T100	865	2005	2007	522972
Speedmaster 865 EFI	865	2012	2015	522999
Speedmaster 865 EFI	865	2008	2011	522997
America 865 EFI	865	2011	2015	522970
America 865 LT EFI	865	2014	2015	522970
America 865	865	2007	2007	522967
America 865 LT EFI	865	2014	2015	522967
Bonneville 865	865	2007	2007	522972

Modèle	Cylindre	Année début	Année fin	Réf.
Bonneville 865 Black	865	2007	2007	522972
Bonneville 865 EFI T100 McQueen Edition	865	2012	2012	522975
Bonneville 865 EFI T100 50th	865	2009	2009	522975
Bonneville 865 EFI T100	865	2008	2012	522975
Daytona 900	900	1993	1996	522980
Daytona 900 Super III	900	1994	1996	522980
Thunderbird 900	900	1995	1997	523015
Tiger 900 EFI	900	1999	2001	523018
Trident 900	900	1992	1998	523019
Adventurer 900	900	1997	1997	522965
Adventurer 900	900	1998	1998	522966
Legend 900 TT	900	1999	2001	523015
Speed Triple 900 EFI	900	1997	1998	522992
Adventurer 900	900	1999	2001	523015
Thunderbird 900	900	1998	2003	522965
Thunderbird 900 Sport	900	1997	2004	522965
Tiger 900	900	1993	1998	522965
Trophy 900	900	1996	2001	522965
Sprint 900 Executive	900	1997	1999	523002
Sprint 900 Sport	900	1997	1997	523002
Sprint 900 Trident	900	1993	1998	523002
Adventurer 900	900	1996	1996	522964
Speed Triple 900	900	1994	1996	522991
Tiger 955 i	955	2005	2006	523018
Tiger 955 i S(ROUE RAYON)	955	2001	2004	523018
Speed Triple 955 EFI	955	1999	2001	522992
Daytona 955 i monobras	955	1997	2001	522992
Daytona 955 i monobras	955	2002	2002	522992
Sprint 955 RS monobras	955	2002	2004	523003
Sprint 955 S	955	2002	2004	523003
Sprint 955 ST	955	1999	2001	523005
Speed Triple 955 EFI	955	2002	2004	522993
Sprint 955 RS bras oscillant bilatéral	955	2000	2002	523004
Daytona 955 i monobras	955	2003	2006	522993
Daytona 955 i bras oscillant bilatéral	955	2002	2002	522993
Sprint 1050 GT ABS	1050	2010	2014	523000
Tiger 1050	1050	2007	2010	523016
Tiger 1050 ABS	1050	2007	2011	523016
Tiger 1050 SE	1050	2010	2012	523016
Tiger 1050 Sport ABS	1050	2013	2014	523016
1050 SE ABS	1050	2011	2013	523016
Sprint 1050 ST	1050	2005	2010	523001
Sprint 1050 ST ABS	1050	2006	2010	523001
Speed Triple 1050	1050	2005	2010	523001

Modèle	Cylindre	Année début	Année fin	Réf.
Speed Triple 1050	1050	2011	2013	522990
Speed Triple 1050 ABS	1050	2011	2014	522990
Speed Triple 1050 R ABS	1050	2012	2014	522990
Trophy 1200	1200	1994	2003	523015
Thunderbird 1600	1600	2009	2013	523011
Thunderbird 1600	1600	2009	2013	523012
Thunderbird 1600 ABS	1600	2010	2014	523011
Thunderbird 1600 ABS	1600	2010	2014	523012
Thunderbird 1700 Storm	1700	2011	2013	523011
Thunderbird 1700 Storm	1700	2011	2013	523012
Thunderbird 1700 Storm ABS	1700	2011	2014	523011
Thunderbird 1700 Storm ABS	1700	2011	2014	523012
Thunderbird 1700 Commander ABS	1700	2014	2014	523014
Thunderbird 1700 LT ABS	1700	2014	2014	523014
Thunderbird 1700 Commander ABS	1700	2014	2014	523013
Thunderbird 1700 LT ABS	1700	2014	2014	523013
Rocket 2300 III CLASSIC	2300	2006	2009	522983
Rocket 2300 III	2300	2004	2009	522982
Rocket 2300 III Roadster ABS	2300	2010	2014	522982
Rocket 2300 III	2300	2004	2009	522981
Rocket 2300 III CLASSIC	2300	2006	2009	522984
Rocket 2300 III Roadster ABS	2300	2010	2014	522981
Rocket 2300 III Touring	2300	2008	2009	522986
Rocket 2300 III Touring	2300	2008	2009	522985
Rocket 2300 III Touring ABS	2300	2010	2017	522986
Rocket 2300 III Touring ABS	2300	2010	2017	522985
VESPA				
Cosa 125 starter électrique	125	1987	1990	523021
Cosa 125 FL starter électrique	125	1991	1995	523021
Cosa 125 FL kick starter	125	1991	1995	523021
Cosa 125 kick starter	125	1987	1990	523021
Primavera 125	125	1967	1983	523047
Primavera 125 i AIR 4T	125	2013	2016	523039
Primavera ABS 125 i IGET AIR 4T	125	2016	2020	523039
Sprint ABS 125 i IGET AIR 4T	125	2016	2020	523039
Primavera 125 i AIR 4T	125	2013	2016	523040
Primavera ABS 125 i IGET AIR 4T	125	2016	2020	523040
Sprint ABS 125 i IGET AIR 4T	125	2016	2020	523040
GTS Super 125 i H2O 4T	125	2009	2016	523025
GTS Super ABS 125 i H2O 4T	125	2014	2016	523025
LX 125 i AIR 4T 2V	125	2009	2012	523033
LX Touring 125 i AIR 4T 2V	125	2010	2011	523033
S 125 i AIR 4T 2V	125	2009	2012	523033

Modèle	Cylindre	Année début	Année fin	Réf.
LT 125 i AIR 4T 3V	125	2013	2016	523027
LX 125 i AIR 4T 3V	125	2012	2014	523027
S 125 i AIR 4T 3V	125	2012	2017	523027
Primavera 125 i AIR 4T 3V	125	2013	2016	523041
Primavera ABS 125 i IGET AIR 4T	125	2016	2020	523041
Sprint ABS 125 i IGET AIR 4T	125	2016	2020	523041
GTS Super 125 i H2O 4T	125	2009	2016	523026
LX 125 AIR 4T	125	2006	2011	523031
LT 125 i AIR 4T 3V	125	2013	2016	523028
GTS Super ABS 125 i H2O 4T	125	2014	2016	523026
S 125 AIR 4T	125	2007	2008	523031
LX 125 i AIR 4T 3V	125	2012	2014	523028
S 125 i AIR 4T 3V	125	2012	2017	523028
ET 4 125	125	2000	2006	523022
LX 125 AIR 4T	125	2005	2009	523029
LX 125 AIR 4T	125	2006	2011	523029
S 125 AIR 4T	125	2007	2008	523029
Granturismo 125 L H2O 4T	125	2003	2005	523023
Granturismo 125 L H2O 4T	125	2006	2006	523023
GTS 125 H2O 4T	125	2007	2012	523023
LX 125 i AIR 4T 2V	125	2009	2012	523032
LX Touring 125 i AIR 4T 2V	125	2010	2011	523032
S 125 i AIR 4T 2V	125	2009	2012	523032
LX 125 AIR 4T	125	2006	2011	523030
S 125 AIR 4T	125	2007	2008	523030
Primavera 125 i AIR 4T 3V	125	2013	2016	523042
Primavera ABS 125 i IGET AIR 4T 3V	125	2016	2020	523042
Sprint ABS 125 i IGET AIR 4T	125	2016	2020	523042
Primavera 150 i AIR 4T	150	2013	2016	523039
Primavera ABS 150 i IGET AIR 4T	150	2016	2020	523039
Sprint ABS 150 i IGET AIR 4T	150	2016	2020	523039
Primavera 150 i AIR 4T	150	2013	2016	523040
Primavera ABS 150 i IGET AIR 4T	150	2016	2020	523040
Sprint ABS 150 i IGET AIR 4T	150	2016	2020	523040
LX 150 i AIR 4T 2V	150	2009	2013	523033
LX Touring 150 i AIR 4T 2V	150	2010	2012	523033
S 150 i AIR 4T 2V	150	2009	2013	523033
LT 150 i AIR 4T 3V	150	2013	2013	523027
LX 150 i AIR 4T 3V	150	2012	2014	523027
S 150 i AIR 4T 3V	150	2014	2017	523027
Primavera 150 i AIR 4T	150	2013	2016	523041
Primavera ABS 150 i IGET AIR 4T	150	2016	2016	523041

Modèle	Cylindre	Année début	Année fin	Réf.
Sprint ABS 150 i IGET AIR 4T	150	2016	2020	523041
LX 150 AIR 4T	150	2006	2013	523031
LT 150 i AIR 4T 3V	150	2013	2013	523028
S 150 AIR 4T	150	2007	2010	523031
LX 150 i AIR 4T 3V	150	2012	2014	523028
S 150 i AIR 4T 3V	150	2012	2014	523028
ET4 150	150	2000	2006	523022
LX 150 AIR 4T	150	2005	2006	523029
LX 150 AIR 4T	150	2006	2013	523029
S 150 AIR 4T	150	2007	2010	523029
LX 150 i AIR 4T 2V	150	2009	2013	523032
LX Touring 150 i AIR 4T 2V	150	2010	2012	523032
S 150 i AIR 4T 2V	150	2009	2013	523032
LX 150 AIR 4T	150	2006	2013	523030
S 150 AIR 4T	150	2007	2010	523030
Primavera 150 i AIR 4T	150	2013	2016	523042
Primavera ABS 150 i IGET AIR 4T	150	2016	2020	523042
Sprint ABS 150 i IGET AIR 4T	150	2016	2020	523042
Cosa 200 CLX starter électrique	200	1988	1990	523021
Cosa 200 FL ABS starter électrique	200	1993	1997	523021
Cosa 200 FL starter électrique	200	1991	1994	523021
Granturismo 200 L H2O 4T	200	2003	2008	523023
GTS 250 i H2O 4T	250	2005	2016	523026
GTS ABS 250 i H2O 4T	250	2005	2009	523026
GTS 250 i H2O 4T	250	2005	2013	523024
GTS ABS 250 i H2O 4T	250	2005	2009	523024
GTS 250 i H2O 4T	250	2005	2016	523025
GTS ABS 250 i H2O 4T	250	2005	2009	523025
GTS 300 i H2O 4T	300	2012	2013	523026
GTS 300 i H2O 4T	300	2012	2013	523025
GTS ABS 300 i H2O 4T	300	2014	2018	523025
GTS Super 300 i H2O 4T	300	2008	2016	523025
GTS Super ABS 300 i H2O 4T	300	2014	2016	523025
GTS Super ABS 300 i HPE H2O 4T	300	2018	2020	523025
GTS Super ABS 300 i HPE H2O 4T	300	2020	2020	523025
GTS Touring 300 i H2O 4T	300	2011	2012	523025
GTS ABS 300 i H2O 4T	300	2014	2018	523026
GTS Super 300 i H2O 4T	300	2008	2016	523026
GTS Super ABS 300 i H2O 4T	300	2014	2016	523026
GTS Super ABS 300 i HPE H2O 4T	300	2018	2020	523026
GTS Touring 300 i H2O 4T	300	2011	2012	523026

Modèle	Cylindre	Année début	Année fin	Réf.
YAMAHA				
YP 125 R Majesty	125	1998	2000	523195
YP 125 R(D) Majesty	125	2001	2002	523195
YS 125	125	2017	2017	523198
YS 125	125	2017	2017	523197
BWS 125	125	2009	2014	523052
YBR 125 ED	125	2010	2016	523191
YBR 125 SPD Custom	125	2008	2016	523191
RS 125 (Drum)	125	1975	1975	523100
RS 125 DX (Disc)	125	1976	1976	523100
RS 125 DX (Disc)	125	1977	1981	523100
DT 125 LC	125	1982	1984	523059
DT 125	125	1978	1979	523058
YBR 125 Fuel Injection	125	2007	2009	523192
YBR 125	125	0	0	523189
YBR 125 Custom	125	2008	2009	523192
SR 125	125	1997	2002	523102
YZ 125	125	1996	2011	523199
TZR 125	125	1987	1992	523119
YZF-R 125	125	2008	2014	523206
YZF-R 125 Anniversaire	125	2012	2013	523206
Majesty 125 H2O 4T	125	2003	2006	522710
Majesty II 125 H2O 4T	125	2007	2009	522710
DT 125 R	125	1990	1996	523061
DT 125 RE	125	2005	2006	523061
DT 125 X	125	2006	2006	523061
XVS 125	125	2000	2004	523175
YBR 125 ED	125	2010	2016	523190
YBR 125 SPD Custom	125	2008	2016	523190
XT 125 R	125	2005	2012	523150
XT 125 X	125	2005	2012	523150
DT 125 R	125	1988	1988	523060
SR 125	125	1992	1996	523101
XVS 125	125	2000	2004	523176
RD 125	125	0	0	523090
YP 125 X-MAX	125	2012	2012	523196
YP 125 R X-MAX	125	2006	2016	523196
YP 125 R X-MAX Sport	125	2012	2012	523196
YP 125 RA (ABS) X-MAX	125	2012	2017	523196
N-MAX 125	125	2015	2015	523088
N-MAX 125 ABS	125	2017	2019	523088
WR 125 R	125	2009	2017	523123
WR 125 X	125	2009	2017	523123
TW 125	125	1998	2001	523117
Crypton-X135	135	0	0	523056

Modèle	Cylindre	Année début	Année fin	Réf.
N-MAX 150 ABS	150	2017	2018	523088
DT 175	175	1978	1979	523058
MX 175	175	1979	1981	523058
Majesty 180 H2O 4T	180	2003	2006	522710
RD 200	200	0	0	523090
XT 225 Serow	225	1989	1994	523151
YBR 250	250	2007	2013	523193
XS 250	250	1977	1980	523141
YZ 250	250	1996	2011	523200
RD 250	250	1976	1979	523092
WR 250 F	250	2005	2006	523124
YZ 250 F 4T	250	2004	2005	523124
RD 250	250	1973	1975	523091
DT 250 MX	250	1977	1982	523062
RD 250 LC	250	1980	1983	523093
YZ 250 F	250	2003	2006	523201
XT 250	250	1980	1990	523152
YP 250 R X-MAX	250	2005	2016	523196
YP 250 R X-MAX Sport	250	2012	2012	523196
YP 250 RA X-MAX	250	2012	2016	523196
X-Max 300	300	2017	2020	523139
YZF-R3	300	2015	2018	523211
RD 350	350	1973	1975	523091
RD 350 LC	350	1980	1983	523093
XT 350 H	350	1985	1990	523153
XT 350 N	350	1986	1995	523153
RD 350 LC YPVS	350	1983	1984	523094
XS 360	360	1977	1978	523142
XVS 400 Dragstar	400	1996	1999	523178
XVS 400 DRAG STAR	400	1996	1999	523177
XS 400	400	1980	1982	523141
XS 400 R	400	1982	1983	523143
SR 400	400	2015	2016	523103
RD 400	400	1976	1979	523092
XS 400 SE Special	400	1981	1983	523144
SR 400	400	2015	2016	523104
FZR 400	400	1988	1994	523077
YZ 450 F	450	2010	2013	523202
WR 450 F	450	2005	2006	523124
YZ 450 F	450	2004	2005	523124
RD 500 LC	500	1984	1985	523096
SR 500 G (ROUE BATON)	500	1979	1983	523105
SR 500 SP (ROUE RAYON)	500	1978	1983	523105
XT 500	500	1976	1989	523154
XT 500 S Edition	500	1988	1989	523154
RD 500 LC YPVS	500	1984	1985	523097

Modèle	Cylindre	Année début	Année fin	Réf.
SR 500 G (ROUE BATON)	500	1979	1983	523106
SR 500 SP (ROUE RAYON)	500	1978	1983	523106
SR 500 SP (frein à disque)	500	1986	1989	523108
SR 500 SP (frein à tambour)	500	1988	1990	523108
SR 500 SP (ROUE RAYON)	500	1984	1986	523108
SR 500 SP (frein à disque)	500	1986	1989	523107
SR 500 SP (frein à tambour)	500	1988	1990	523107
SR 500 SP (ROUE RAYON)	500	1984	1986	523107
SR 500 SP (frein à disque)	500	1991	1991	523110
SR 500 SP (frein à tambour)	500	1991	1999	523110
SR 500 SP (frein à disque)	500	1991	1991	523109
SR 500 SP (frein à tambour)	500	1991	1999	523109
XV 535 H Virago	535	1988	1994	523167
XV 535 N Virago	535	1988	1990	523167
XV 535 SH Virago	535	1994	1994	523167
XV 535 H Virago	535	1995	1997	523169
XV 535 H Virago DX	535	1998	2003	523169
XV 535 N Virago	535	1995	1997	523169
XV 535 N Virago DX	535	1998	2003	523169
XV 535 SH Virago	535	1995	1997	523169
XV 535 SN Virago	535	1995	1997	523169
XV 535 H Virago	535	1995	1997	523168
XV 535 H Virago DX	535	1998	2003	523168
XV 535 N Virago	535	1995	1997	523168
XV 535 N Virago DX	535	1998	2003	523168
XV 535 SH Virago	535	1995	1997	523168
XV 535 SN Virago	535	1995	1997	523168
XT 550	550	1982	1983	523156
XJ 550	550	1981	1984	523125
XT 550	550	1982	1983	523155
XT 550	550	1982	1983	523157
FZ 6 N 600	600	2004	2008	523069
FZ6 Fazer 600 S	600	2004	2008	523073
FZ6 Fazer 600 S2	600	2007	2008	523073
XJ 600 NH	600	1996	2003	523128
XJ 600 NN	600	1996	2003	523128
FZR 600 H Genesis	600	1992	1993	523079
FZR 600 M Genesis	600	1992	1993	523079
FZR 600 N Genesis	600	1992	1993	523079
XJ 600 SN Diversion	600	1992	1996	523130
XJ 600 SH Diversion	600	1992	1995	523130
XJ 600 H	600	1984	1991	523127
XJ 600 N	600	1984	1991	523127
XT 600 Z Tenere	600	1983	1984	523156
XJ 600 SH Diversion	600	1998	2003	523128
YZF-R6 600	600	2006	2007	523214



Modèle	Cylindre	Année début	Année fin	Réf.
YZF-R6 600 S Edition	600	2006	2007	523214
YZF-R6 600 H	600	1999	2002	523216
YZF-R6 600 N	600	1999	2002	523216
XJ 600 SH Diversion	600	1998	2003	523129
FZS 600 H Fazer	600	2002	2003	523084
FZS 600 N Fazer	600	2002	2003	523084
YZF-R6 600	600	2003	2005	523213
YZF-R6 600 H	600	1999	2002	523215
FZR 600 RH Genesis	600	1994	1995	523080
YZF-R6 600 N	600	1999	2002	523215
FZR 600 RM Genesis	600	1994	1995	523080
FZR 600 RN Genesis	600	1994	1995	523080
YZF 600 RH Thunder Cat	600	1996	2002	523080
YZF 600 RN Thunder Cat	600	1996	2002	523080
FZS 600 H Fazer	600	1998	2001	523083
FZS 600 N Fazer	600	1998	2001	523083
FZS 600 SH Fazer	600	2000	2001	523083
FZS 600 SN Fazer	600	2000	2001	523083
YZF-R6 600	600	2003	2005	523212
XT 600 Z Tenere	600	1983	1984	523155
TT 600 S	600	1993	1997	523116
XT 600 H	600	1987	1990	523116
XT 600 N	600	1987	1990	523116
XT 600 Z Tenere	600	1986	1991	523116
XT 600 EH	600	1990	1994	523159
XT 600 EN	600	1990	1994	523159
XT 600 KH	600	1991	1995	523159
XT 600 KN	600	1991	1995	523159
XJ 600 Diversion	600	1996	2002	523126
FZ6 600 N	600	2004	2007	523072
FZ6 600 NA ABS	600	2007	2008	523072
FZ6 600 NS	600	2005	2006	523072
FZ6 S2 600 NAHG ABS	600	2007	2010	523072
FZ6 S2 600 NHG	600	2007	2010	523072
FZR 600 H Genesis	600	1989	1993	523078
FZR 600 M Genesis	600	1989	1993	523078
FZR 600 N Genesis	600	1989	1993	523078
XT 600 EH	600	1990	1994	523158
XT 600 KH	600	1991	1995	523158
XT 600 EN	600	1990	1994	523158
XT 600 KN	600	1991	1995	523158
FZ 6 Fazer 600 S	600	2004	2008	523068
FZ 6 Fazer 600 S2	600	2008	2010	523068
XVS 650 DRAG STAR	650	1997	1997	523178
XVS 650 DRAG STAR	650	1997	1997	523177
XJ 650 RJ	650	1982	1982	523131

Modèle	Cylindre	Année début	Année fin	Réf.
TX 650	650	1974	1974	523118
XVS 650 AH Drag Star Classic	650	1998	2007	523180
XVS 650 AN Drag Star Classic	650	1998	2007	523180
XVS 650 H Drag Star	650	1998	2003	523180
XVS 650 N Drag Star	650	1998	2003	523180
V Star 650 Classic	650	2007	2010	523122
V Star 650 Silverado	650	2007	2010	523122
XS 650 SE Special	650	1981	1983	523147
XS 650 SE US Custom	650	1980	1980	523147
XVS 650	650	2002	2016	523179
XS 650	650	1974	1975	523118
XS 650	650	1975	1975	523145
TX 650	650	1974	1974	523145
XVS 650 Custom	650	2006	2015	523181
XVS 650 Midnight Custom	650	2005	2010	523181
XS 650	650	1976	1981	523146
XT 660 R	660	2004	2016	523161
XT 660 X	660	2004	2016	523161
XT 660 Z Tenere	660	2008	2014	523161
XT 660 ZA Tenere ABS	660	2011	2014	523161
XTZ 660 H Tenere	660	1991	1998	523159
XTZ 660 N Tenere	660	1992	1995	523159
XT 660 R	660	2004	2016	523160
XT 660 X	660	2004	2016	523160
XT 660 Z Tenere	660	2008	2014	523160
XT 660 ZA Tenere ABS	660	2011	2014	523160
XTZ 660 H Tenere	660	1991	1998	523158
XTZ 660 N Tenere	660	1992	1995	523158
YFM 660 R	660	2001	2005	523194
MT-07	700	2014	2020	523086
FZ 07	700	2015	2017	523086
YZF 750 R	750	1993	1994	523205
FZ 750	750	1985	1986	523070
FZ 750 Genesis	750	1987	1987	523070
XJ 750 Seca	750	1982	1984	523132
XV 750 SE Special	750	1981	1984	523170
XV 750 Virago (ROUE BATON)	750	1992	1994	523171
XV 750 Virago (ROUE RAYON)	750	1994	1997	523171
XS 750 E	750	1978	1979	523149
XTZ 750 H Super Tenere	750	1989	1997	523162
XTZ 750 N Super Tenere	750	1990	1993	523162
XS 750	750	1977	1977	523148
XS 750	750	1979	1979	523148
XS 750 SE	750	1980	1980	523148
XV 750 Virago (ROUE BATON)	750	1992	1994	523172
XV 750 Virago (ROUE RAYON)	750	1994	1997	523172

Modèle	Cylindre	Année début	Année fin	Réf.
TDM 850	850	1999	2001	523112
TDM 850	850	1996	1998	523111
XS 850	850	1980	1982	523149
TRX 850	850	1996	1999	523115
TDM 850 H	850	1991	1996	523113
TDM 850 N	850	1991	1993	523113
XS 850 SE	850	1980	1982	523148
XJ 900	900	1983	1986	523133
XJ 900 F	900	1985	1994	523133
XJ 900 S Diversion	900	1995	2003	523135
TDM 900	900	2002	2011	523114
TDM 900 A ABS	900	2005	2013	523114
MT-09	900	2018	2020	523087
FZ-09	900	2014	2017	523087
XSR 900	900	2016	2020	523087
XJ 900	900	1995	0	523134
XVS 950 V Star	950	2009	2016	523185
XVS 950 CT V Star Tourer	950	2009	2017	523185
XVS 950 V Star	950	2009	2016	523184
XVS 950 CT V Star Tourer	950	2009	2017	523184
XVS 950 Bolt	950	2014	2020	523182
XVS 950 Bolt R-Spec	950	2014	2021	523182
XVS 950 Bolt	950	2014	2020	523183
XVS 950 Bolt R-Spec	950	2014	2021	523183
FZR 1000 Genesis Exup	1000	1991	1995	523076
XV 1000 Virago	1000	1986	1988	523164
FZR 1000 Genesis Exup	1000	1989	1990	523075
YZF-R1 1000	1000	2004	2006	523209
YZF-R1 1000 SP	1000	2006	2006	523209
YZF-R1 1000	1000	1998	2001	523207
FZS 1000 Fazer	1000	2001	2005	523081
FZS 1000 S Fazer	1000	2003	2005	523081
YZF-R1 1000	1000	2002	2003	523208
FZ1 1000 N	1000	2006	2015	523071
FZ1 1000 NA ABS	1000	2008	2015	523071
FZ1 1000 S Fazer	1000	2006	2015	523071
FZ1 1000 S GT Fazer	1000	2007	2007	523071
FZ1 1000 SA Fazer ABS	1000	2007	2015	523071
FZ1 1000 SA GT Fazer ABS	1000	2007	2015	523071
FZS 1000 Fazer	1000	2001	2005	523082
FZS 1000 S Fazer	1000	2003	2005	523082
YZF 1000 R Thunder Ace	1000	1996	2002	523204
FZR 1000 Genesis Exup	1000	1989	1990	523074
XV 1000 TRI	1000	1981	1984	523163
YZF-R1 1000	1000	2007	2008	523210
FJ 1100	1100	1984	1985	523065

Modèle	Cylindre	Année début	Année fin	Réf.
XVS 1100 A Drag Star Classic	1100	2002	2007	523173
XVS 1100 Drag Star	1100	2000	2002	523174
XVS 1100 A Drag Star Classic	1100	2000	2007	523174
XV 1100 SP Virago (ROUE RAYON)	1100	1994	1999	523171
XV 1100 Virago (ROUE BATON)	1100	1989	1993	523171
XS 1100	1100	1980	1983	523140
FJ 1100	1100	1984	1985	523066
XV 1100 SP Virago (ROUE RAYON)	1100	1994	1999	523172
XV 1100 Virago (ROUE BATON)	1100	1989	1993	523172
XVZ 1200 TD Venture Royale	1200	1984	1985	523187
FJ 1200	1200	1991	1993	523067
FJ 1200	1200	1986	1990	523065
V MAX 12 V-MAX (JP)	1200	1990	1999	523120
V MAX 12 V-MAX (JP)	1200	1990	1999	523121
XJR 1200	1200	1995	1998	523136
XJR 1200 SP	1200	1997	1998	523136
XVZ 1200 TD Venture Royale	1200	1984	1985	523186
FJ 1200	1200	1986	1990	523066
XVZ 1300 ROYAL STAR	1300	1998	2000	523188
XVZ 1300 LT Royal Star Tour Deluxe	1300	1998	2001	523188
XVZ 1300 AT Royal Star Tour Classic	1300	1996	2000	523188
XVZ 1300 A Royal Star	1300	1996	1997	523188
XVZ 1300 AL Royal Star Boulevard	1300	1999	2001	523188
XJR 1300	1300	1999	2001	523136
XJR 1300 SP	1300	1999	2001	523136
XJR 1300	1300	2007	2011	523138
XJR 1300	1300	2002	2006	523137
XV 1700 Road Star Warrior	1700	2002	2003	523166
XV 1700 Road Star Warrior	1700	2002	2003	523165
SRX 600	600	1986	1989	523049
SRX 600	600	1986	1989	523050
FZX 700	700	1986	1987	523048



/ DONUTS REVETEMENT / POIGNEE

Désignation	Réf.
BLEU (PR)	500450
GRIS (PR)	500448
NOIR (PR)	500447
ORANGE (PR)	500451
ROUGE (PR)	500449
VERT (PR)	500452



/ ARIES SUPERSOFT / DEBOUCHE POUR EMBOUT

Désignation	Réf.
GRIS CLAIR (PR) - 125MM	521263
NOIR (PR) - 125MM	521265
NOIR (PR) - 125MM	521264



/ ARIRAM / DEBOUCHE POUR EMBOUT DE GUIDON

Désignation	Réf.
BLEU / BLANC (PR) - 120MM	521266
GRIS / NOIR (PR) - 120MM	521267
NOIR / BLEU (PR) - 120MM	521269
NOIR / GRIS (PR) - 120MM	521270
NOIR / JAUNE (PR) - 120MM	521271
NOIR / ORANGE (PR) - 120MM	521272
NOIR / ROUGE (PR) - 120MM	521268
NOIR / VERT (PR) - 120MM	521273
ROUGE / NOIR (PR) - 120MM	521274



/ ESTORIL

Désignation	Réf.
NOIR / BLEU (PR) - 120MM	521275
NOIR / GRIS (PR) - 120MM	521276
NOIR / ROUGE (PR) - 120MM	521277



/ FUSION

Désignation	Réf.
NOIR SUPERSOFT (PR) - 125MM	521384





/ HERITAGE VINTAGE

Désignation	Réf.
BORDEAUX (PR) - 130MM	521278
MARRON (PR) - 130MM	521279
NOIR (PR) - 130MM	521280



/ STANDARD

Désignation	Réf.
NOIR (PR) - 120MM	521281



/ TRIAL SUPERSOFT

Désignation	Réf.
NOIR (PR) - 120MM	521282



/ UNITY HALF WAFFLE

Désignation	Réf.
BLEU (PR) - 115MM	521283
JAUNE FLUO (PR) - 115MM	521284
NOIR (PR) - 115MM	521285
ORANGE (PR) - 115MM	521286
ROUGE (PR) - 115MM	521287
VERT (PR) - 115MM	521288



/ UNITY HALF SLIMLINE

Désignation	Réf.
GRIS CLAIR (PR) - 115MM	521289
GRIS FONCE (PR) - 115MM	521290
NOIR (PR) - 115MM	521291



/ VULCAN

Désignation	Réf.
BLANC / NOIR (PR) - 115MM	521292
BLEU / BLANC (PR) - 115MM	521293
GRIS / ORANGE (PR) - 115MM	521294
NOIR / GRIS (PR) - 115MM	521295
NOIR / JAUNE (PR) - 115MM	521296
NOIR / ORANGE (PR) - 115MM	521297
NOIR / ROUGE (PR) - 115MM	521298
NOIR / VERT (PR) - 115MM	521299





/ QUAD / ATV



Désignation	Réf.
NOIR (PR) - 125MM	521300



/ CHESTERFIELD



Désignation	Réf.
MARRON (PR) - 124MM	506781
NOIR (PR) - 124MM	506780



/ HANZO



Désignation	Réf.
NOIR / ARGENT (PR)	506786
NOIR / NOIR (PR)	506784
NOIR / ROUGE (PR)	506785



/ HATTORI



Désignation	Réf.
MARRON (PR) - 124MM	506783
NOIR (PR) - 124MM	506782



/ LEXHAM

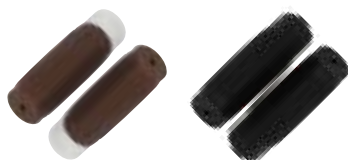

Désignation	Réf.
MARRON (PR) - 124MM	506775
NOIR (PR) - 124MM	506772



/ POLAR

Désignation	Réf.
JAUNE FLUO / GRIS (PR)	496886
NOIR / BLANC (PR)	468271
NOIR / GRIS (PR)	468272
NOIR / ORANGE (PR)	468273
NOIR / ROUGE (PR)	468274
BLANC / NOIR (PR)	468276



/ HARROW



Désignation	Réf.
NOIR (PR) - 120MM	511991



/ HALBORN



Désignation	Réf.
MARRON (PR)	515605
NOIR (PR)	515604



/ NOTTING



Désignation	Réf.
NOIR (PR) - 125MM	511564



/ SOHO

Désignation	Réf.
BLACKWAY SOHO NOIR / BLANC (PR) - 125MM	511562
BLACKWAY SOHO NOIR / NOIR (PR) - 125MM	511561
BLACKWAY SOHO NOIR / ROUGE (PR) - 125MM	511563



/ STRATFORD

Désignation	Réf.
BLACKWAY STRATFORD MARRON (PR) - 124MM	506777
BLACKWAY STRATFORD NOIR (PR) - 124MM	506776



/ WOODFORD

Désignation	Réf.
BLACKWAY WOODFORD MARRON (PR) - 124MM	506779
BLACKWAY WOODFORD NOIR (PR) - 124MM	506778



/ A260+ CROSS/ENDURO

Désignation	Réf.
BRONZE (PR) 120MM	515908



/ A020 CROSS DOUBLE DENSITE

Désignation	Réf.
BLEU / BLANC (PR) 118MM	490376
GRIS / ORANGE (PR) 118MM	519584
NOIR / GRIS (PR) 118MM	490374
NOIR / JAUNE (PR) 118MM	490373
NOIR / ORANGE (PR) 118MM	490372
NOIR / ROUGE (PR) 118MM	490371
NOIR / VERT (PR) 118MM	490375



/ A020 CROSS/ENDURO

Désignation	Réf.
BLEU / BLANC (PR) 120MM	519583
BLANC / NOIR (PR) 120MM	519581
NOIR / GRIS (PR) 120MM	482910
NOIR / JAUNE FLUO (PR) 120MM	519582
NOIR / ORANGE (PR) 120MM	482909
NOIR / ROUGE (PR) 120MM	482908
NOIR / VERT (PR) 120MM	482907





/ A350 TURISMO

Désignation	Réf.
BLEU / NOIR (PR)	519587
GRIS / ANTHRACITE (PR)	519585
NOIR / BLEU (PR)	496023
NOIR / GRIS (PR)	496025
NOIR / MARRON (PR)	496022
NOIR / ORANGE (PR)	496026
NOIR / ROUGE (PR)	496021
NOIR / VERT (PR)	496024
ROUGE / NOIR (PR)	519586
VERT / NOIR (PR)	519588



/ A360

Désignation	Réf.
BLEU / BLANC (PR)	499196
BLEU / JAUNE (PR)	519375
GRIS / ORANGE (PR)	519580
NOIR / GRIS (PR)	499195
NOIR / JAUNE (PR)	499194
NOIR / ORANGE (PR)	499193
NOIR / ROUGE (PR)	499191
NOIR / VERT (PR)	499192
ROUGE / BLANC (PR)	519374



/ A450

Désignation	Réf.
BLEU / BLANC (PR)	519081
BLEU / NOIR (PR)	519085
BLEU / ROUGE (PR)	519074
GRIS ANTHRACITE / NOIR (PR)	519077
GRIS / JAUNE FLUO (PR)	519076
NOIR / BLANC (PR)	519073
NOIR / BLEU (PR)	519084
NOIR / GRIS (PR)	519082
NOIR / JAUNE (PR)	519080
NOIR / ORANGE (PR)	519083
NOIR / ROUGE (PR)	519079
NOIR / VERT (PR)	519078
ROSE / NOIR (PR)	519088
ROUGE / BLANC (PR)	519075
ROUGE / NOIR (PR)	519086
VERT / NOIR (PR)	519087



MOTEUR

CYCLE

PNEUMATIQUE

ATELIER

ACCESSOIRES

ÉLECTRICITÉ

FILTRATION

FREINAGE

TRANSMISSION



/ D-LOCK 4 TEMPS

Désignation	Réf.
NOIR (PR) 116MM	520976



/

Désignation	Réf.
JAUNE FLUO (PR) 118MM	510058



/

Désignation	Réf.
MARRON (PR) 118MM	512923



/ QUAD / ATV

Désignation	Réf.
NOIR (PR) 120MM	501201



/ TYPE ORIGINE DERBI SENDA

Désignation	Réf.
NOIR (PR) 118MM	505612



/ TYPE ORIGINE HONDA

Désignation	Réf.
NOIR (PR) 120MM	493946



/ TYPE ORIGINE SUZUKI

Désignation	Réf.
NOIR (PR) 120MM	493945



/ TYPE ORIGINE YAMAHA

Désignation	Réf.
NOIR (PR) 120MM	493944



/ VINTAGE CAFE RACER

Désignation	Réf.
MARRON (PR) 120MM	500621



/ VINTAGE CROSS

Désignation	Réf.
MARRON (PR) 120MM	493948



/ VINTAGE

Désignation	Réf.
MARRON (PR) 120MM	490364



/ STRADALE

Désignation	Réf.
NOIR (PR)	508099
NOIR (PR)	508098

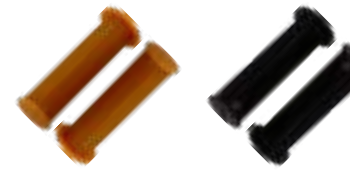

/ VINTAGE DAYTONA

Désignation	Réf.
MARRON (PR) 130MM	519589
NOIR (PR) 130MM	519590



/ 761 - SIMPLE DENSITE

Désignation	Réf.
GAUCHE ADAPT. 50 FIFTY / 125 SCRAMBLER / SEVENTY	511039

Désignation	Réf.
NOIR (PR) 122MM	440917



/ 732 - DOUBLE DENSITE

Désignation	Réf.
BLANC / NOIR (PR) 122MM	484527
BLEU / NOIR (PR) 122MM	484531
NOIR / BLANC (PR) 122MM	484530
NOIR / ORANGE (PR) 122MM	490302
NOIR / ROSE FUSHIA (PR) 122MM	489530
ROUGE / NOIR (PR) 122MM	484528
VERT / NOIR (PR) 122MM	484529



/ 788 - TRIPLE DENSITE

Désignation	Réf.
BLANC / NOIR (PR) 115MM	490097
BLEU / BLANC (PR) 115MM	490094
BLEU / JAUNE FLUO / BLANC (PR) 115MM	500877
BLEU / JAUNE FLUO / NOIR (PR) 115MM	500876
GRIS / JAUNE FLUO / NOIR (PR) 115MM	499248
GRIS / ROUGE / NOIR (PR) 115MM	503946
JAUNE FLUO / NOIR / BLANC (PR)	499249
NOIR / BLANC (PR) 115MM	490096
ORANGE FLUO / BLEU (PR) 115MM	500878
ORANGE FLUO / BLEU / BLANC (PR) 115MM	499253
ORANGE FLUO / BLEU / NOIR (PR) 115MM	499252
ORANGE FLUO / JAUNE FLUO / NOIR (PR) 115MM	499251
ORANGE / BLANC (PR) 115MM	490093
ROUGE / BLANC (PR) 115MM	490095
ROUGE / JAUNE FLUO / NOIR (PR) 115MM	499250
VERT / BLANC (PR) 115MM	490092



/ 789

Désignation	Réf.
NOIR (PR) 115MM	166857





/ 791 - DOUBLE DENSITE

Désignation	Réf.
BLANC / FUSHIA (PR) 115MM	499254
BLANC / JAUNE FLUO (PR) 115MM	499258
BLANC / ORANGE FLUO (PR) 115MM	499256
BLANC / VERT FLUO (PR) 115MM	499255
JAUNE FLUO / BLEU (PR) 115MM	499257
ORANGE FLUO / BLEU (PR) 115MM	499259
ORANGE FLUO / NOIR (PR) 115MM	499260



/ 794 - DOUBLE DENSITE

Désignation	Réf.
BLANC / FUSHIA (PR) 115MM	499254
BLANC / JAUNE FLUO (PR) 115MM	499258
BLANC / ORANGE FLUO (PR) 115MM	499256
BLANC / VERT FLUO (PR) 115MM	499255
JAUNE FLUO / BLEU (PR) 115MM	499257
ORANGE FLUO / BLEU (PR) 115MM	499259
ORANGE FLUO / NOIR (PR) 115MM	499260



/ 801 - DOUBLE DENSITE

Désignation	Réf.
BLANC / NOIR (PR) 115MM	484523
GRIS / BLEU (PR) 115MM	484524
JAUNE FLUO / BLEU (PR) 115MM	507552
NOIR / BLEU (PR) 115MM	507547
NOIR / BLEU LIGHT (PR) 115MM	507548
NOIR / GRIS (PR) 115MM	507549
NOIR / JAUNE FLUO (PR) 115MM	492059
NOIR / ORANGE FLUO (PR) 115MM	492060
NOIR / ROSE (PR) 115MM	507551
NOIR / ROUGE (PR) 115MM	507550
NOIR / VERT FLUO (PR) 115MM	492058



/ ROAD 728 - BAGUE ALU

Désignation	Réf.
NOIR / BLEU (PR) 122MM	482178
NOIR / OR (PR) 122MM	482177
NOIR / ROUGE (PR) 122MM	482179



MOTEUR

CYCLE

PNEUMATIQUE

ATELIER

ACCESSOIRES

ÉLECTRICITÉ

FILTRATION

FREINAGE

TRANSMISSION



TUN'R
/ ROADER

Désignation	Réf.
BLANC / NOIR (PR)	482897
NOIR / BLANC (PR)	482892
NOIR / BLEU (PR)	482891
NOIR / GRIS (PR)	482895
NOIR / ORANGE (PR)	482893
NOIR / ROUGE (PR)	482896



YASUNI
/ PRO RACE

Désignation	Réf.
GRIS (PR)	510018
JAUNE (PR)	510020
NOIR (PR)	510016
ROUGE (PR)	510019



DOPPLER
/ REVETEMENT/POIGNEE GRIP RADICAL

Désignation	Réf.
BLANC/NOIR (PR)	487279
NOIR/BLANC (PR)	487280
NOIR/ROUGE(PR)	487283
NOIR/BLEU(PR)	487284

TUN'R
/ CROSS BI COULEUR

Désignation	Réf.
GRIS / ORANGE (PR)	494237
GRIS / VERT (PR)	494235

TUN'R
/ SKULL

Désignation	Réf.
ORANGE / BLANC (PR)	493994

TUN'R
/ MOTOCROSS

Désignation	Réf.
ORANGE FLUO (PR)	487287



DOPPLER
/ REVETEMENT/POIGNEE GRIP RADICAL 3D

Désignation	Réf.
BLANC/NOIR (PR)	517390
NOIR/BLANC (PR)	517391
BLEU/BLANC/ROUGE (PR)	517392
GRIS/NOIR/JAUNE FLUO (PR)	517393
ROUGE/BLANC/NOIR (PR)	517394
ROSE/BLANC/NOIR (PR)	517395
NOIR/BLANC/BLEU (PR)	517396
NOIR (PR)	517518
BLEU/BLANC/JAUNE FLUO (PR)	517947
VIOLET/NOIR (PR)	532453

MOTEUR

CYCLE

PNEUMATIQUE

ATELIER

ACCESSOIRES

ÉLECTRICITÉ

FILTRATION

FREINAGE

TRANSMISSION



486122

RETRO MAXI SCOOTER DROIT TEKNIX ADAPT. 125 HONDA SH 09->/ SFX50/X8R HOMOLOGUE CE



485701

RETRO MAXI SCOOTER DROIT VICMA ADAPT. 125 HONDA PCX HOMOLOGUE CE

485702

RETRO MAXI SCOOTER GAUCHE VICMA ADAPT. 125 HONDA PCX HOMOLOGUE CE



501180

RETRO MAXI SCOOTER DROIT TEKNIX ADAPT. 125/250/300/400 PIAGGIO MP3 HOMOLOGUE CE

501181

RETRO MAXI SCOOTER GAUCHE TEKNIX ADAPT. 125 / 250 / 300 / 400 PIAGGIO MP3 HOMOLOGUE CE



484957

RETRO MAXI SCOOTER DROIT TEKNIX ADAPT. XMAX/SKYCRUISER 2009-> HOMOLOGUE CE



486098

RETRO MAXI SCOOTER GAUCHE TEKNIX ADAPT. 500 YAMAHA TMAX 2008->2011 HOMOLOGUE CE



486103

RETRO MAXI SCOOTER DROIT TEKNIX ADAPT. 530 YAMAHA TMAX 2012-> HOMOLOGUE CE

486102

RETRO MAXI SCOOTER GAUCHE TEKNIX ADAPT. 530 YAMAHA TMAX 2012-> HOMOLOGUE CE



477509

RETRO MAXI SCOOTER DROIT TEKNIX ADAPT. YAMAHA MAJESTY / MBK SKYLINER HOMOLOGUE CE

477508

RETRO MAXI SCOOTER GAUCHE TEKNIX ADAPT. YAMAHA MAJESTY/MBK SKYLINER HOMOLOGUE CE



477507

RETRO MAXI SCOOTER DROIT TEKNIX ADAPT. YAMAHA XMAX / MBK SKYCRUISER 07->08 HOMOLOGUE CE

477506

RETRO MAXI SCOOTER GAUCHE TEKNIX ADAPT. YAMAHA XMAX/MBK SKYCRUISER 07->08 HOMOLOGUE CE



484956

RETRO MAXI SCOOTER GAUCHE TEKNIX ADAPT. YAMAHA XMAX/ MBK SKYCRUISER 2009-> HOMOLOGUE CE



482363

RETRO SCOOTER GAUCHE TEKNIX ADAPT. DINK 50/125 -SUPER DINK/DOWNTOWN -HOMOLOGUE



482366

RETRO SCOOTER DROIT TEKNIX ADAPT. LIBERTY 50/125 - LX 50/125 CHROME - HOMOLOGUE

482365

RETRO SCOOTER GAUCHE TEKNIX ADAPT. LIBERTY 50 / 125 - LX 50 / 125 CHROME - HOMOLOGUE CE



482362

RETRO SCOOTER/MAXI SCOOTER GAUCHE TEKNIX ADAPT. 50/125 SYM FIDDLE II HOMOLOGUE CE



467913

RETRO MAXI SCOOTER DROIT
VICMA ADAPT. 125/200 PIAGGIO
X8/250 X8i.e. HOMOLOGUE CE



467912

RETRO MAXI SCOOTER
GAUCHE VICMA ADAPT. 125 /
200 PIAGGIO X8 / 250 X8i.e.
HOMOLOGUE CE



440811

RETRO MAXI SCOOTER DROIT
VICMA ADAPT. 125/180/250/500
PIAGGIO X9 HOMOLOGUE CE



440810

RETRO MAXI SCOOTER
GAUCHE VICMA ADAPT. 125
/ 180 / 250 / 500 PIAGGIO X9
HOMOLOGUE CE



485703

RETRO SCOOTER/MAXI
SCOOTER DROIT VICMA ADAPT.
50/125 PEUGEOT TWEET/
BELVILLE HOMOLOGUE CE



485704

RETRO SCOOTER / MAXI
SCOOTER GAUCHE VICMA
ADAPT. 50 / 125 PEUGEOT
TWEET / BELVILLE
HOMOLOGUE CE



484857

RETRO MAXI SCOOTER DROIT
VICMA ADAPT. 125/250/400
PIAGGIO MP3 ->2011
HOMOLOGUE



480433

RETRO MAXI SCOOTER
GAUCHE VICMA ADAPT. 125 /
250 / 400 PIAGGIO MP3 ->2011
HOMOLOGUE



485119

RETRO MECABOITE/MOTO
DROIT VICMA ADAPT. GPR
2004->2009 50/125/SC 125
-HOMOLOGUE CE-



485120

RETRO MECABOITE / MOTO
GAUCHE VICMA ADAPT. GPR
2004->2009 50 / 125 / SC 125
-HOMOLOGUE CE-



455270

RETRO SCOOTER/MAXI
SCOOTER DROIT VICMA ADAPT.
50/100/125/150 PEUGEOT
ELYSTAR HOMOLOGUE CE



455290

RETRO SCOOTER / MAXI
SCOOTER GAUCHE VICMA
ADAPT. 50 / 100 / 125 /
150 PEUGEOT ELYSTAR
HOMOLOGUE CE



486996

RETRO MECABOITE/MOTO
DROIT VICMA ADAPT. RS4 50/125/
RS 125 06->10 -HOMOLOGUE CE-



486997

RETRO MECABOITE/MOTO
GAUCHE VICMA ADAPT. RS4 50/125/
RS 125 06->10 -HOMOLOGUE CE-

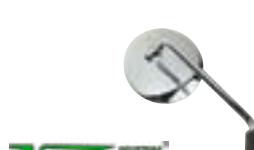

485705

RETRO SCOOTER/MAXI
SCOOTER DROIT VICMA ADAPT.
50/125 SYM FIDDLE II
HOMOLOGUE CE



485706

RETRO SCOOTER / MAXI
SCOOTER GAUCHE VICMA
ADAPT. 50 / 125 SYM FIDDLE II
HOMOLOGUE CE



495373

RETRO MECABOITE DROIT VICMA
ADAPT. XPS/XPS STREET EVO3/
DERBI GP1 -HOMOLOGUE CE-
M8 125



495372

RETRO MECABOITE GAUCHE
VICMA ADAPT. XPS / XPS
STREET EVO3 / DERBI GP1
-HOMOLOGUE CE- M8 125



208012

RETRO MECABOITE GAUCHE VICMA CHROME - DIA 8 -
HOMOLOGUE CE

MOTEUR

CYCLE

PNEUMATIQUE

ATELIER

ACCESSOIRES

ÉLECTRICITÉ

FILTRATION

FREINAGE

TRANSMISSION



485117

485118

RETRO MECABOITE/MOTO DROIT VICMA ADAPT. RIEJU RS3 50/125 -HOMOLOGUE CE-

RETRO MECABOITE / MOTO GAUCHE VICMA ADAPT. RIEJU RS3 50 / 125 -HOMOLOGUE CE



496329*

RETRO MECABOITE REPLIABLE/RABATTABLE VICMA UNIVERSEL REGLABLE EN HAUTEUR AVEC COLLIER CE



455262

RETRO MECABOITE/MOTO DROIT VICMA ADAPT. RS50/125/250 1997->2010 -HOMOLOGUE CE-



504394*

504393*

RETRO SCOOTER DROIT VICMA ADAPT. 50/100/125 FLY 2005 -> 2011/BOULEVARD - M8X125

RETRO SCOOTER GAUCHE VICMA ADAPT. 50 / 100 / 125 FLY 2005-> 2011 / BOULEVARD - M8X125



498595

RETRO MECABOITE GAUCHE VICMA UNIVERSEL RABATTABLE/ REPLIABLE - HOMOLOGUE CE



481224

481225

RETRO SCOOTER DROIT VICMA ADAPT. VESPA LX 50/125/ PIAGGIO LIBERTY 50/125 CHROME HOMOLOGUE CE

RETRO SCOOTER GAUCHE VICMA ADAPT. VESPA LX 50 / 125 / PIAGGIO LIBERTY 50 / 125 CHROME HOMOLOGUE



455267

455283

RETRO SCOOTER DROIT VICMA ADAPT. ELYSEO 50/125 - HOMOLOGUE CE

RETRO SCOOTER GAUCHE VICMA ADAPT. ELYSEO 50 / 125 HOMOLOGUE CE



717

RETRO UNIVERSEL VICMA A COLLIER ROND NOIR REVERSIBLE



455288

RETRO SCOOTER GAUCHE VICMA ADAPT. SQUAB/TREKKER M8/125-HOMOLOGUE CE



195245*

RETRO UNIVERSEL VICMA ROND D 8 CHROME A COLLIER REVERSIBLE



517336

RETRO MOTO ADAPT. YAMAHA 125 YBR 2005->/MT03 06->14/ XT660R/X/Z 04->17 -HOMOLOGUE (PR)



515576*

RETRO CYCLO REVERSIBLE VINTAGE RECTANGLE ACIER CHROME (110X67MM) - AVEC COLLIER DIA22.2MM



Sélection
CGN

517340

RETRO MOTO ADAPT. HONDA -HOMOLOGUE (PR)



Sélection
CGN

462617

RETRO UNIVERSEL MULTIPosition NOIR A COLLIER TIGE D8 AVEC ROTULES (PR) HOMOLOGUE CE



Sélection
CGN

502020*

RETRO UNIVERSEL NOIR COLLIER ROND REVERSIBLE



Sélection
CGN

493074*

RETRO UNIVERSEL REVERSIBLE ROND D 8 ACIER CHROME A COLLIER AJUSTABLE EN HAUTEUR



Sélection
CGN

497580*

RETRO UNIVERSEL REVERSIBLE ROND D10 ACIER CHROME A COLLIER AJUSTABLE EN HAUTEUR (PR)



Sélection
CGN

511706

RETRO UNIVERSEL/ENDURO PLASTIQUE NOIR (GAUCHE) - RABATTABLE/REPLIABLE - HOMOLOGUE CE



BLACKWAY
EQUIPEMENT MOTOR

511701

RETRO UNIVERSEL BLACKWAY ATOM ALUMINIUM NOIR (GAUCHE) - HOMOLOGUE CE



BLACKWAY
EQUIPEMENT MOTOR

517806

RETRO UNIVERSEL BLACKWAY BORE ABS NOIR (PR) - HOMOLOGUE CE



BLACKWAY
EQUIPEMENT MOTOR

517803

RETRO UNIVERSEL BLACKWAY GAMMA ALUMINIUM NOIR (PR) - HOMOLOGUE CE

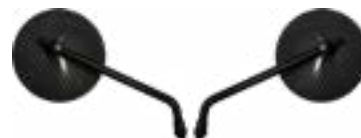

BLACKWAY
EQUIPEMENT MOTOR

518052

RETRO UNIVERSEL BLACKWAY ONDE ALUMINIUM CARBONE LOOK (PR) - HOMOLOGUE CE



BLACKWAY
EQUIPEMENT MOTOR

517805

RETRO UNIVERSEL BLACKWAY ONDE ALUMINIUM CHROME (PR) - HOMOLOGUE CE



BLACKWAY
EQUIPEMENT MOTOR

517804

RETRO UNIVERSEL BLACKWAY ONDE ALUMINIUM NOIR (PR) - HOMOLOGUE CE

MOTEUR

CYCLE

PNEUMATIQUE

ATELIER

ACCESSOIRES

ÉLECTRICITÉ

FILTRATION

FREINAGE

TRANSMISSION



511705

RETRO UNIVERSEL BLACKWAY NEUTRON ALUMINIUM NOIR (GAUCHE) - HOMOLOGUE CE



511709

RETRO UNIVERSEL BLACKWAY PLASMA ALUMINIUM NOIR (REVERSIBLE GAUCHE/DROIT) - HOMOLOGUE CE



511703

RETRO UNIVERSEL BLACKWAY SUPRA ALUMINIUM NOIR (GAUCHE) - HOMOLOGUE CE



511704*

RETRO UNIVERSEL BLACKWAY ARGON ALUMINIUM NOIR (GAUCHE)



512636*

RETRO UNIVERSEL BLACKWAY ELECTRON ALUMINIUM NOIR (DROIT)

511865*

RETRO UNIVERSEL BLACKWAY ELECTRON ALUMINIUM NOIR (GAUCHE)



511702*

RETRO UNIVERSEL BLACKWAY TOKAMAK ALUMINIUM NOIR (GAUCHE)



517257

RETRO UNIVERSEL BLACKWAY TRITIUM ABS NOIR - HOMOLOGUE CE (PR)



504222*

RETRO MOTO GAUCHE OEM RIEJU MRT/MRT PRO/ MARATHON(0/000.990.5003) CARBONE



497589*

RETRO UNIVERSEL TUN'R ECHO ALU CNC COURT NOIR (PR)



501220*

RETRO UNIVERSEL TUN'R ECHO ALU CNC LONG ARGENT (PR)



501219*

RETRO UNIVERSEL TUN'R ECHO ALU CNC LONG NOIR (PR)



504258*

RETRO UNIVERSEL TUN'R CAFE RACER D10 NOIR (PR)



479523*

RETRO UNIVERSEL BCD F1 PRO D 8 BLANC DROIT



479123*

RETRO UNIVERSEL BCD F1 PRO D 8 BLANC GAUCHE



479524*

RETRO UNIVERSEL BCD F1 PRO D 8 NOIR DROIT



478749*

RETRO UNIVERSEL BCD F1 PRO D 8 NOIR GAUCHE



479117*

RETRO UNIVERSEL BCD TT D 8 NOIR/BLANC GAUCHE



479118*

RETRO UNIVERSEL BCD TT D 8 NOIR/NOIR GAUCHE



479525

RETRO DROIT BCD F1 PRO D8 CHROME*



496687*

RETRO SCOOTER DROIT OEM PIAGGIO TYPHOON 11->/SR MOTARD/RX/NEXUS 125/TUONO 1000 (E113D)



496686*

RETRO SCOOTER GAUCHE OEM PIAGGIO TYPHOON 11->/SR MOTARD/SX/NEXUS 125/TUONO 1000 (E113I)



511032*

RETRO MECABOITE/MOTO DROIT OEM MASH 50 FIFTY/125 SCRAMBLER/SEVENTY FIVE



511033*

RETRO MECABOITE / MOTO GAUCHE MOTO ADAPT. MASH 50 FIFTY / 125 SCRAMBLER / SEVENTY FIVE



500172

RETRO UNIVERSEL STAGE6 F1 BLANC GAUCHE



500176

RETRO UNIVERSEL STAGE6 F1 CARBONE MAT DROIT



500170

RETRO UNIVERSEL STAGE6 F1 CARBONE MAT GAUCHE



500175

RETRO UNIVERSEL STAGE6 F1 CARBONE VERNI DROIT



500169

RETRO UNIVERSEL STAGE6 F1 CARBONE VERNI GAUCHE



500177

RETRO UNIVERSEL STAGE6 F1 CHROME VERNI DROIT



500171

RETRO UNIVERSEL STAGE6 F1 CHROME VERNI GAUCHE



500174

RETRO UNIVERSEL STAGE6 F1 NOIR DROIT



500168

RETRO UNIVERSEL STAGE6 F1 NOIR GAUCHE



500173

RETRO UNIVERSEL STAGE6 F1 ALUMINIUM DROIT



500167

RETRO UNIVERSEL STAGE6 F1 ALUMINIUM GAUCHE

RÉTROVISEUR & BEQUILLE / WING MIRROR & STAND

MOTEUR

CYCLE

PNEUMATIQUE

ATELIER

ACCESSOIRES

ÉLECTRICITÉ

FILTRATION

FREINAGE

TRANSMISSION



/ ADAPTATEUR RETRO FEMELLE



511962

511963

511965

511964

511967

511966

Désignation	Réf.
M10 PAS A DROITE / MALE M10 PAS A GAUCHE	511962
M10 PAS A DROITE / MALE M8 PAS A DROITE	511963
M8 PAS A DROITE / MALE M10 PAS A DROITE	511965
M8 PAS A DROITE / MALE M8 PAS A GAUCHE	511964
M8 PAS A GAUCHE / MALE M10 PAS A DROITE	511967
M8 PAS A GAUCHE / MALE M8 PAS A DROITE	511966



/ ADAPTATEUR RETRO FEMELLE



387376

484313

479316

Désignation	Réf.
M8 PAS A DROITE / MALE M10 PAS A DROITE	387376
M8 PAS A GAUCHE / MALE M10 PAS A DROITE	484313
M8 PAS A GAUCHE / MALE M8 PAS A DROITE	479316



/ KIT ADAPTATEUR RETRO 3 PIECES



Désignation	Réf.
M8 GAUCHE/M10 DROIT/M10 GAUCHE	479592



/ KIT ADAPTATEUR RETRO UNIVERSEL 3 PIECES



Désignation	Réf.
M8 GAUCHE/M10 DROIT/M10 GAUCHE	511707

/ BEQUILLE LATERALE



461568



BEQUILLE MAXI SCOOTER LATERALE BUZZETTI ADAPT. 125/150/200 LIBERTY NOIR



487377



BEQUILLE MAXI SCOOTER LATERALE BUZZETTI ADPAT. 125 LIBERTY 4 TEMPS 2014->



504132



BEQUILLE MECABOITE LATERALE OEM RIEJU 50 MRT PRO/MRT/125 MARATHON/TANGO (0/000.210.8000)



497075



BEQUILLE MECABOITE/MOTO LATERALE ADAPT. APRILIA 50/125 RS4/DERBI 50/125 GPR 2010->/TUONO



511009



BEQUILLE MECABOITE/MOTO LATERALE ADAPT. MASH 50 FIFTY/DIRT TRACK/125 SEVENTY



490326



BEQUILLE MECABOITE/MOTO LATERALE ADAPT. RIEJU 50 MRT PRO/MRT/125 MARATHON/TANGO



497073



BEQUILLE MECABOITE/MOTO LATERALE ADAPT. RIEJU 50/125 RS2/NKD



497074



BEQUILLE MECABOITE/MOTO LATERALE ADAPT. RIEJU 50/125 RS3/NKD

/ BEQUILLE CENTRALE



483446
BEQUILLE MAXI CENTRALE ADAPT. 125/150
LIBERTY/LOOXOR



485714
BEQUILLE MAXI SCOOTER CENTRALE
ADAPT. 125 SH HONDA



485716
BEQUILLE MAXI SCOOTER CENTRALE
ADAPT. 125/150 KYMCO GRAND DINK



449952
BEQUILLE SCOOTER CENTRALE ADAPT.
OVETTO/NEOS 50/100/MACH G/JOG R
>07/F12/F15 NOIR



483443
BEQUILLE SCOOTER/MAXI CENTRALE
ADAPT. 50/125/150 VESPA ET4/LX/ ZIP 4
TEMPS NOIR

/ PLAQUETTE BEQUILLE



504129
PLAQUETTE BEQUILLE LATÉRALE
MECABOITE OEM RIEJU MRT/MRT PRO
125 MARATHON (0/000.980.5102)



504247
PLAQUETTE BEQUILLE LATÉRALE
MECABOITE OEM RIEJU RS3 125
MARATHON (0/000.980.7028)

/ RESSORT BEQUILLE LATÉRALE



450508
BUZZETTI L85 D12X1.5

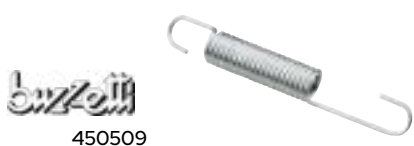

450509
BUZZETTI L93 D12X1.8



504131
MECABOITE OEM RIEJU MRT/MRT PRO
(0/000.470.8000) (PR)



511010
MECABOITE/MOTO ADAPT. MASH 50
FIFTY/DIRT TRACK/125 SEVENTY



511012
MECABOITE/MOTO ADAPT. MASH 50
FIFTY/DIRT TRACK/125 SEVENTY -

MOTEUR

CYCLE

PNEUMATIQUE

ATELIER

ACCESSOIRES

ÉLECTRICITÉ

FILTRATION

FREINAGE

TRANSMISSION



/ DIABOLO MOTO



Désignation	Réf.
M10X125 (PR) - ARGENT	506804
M6X125 (PR) - ARGENT	506800
M8X125 (PR) - ARGENT	506802
M10X125 (PR) - NOIR	506803
M6X125 (PR) - NOIR	506799
M8X125 (PR) - NOIR	506801



/ PEDALE FREIN



504136 504137

Désignation	Réf.
PEDALE FREIN MECABOITE OEM RIEJU MRT/MRT PRO (0/000.730.0731)	504136
PEDALE FREIN MECABOITE/MOTO OEM RIEJU 50/125 RS3 (0/000.730.7002)	504137



/ GOUPILLE PEDALE FREIN



Désignation	Réf.
GOUPILLE PEDALE FREIN MECABOITE OEM RIEJU MRT 2009-> (0/000.840.0090) -	504106



/ MARCHE-PIEDS



Désignation	Réf.
MARCHE PIED MAXI SCOOTER TUN'R ADAPT. 500 YAMAHA TMAX ALU ARGENT (2 PIECES)	468249



/ RESSORT REPOSE PIED



504097



504135



504145



504134

Désignation	Réf.
FREIN MECABOITE OEM RIEJU 50/125 RS3 (0/000.470.7001)	504097
FREIN MECABOITE OEM RIEJU MRT/MRT PRO (0/000.470.5011)	504135
REPOSE PIED PILOTE DROIT MECABOITE OEM RIEJU MRT/MRX/SMX (0/000.470.5001)	504145
REPOSE PIED PILOTE GAUCHE MECABOITE OEM RIEJU MRT/MRX/SMX (0/000.470.5002)	504134

/ REPOSE/CALE PIED



504140



REPOSE/CALE PIED MECABOITE PASSAGER OEM RIEJU MRT/MRX/SMX/RR (0/000.740.0330)



517019



REPOSE/CALE PIED MECABOITE PILOTE DROIT OEM RIEJU MRT / MARATHON PRO (0/000.740.0301)



504143



REPOSE/CALE PIED MECABOITE PILOTE DROIT OEM RIEJU MRT/MRX/SMX / MARATHON PRO (0/000.740.0300)



517020



REPOSE/CALE PIED MECABOITE PILOTE GAUCHE OEM RIEJU MRT / MARATHON PRO (0/000.740.0311)



504144



REPOSE/CALE PIED MECABOITE PILOTE GAUCHE OEM RIEJU MRT/MRX/SMX / MARATHON PRO (0/000.740.0310)



511036



REPOSE/CALE PIED MECABOITE/MOTO PASSAGER DROIT ADAPT. MASH 50 FIFTY/125 SEVENTY FIVE/SCRAM



511037



REPOSE/CALE PIED MECABOITE/MOTO PASSAGER GAUCHE ADAPT. MASH 50 FIFTY/125 SEVENTY FIVE/SCR



511035



REPOSE/CALE PIED MECABOITE/MOTO PILOTE DROIT ADAPT. MASH 50 FIFTY/125 SEVENTY FIVE/SCRAMBL



511034



REPOSE/CALE PIED MECABOITE/MOTO PILOTE GAUCHE ADAPT. MASH 50 FIFTY/125 SEVENTY FIVE/SCRAMB



/ SUPPORT REPOSE PIED



504142



504141

Désignation	Réf.
SUPPORT REPOSE PIED MECABOITE PASSAGER DROIT OEM RIEJU MRT/MRT PRO (0/000.980.5107)	504142
SUPPORT REPOSE PIED MECABOITE PASSAGER GAUCHE OEM RIEJU MRT/MRT PRO (0/000.980.5108)	504141



/ AXE KICK



485721



516981

Désignation	Réf.
AXE KICK MAXI SCOOTER TEKNIX ADAPT. PIAGGIO LIBERTY/VESPA/ZIP MOTEUR LEADER (830284)	485721
AXE KICK MAXI SCOOTER TEKNIX ADAPT. PIAGGIO/APRILIA/GILERA 125/150/180 (434087)	516981



/ NOIX KICK



Désignation	Réf.
NOIX KICK MAXI SCOOTER TEKNIX ADAPT. PIAGGIO LIBERTY/VESPA/ZIP (483539)	485720

/ MANCHON/PROTECTION CAOUTCHOUC POUR KICK UNIVERSEL



508536

L35MM-DIA INTERIEUR 8MM



484624

L40MM



520753



520756



520755



520754



520757



520758



520759

/ ROULEMENT DE ROUE

Désignation	Réf.
ROULEMENT ROUE 60/22-2RS KOYO (D22X44 EP12)	520753
ROULEMENT ROUE 60/28-2RS KOYO (D28X52 EP12)	520756
ROULEMENT ROUE 60/32-2RS KOYO (D32X58 EP13)	520755
ROULEMENT ROUE 62/22-2RS KOYO (D22X50 EP14)	520754
ROULEMENT ROUE 62/28-2RS KOYO (D28X58 EP16)	520757
ROULEMENT ROUE 62/32-2RS KOYO (D32X65 EP17)	520758
ROULEMENT ROUE 63/22-2RS KOYO (D22X56 EP16)	520759

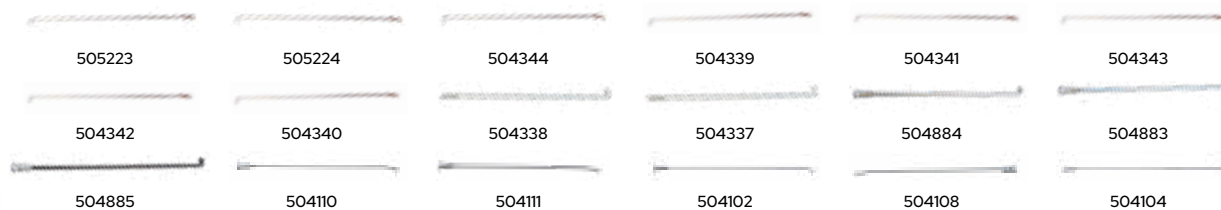

/ RAYON

Désignation	SELECTION CGN MOTORISE	SELECTION CGN CYCLE	RIEJU
RAYON 2.3 MM INOX ARGENT L162 AVEC ECROU (XI) MACHI CYCLO/MOTO/VAE	505223		
RAYON 2.3 MM INOX ARGENT L166 AVEC ECROU (XI) MACHI CYCLO/MOTO/VAE	505224		
RAYON 2.3 MM INOX ARGENT L172 AVEC ECROU (XI) MACHI CYCLO/MOTO/VAE	504344		
RAYON 2.3 MM INOX ARGENT L179 AVEC ECROU (XI) MACHI CYCLO/MOTO/VAE	504339		
RAYON 2.3 MM INOX ARGENT L192 AVEC ECROU (XI) MACHI CYCLO/MOTO/VAE	504341		
RAYON 2.3 MM INOX ARGENT L198 AVEC ECROU (XI) MACHI CYCLO/MOTO/VAE	504343		
RAYON 2.3 MM INOX ARGENT L220 AVEC ECROU (XI) MACHI CYCLO/MOTO/VAE	504342		
RAYON 2.3 MM INOX ARGENT L224 AVEC ECROU (XI) MACHI CYCLO/MOTO/VAE	504340		
RAYON 3.00MM ACIER GALVANISE L180 (XI) CYCLO/MOTO		504338	
RAYON 3.00MM ACIER GALVANISE L195 AVEC ECROU (XI) CYCLO/MOTO		504337	
RAYON 3.00MM INOX L180 AVEC ECROU (XI) CYCLO/MOTO		504884	
RAYON 3.00MM INOX L195 AVEC ECROU (XI) CYCLO/MOTO		504883	
RAYON 3.50MM INOX NOIR L195 AVEC ECROU (XI) CYCLO/MOTO		504885	
RAYON ROUE AR 17" MECABOITE OEM RIEJU MRT/SMX (0/000.540.5008) L194X3.5			504110
RAYON ROUE AR 17" MECABOITE OEM RIEJU MRT/SMX (0/000.540.5009) L199X3.5			504111
RAYON ROUE AR 18" MECABOITE OEM RIEJU MRX/RR/SMX (0/000.540.0160)			504102
RAYON ROUE AV 17" MECABOITE OEM RIEJU MRT/SMX/RMX (0/000.540.5010) L195X3.08			504108
RAYON ROUE AV 21" MECABOITE OEM RIEJU MRX/RR/SMX (0/000.540.5000)			504104

/ ECROU DE RAYON

Désignation	Réf.
ECROU RAYON 2.50MM (XI) CYCLO/MECABOITE/MOTOw	509734
ECROU RAYON 3.00MM (XI) CYCLO/MECABOITE/MOTO	509735
ECROU RAYON 3.50MM (XI) CYCLO/MECABOITE/MOTO	509736
ECROU RAYON 4.00MM (XI) CYCLO/MECABOITE/MOTO	509737



/ JEU DE DIRECTION MOTO



SCOOTER/MAXI SCOOTER TEKNIX ADAPT. 50/125 PIAGGIO FLY/ZIP/LIBERTY/NRG



SCOOTER/MAXI SCOOTER TEKNIX ADAPT. 50/125/150 TWEET/FIDDLE II/SYMPHONY



JEU DIRECTION MOTO TEKNIX ADAPT. 125 YAHAMA YBR 2008->

/ JEU DE DIRECTION SCOOTER & MAXI SCOOTER



479325

MAXI SCOOTER ADAPT.125
XMAX/SKYCRUISER ->2009



491446

MAXI SCOOTER BUZZETTI ADAPT. 500
YAMAHA TMAX 2001-2007



491447

MAXI SCOOTER BUZZETTI
ADAPT. 500/530 YAMAHA TMAX 2008->



491445

MAXI SCOOTER BUZZETTI ADAPT.125/300
KYMCO DOWNTOWN/300 HONDA SH



483058

MAXI SCOOTER TEKNIX
ADAPT. 125 FLAME X/CYGNUS



499436

MAXI SCOOTER TEKNIX
ADAPT. 125 HONDA SH



499437

MAXI SCOOTER TEKNIX ADAPT. 125
KYMCO DOWNTOWN / HONDA 300 SH



499245

MAXI SCOOTER TEKNIX
ADAPT. 125 PIAGGIO X-EVO



486075

MAXI SCOOTER TEKNIX
ADAPT. 125 XMAX/SKYCRUISER 2010-2013



499244

MAXI SCOOTER TEKNIX
ADAPT. 125 YAMAHA/MBK TRIPTIK/TRICITY



499247

MAXI SCOOTER TEKNIX
ADAPT. 300 YAMAHA/MBK XMAX/EVOLIS



483328

MAXI SCOOTER TEKNIX
ADAPT. 125 HONDA SH/DYLAN



499241

MAXI SCOOTER TEKNIX
ADAPT. 125 PEUGEOT CITYSTAR



499243

MAXI SCOOTER TEKNIX
ADAPT. 125 YAMAHA/MBK XENTER/OCEO



491448

SCOOTER/MAXI SCOOTER BUZZETTI ADAPT.
50/125/150 TWEET/FIDDLE II/SYMPHONY



/ FOURCHE



Désignation	Réf.
FOURCHE SCOOTER/MAXI SCOOTER OEM PIAGGIO 50/125 SR MOTARD 2T ET 4T/TYPHOON 10-> (668484)	500473



511029

511030

518096

504225

504253

/ TUBE DE FOURCHE MECABOITE/MOTO

Désignation	MASH	RIEJU
DROIT ADAPT. MASH 50 FIFTY/125 SCRAMBLER/SEVENTY	511029	
GAUCHE ADAPT. MASH 50 FIFTY/125 SCRAMBLER/SEVENTY	511030	
OEM RIEJU 50/125 MRT ->2011 (0/000.290.6104) (X1)		518096
OEM RIEJU 50/125 MRT/MARATHON Ø37MM (0/K00.290.0001) (X1)		504225
OEM RIEJU 50/125 RS3 ->2017 (0/000.290.7212) (X1)		504253



/ TUBE DE FOURCHE

Désignation	Réf.
MAXI SCOOTER OEM 125 XMAX/SKYCRUISER/EVOLIS (37PF31100000)(X1)	510508



/ TE DE FOURCHE

Désignation	Réf.
MECABOITE/MOTO INFERIEUR ADAPT. MASH 50 FIFTY/DIRT TRACK/125 SCRAMBLER/SEVEN	511028



508548

499710

/ ROULEMENT DE DIRECTION

Désignation	RIEJU	FAG
ROULEMENT DE DIRECTION OEM RIEJU 50 MRT 0/000.960.0200	508548	
ROULEMENT FOURCHE/DIRECTION 32005 FAG ROULEAUX CONIQUES (D25X47 EP15) (X1)		499710

/ JOINT MOTO

				
Modèle	Cylindre	Année début	Année fin	Réf.
APRILIA				
AF1 EUROPA / FUTURA	125	1987	1987	512011
AF1 FUTURA / REPLICA	125	1988	1991	512016
AF1 FUTURA / REPLICA	125	1992	1992	512016
AF1 SINTESI / REPLICA / SPORT	125	1989	1989	512016
AF1 SINTESI / REPLICA / SPORT	125	1990	1990	512016
AF1 SINTESI / REPLICA / SPORT	125	1988	1988	512017
AF1 SINTESI / REPLICA / SPORT	125	1989	1989	512017
AF1 EUROPA / FUTURA	125	1990	1991	480623
AF1 EUROPA / FUTURA	125	1992	1992	480623
AF1 FUTURA / REPLICA	125	1992	1992	512035
ETX	125	1985	1985	493905
ETX	125	1986	1986	493905
ETX	125	1987	1987	493905
EUROPA	125	1990	1990	512017
EUROPA	125	1991	1991	512017
EUROPA	125	1991	1991	512035
EUROPA	125	1992	1993	512035
PEGASO	125	1989	1989	512017
PEGASO	125	1990	1990	512017
PEGASO	125	1991	1991	480623
PEGASO	125	1992	1992	480623
PEGASO	125	1993	1994	480623
RED ROSE	125	1987	1987	493905
RED ROSE	125	1988	1988	493905
RED ROSE	125	1989	1989	493905
RED ROSE	125	1990	1994	493905
RED ROSE	125	1988	1988	512034
RED ROSE	125	1989	1989	512034
RS REPLICA	125	1992	1994	480623
RS REPLICA	125	1995	1995	480623
RS REPLICA	125	1996	1998	480623
RS REPLICA	125	1999	1999	480623
RS REPLICA	125	2006	2006	486025
RS REPLICA	125	2007	2007	486025
RS REPLICA	125	2008	2010	486025
RS REPLICA	125	2006	2006	485241
RS REPLICA	125	2007	2007	485241
RS REPLICA	125	2008	2010	485241
RS-4	125	2011	2011	493903
RS-4	125	2012	2013	493903

				
Modèle	Cylindre	Année début	Année fin	Réf.
RS-4	125	2014	2016	493903
RS-4	125	2017	2017	493903
RX	125	1985	1985	480623
RX	125	1986	1989	480623
RX	125	1992	1992	480623
RX	125	1990	1990	512025
RX	125	1991	1991	512025
RX	125	2008	2008	486025
RX	125	2008	2008	485241
RX	125	2009	2010	485241
SX	125	2008	2008	486025
SX	125	2008	2008	485241
SX	125	2009	2010	485241
TC	125	1985	1985	493905
TUAREG	125	1985	1985	493905
TUAREG	125	1986	1986	493905
TUAREG	125	1987	1987	493905
TUAREG WIND	125	1990	1990	512016
TUAREG WIND	125	1991	1991	512016
TUAREG WIND	125	1988	1988	512017
TUAREG WIND	125	1989	1989	512017
TUAREG RALLY	125	1985	1985	480623
TUAREG RALLY	125	1986	1986	480623
TUAREG RALLY	125	1987	1988	480623
TUAREG RALLY	125	1989	1989	480623
TUAREG RALLY	125	1990	1990	480623
TUAREG RALLY	125	1991	1991	480623
TUAREG RALLY	125	1992	1992	480623
TUAREG RALLY	125	1990	1990	512025
TUONO	125	2017	2017	493903
RS	250	1995	1996	480623
RS	250	1997	1997	480623
RX	250	1983	1985	480623
TUAREG RALLY	250	1984	1984	480623
ETX	350	1985	1985	512017
ETX	350	1986	1986	512017
ETX	350	1987	1989	512017
TUAREG WIND	350	1986	1986	480623
TUAREG WIND	350	1987	1987	480623
TUAREG WIND	350	1988	1988	512037
TUAREG WIND	350	1989	1989	512037
TUAREG WIND	350	1990	1990	512037
TUAREG SPX / PARIS DAKAR / WIND	600	1988	1988	512037
TUAREG SPX / PARIS DAKAR / WIND	600	1989	1989	512037

MOTEUR

CYCLE

PNEUMATIQUE

ATELIER

ACCESSOIRES

ÉLECTRICITÉ

FILTRATION

FREINAGE

TRANSMISSION

ATHENA				
Modèle	Cylindre	Année début	Année fin	Réf.
TUAREG SPX / PARIS DAKAR / WIND	600	1990	1990	512037
TUAREG SPX / PARIS DAKAR / WIND	600	1991	1993	512037
MOTO 6.5	650	1995	1995	480623
MOTO 6.5	650	1996	1999	480623
PEGASO	650	1992	1993	480623
PEGASO	650	1994	1994	480623
PEGASO	650	1995	1995	480623
PEGASO	650	1996	1996	480623
PEGASO	650	1997	1998	480623
PEGASO	650	1992	1993	512035
PEGASO	650	1989	1989	512037
TUAREG UPSIDE DOWN	650	1993	1994	512035
DORSODURO	750	2008	2008	512189
DORSODURO	750	2009	2014	512189
DORSODURO	750	2015	2015	512189
DORSODURO	750	2008	2008	512203
DORSODURO	750	2009	2014	512203
DORSODURO	750	2015	2015	512203
SHIVER	750	2007	2007	512189
SHIVER	750	2008	2013	512189
SHIVER	750	2014	2014	512189
SHIVER GT	750	2009	2012	512189
MANA GT	850	2008	2008	512189
MANA GT	850	2009	2009	512189
MANA GT	850	2010	2011	512189
MANA GT	850	2012	2012	512189
MANA GT	850	2009	2009	512203
MANA GT	850	2010	2011	512203
MANA GT	850	2012	2012	512203
ETV CAPONORD / RALLY / ABS	1000	2001	2001	512044
ETV CAPONORD / RALLY / ABS	1000	2002	2005	512044
RSV R	1000	2000	2000	512177
RSV R	1000	2001	2003	512177
RSV R	1000	2004	2004	512177
RSV R	1000	2005	2005	512177
RSV R	1000	2006	2007	512177
RSV R FACTORY / DREAM	1000	2000	2002	512177
RSV R FACTORY / DREAM	1000	2003	2003	512177
RSV R FACTORY / DREAM	1000	2004	2006	512177
RSV R FACTORY / DREAM	1000	2007	2007	512177

ATHENA				
Modèle	Cylindre	Année début	Année fin	Réf.
RSV TUONO FIGHTER	1000	2000	2002	512177
RSV TUONO FIGHTER	1000	2003	2003	512177
RSV TUONO FIGHTER	1000	2004	2005	512177
RSV TUONO FIGHTER	1000	2006	2007	512177
RSV TUONO R	1000	2000	2001	512177
RSV TUONO R	1000	2002	2002	512177
RSV TUONO R	1000	2003	2003	512177
RSV TUONO R	1000	2004	2004	512177
RSV TUONO R	1000	2005	2005	512177
RSV TUONO R	1000	2006	2006	512177
RSV TUONO R	1000	2007	2009	512177
RSV4 R/FACTORY/ ABS	1000	2010	2010	512120
RSV4 R/FACTORY/ ABS	1000	2009	2009	512177
RSV4 R/FACTORY/ ABS	1000	2010	2010	512177
RSV4 R/FACTORY/ ABS	1000	2011	2013	512177
RSV4 R/FACTORY/ ABS	1000	2014	2014	512177
RSV4 R/FACTORY/ ABS	1000	2015	2015	512177
RSV4 R/FACTORY/ ABS	1000	2011	2013	512203
RSV4 R/FACTORY/ ABS	1000	2014	2014	512203
RSV4 R/FACTORY/ ABS	1000	2015	2015	512203
RSV4 R/FACTORY/ ABS	1000	2016	2019	512203
TUONO R	1000	2000	2001	512177
TUONO R	1000	2002	2003	512177
TUONO R	1000	2004	2004	512177
TUONO R	1000	2005	2007	512177
TUONO V4 R STD - APRC	1000	2011	2013	512203
TUONO V4 R STD - APRC	1000	2014	2014	512203
TUONO V4	1100	2015	2019	512203
CAPONORD RALLY	1200	2013	2015	512203
DORSODURO	1200	2011	2012	512203
DORSODURO	1200	2013	2013	512203
BENELLI				
125	125	1978	1982	512038
2T	125	1978	1978	512038
250	250	1980	1982	512038
350 4 CIL	350	1978	1978	512038
500 FD	500	-	-	512035
750 FD	750	-	-	512035
BMW				
F GS	650	1999	2007	480620
F GS	650	2008	2008	480620
F CS	650	2000	2001	512197
F CS	650	2002	2005	512197
G GS	650	2006	2007	512047

ATHENA				
Modèle	Cylindre	Année début	Année fin	Réf.
G Xchallenge/Xcountry/Xmoto	650	2006	2006	512047
G Xchallenge/Xcountry/Xmoto	650	2007	2007	512047
G Xchallenge/Xcountry/Xmoto	650	2008	2008	512047
G Xchallenge/Xcountry/Xmoto	650	2009	2009	512047
G Xchallenge/Xcountry/Xmoto	650	2006	2006	512194
G Xchallenge/Xcountry/Xmoto	650	2007	2007	512194
G Xchallenge/Xcountry/Xmoto	650	2008	2008	512194
G Xchallenge/Xcountry/Xmoto	650	2009	2009	512194
G Xchallenge/Xcountry/Xmoto	650	2010	2010	512194
G GS	650	2010	2015	512197
R65	650	1985	1987	512206
F GS	700	2013	2015	512197
F GS	700	2016	2017	512197
F GS	700	2018	2018	512197
K75	750	1985	1995	512205
F GS	800	2006	2006	512047
F GS	800	2007	2007	512047
F GS	800	2008	2012	512047
F R	800	2005	2008	512180
F R	800	2009	2009	512180
F R	800	2010	2014	512180
F R	800	2015	2015	512180
F S	800	2004	2005	512180
F S	800	2006	2008	512180
F S	800	2009	2009	512180
F S	800	2010	2010	512180
F ST	800	2004	2005	512180
F ST	800	2006	2007	512180
F ST	800	2008	2009	512180
F ST	800	2010	2012	512180
F GS	800	2006	2006	512194
F GS	800	2007	2007	512194
F GS	800	2008	2012	512194
F 650 GS	800	2007	2007	512197
F 650 GS	800	2008	2012	512197
F GS	800	2013	2017	512202
F GS	800	2018	2018	512202
R C	850	1997	1998	493902
R C	850	1999	1999	493902

ATHENA				
Modèle	Cylindre	Année début	Année fin	Réf.
R C	850	2000	2000	493902
R GS	850	1996	1998	493902
R GS	850	1999	1999	493902
R GS	850	2000	2000	493902
R R	850	1994	1994	493902
R R	850	1995	1999	493902
R R	850	2000	2006	493902
R R	850	2007	2007	493902
R RT	900	2005	2009	493902
R RT	900	2010	2010	493902
K 100 SERIES	1000	1983	1990	512023
K 100 LT	1000	1986	1986	512205
K 100 LT	1000	1987	1987	512205
K 100 LT	1000	1988	1991	512205
K 100 RT	1000	1984	1988	512205
KI	1000	1989	1989	512204
KI	1000	1990	1992	512204
K100 RS	1000	1990	1992	512204
K100 RS	1000	1984	1989	512205
K100	1000	1984	1986	512205
R 100 RS / RT	1000	1986	1986	512019
R100 RS	1000	1987	1992	512206
R100 RT	1000	1987	1995	512206
S R	1000	2013	2013	512211
S R	1000	2014	2016	512211
S R	1000	2017	2017	512211
S RR	1000	2008	2008	512211
S RR	1000	2009	2009	512211
S RR	1000	2010	2016	512211
S RR	1000	2017	2017	512211
S RR HP4	1000	2011	2011	512211
S RR HP4	1000	2012	2014	512211
S RR HP4	1000	2015	2015	512211
K LT / RS	1100	1992	1997	512204
R GS	1100	1994	1997	493902
R GS	1100	1998	1999	493902
R GS	1100	2000	2006	493902
R R	1100	1993	1993	493902
R R	1100	1994	1998	493902
R R	1100	1999	1999	493902
R R	1100	2000	2001	493902
R RS	1100	1992	1992	493902
R RS	1100	1993	1993	493902
R RS	1100	1994	1997	493902
R RS	1100	1998	2001	493902

ATHENA				
Modèle	Cylindre	Année début	Année fin	Réf.
R RT	1100	1994	1994	493902
R RT	1100	1995	1995	493902
R RT	1100	1996	1997	493902
R RT	1100	1998	1998	493902
R RT	1100	1999	2001	493902
R S	1100	1996	1998	493902
R S	1100	1999	2000	493902
R S	1100	2001	2004	493902
R S	1100	2005	2005	493902
R GS	1150	1998	1999	493902
R GS	1150	2000	2000	493902
R GS	1150	2001	2001	493902
R GS	1150	2002	2002	493902
R GS	1150	2003	2003	493902
R GS ADVENTURE	1150	2001	2001	493902
R GS ADVENTURE	1150	2002	2003	493902
R R	1150	1999	1999	493902
R R	1150	2000	2000	493902
R R	1150	2001	2001	493902
R R	1150	2002	2002	493902
R R	1150	2003	2006	493902
R RS	1150	2000	2000	493902
R RS	1150	2001	2001	493902
R RS	1150	2002	2004	493902
R RT	1150	2000	2000	493902
R RT	1150	2001	2006	493902
HP2 ENDURO	1200	2004	2005	512047
HP2 ENDURO	1200	2006	2006	512047
HP2 MEGAMOTO	1200	2006	2006	512047
HP2 MEGAMOTO	1200	2007	2007	512047
HP2 MEGAMOTO	1200	2008	2008	512047
HP2 ENDURO	1200	2004	2005	512194
HP2 ENDURO	1200	2006	2006	512194
HP2 MEGAMOTO	1200	2006	2006	512194
HP2 MEGAMOTO	1200	2007	2007	512194
HP2 MEGAMOTO	1200	2008	2008	512194
HP2 SPORT	1200	2007	2007	512197
HP2 SPORT	1200	2008	2008	512197
HP2 SPORT	1200	2009	2010	512197
K GT	1200	2002	2005	493902
K LT	1200	1997	1998	493902
K LT	1200	1999	2000	493902
K LT	1200	2001	2008	493902
K RS	1200	2000	2000	493902
K RS	1200	2001	2003	493902

ATHENA				
Modèle	Cylindre	Année début	Année fin	Réf.
K RS	1200	2004	2004	493902
K RS	1200	2005	2005	493902
R C	1200	1996	1996	493902
R C	1200	1997	1997	493902
R C	1200	1998	1998	493902
R C	1200	1999	2002	493902
R C	1200	2003	2003	493902
R GS / ADVENTURE	1200	1994	2002	493902
R GS / ADVENTURE	1200	2003	2003	493902
R R	1200	2005	2006	493902
R R	1200	2007	2009	493902
R R	1200	2010	2011	493902
R ST/RT	1200	2003	2004	493902
R ST/RT	1200	2005	2005	493902
R ST/RT	1200	2006	2009	493902
R GS / ADVENTURE	1200	2004	2005	512197
R GS / ADVENTURE	1200	2006	2008	512197
R GS / ADVENTURE	1200	2009	2009	512197
R GS / ADVENTURE	1200	2010	2012	512197
R GS / ADVENTURE	1200	2013	2013	512197
R R	1200	2012	2013	512197
R R	1200	2014	2014	512197
R R	1200	2015	2015	512197
R ST/RT	1200	2010	2010	512197
R ST/RT	1200	2011	2012	512197
R ST/RT	1200	2013	2013	512197
R nineT	1200	2013	2013	512211
R nineT	1200	2014	2015	512211
R GS / ADVENTURE	1200	2014	2017	512212
R GS / ADVENTURE	1200	2018	2018	512212
R ST/RT	1200	2014	2015	512212
R ST/RT	1200	2016	2018	512212
R GS / ADVENTURE	1200	2014	2017	512213
R GS / ADVENTURE	1200	2018	2018	512213
R ST/RT	1200	2014	2015	512213
R ST/RT	1200	2016	2018	512213
R GS	1250	2019	2019	512212
R GS	1250	2019	2019	512213
ALL MODELS		1970	1983	512009
ALL MODELS		1984	1984	512009
ALL MODELS		1984	1984	512019
BOGE				
35 MM FORK TUBES		-	-	493905
BUELL				
M2 CYCLONE	1200	1997	1997	512028

ATHENA				
Modèle	Cylindre	Année début	Année fin	Réf.
M2 CYCLONE	1200	1998	2000	512028
S1 LIGHTNING	1200	1999	2000	512026
S3 T THUNDERBOLT	1200	1999	2000	512026
CAGIVA				
BLUES	125	1988	1988	493905
BLUES	125	1989	1992	493905
CRUISER	125	1987	1987	493905
CRUISER	125	1988	1988	493905
CRUISER	125	1989	1989	493905
ELEFANT 2	125	1984	1988	493905
ELEFANT 3	125	1986	1986	493905
ELEFANT 3	125	1987	1987	493905
ELEFANT 3	125	1988	1988	493905
FRECCIA C9 / C10 / C12 / SP	125	1987	1987	493905
FRECCIA C9 / C10 / C12 / SP	125	1988	1988	493905
FRECCIA C9 / C10 / C12 / SP	125	1989	1989	493905
FRECCIA C9 / C10 / C12 / SP	125	1990	1990	493905
FRECCIA C9 / C10 / C12 / SP	125	-	-	512033
MITO	125	1992	1992	480623
MITO	125	1993	1994	480623
N 90	125	1990	1990	480623
N	125	1990	1990	480623
SUPERCITY	125	-	-	480623
TAMANACO	125	1987	1988	480623
TAMANACO	125	1989	1989	480623
ELEFANT 2	200	1985	1985	493905
ELEFANT 2	200	1986	1986	493905
T4 E / R	350	1984	1984	480623
T4	500	1987	1987	480623
T4	500	1988	1988	480623
ELEFANT BIFARO	750	1987	1987	512036
ELEFANT BIFARO	750	1988	1988	512036
ELEFANT BIFARO	750	1989	1989	512036
LUCKY EXPLORER	750	1990	1994	512036
ELEFANT I.E	900	1990	1990	512036
ELEFANT I.E	900	1991	1991	512036
ELEFANT I.E	900	1992	1994	512036
GRAN CANYON	900	1998	1998	512047
GRAN CANYON	900	1999	1999	512047
GRAN CANYON	900	2000	2000	512047
DERBI				
GPR RACING	125	2004	2004	480623

ATHENA				
Modèle	Cylindre	Année début	Année fin	Réf.
GPR NUDE	125	2004	2004	486025
GPR NUDE	125	2005	2005	486025
GPR NUDE	125	2006	2006	486025
GPR NUDE SPORT	125	2004	2006	486025
MULHACEN EU3	125	2007	2007	480622
MULHACEN EU3	125	2008	2010	480622
TERRA EU3	125	2007	2007	480622
TERRA EU3	125	2008	2008	480622
DUCATI				
SUPERSPORT	350	1992	1992	512026
SUPERSPORT	350	1993	1993	512026
MONSTER	400	1995	1997	512049
MONSTER	400	2000	2000	512178
MONSTER	400	2001	2001	512178
MONSTER	400	2002	2002	512178
MONSTER DARK I.E	400	2005	2005	512189
MONSTER I.E	400	2005	2006	512189
MONSTER I.E	400	2007	2008	512189
MONSTER	400	2003	2003	512189
MONSTER	400	2004	2004	512189
SUPERSPORT	400	1992	1992	512026
SUPERSPORT	400	1993	1993	512026
SUPERSPORT	400	1993	1993	512049
SUPERSPORT	400	1994	1994	512049
SUPERSPORT	400	1995	1997	512049
MONSTER	600	1998	1998	512049
MONSTER DARK	600	1993	1997	512049
MONSTER DARK	600	1998	1998	512049
MONSTER DARK	600	1999	1999	512049
MONSTER	600	2000	2000	512178
MONSTER	600	2001	2001	512178
SUPERSPORT	600	1991	1993	512049
SUPERSPORT	600	1994	1994	512049
SUPERSPORT	600	1995	1995	512049
SUPERSPORT	600	1996	1997	512049
MONSTER I.E. / DARK / EUR / USA	620	2002	2002	512189
MONSTER I.E. / DARK / EUR / USA	620	2003	2006	512189
MONSTER IE / S	620	2002	2002	512189
MONSTER IE / S	620	2003	2003	512189
MONSTER	620	2004	2004	512189
SPORT	620	2003	2003	512189
INDIANA	650	1986	1986	480623
INDIANA	650	1987	1989	480623

ATHENA				
Modèle	Cylindre	Année début	Année fin	Réf.
MONSTER 659 / ABS (AUST-NZ)	660	2012	2012	512189
MONSTER 659 / ABS (AUST-NZ)	660	2013	2013	512189
MONSTER 659 / ABS (AUST-NZ)	660	2014	2014	512189
MONSTER	695	2007	2007	512189
MONSTER ABS	696	2012	2012	512176
MONSTER ABS	696	2013	2013	512176
MONSTER ABS	696	2014	2014	512176
MONSTER ABS	696	2008	2011	512180
748 BIPOSTO USA	748	1995	1998	512028
748 BIPOSTO USA	748	1999	1999	512028
748 RACING	748	1998	1999	512028
748 SP	748	1995	1997	512028
748 SP	748	1998	1998	512028
748 SP	748	1999	1999	512028
748 SPS	748	1998	1999	512028
748 BIPOSTO	748	1995	1997	512120
748 BIPOSTO	748	1998	1998	512120
748 BIPOSTO	748	1999	1999	512120
748 BIPOSTO	748	2000	2000	512120
748 BIPOSTO	748	2001	2001	512120
748 BIPOSTO USA	748	1995	1998	512120
748 BIPOSTO USA	748	1999	1999	512120
748 RACING	748	1998	1999	512120
748 SP	748	1995	1997	512120
748 SP	748	1998	1998	512120
748 SP	748	1999	1999	512120
748 SPS	748	1998	1999	512120
748 BIPOSTO	748	1995	1997	512178
748 BIPOSTO	748	1998	1998	512178
748 BIPOSTO	748	1999	1999	512178
748 BIPOSTO	748	2000	2000	512178
748 BIPOSTO	748	2001	2001	512178
748 RS	748	2000	2000	512178
748 S	748	2000	2000	512178
748 S	748	2001	2001	512178
748 S	748	2002	2002	512178
748 TESTA BASSA	748	2001	2001	512178
749 DARK	749	2004	2004	512178
749 DARK	749	2005	2006	512178
749 S EUROPA/USA	749	2005	2006	512178
749	749	2003	2003	512178
INDIANA	750	1987	1987	480623
INDIANA	750	1988	1990	480623

ATHENA				
Modèle	Cylindre	Année début	Année fin	Réf.
LAGUNA SECA	750	1986	1986	480623
LAGUNA SECA	750	1987	1987	480623
MONSTER	750	1996	1997	480623
MONSTER	750	1996	1997	512026
MONSTER CITY / CITY DARK	750	1999	1999	512049
MONSTER USA / DARK	750	1998	1998	512049
MONSTER USA / DARK	750	1999	1999	512049
MONSTER	750	1998	1998	512049
MONSTER	750	1999	1999	512049
MONSTER I.E	750	2000	2001	512178
MONSTER I.E	750	2002	2002	512178
MONSTER	750	2000	2000	512178
MONSTER	750	2001	2001	512178
MONTJUICH	750	1986	1986	480623
MONTJUICH	750	1987	1987	480623
PASO	750	1986	1986	512036
PASO	750	1987	1987	512036
PASO	750	1988	1988	512036
PASO	750	1989	1990	512036
SANTAMONICA	750	1987	1987	480623
SANTAMONICA	750	1988	1988	480623
SPORT	750	1988	1988	480623
SPORT	750	1989	1989	480623
SPORT	750	1990	1990	480623
SPORT	750	2001	2001	512189
SPORT	750	2002	2002	512189
SS SHOWA	750	1975	1975	512017
SS SHOWA	750	1991	1993	512026
SUPERSPORT I.E	750	2000	2000	512028
SUPERSPORT I.E	750	2001	2001	512028
SUPERSPORT I.E	750	2002	2002	512028
SUPERSPORT USA	750	1999	1999	512028
SUPERSPORT USA	750	1999	1999	512120
MONSTER	795	2013	2015	512176
HYPERMOTARD 2V	796	2010	2010	512189
HYPERMOTARD 2V	796	2011	2012	512189
MONSTER ABS	796	2012	2012	512176
MONSTER ABS	796	2013	2014	512176
MONSTER ABS	796	2015	2015	512176
MONSTER ABS	796	2010	2010	512180
MONSTER ABS	796	2011	2011	512180
MONSTER 795 / ABS	800	2012	2012	512189
MONSTER S2R / DARK / EUROPE / USA	800	2005	2007	512189
MONSTER	800	2003	2004	512189

ATHENA				
Modèle	Cylindre	Année début	Année fin	Réf.
SPORT	800	2003	2003	512189
SUPERSPORT	800	2003	2003	512178
SUPERSPORT EUROPE / USA	800	2005	2005	512189
SUPERSPORT	800	2004	2004	512189
HYPERMOTARD	821	2013	2015	512176
HYPERMOTARD	821	2016	2017	512176
HYPERSTRADA	821	2013	2015	512176
HYPERSTRADA	821	2016	2017	512176
MONSTER	821	2015	2017	512176
MONSTER	821	2018	2020	512176
848 NH / EVO	848	2009	2010	512189
848 NH / EVO	848	2011	2012	512189
STREETFIGHTER	848	2012	2012	512189
STREETFIGHTER	848	2013	2015	512189
SUPERBIKE EVO	848	2011	2012	512180
SUPERBIKE EVO	848	2013	2013	512180
851 SUPERBIKE BIPOSTO	851	1991	1992	512026
851 SUPERBIKE BIPOSTO	851	1993	1993	512026
851 SUPERSPORT / STRADA	851	1988	1988	512036
851 SUPERBIKE	851	1989	1989	512039
851 SUPERBIKE	851	1990	1990	512039
851 SUPERBIKE	851	1991	1992	512039
888 SUPERBIKE SPO / SP5	888	1992	1992	512026
888 SUPERBIKE SPO / SP5	888	1993	1993	512026
888 SUPERBIKE SPO / SP5	888	1994	1995	512026
888 SUPERBIKE STRADA	888	1992	1992	512026
888 SUPERBIKE STRADA	888	1993	1993	512026
888 SUPERBIKE STRADA	888	1994	1995	512026
888 SUPERBIKE USA	888	1994	1995	512026
DS DARMAH S / SS	900	1976	1983	512017
MH EVOLUZIONE	900	2001	2002	512189
MHR	900	1976	1976	512017
MONSTER CITY / CITY DARK	900	1999	1999	512026
MONSTER CROMO / SPECIAL	900	1998	1998	512026
MONSTER USA	900	1999	1999	512026
MONSTER	900	1993	1997	512026
MONSTER	900	1998	1998	512026
MONSTER	900	1999	1999	512026
MONSTER	900	1993	1997	512049
MONSTER I.E	900	2000	2000	512178
MONSTER I.E	900	2001	2001	512178

ATHENA				
Modèle	Cylindre	Année début	Année fin	Réf.
MONSTER I.E	900	2002	2002	512178
PASO 906	900	1988	1988	512036
PASO 906	900	1989	1989	512036
PASO 906	900	1990	1991	512036
SL SHOWA	900	1992	1992	512026
SL SHOWA	900	1993	1993	512026
SPORT I.E	900	2002	2002	512189
SUPERSPORT	900	1976	1977	512017
SUPERSPORT	900	1978	1978	512017
SUPERSPORT	900	1979	1983	512017
SUPERSPORT CR USA / FE	900	1998	1998	512026
SUPERSPORT SUPERLIGHT	900	1991	1996	512026
SUPERSPORT SUPERLIGHT	900	1997	1997	512026
SUPERSPORT	900	1990	1991	512026
SUPERSPORT	900	1992	1993	512026
SUPERSPORT	900	1994	1994	512026
SUPERSPORT USA	900	1998	1998	512028
SUPERSPORT USA	900	1999	1999	512028
SUPERSPORT SUPERLIGHT	900	1991	1996	512049
SUPERSPORT SUPERLIGHT	900	1997	1997	512049
SUPERSPORT USA	900	1998	1998	512120
SUPERSPORT USA	900	1999	1999	512120
SUPERSPORT I.E	900	2000	2000	512178
SUPERSPORT I.E	900	2001	2001	512178
SUPERSPORT I.E	900	2002	2002	512178
907 I.E. USA	907	1990	1990	512028
907 I.E. USA	907	1991	1992	512028
907 I.E	907	1990	1991	512039
907 I.E	907	1992	1992	512039
907 I.E	907	1993	1993	512039
907 I.E. USA	907	1990	1990	512120
907 I.E. USA	907	1991	1992	512120
916 BIPOSTO / SENNA	916	1994	1994	512028
916 BIPOSTO / SENNA	916	1995	1998	512028
916 SP	916	1994	1996	512028
916 USA	916	1994	1997	512028
916 BIPOSTO / SENNA	916	1994	1994	512120
916 BIPOSTO / SENNA	916	1995	1998	512120
916 SP	916	1994	1996	512120
916 USA	916	1994	1997	512120
916 SPORT TOURING ST4 / USA	916	1999	1999	512178

MOTEUR

CYCLE

PNEUMATIQUE

ATELIER

ACCESSOIRES

ÉLECTRICITÉ

FILTRATION

FREINAGE

TRANSMISSION

ATHENA				
Modèle	Cylindre	Année début	Année fin	Réf.
916 SPORT TOURING ST4 / USA	916	2000	2000	512178
916 SPORT TOURING ST4 / USA	916	2001	2001	512178
916 SPORT TOURING ST4 / USA	916	2002	2003	512178
MONSTER S4	916	2001	2001	512178
MONSTER S4	916	2002	2002	512178
MONSTER S4 FOGGY	916	2001	2001	512178
MONSTER S4 FOGGY	916	2002	2002	512178
944 ST2	944	1997	1997	512028
944 ST2	944	1998	1998	512028
944 ST2	944	1999	1999	512028
944 ST2	944	2000	2000	512028
944 ST2	944	2001	2001	512028
944 ST2	944	2002	2003	512028
944 ST2	944	1997	1997	512120
944 ST2	944	1998	1998	512120
944 ST2	944	1999	1999	512120
944 ST2	944	2000	2000	512120
944 ST2	944	2001	2001	512120
944 ST2	944	2002	2003	512120
DESMOSEDICI RR	989	2008	2008	512177
916 SPORT TOURING 4	996	1998	1998	512028
916 SPORT TOURING 4	996	1999	1999	512028
916 SPORT TOURING 4	996	2000	2000	512028
916 SPORT TOURING 4	996	2001	2001	512028
916 SPORT TOURING 4	996	2002	2002	512028
916 SPORT TOURING 4	996	2003	2004	512028
916 SPS	996	1997	1998	512028
916 RACING	996	1997	1997	512120
916 RACING	996	1998	1998	512120
916 SPORT TOURING 4	996	1998	1998	512120
916 SPORT TOURING 4	996	1999	1999	512120
916 SPS	996	1997	1998	512120
916 RACING	996	1997	1997	512178
916 RACING	996	1998	1998	512178
996 RACING	996	1999	1999	512028
996 RS	996	2000	2000	512028
996 RS	996	2001	2001	512028
996 SPECIAL USA	996	1999	1999	512028
996 SPECIAL USA	996	2000	2000	512028
996 SPECIAL USA	996	2001	2001	512028
996 SPS	996	1999	1999	512028
996 USA	996	1999	1999	512028
996	996	1999	1999	512028

ATHENA				
Modèle	Cylindre	Année début	Année fin	Réf.
996	996	2000	2000	512028
996	996	2001	2001	512028
996 RACING	996	1999	1999	512120
996 RS	996	2000	2000	512120
996 RS	996	2001	2001	512120
996 SPECIAL USA	996	1999	1999	512120
996 SPS	996	1999	1999	512120
996 USA	996	1999	1999	512120
996	996	1999	1999	512120
996	996	2000	2000	512120
996	996	2001	2001	512120
996 MONSTER S4R / USA / EUROPE	996	2003	2003	512178
996 MONSTER S4R / USA / EUROPE	996	2004	2004	512178
996 S	996	2001	2001	512178
996 SPS II / III	996	1999	1999	512178
996 ST4S / ABS	996	2001	2001	512178
996 ST4S / ABS	996	2002	2002	512178
996 ST4S / ABS	996	2003	2003	512178
998 MATRIX	998	2004	2004	512178
998 MONSTER 4SRS / TRICOLORE EUR/USA	998	2006	2006	512178
998 MONSTER 4SRS / TRICOLORE EUR/USA	998	2007	2007	512178
998 R	998	2002	2002	512178
998 RS	998	2002	2003	512178
998 S BAYLISS / BOSTROM	998	2004	2004	512178
998 S FINAL EDITION	998	2004	2004	512178
998	998	2002	2002	512178
998	998	2003	2003	512178
999 EUR/USA	999	2005	2006	512178
999 R EUR/USA	999	2005	2005	512178
999 R EUR/USA	999	2006	2006	512178
999 R XEROX EUR/USA	999	2006	2006	512178
999 RS	999	2004	2004	512178
999 RS	999	2005	2005	512178
999 S	999	2003	2003	512178
999 S	999	2004	2004	512178
999 S AMA REPLICA USA	999	2007	2007	512178
999 S EUR/USA	999	2005	2006	512178
999	999	2003	2003	512178
999	999	2004	2004	512178
GT EUROPE/USA	1000	2007	2008	512189
GT EUROPE/USA	1000	2009	2010	512189

ATHENA				
Modèle	Cylindre	Année début	Année fin	Réf.
MONSTER S4R S 998 EUROPE / USA	1000	2007	2008	512177
MONSTER S EUR / USA	1000	2004	2004	512178
MONSTER S2R	1000	2006	2007	512178
MONSTER S2R	1000	2008	2008	512178
MONSTER	1000	2003	2003	512178
MONSTER	1000	2004	2004	512178
MULTISTRADA	1000	2003	2003	512180
SPORT TOURING 3S ABS EUROPE / USA	1000	2007	2007	512028
SPORT TOURING 3 EUROPE / USA	1000	2004	2004	512178
SPORT TOURING 3 EUROPE / USA	1000	2005	2007	512178
SPORT CLASSIC EUROPA / USA	1000	2006	2009	512189
SPORT MONOPOSTO JPN	1000	2007	2007	512189
SUPERSPORT EUROPE / USA	1000	2003	2003	512178
SUPERSPORT EUROPE / USA	1000	2004	2004	512178
1098	1098	2007	2008	512189
1098 S	1100	2007	2008	512177
1098 S TRICOLORE	1100	2007	2008	512177
1098 STREETFIGHTER	1100	2010	2012	512177
1098 STREETFIGHTER	1100	2013	2013	512177
1098 STREETFIGHTER S	1100	2010	2012	512177
1098 STREETFIGHTER S	1100	2013	2013	512177
HYPERMOTARD EVO	1100	2010	2012	512044
HYPERMOTARD EVO SP	1100	2010	2010	512044
HYPERMOTARD S	1100	2008	2009	512044
HYPERMOTARD S	1100	2010	2012	512044
HYPERMOTARD EVO	1100	2013	2013	512189
MONSTER S	1100	2009	2009	512177
MONSTER S	1100	2010	2010	512177
MONSTER	1100	2009	2010	512180
MONSTER EVO ABS	1100	2011	2012	512189
MONSTER EVO ABS	1100	2013	2013	512189
MULTISTRADA	1100	2009	2009	512120
MULTISTRADA S	1100	2007	2009	512177
STREETFIGHTER	1100	2009	2012	512189
STREETFIGHTER	1100	2013	2018	512189
1198 S / SP	1198	2009	2011	512177
1198	1198	2009	2011	512189
1199 PANIGALE	1199	2012	2014	512044
1199 PANIGALE R	1199	2013	2014	512177

ATHENA				
Modèle	Cylindre	Année début	Année fin	Réf.
1199 PANIGALE S / TRICOLORE ABS	1199	2013	2014	512177
1098 R / BAYLISS EUR / USA	1200	2008	2009	512177
DIAVEL ABS	1200	2011	2015	512044
DIAVEL ABS	1200	2016	2017	512044
DIAVEL ABS	1200	2018	2019	512044
MONSTER	1200	2014	2014	512176
MONSTER	1200	2015	2017	512176
MONSTER	1200	2018	2018	512176
MONSTER	1200	2019	2019	512176
MULTISTRADA ABS	1200	2012	2014	512044
MULTISTRADA ABS	1200	2015	2015	512044
SUPERBIKE 1299	1285	2015	2015	512044
SUPERBIKE 1299	1285	2016	2017	512044
FANTIC				
HPI	125	1985	1985	512002
GILERA				
FAST BIKE / RRT / ER	125	1987	1987	493905
FAST BIKE / RRT / ER	125	1988	1989	493905
KZ KK / PAIOLI	125	1986	1989	493902
RI S	125	1988	1989	512011
RALLY	125	1987	1988	512011
RTX	125	1986	1987	493905
RV	125	1986	1986	493902
RV	125	1987	1988	493902
RV	125	1989	1990	493902
RV SPORT	125	1984	1985	512038
RX ARIZONA	125	1983	1983	493905
RX ARIZONA	125	1984	1984	493905
RX ARIZONA	125	1985	1985	493905
RX ARIZONA	125	1986	1988	493905
RX ARIZONA	125	1986	1988	493902
RX	125	1986	1986	493902
RX	125	1987	1988	493902
RX	125	1989	1990	493902
TOP RALLY / RC AE	125	1989	1989	480623
XR2 AE	125	1989	1989	512017
ARIZONA	200	1985	1986	493905
ARIZONA	200	1987	1987	493905
RX	200	1983	1983	493905
RX	200	1984	1985	493905
RX	200	1983	1983	512036
RX	200	1984	1985	512036
RC AE	600	1989	1990	480623

MOTEUR

CYCLE

PNEUMATIQUE

ATELIER

ACCESSOIRES

ÉLECTRICITÉ

FILTRATION

FREINAGE

TRANSMISSION

ATHENA				
Modèle	Cylindre	Année début	Année fin	Réf.
HONDA				
CA REBEL	125	1995	1995	480602
CB RR / RS / RT	125	1994	1996	512029
CB RR / RS / RT	125	1994	1996	486028
CBF	125	2009	2009	493904
CBF	125	2010	2011	493904
CBF	125	2012	2013	493904
CBR R	125	2009	2010	486026
CBR R	125	2011	2013	486026
CBR R	125	2014	2017	486026
CM	125	1982	1985	486026
MBX	125	1984	1986	486026
MSX	125	2013	2013	486026
NS F	125	1986	1987	512038
NS F	125	1988	1988	512038
NS F	125	1989	1993	512038
NSR F / R	125	1989	1989	512033
NSR F / R	125	1990	1990	512033
NSR F / R	125	1991	1991	512033
NSR F / R	125	1992	1992	512033
NSR F / R	125	1993	1995	512033
NX	125	1988	1988	493902
NX	125	1989	1989	493902
NX	125	1990	1990	493902
VT C SHADOW	125	1999	1999	493902
VT C SHADOW	125	2000	2007	493902
XL R	125	1982	1982	480602
XL R	125	1985	1985	493902
XL R	125	1986	1986	493902
XL R	125	2001	2010	493902
230 F ENDURO	230	2004	2010	512015
230 F MOTARD	230	2004	2010	512015
230 F TRAIL ID	230	2004	2010	512015
CB	250	1991	1991	486026
CB	250	1992	1992	486026
CB	250	1993	1993	486026
CB	250	1994	1994	486026
CB	250	1995	1995	486026
CB	250	1996	1996	486026
CB	250	1997	1997	486026
CB	250	1998	1998	486026
CB	250	1973	1973	512006
CB	250	1974	1974	512006
CB	250	1975	1976	512006
CB	250	1977	1977	512006

ATHENA				
Modèle	Cylindre	Année début	Année fin	Réf.
CB	250	1978	1978	512006
CB	250	1979	1982	512006
CB RSA / RSC / RSZC	250	1980	1982	480602
CB RSA / RSC / RSZC	250	1983	1983	480602
CBR R / ABS	250	2011	2011	512201
CBR R / ABS	250	2012	2012	512201
CBR R / ABS	250	2013	2013	512201
CBX	250	1984	1986	480602
CMX	250	1985	1987	512006
CMX	250	1988	1992	512006
CMX	250	1993	1995	512006
CMX	250	1996	1996	512006
CMX	250	1997	1997	512006
CMX	250	1998	2011	512006
CMX	250	2012	2013	512006
CMX	250	2014	2015	512006
CMX	250	1996	1996	480602
CRF L	250	2013	2013	512028
CRF L	250	2014	2014	512028
NX DOMINATOR	250	1988	1988	512015
NX DOMINATOR	250	1989	1990	512015
VT	250	1983	1983	493902
VT	250	1984	1986	493902
VTR INTERCEPTOR	250	1988	1990	493902
XL R / RE	250	1984	1984	512008
XL R / RE	250	1985	1985	512008
XL R / RE	250	1986	1986	512008
XL R / RE	250	1986	1986	493902
XL R / RE	250	1987	1987	493902
XL R / RE	250	1990	1990	512015
XR	250	1979	1980	493902
XR R / RF / L / S	250	1981	1982	512015
XR R / RF / L / S	250	1986	1990	512024
XR R / RF / L / S	250	1991	1991	512024
XR R / RF / L / S	250	1992	1992	512024
XR R / RF / L / S	250	1993	1995	512024
XR R / RF / L / S	250	1996	1996	512024
XR R / RF / L / S	250	1997	1998	512024
XR	250	1986	1987	512024
XR	250	1988	1989	512024
XR	250	1990	1991	512024
XR	250	1992	1995	512024
XR	250	1996	1999	512024
XR R / RF / L / S	250	1991	1991	512028
XR R / RF / L / S	250	1992	1992	512028

ATHENA				
Modèle	Cylindre	Année début	Année fin	Réf.
XR R / RF / L / S	250	1993	1995	512028
XR R / RF / L / S	250	1996	1996	512028
XR	250	1984	1985	512028
XR R / RF / L / S	250	1991	1991	512120
XR R / RF / L / S	250	1992	1992	512120
XR R / RF / L / S	250	1993	1995	512120
XR R / RF / L / S	250	1996	1996	512120
XR	250	1984	1985	512120
CB F	300	2015	2016	512201
CB F	300	2017	2018	512201
CB R R / RA	300	2015	2016	512201
CB R R / RA	300	2017	2017	512201
CB R R / RA	300	2018	2019	512201
CB SG / T / SJ	350	1986	1988	493902
CB F / F1 / F2	400	1989	1990	512026
CB F / F1 / F2	400	1989	1990	512191
CB R F	400	1989	1990	512026
NS R	400	1985	1987	512015
NS R	400	1988	1988	512015
VF	400	1983	1983	493902
VF	400	1984	1984	493902
VF	400	1985	1986	493902
VFR R	400	1990	1992	512026
CB SC / T	450	1982	1986	512006
CB DX	450	1989	1992	480602
CMX C REBEL	450	1986	1987	512015
CB F / X - M.Y.2013	500	2013	2017	512026
CB F / X - M.Y.2013	500	2018	2019	512026
CB F / X - M.Y.2013	500	2013	2017	512192
CB F / X - M.Y.2013	500	2018	2019	512192
CB R TWIN	500	1994	1994	512015
CB R - M.Y.2013	500	2013	2017	512026
CX TURBO	500	1982	1982	512015
CX TURBO	500	1983	1983	512015
CX TURBO	500	1984	1984	512015
GB	500	1989	1990	493902
XBR F	500	1985	1987	493902
XBR F	500	1988	1988	493902
XBR F	500	1989	1989	493902
XBR F	500	1990	1991	493902
XL R	500	1982	1982	512015
XL R	500	1983	1984	512015
CBX	550	1982	1984	493902
CB HORNET F / S F2	600	1998	2001	512026
CB HORNET F / S F2	600	2002	2002	512026

ATHENA				
Modèle	Cylindre	Année début	Année fin	Réf.
CB HORNET F / S F2	600	2003	2003	512026
CB HORNET F / S F2	600	2004	2004	512026
CB HORNET F / S F2	600	2005	2006	512026
CB HORNET F / S F2	600	2007	2009	512026
CB HORNET F / S F2	600	2010	2011	512026
CB HORNET F / S F2	600	2012	2012	512026
CB HORNET F / S F2	600	2013	2013	512026
CB HORNET F / S F2	600	2004	2004	512191
CB HORNET F / S F2	600	2005	2006	512192
CB HORNET F / S F2	600	2007	2009	512192
CB HORNET F / S F2	600	2010	2011	512192
CB HORNET F / S F2	600	2012	2012	512192
CB HORNET F / S F2	600	2013	2013	512192
CB F	600	2004	2006	512026
CB F	600	2007	2007	512026
CB F	600	2008	2010	512026
CB R F	600	1987	1990	512015
CB R F	600	1991	1993	512026
CB R F	600	1994	1994	512026
CB R F	600	1995	1998	512026
CB R F599	600	2004	2004	512026
CB R RR	600	2005	2006	512026
CB R RR	600	2009	2010	512026
CB R RR	600	2011	2013	512026
CB R RR	600	2014	2015	512026
CB R F	600	1999	1999	512028
CB R F	600	1999	1999	512120
CB R F4 SPORT	600	2003	2003	512180
CB R F4 SPORT	600	2004	2004	512180
CB R F4 SPORT	600	2005	2006	512180
CB R RR	600	2003	2004	512185
CB R F	600	1991	1993	512191
CB R F	600	1994	1994	512191
CB R F	600	1995	1998	512191
CB R F599	600	1991	2000	512191
CB R F	600	2011	2011	512192
CB R F	600	2012	2012	512192
CB R F	600	2013	2018	512192
CB R RR	600	2005	2006	512192
CB R RR	600	2009	2010	512192
CB R RR	600	2011	2013	512192
CB R RR	600	2014	2015	512192
CB R RR	600	2016	2016	512192
NTV	600	1988	1988	512026
NTV	600	1989	1991	512026

MOTEUR

CYCLE

PNEUMATIQUE

ATELIER

ACCESSOIRES

ÉLECTRICITÉ

FILTRATION

FREINAGE

TRANSMISSION

ATHENA				
Modèle	Cylindre	Année début	Année fin	Réf.
NTV	600	1992	1992	512026
VT C / CD SHADOW	600	1988	1993	512020
VT C / CD SHADOW	600	1994	1994	512020
VT C / CD SHADOW	600	1995	1997	512020
VT C / CD SHADOW	600	1998	1998	512020
VT XC SHADOW	600	1999	1999	512020
VT XC SHADOW	600	2000	2018	512020
VT C SHADOW VLX	600	2003	2006	512184
VT VLX DELUXE	600	2003	2006	512184
XL R	600	1983	1986	512021
XL R	600	1987	1987	512021
XL V TRANSALP	600	1987	1988	512026
XL V TRANSALP	600	1989	1989	512026
XL V TRANSALP	600	1990	1990	512026
XL V TRANSALP	600	1991	1993	512026
XL V TRANSALP	600	1994	1994	512026
XL LM F / G / H	600	1985	1985	512026
XL LM F / G / H	600	1986	1987	512026
XL R	600	1987	1987	512026
CB F - M.Y.2014	650	2014	2015	512026
CB F - M.Y.2014	650	2014	2015	512192
CB F - M.Y.2014	650	2016	2017	512192
CB F - M.Y.2014	650	2018	2018	512192
CBR F/FA/FE	650	2014	2015	512026
CBR F/FA/FE	650	2014	2015	512192
CBR F/FA/FE	650	2016	2016	512192
CBX	650	1983	1983	512021
NT HAWK GT	650	1988	1991	512026
NTV	650	1988	1989	512026
NTV	650	1990	1990	512026
NTV	650	1991	1993	512026
NTV	650	1994	1994	512026
NTV	650	1995	1995	512026
NX DOMINATOR	650	1988	1989	512026
NX DOMINATOR	650	1990	1992	512026
NX DOMINATOR	650	1993	1995	512026
NX DOMINATOR	650	1996	1996	512026
NX DOMINATOR	650	1997	1999	512026
NX DOMINATOR	650	2002	2002	512026
XL V TRANSALP	650	2000	2000	512026
XL V TRANSALP	650	2001	2003	512026
XL V TRANSALP	650	2004	2006	512026
XR C / L	650	1993	1993	512028
XR C / L	650	1994	1998	512028
XR C / L	650	1999	2003	512028

ATHENA				
Modèle	Cylindre	Année début	Année fin	Réf.
XR C / L	650	2004	2004	512028
XR C / L	650	2005	2007	512028
XR C / L	650	2008	2019	512028
XR C / L	650	1993	1993	512120
XR C / L	650	1994	1998	512120
XR C / L	650	1999	2003	512120
XR C / L	650	2004	2004	512120
XR C / L	650	2005	2007	512120
XR C / L	650	2008	2019	512120
XR R	650	2000	2000	512130
XR R	650	2001	2005	512130
XR R	650	2006	2006	512130
XR R	650	2007	2007	512130
XR R	650	2008	2008	512130
XR650L	650	1993	2009	512028
XR650L	650	2010	2012	512028
XR650L	650	2013	2015	512028
XR650L	650	2016	2019	512028
XRV AFRICA TWIN	650	1988	1988	512028
XRV AFRICA TWIN	650	1989	1989	512028
XRV AFRICA TWIN	650	1988	1988	512120
XRV AFRICA TWIN	650	1989	1989	512120
CTX	700	2014	2015	512026
CTX	700	2016	2017	512026
CTX	700	2014	2015	512192
NT V DEAUVILLE / ABS	700	2006	2006	512026
NT V DEAUVILLE / ABS	700	2007	2007	512026
NT V DEAUVILLE / ABS	700	2008	2008	512026
NT V DEAUVILLE / ABS	700	2010	2010	512026
NT V DEAUVILLE / ABS	700	2011	2011	512026
NT V DEAUVILLE / ABS	700	2006	2006	512192
NT V DEAUVILLE / ABS	700	2007	2007	512192
NT V DEAUVILLE / ABS	700	2008	2008	512192
NT V DEAUVILLE / ABS	700	2009	2009	512192
NT V DEAUVILLE / ABS	700	2010	2010	512192
NT V DEAUVILLE / ABS	700	2011	2011	512192
VF F INTERCEPTOR	700	1984	1985	512021
VFR F	700	1986	1987	512015
VT C SHADOW	700	1984	1986	512021
VT C SHADOW	700	1987	1987	512021
XL V TRANSALP	700	2008	2010	512026
XL V TRANSALP	700	2011	2011	512026
XL V TRANSALP	700	2008	2010	512192
XL V TRANSALP	700	2011	2011	512192
CB A AUTOMATIC	750	1975	1975	493902

ATHENA				
Modèle	Cylindre	Année début	Année fin	Réf.
CB A AUTOMATIC	750	1976	1978	493902
CB A AUTOMATIC	750	1979	1980	493902
CB SEVEN FIFTY / NIGHTHAWK	750	1969	1970	493902
CB SEVEN FIFTY / NIGHTHAWK	750	1971	1972	493902
CB SEVEN FIFTY / NIGHTHAWK	750	1982	1984	493902
CB K	750	1972	1976	512015
CB K	750	1977	1978	512015
CB K	750	1979	1979	512015
CB K	750	1980	1980	512015
CB K	750	1981	1982	512015
CB C / SC NIGHTHAWK	750	2003	2003	512026
CB SEVEN FIFTY / NIGHTHAWK	750	1991	1991	512026
CB SEVEN FIFTY / NIGHTHAWK	750	1992	1992	512026
CB SEVEN FIFTY / NIGHTHAWK	750	1993	1998	512026
CB A AUTOMATIC	750	1969	1970	512134
CB C / SC NIGHTHAWK	750	1969	1970	512134
CB K	750	1969	1969	512134
CB K	750	1970	1970	512134
CB SEVEN FIFTY / NIGHTHAWK	750	1969	1970	512134
CB K	750	1991	2003	512191
CB SEVEN FIFTY / NIGHTHAWK	750	1991	1991	512191
CB SEVEN FIFTY / NIGHTHAWK	750	1992	1992	512191
CB SEVEN FIFTY / NIGHTHAWK	750	1993	1998	512191
CB SEVEN FIFTY / NIGHTHAWK	750	1999	2002	512191
CB SEVEN FIFTY / NIGHTHAWK	750	2003	2003	512191
CBX	750	1984	1986	512021
NC S/X - M.Y.2014	750	2014	2014	512026
NC S/X - M.Y.2014	750	2014	2014	512192
NC S/X - M.Y.2014	750	2015	2017	512192
NC S/X - M.Y.2014	750	2018	2019	512192
RVF R / RR (RC-45)	750	1994	1994	512026
RVF R / RR (RC-45)	750	1995	1995	512026
VF C / CD MAGNA / DELUXE	750	1982	1982	512015
VF C / CD MAGNA / DELUXE	750	1983	1983	512015
VF C / CD MAGNA / DELUXE	750	1983	1983	512021

ATHENA				
Modèle	Cylindre	Année début	Année fin	Réf.
VF C / CD MAGNA / DELUXE	750	1984	1984	512021
VF C / CD MAGNA / DELUXE	750	1987	1987	512021
VF C / CD MAGNA / DELUXE	750	1988	1988	512021
VF F	750	1987	1988	512021
VF C / CD MAGNA / DELUXE	750	1994	1998	512026
VF C / C2 / CD V45 MAGNA	750	1997	2003	512026
VFR F	750	1986	1986	512015
VFR F	750	1987	1987	512015
VFR F	750	1988	1989	512026
VFR F	750	1990	1993	512026
VFR F	750	1994	1996	512026
VFR R	750	1988	1989	512028
VFR R	750	1990	1990	512028
VFR R	750	1991	1992	512028
VFR R	750	1988	1989	512120
VFR R	750	1990	1990	512120
VFR R	750	1991	1992	512120
VT SHADOW	750	1983	1983	512021
VT SHADOW	750	1984	1985	512021
VT SHADOW	750	1986	1987	512021
VT C MAGNA	750	2003	2003	512026
VT CD SHADOW ACE DXL	750	2003	2003	512026
VT DCA SHADOW SPIRIT	750	2003	2006	512026
VT DCB SHADOW SPIRIT	750	2003	2006	512026
VT C SHADOW AERO	750	2004	2015	512174
VT C SHADOW AERO	750	2016	2017	512174
VT C SHADOW AERO	750	2018	2019	512174
VT CA SHADOW AERO	750	2004	2007	512174
VT CA SHADOW AERO	750	2008	2015	512174
VT CA SHADOW AERO	750	2016	2017	512174
VT C MAGNA	750	1994	1997	512191
VT C MAGNA	750	1998	2002	512191
VT C MAGNA	750	2003	2003	512191
VT CD SHADOW ACE DXL	750	1995	1999	512191
VT DCA SHADOW SPIRIT	750	2001	2002	512191
VT DCA SHADOW SPIRIT	750	2003	2006	512191
VT DCA SHADOW SPIRIT	750	2007	2007	512191
XRV AFRICA TWIN	750	1990	1991	512028
XRV AFRICA TWIN	750	1992	1992	512028
XRV AFRICA TWIN	750	1993	1993	512028
XRV AFRICA TWIN	750	1994	2000	512028
XRV AFRICA TWIN	750	1990	1991	512120

MOTEUR

CYCLE

PNEUMATIQUE

ATELIER

ACCESSOIRES

ÉLECTRICITÉ

FILTRATION

FREINAGE

TRANSMISSION

ATHENA				
Modèle	Cylindre	Année début	Année fin	Réf.
XRV AFRICA TWIN	750	1992	1992	512120
XRV AFRICA TWIN	750	1993	1993	512120
XRV AFRICA TWIN	750	1994	2000	512120
- VFRXB / VFRXC CROSSRUNNER	800	2012	2012	512180
PC PACIFIC COAST	800	1994	1997	512026
PC PACIFIC COAST	800	1998	1998	512026
VFR FI 98-01	800	1998	1999	512026
VFR FI 98-01	800	2000	2001	512026
VFR V-TEC 02-09	800	2002	2002	512180
VFR V-TEC 02-09	800	2003	2005	512180
VFR V-TEC 02-09	800	2006	2006	512180
VFR V-TEC 02-09	800	2007	2009	512180
VT C SHADOW	800	1988	1988	512021
CB C / F	900	1979	1979	493902
CB C / F	900	1980	1980	493902
CB C / F	900	1981	1981	512015
CB C / F	900	1982	1982	512021
CB C / F	900	1983	1983	512021
CB C / F	900	2002	2007	512180
CB F	900	2002	2006	512180
CB F	900	2007	2007	512180
CBR R / RR	900	1992	1992	512031
CBR R / RR	900	1993	1995	512031
CBR R / RR	900	1996	1997	512031
CBR R / RR	900	1998	1998	512031
CBR R / RR	900	1992	1992	512050
CBR R / RR	900	1993	1995	512050
CBR R / RR	900	1996	1997	512050
CBR R / RR	900	1998	1998	512050
CBR R / RR	900	1993	1995	512121
CBR R / RR	900	1996	1997	512121
CBR R / RR	900	1998	1998	512121
CBR R / RR	900	1999	1999	512121
CBR 954 RR	900	2003	2003	512180
CB SF	1000	1983	1983	512021
CB SF	1000	1993	1993	512026
CB R	1000	2008	2017	512028
CB R	1000	2018	2019	512028
CB SF	1000	1993	1993	512028
CB SF	1000	1994	1995	512028
CB SF	1000	1996	1997	512028
CB SF	1000	1993	1993	512120
CB SF	1000	1994	1995	512120
CB SF	1000	1996	1997	512120

ATHENA				
Modèle	Cylindre	Année début	Année fin	Réf.
CBF	1000	2006	2009	512026
CBF	1000	2010	2010	512026
CBF	1000	2011	2011	512026
CBF	1000	2012	2016	512026
CBR F / FP - M.Y.1988	1000	1987	1988	512026
CBR F / FP - M.Y.1988	1000	1989	1989	512026
CBR F / FP - M.Y.1988	1000	1990	1992	512026
CBR F / FP - M.Y.1988	1000	1993	1996	512026
CBR RR - M.Y.2004	1000	2005	2005	512028
CBR RR - M.Y.2004	1000	2006	2013	512028
CBR RR - M.Y.2006	1000	2006	2007	512028
CBR RR - M.Y.2008	1000	2008	2015	512028
CBR RR - M.Y.2008	1000	2016	2019	512028
CBR F / FP - M.Y.1988	1000	1987	1988	512191
CBR F / FP - M.Y.1988	1000	1989	1989	512191
CBR F / FP - M.Y.1988	1000	1990	1992	512191
CBR F / FP - M.Y.1988	1000	1993	1996	512191
CBX	1000	1979	1980	493902
CBX	1000	1981	1982	512021
RVT R (RC51)	1000	2003	2005	512180
VF R	1000	1984	1984	512026
VF R	1000	1985	1986	512026
VF	1000	1984	1985	512026
VF	1000	1986	1986	512026
XL VARADERO	1000	1999	2002	512028
XL VARADERO	1000	2003	2006	512028
XL VARADERO	1000	2007	2010	512028
XL VARADERO	1000	2011	2011	512028
CB	1100	2010	2012	512026
CB	1100	2013	2016	512026
CB	1100	2010	2012	512192
CB	1100	2013	2016	512192
CBR XX THUNDERBIRD	1100	1997	1998	512028
CBR XX THUNDERBIRD	1100	1999	1999	512028
CBR XX THUNDERBIRD	1100	2000	2002	512028
CBR XX THUNDERBIRD	1100	2003	2003	512028
CBR XX THUNDERBIRD	1100	1997	1998	512120
CBR XX THUNDERBIRD	1100	1999	1999	512120
CBR XX THUNDERBIRD	1100	2000	2002	512120
CBR XX THUNDERBIRD	1100	2003	2003	512120
CBR XX THUNDERBIRD	1100	1997	1998	512122
GL	1100	1980	1980	512021
GL	1100	1981	1983	512021
ST	1100	1990	1990	512026
ST	1100	1991	1994	512026

ATHENA				
Modèle	Cylindre	Année début	Année fin	Réf.
ST	1100	1995	1996	512026
ST	1100	1997	1998	512026
VF F	1100	1983	1984	512026
VF F	1100	1985	1986	512026
VT CR	1100	1994	1994	512026
VT SHADOW ACE	1100	1985	1986	512026
VT SHADOW ACE	1100	1987	1988	512026
VT SHADOW ACE	1100	1989	1992	512026
VT SHADOW ACE	1100	1993	1993	512026
VT SHADOW ACE	1100	1994	1994	512026
VT SHADOW ACE	1100	1995	1996	512026
VT SHADOW ACE	1100	1997	1997	512026
VT SHADOW ACE	1100	1998	1998	512026
VT C1 SHADOW/SPIRIT	1100	2003	2006	512026
VT CS	1100	1995	1995	512026
VT C2 SHADOW SABRE	1100	2003	2006	512187
VT C1 SHADOW/SPIRIT	1100	1985	1988	512191
VT C1 SHADOW/SPIRIT	1100	1989	2002	512191
VT C1 SHADOW/SPIRIT	1100	2003	2006	512191
VT C1 SHADOW/SPIRIT	1100	2007	2007	512191
GL GOLDWING / INTERSTATE	1200	1984	1984	512026
GL GOLDWING / INTERSTATE	1200	1985	1985	512026
GL GOLDWING / INTERSTATE	1200	1986	1986	512026
GL GOLDWING / INTERSTATE	1200	1987	1987	512026
GL GOLDWING / INTERSTATE	1200	1988	1988	512026
GL GOLDWING / INTERSTATE	1200	1984	1984	512191
GL GOLDWING / INTERSTATE	1200	1985	1985	512191
GL GOLDWING / INTERSTATE	1200	1986	1986	512191
GL GOLDWING / INTERSTATE	1200	1987	1987	512191
VFR F	1200	2010	2016	512176
VFR1200XC VFRXDC CROSSTOURER	1200	2012	2012	512176
VFR1200XC VFRXDC CROSSTOURER	1200	2013	2018	512176
CB F-3	1300	2010	2010	512028
ST PAN EUROPEAN / ABS	1300	2003	2005	512185
ST	1300	2003	2010	512185
ST	1300	2011	2011	512185
ST	1300	2012	2013	512185
ST	1300	2014	2015	512185

ATHENA				
Modèle	Cylindre	Année début	Année fin	Réf.
VT CR/CT/CRA	1300	2010	2010	512026
VT CR/CT/CRA	1300	2011	2019	512026
VT	1300	2010	2012	512192
VT	1300	2013	2016	512192
VTX C	1300	2004	2004	512026
VTX C	1300	2005	2006	512026
VTX R / RETRO	1300	2004	2004	512026
VTX R / RETRO	1300	2005	2006	512026
VTX S	1300	2003	2003	512026
VTX S	1300	2004	2006	512026
VTX	1300	2003	2003	512026
VTX	1300	2004	2006	512026
VTX C	1300	2004	2004	512191
VTX C	1300	2005	2006	512191
VTX C	1300	2007	2007	512191
VTX R / RETRO	1300	2005	2006	512191
VTX R / RETRO	1300	2007	2007	512191
VTX S	1300	2003	2003	512191
VTX S	1300	2004	2006	512191
VTX S	1300	2007	2007	512191
GL A / I / SE	1500	1988	1989	512026
GL A / I / SE	1500	1990	1992	512026
GL A / I / SE	1500	1993	1993	512026
GL A / I / SE	1500	1994	1994	512026
GL A / I / SE	1500	1995	1995	512026
GL A / I / SE	1500	1996	1996	512026
GL A / I / SE	1500	1997	1998	512026
GL A / I / SE	1500	1999	2000	512026
GL C/CT VALKYRIE / ASPENCADE	1500	2003	2003	512031
GL CD VALKYRIE	1500	2003	2003	512031
GL CD VALKYRIE DELUXE	1500	2003	2003	512031
GL GOLD WING	1500	1997	1998	512031
GL GOLD WING	1500	1999	1999	512031
GL GOLD WING	1500	1997	1998	512050
GL GOLD WING	1500	1999	1999	512050
GL A / I / SE	1500	1997	1998	512121
GL A / I / SE	1500	1999	2000	512121
GL A / I / SE	1500	2001	2001	512121
GL A / I / SE	1500	2002	2003	512121
GL A / I / SE	1500	1988	1989	512191
GL A / I / SE	1500	1990	1992	512191
GL A / I / SE	1500	1993	1993	512191
GL A / I / SE	1500	1994	1994	512191
GL A / I / SE	1500	1995	1995	512191

MOTEUR

CYCLE

PNEUMATIQUE

ATELIER

ACCESSOIRES

ÉLECTRICITÉ

FILTRATION

FREINAGE

TRANSMISSION

ATHENA				
Modèle	Cylindre	Année début	Année fin	Réf.
GL GOLD WING	1800	2003	2011	512185
VTX C / S (RETRO)	1800	2003	2004	512185
VTX R RETRO	1800	2003	2003	512185
VTX S RETRO SPK WHL	1800	2003	2003	512185
HUSQVARNA				
WRE	125	2000	2010	480623
WRE	125	2011	2011	480623
WRE	125	2012	2012	480623
WRE	125	1995	1995	512028
WRE	125	1995	1995	512040
WRE	125	1996	1996	512040
WRE	125	1998	1999	512047
WRE	125	1995	1995	512120
KAWASAKI				
AR	125	1982	1987	493904
AR	125	1988	1991	493904
AR	125	1992	1993	493904
AR	125	1994	1994	493904
KD	125	1975	1979	512001
KDX A1 / B1 / A2 / B2	125	1981	1982	480603
KDX A1 / B1 / A2 / B2	125	1990	1990	512026
KDX A1 / B1 / A2 / B2	125	1991	1993	512026
KE A2 / A10	125	1982	1983	486026
KE A2 / A10	125	1984	1985	486026
KE A2 / A10	125	1986	1987	486026
KE A2 / A10	125	1976	1979	512001
KE A2 / A10	125	1980	1981	512001
KLX CAF	125	2008	2009	480602
KLX CAF	125	2010	2010	480602
KLX CAF	125	2010	2010	493902
KLX CAF	125	2011	2011	493902
KLX D-TRACKER	125	2010	2011	493902
KLX D-TRACKER	125	2012	2013	493902
KD	175	1976	1979	512004
KE E	175	1976	1978	512004
KE E	175	1979	1979	493902
KE E	175	1980	1983	493902
KDX A	220	1997	2001	512029
KDX A	220	1997	2001	486028
EL B / E	250	1988	1988	512011
EL B / E	250	1989	1989	512011
EL B / E	250	1990	1990	512011
EL B / E	250	1991	1991	512011
EL B / E	250	1992	1992	512011
EL B / E	250	1993	1994	512011

ATHENA				
Modèle	Cylindre	Année début	Année fin	Réf.
EL F2/F5	250	1996	1998	512011
ER SCORPION	250	1983	1987	486026
ER SCORPION	250	1988	1988	486026
ER SCORPION	250	1989	1990	486026
EX E / F	250	1988	1989	493902
EX F	250	1988	1990	512011
EX F	250	1991	1998	512011
EX	250	1990	1992	512014
GPX	250	1988	1988	493902
GPX	250	1989	1994	493902
KE A / B	250	1977	1979	512008
KL	250	1978	1979	512008
KL	250	1980	1981	480603
KL	250	1982	1982	480603
KL	250	1983	1984	480603
KL	250	1985	1986	480603
KL	250	1987	1996	480603
KLR	250	1985	1994	480603
KLX S	250	2007	2008	512029
KLX S	250	2009	2009	512029
KLX S	250	2010	2010	512029
KLX S	250	2011	2012	512029
KLX S	250	2007	2008	512125
KLX S	250	2009	2009	512125
KLX S	250	2010	2010	512125
KLX S	250	2011	2012	512125
KR	250	1989	1993	512024
NINJA R - M.Y.2008	250	2008	2012	512015
Z C1 / C2 / G1 / G2	250	1981	1981	512003
Z C1 / C2 / G1 / G2	250	1982	1982	512003
Z C1 / C2 / G1 / G2	250	1983	1983	512003
ZX F	250	1988	1994	493902
ZZR	250	1986	1987	493902
ZZR	250	1988	1991	512011
ZZR	250	1992	1998	512011
ZZR	250	1999	2007	512011
ZZ-R	250	1990	1990	486026
ZZ-R	250	1991	1993	486026
ZZ-R	250	1996	1998	512014
KLE VERSYS	300	2017	2017	512026
KLE VERSYS	300	2018	2019	512026
KLE VERSYS	300	2017	2017	512192
NINJA R / ABS - M.Y.2013	300	2013	2013	512201
NINJA R / ABS - M.Y.2013	300	2014	2014	512201
NINJA R / ABS - M.Y.2013	300	2015	2015	512201

ATHENA				
Modèle	Cylindre	Année début	Année fin	Réf.
NINJA R / ABS - M.Y.2013	300	2016	2017	512201
Z300 ABS	300	2015	2015	512201
EX B1	305	1983	1983	486026
EX B1	305	1984	1993	486026
GPZ UNI-TRAK / BELT-DRIVE	305	1983	1983	486026
GPZ UNI-TRAK / BELT-DRIVE	305	1984	1984	486026
GPZ UNI-TRAK / BELT-DRIVE	305	1985	1994	486026
GPZ UNI-TRAK / BELT-DRIVE	305	1983	1983	512003
GPZ UNI-TRAK / BELT-DRIVE	305	1984	1984	512003
GPZ	400	1983	1984	493902
GPZ	400	1985	1985	493902
KDX A1 / A2	400	1979	1980	512017
Z B1 / B2 / G1 CUSTOM	400	1974	1977	512006
Z B1 / B2 / G1 CUSTOM	400	1978	1978	512006
Z B1 / B2 / G1 CUSTOM	400	1979	1979	512006
Z B1 / B2 / G1 CUSTOM	400	1980	1980	512006
Z B1 / B2 / G1 CUSTOM	400	1981	1982	512006
Z B1 / B2 / G1 CUSTOM	400	1984	1984	493902
ZR A1	400	1983	1983	493902
ZR A1	400	1984	1984	493902
ZR A1	400	1985	1985	493902
ZX-4	400	1985	1985	493902
ZX-4	400	1986	1986	493902
ZX-4	400	1987	1987	493902
ZX-4	400	1991	1994	512026
ZXR H2 / L1 / L9	400	1991	1999	512026
KDX B1	420	1981	1981	512017
EN	450	1985	1985	493902
EN	450	1986	1990	493902
KDX A1	450	1982	1982	512017
EN A/B/C VULCAN LTD	500	1996	1999	480624
EN A/B/C VULCAN LTD	500	2000	2002	480624
EN	500	1994	1998	480624
EN	500	1999	1999	480624
EN	500	2000	2000	480624
EN	500	2001	2002	480624
EN A/B/C VULCAN LTD	500	2003	2003	512187
ER-5	500	1997	2000	512015
ER-5	500	2001	2001	512015
ER-5	500	2002	2004	512015
ER-5	500	2005	2005	512015
GPZ	500	1987	1987	493902

ATHENA				
Modèle	Cylindre	Année début	Année fin	Réf.
GPZ	500	1988	1988	493902
GPZ	500	1989	1992	493902
GPZ	500	1993	1993	493902
GPZ EX	500	1987	1989	493902
GPZ EX	500	1990	1991	493902
GPZ EX	500	1992	1993	493902
GPZ S A1-A4	500	1987	1989	493902
GPZ S A1-A4	500	1990	1993	493902
GPZ	500	1994	1994	512015
GPZ	500	1995	1995	512015
GPZ	500	1996	1996	512015
GPZ	500	1997	1998	512015
GPZ	500	1999	1999	512015
GPZ EX	500	1994	1995	512015
GPZ EX	500	1996	1997	512015
GPZ EX	500	1998	1998	512015
GPZ EX	500	1999	2003	512015
GPZ EX	500	2004	2005	512015
GPZ EX	500	2006	2006	512015
GPZ EX	500	2007	2007	512015
GPZ S A1-A4	500	1994	1995	512015
GPZ S A1-A4	500	1996	2001	512015
GPZ S A1-A4	500	2002	2002	512015
GPZ S A1-A4	500	2003	2003	512015
KLE A / A1 / A9	500	1991	1991	512024
KLE A / A1 / A9	500	1992	1999	512024
KLE A / A1 / A9	500	2000	2000	512024
KLE A / A1 / A9	500	2001	2002	512024
GPZ	550	1982	1983	493902
GPZ	550	1981	1981	512011
GPZ	550	1984	1984	512011
GPZ	550	1985	1987	512011
GT	550	1983	1984	512010
GT	550	1985	1985	512010
GT	550	1986	1991	512010
GT	550	1992	1994	512010
GT	550	1983	1984	512051
GT	550	1985	1985	512051
GT	550	1986	1991	512051
GT	550	1992	1994	512051
Z	550	1983	1983	493902
Z	550	1984	1984	493902
Z	550	1983	1983	512010
Z	550	1984	1984	512010
Z	550	1985	1993	512010

MOTEUR

CYCLE

PNEUMATIQUE

ATELIER

ACCESSOIRES

ÉLECTRICITÉ

FILTRATION

FREINAGE

TRANSMISSION

ATHENA				
Modèle	Cylindre	Année début	Année fin	Réf.
Z	550	1994	1994	512010
Z	550	1980	1980	512011
Z	550	1981	1982	512011
Z	550	1983	1983	512011
Z	550	1984	1984	512011
Z	550	1983	1983	512051
Z	550	1984	1984	512051
Z	550	1985	1993	512051
Z	550	1994	1994	512051
ZR	550	1983	1983	493902
ZR	550	1984	1984	493902
ZR	550	1985	1988	493902
ZR	550	1990	1990	512020
ZR	550	1991	1991	512020
ZR	550	1991	1991	512021
ZR	550	1992	1992	512021
ZR	550	1993	1993	512021
ZR	550	1994	1994	512021
ZX A1/ A3 GPZ	550	1983	1983	493902
ZX A1/ A3 GPZ	550	1984	1984	493902
ZX A1/ A3 GPZ	550	1985	1986	493902
ZX A1/ A3 GPZ	550	1987	1988	493902
ZX A1/ A3 GPZ	550	1989	1991	493902
GPX R/ C	600	1988	1988	512016
GPX R/ C	600	1989	1993	512016
GPX R/ C	600	1994	1994	512016
GPZ R	600	1985	1985	512014
GPZ R	600	1986	1989	512014
GPZ600R GPX	600	1985	1987	512014
GPZ600R GPX	600	1988	1988	512016
GPZ600R GPX	600	1989	1989	512016
GPZ600R GPX	600	1990	1992	512016
GPZ600R GPX	600	1993	1993	512016
GPZ600R GPX	600	1994	1994	512016
GPZ600R GPX	600	1998	2001	512135
KL A1/ B1/ B5 R	600	1984	1986	512017
KL A1/ B1/ B5 R	600	1987	1988	512017
KL A1/ B1/ B5 R	600	1989	1990	512017
KL A1/ B1/ B5 R	600	1991	1991	512017
KLR	600	1984	1986	512017
KLR	600	1987	1990	512017
KLR	600	1991	1994	512017
NINJA ZX-6R	600	1988	1989	512016
NINJA ZX-6R	600	1990	1992	512016
NINJA ZX-6R	600	1993	1993	512016

ATHENA				
Modèle	Cylindre	Année début	Année fin	Réf.
NINJA ZX-6R	600	1994	1994	512016
NINJA ZX-6R	600	1995	1997	512016
NINJA ZX-6R	600	1995	1997	512024
NINJA ZX-6R	600	2005	2005	512026
NINJA ZX-6R	600	2006	2006	512026
NINJA ZX-6R	600	2007	2008	512026
NINJA ZX-6R	600	2009	2012	512026
NINJA ZX-6R	600	2013	2014	512026
NINJA ZX-6R	600	2015	2015	512026
NINJA ZX-6RR	600	2005	2005	512026
NINJA ZX-6R	600	1998	1999	512130
NINJA ZX-6R	600	1998	1999	512135
NINJA ZX-6R	600	2000	2000	512135
NINJA ZX-6R	600	2001	2001	512135
NINJA ZX-6R	600	2002	2002	512135
NINJA ZX-6R	600	2003	2004	512174
NINJA ZX-6RR	600	2003	2003	512174
NINJA ZX-6RR	600	2004	2004	512174
NINJA ZX-6R	600	2007	2008	512192
NINJA ZX-6R	600	2009	2012	512192
NINJA ZX-6R	600	2013	2014	512192
NINJA ZX-6R	600	2015	2015	512192
NINJA ZX-6R	600	2016	2016	512192
NINJA ZX-6R	600	2017	2017	512192
NINJA ZX-6RR	600	2005	2005	512192
NINJA ZX-6RR	600	2006	2006	512192
ZL A/ B ELIMINATOR	600	1986	1987	512014
ZL A/ B ELIMINATOR	600	1995	1997	512014
ZZ-R	600	1990	1992	512026
ZZ-R	600	1993	1996	512026
ZZ-R	600	1997	1999	512026
ZZ-R	600	2000	2001	512026
ZZ-R	600	2002	2005	512026
ZZ-R	600	2006	2006	512026
NINJA ZX-6R	636	2005	2006	512026
NINJA ZX-6R	636	2007	2007	512026
NINJA ZX-6R	636	2013	2016	512026
NINJA ZX-6R	636	2017	2017	512026
NINJA ZX-6R	636	2018	2018	512026
NINJA ZX-6R	636	2019	2019	512026
NINJA ZX-6R	636	2002	2002	512135
NINJA ZX-6R	636	2003	2004	512174
NINJA ZX-6R	636	2013	2016	512192
NINJA ZX-6R	636	2017	2017	512192
ER-6F ABS	650	2006	2008	512187

ATHENA				
Modèle	Cylindre	Année début	Année fin	Réf.
ER-6F ABS	650	2009	2011	512187
ER-6F ABS	650	2012	2015	512187
ER-6F ABS	650	2016	2016	512187
ER-6N ABS	650	2006	2008	512187
ER-6N ABS	650	2009	2011	512187
ER-6N ABS	650	2012	2012	512187
ER-6N ABS	650	2013	2015	512187
ER-6N ABS	650	2016	2016	512187
KL A1/ A12	650	1987	1991	512017
KL A1/ A12	650	1992	1995	512017
KL A1/ A12	650	1996	1996	512017
KLE VERSYS	650	2007	2009	512026
KLE VERSYS	650	2010	2010	512026
KLE VERSYS	650	2011	2012	512026
KLE VERSYS	650	2013	2014	512026
KLE VERSYS	650	2015	2017	512026
KLE VERSYS	650	2018	2019	512026
KLE VERSYS	650	2020	2020	512026
KLE VERSYS	650	2007	2009	512192
KLE VERSYS	650	2010	2010	512192
KLE VERSYS	650	2011	2012	512192
KLE VERSYS	650	2013	2014	512192
KLE VERSYS	650	2015	2017	512192
KLR TENGAI	650	1987	1989	512017
KLR CI-C10	650	1987	1988	512024
KLR CI-C10	650	1989	1992	512024
KLR CI-C10	650	1993	1994	512024
KLR CI-C10	650	1995	1996	512024
KLR CI-C10	650	1997	2005	512024
KLR CI-C10	650	2006	2007	512024
KLR CI-C10	650	2008	2009	512024
KLR TENGAI	650	1995	1997	512024
KLR TENGAI	650	1998	1998	512024
KLR TENGAI	650	1999	1999	512024
KLR TENGAI	650	2000	2004	512024
KLR	650	2008	2008	480624
KLR	650	2009	2009	480624
KLR	650	2010	2010	480624
KLR	650	2011	2012	480624
KLX	650	1993	1995	512029
KLX	650	1996	1996	512029
KLX	650	1997	1998	512029
KLX	650	1999	1999	512029
KLX	650	2000	2000	512029
KLX	650	2001	2001	512029

ATHENA				
Modèle	Cylindre	Année début	Année fin	Réf.
KLX	650	1993	1995	486028
KLX	650	1996	1996	486028
KLX	650	1997	1998	486028
KLX	650	1993	1995	512125
KLX	650	1996	1996	512125
KLX	650	1997	1998	512125
KLX	650	1999	1999	512125
KLX	650	2000	2000	512125
NINJA R (USA)	650	2006	2008	512187
NINJA R (USA)	650	2009	2010	512187
NINJA R (USA)	650	2011	2012	512187
VULCAN S	650	2015	2015	512187
VULCAN S	650	2016	2016	512187
VULCAN S	650	2017	2017	512187
VULCAN S	650	2018	2019	512187
GPX R	750	1987	1987	512016
GPZ	750	1982	1982	480603
GPZ UT	750	1983	1985	512014
GPZ R/ RG / A	750	1985	1985	512016
GPZ R/ RG / A	750	1986	1986	512016
GT P	750	1982	1982	512011
GT P	750	1983	1985	512011
GT P	750	1986	1986	512011
GT P	750	1987	1992	512011
GT P	750	1993	1994	512011
NINJA ZX-R	750	1987	1989	512016
NINJA ZX-R	750	1990	1990	512016
NINJA ZX-7 / ZX H1/H2/ J1/J2	750	1991	1992	512024
NINJA ZX-7 / ZX H1/H2/ J1/J2	750	1993	1995	512024
NINJA ZX-7 R	750	1991	1995	512024
NINJA ZX-7 / ZX H1/H2/ J1/J2	750	1989	1989	512029
NINJA ZX-7 / ZX H1/H2/ J1/J2	750	1990	1990	512029
NINJA ZX-7 / ZX H1/H2/ J1/J2	750	1991	1992	512029
NINJA ZX-7 R	750	1996	2000	512029
NINJA ZX-7 R	750	2001	2002	512029
NINJA ZX-7 RR	750	1996	1998	512029
NINJA ZX-7 / ZX H1/H2/ J1/J2	750	1989	1989	486028
NINJA ZX-7 / ZX H1/H2/ J1/J2	750	1990	1990	486028
NINJA ZX-7 / ZX H1/H2/ J1/J2	750	1991	1992	486028
NINJA ZX-7 R	750	1996	2000	486028

ATHENA				
Modèle	Cylindre	Année début	Année fin	Réf.
NINJA ZX-7 R	750	2001	2002	486028
NINJA ZX-7 RR	750	1996	1998	486028
VN A VULCAN	750	1986	1986	512018
VN A VULCAN	750	1987	1996	512018
Z S/R	750	1980	1981	512010
Z S/R	750	1982	1982	512010
Z S/R	750	1983	1984	512010
Z S/R	750	1976	1978	480603
Z S/R	750	2011	2011	512026
Z S/R	750	2012	2012	512026
Z S/R	750	1980	1981	512051
Z S/R	750	1982	1982	512051
Z S/R	750	1983	1984	512051
Z S/R	750	2004	2006	512187
Z S/R	750	2007	2010	512187
Z S/R	750	2011	2011	512187
Z S/R	750	2012	2012	512187
Z S/R	750	2011	2011	512192
Z S/R	750	2012	2012	512192
ZR ZEPHIR C1 / C3	750	1991	1993	512024
ZR ZEPHIR C1 / C3	750	1994	1994	512024
ZR-7 F1-F3/S HI	750	1999	2002	512187
ZR-7 F1-F3/S HI	750	2003	2003	512187
ZX	750	1983	1983	512014
ZX	750	1984	1985	512014
ZX E / J / K / L / M / P / N	750	1991	1995	512024
ZXR J1 / J2 / L1 / L3	750	1993	1994	512024
ZXR R	750	1991	1991	512024
ZXR R	750	1992	1992	512024
ZXR R	750	1993	1994	512024
ZXR J1 / J2 / L1 / L3	750	1988	1990	512029
ZXR J1 / J2 / L1 / L3	750	1991	1992	512029
ZXR J1 / J2 / L1 / L3	750	1988	1990	486028
ZXR J1 / J2 / L1 / L3	750	1991	1992	486028
VN VULCAN	800	1995	1995	512026
VN VULCAN	800	1996	1997	512026
VN VULCAN	800	1998	1998	512026
VN VULCAN CLASSIC	800	1996	2000	512026
VN VULCAN CLASSIC	800	2001	2004	512026
VN VULCAN CLASSIC	800	2005	2005	512026
VN VULCAN CLASSIC	800	2006	2006	512026
VN VULCAN DRIFTER	800	1999	1999	512026
VN VULCAN DRIFTER	800	2000	2000	512026
VN VULCAN DRIFTER	800	2001	2001	512026
Z ABS	800	2013	2014	512187

ATHENA				
Modèle	Cylindre	Année début	Année fin	Réf.
Z ABS	800	2015	2015	512187
Z ABS	800	2016	2016	512187
GPZ R	900	1984	1985	512016
GPZ R	900	1986	1986	512016
GPZ R	900	1987	1989	512016
GPZ R	900	1990	1993	512024
GPZ R	900	1994	1994	512024
NINJA ZX-9 R	900	1994	1994	512024
NINJA ZX-9 R	900	1995	1995	512024
NINJA ZX-9 R	900	1996	1997	512024
NINJA ZX-9R / ZX B1 / B4 / C1	900	1994	1997	512024
NINJA ZX-9 R	900	1998	1999	512130
NINJA ZX-9 R	900	2000	2000	512130
NINJA ZX-9 R	900	2001	2001	512130
NINJA ZX-9 R	900	1998	1999	512135
NINJA ZX-9 R	900	2000	2000	512135
NINJA ZX-9 R	900	2001	2001	512135
NINJA ZX-9 R	900	2002	2002	512135
NINJA ZX-9R / ZX B1 / B4 / C1	900	1998	2001	512135
NINJA ZX-9R / ZX B1 / B4 / C1	900	2002	2002	512135
NINJA ZX B1 / B4 / C1 / C2	900	1998	1999	512135
NINJA ZX B1 / B4 / C1 / C2	900	2000	2001	512135
NINJA ZX-9R / ZX B1 / B4 / C1	900	2003	2003	512186
VULCAN CLASSIC / LT	900	2006	2006	512026
VULCAN CLASSIC / LT	900	2007	2014	512026
VULCAN CLASSIC / LT	900	2015	2015	512026
VULCAN CLASSIC / LT	900	2016	2019	512026
VULCAN COSTUM	900	2006	2006	512026
VULCAN COSTUM	900	2007	2007	512026
VULCAN COSTUM	900	2008	2014	512026
VULCAN COSTUM	900	2015	2015	512026
VULCAN CLASSIC / LT	900	2006	2006	512192
VULCAN CLASSIC / LT	900	2007	2014	512192
VULCAN COSTUM	900	2007	2007	512192
VULCAN COSTUM	900	2008	2014	512192
ZL ELIMINATOR	900	1985	1985	512018
ZL ELIMINATOR	900	1986	1986	512018
GPZ	1000	1986	1988	480623
GPZ	1000	1995	1995	512024
GPZ	1000	1996	1997	512024
GTR	1000	1986	1993	512024
GTR	1000	1994	1994	512024

ATHENA				
Modèle	Cylindre	Année début	Année fin	Réf.
GTR	1000	1995	1995	512024
GTR	1000	1996	1997	512024
GTR	1000	2003	2003	512187
KE 100 A5 / A10 / B1 / B15	1000	1976	1981	480600
KE 100 A5 / A10 / B1 / B15	1000	1982	1986	480600
KE 100 A5 / A10 / B1 / B15	1000	1987	1996	480600
KL V	1000	2004	2004	512178
KL V	1000	2005	2005	512178
KLZ VERSYS	1000	2012	2014	512181
KLZ VERSYS	1000	2016	2016	512181
KLZ VERSYS	1000	2017	2019	512181
KZ J / K / M / R / P	1000	1981	1982	512016
KZ J / K / M / R / P	1000	1983	1986	512016
KZ J / K / M / R / P	1000	1987	1996	512016
KZ J / K / M / R / P	1000	1997	1997	512016
KZ J / K / M / R / P	1000	1998	1998	512016
NINJA ZX-10R / ABS	1000	2011	2015	512180
NINJA ZX-10R / ABS	1000	2016	2016	512180
NINJA ZX-10R / ABS	1000	2017	2017	512180
NINJA ZX-10R / ABS	1000	2018	2019	512180
NINJA ZX-10R / ABS	1000	2004	2004	512181
NINJA ZX-10R / ABS	1000	2005	2005	512181
NINJA H2	1000	2015	2017	512183
NINJA H2R	1000	2015	2017	512183
NINJA ZX-10R / ABS	1000	2006	2007	512183
NINJA ZX-10R / ABS	1000	2008	2010	512183
Z	1000	1974	1975	480603
Z	1000	1976	1977	480603
Z	1000	1978	1978	480603
Z	1000	1979	1980	480603
Z	1000	1981	1981	512016
Z	1000	1982	1983	512016
Z SX	1000	2011	2013	512026
Z SX	1000	2017	2017	512026
Z SX	1000	2018	2019	512026
Z	1000	2003	2003	512026
Z	1000	2004	2006	512026
Z	1000	2007	2009	512026
Z	1000	2010	2011	512026
Z	1000	2012	2012	512026
Z	1000	2013	2013	512026
Z	1000	2014	2015	512026
Z	1000	2016	2016	512026
Z	1000	2017	2017	512026
Z	1000	2018	2019	512026

ATHENA				
Modèle	Cylindre	Année début	Année fin	Réf.
Z SX	1000	2011	2013	512192
Z SX	1000	2017	2017	512192
Z SX	1000	2018	2019	512192
Z	1000	2007	2009	512192
Z	1000	2010	2011	512192
Z	1000	2012	2012	512192
Z	1000	2013	2013	512192
Z	1000	2014	2015	512192
Z	1000	2016	2016	512192
Z	1000	2017	2017	512192
ZG A CONCOURS	1000	1986	1994	512024
ZG A CONCOURS	1000	1995	1995	512024
ZG A CONCOURS	1000	1996	1997	512024
ZG A CONCOURS	1000	1998	1998	512024
ZL A1 / A2 ELIMINATOR	1000	1987	1987	512018
ZX GPZ RX	1000	1986	1987	512022
ZX GBF NINJA	1000	2011	2014	512192
ZX-10	1000	1988	1988	512024
ZX-10	1000	1989	1990	512024
GPZ	1100	1984	1984	512014
GPZ	1100	1981	1982	512016
GPZ	1100	1983	1983	512016
Z	1100	1981	1981	512016
Z	1100	1982	1982	512016
Z	1100	1983	1983	512016
Z	1100	1984	1984	512016
ZR ZEPHYR / CHAIN DRIVE	1100	1992	1992	512029
ZR ZEPHYR / CHAIN DRIVE	1100	1993	1995	512029
ZR ZEPHYR / CHAIN DRIVE	1100	1992	1992	486028
ZR ZEPHYR / CHAIN DRIVE	1100	1993	1995	486028
ZX E1 / E3 / F1 GPZ	1100	1995	1997	512024
ZX C / D ZZ-R	1100	1990	1992	512029
ZX C / D ZZ-R	1100	1993	1997	512029
ZX C / D ZZ-R	1100	1998	1998	512029
ZX C / D ZZ-R	1100	1990	1992	486028
ZX C / D ZZ-R	1100	1993	1997	486028
ZX C / D ZZ-R	1100	1998	1998	486028
ZZ-R C1 / C3 / D1 / D7	1100	1990	1993	512029
ZZ-R C1 / C3 / D1 / D7	1100	1994	1994	512029
ZZ-R C1 / C3 / D1 / D7	1100	1995	1999	512029
ZZ-R C1 / C3 / D1 / D7	1100	1990	1993	486028
ZZ-R C1 / C3 / D1 / D7	1100	1994	1994	486028

MOTEUR

CYCLE

PNEUMATIQUE

ATELIER

ACCESSOIRES

ÉLECTRICITÉ

FILTRATION

FREINAGE

TRANSMISSION

ATHENA				
Modèle	Cylindre	Année début	Année fin	Réf.
ZZ-R C1/ C3/ D1/ D7	1100	1995	1999	486028
ZG A/ B VOYAGER X11	1200	1986	1998	512026
ZRX R/ S	1200	2001	2003	512176
ZRX R/ S	1200	2004	2004	512176
ZRX R/ S	1200	2005	2006	512176
ZX-12R	1200	2000	2006	512181
ZZ-R	1200	2002	2002	512176
ZZ-R	1200	2003	2003	512176
ZZ-R	1200	2004	2004	512176
Z	1300	1979	1981	512024
Z	1300	1982	1983	512024
GTR	1400	2008	2009	512181
GTR	1400	2010	2012	512181
GTR	1400	2013	2015	512181
NINJA ZX-14R	1400	2006	2006	512181
NINJA ZX-14R	1400	2007	2007	512181
NINJA ZX-14R	1400	2008	2010	512181
NINJA ZX-14R	1400	2011	2011	512181
NINJA ZX-14R	1400	2012	2013	512181
NINJA ZX-14R	1400	2014	2014	512181
NINJA ZX-14R	1400	2015	2017	512181
ZG	1400	2008	2012	512181
ZZR	1400	2006	2007	512181
ZZR	1400	2008	2009	512181
ZZR	1400	2010	2011	512181
ZZR	1400	2012	2014	512181
ZZR	1400	2015	2015	512181
ZZR	1400	2016	2017	512181
ZZR	1400	2018	2020	512181
VN A/ B/ C/ D/ E	1500	1987	1987	512026
VN A/ B/ C/ D/ E	1500	1988	1988	512026
VN A/ B/ C/ D/ E	1500	1989	1991	512026
VN A/ B/ C/ D/ E	1500	1992	1995	512026
VN A/ B/ C/ D/ E	1500	1996	1998	512026
VN B1/ B4/ C1/ C4 VULCAN	1500	1987	1990	512026
VN B1/ B4/ C1/ C4 VULCAN	1500	1996	1997	512026
VN CLASSIC	1500	1996	2006	512026
VN CLASSIC	1500	2007	2007	512026
VN CLASSIC TOURER	1500	1998	1999	512026
VN CLASSIC TOURER	1500	2000	2000	512026
VN CLASSIC TOURER FL	1500	2001	2002	512026
VN CLASSIC TOURER FL	1500	2003	2003	512026
VN DRIFTER	1500	1999	1999	512026
VN DRIFTER	1500	2000	2000	512026

ATHENA				
Modèle	Cylindre	Année début	Année fin	Réf.
VN E/ D VULCAN CLASSIC	1500	1996	1997	512026
VN E/ D VULCAN CLASSIC	1500	1998	1998	512026
VN E/ D VULCAN CLASSIC	1500	1999	1999	512026
VN MAIN STREAK	1500	2002	2002	512178
VN MAIN STREAK	1500	2003	2005	512178
VN MEAN STREAK	1600	2004	2004	512178
VN MEAN STREAK	1600	2005	2005	512178
VN MEAN STREAK	1600	2006	2006	512180
VN CLASSIC	1600	2003	2003	512182
VN CLASSIC	1600	2004	2006	512182
VN CLASSIC	1600	2007	2007	512182
VN CLASSIC TOURER	1600	2005	2006	512182
VN NOMAD	1600	2005	2005	512182
VN NOMAD	1600	2006	2006	512182
VN NOMAD	1600	2007	2007	512182
VULCAN VOYAGER / ABS	1700	2009	2009	512050
VULCAN VOYAGER / ABS	1700	2010	2011	512050
VULCAN VOYAGER / ABS	1700	2012	2015	512050
VULCAN VOYAGER / ABS	1700	2016	2017	512050
VULCAN CLASSIC / TOURER / NOMAD / VAQUERO	1700	2009	2009	512180
VULCAN CLASSIC / TOURER / NOMAD / VAQUERO	1700	2010	2013	512180
VULCAN CLASSIC / TOURER / NOMAD / VAQUERO	1700	2014	2015	512180
VN VULCAN CLASSIC / LT / USA	2000	2004	2004	512041
VN VULCAN CLASSIC / LT / USA	2000	2005	2009	512041
VN VULCAN CLASSIC / LT / USA	2000	2010	2010	512041

KTM				
Modèle	Cylindre	Année début	Année fin	Réf.
DUKE	125	2011	2011	512202
DUKE	125	2012	2014	512202
DUKE	125	2015	2015	512202
DUKE	125	2016	2016	512202
DUKE	125	2017	2019	512202
RC	125	2015	2015	512202
RC	125	2016	2018	512202
RC	125	2019	2019	512202
DUKE	200	2012	2013	512202
DUKE	200	2014	2014	512202
DUKE	200	2015	2015	512202

ATHENA				
Modèle	Cylindre	Année début	Année fin	Réf.
DUKE	200	2016	2016	512202
DUKE	200	2017	2018	512202
DUKE	200	2019	2019	512202
RC	200	2015	2015	512202
RC	200	2016	2016	512202
RC	200	2017	2018	512202
RC	200	2019	2019	512202
DUKE	250	2015	2016	512202
DUKE	250	2017	2018	512202
DUKE	250	2019	2019	512202
RC	250	2015	2015	512202
RC	250	2016	2016	512202
DUKE	390	2013	2016	512202
DUKE	390	2017	2018	512202
DUKE	390	2019	2019	512202
RC	390	2015	2015	512202
RC	390	2016	2018	512202
RC	390	2019	2019	512202
LC4-E	400	1999	1999	512043
LC4-E	400	2000	2001	512043
LC4-E	400	2002	2002	512043
LC4-E	400	2000	2001	512128
DUKE 620	600	1994	1994	512037
DUKE 620	600	1996	1996	512037
DUKE	620	1994	1995	512037
DUKE	620	1996	1996	512043
DUKE	620	1997	1998	512043
EGS LC4	620	1994	1994	512037
EGS LC4	620	1995	1995	512037
EGS LC4	620	1996	1998	512043
LC4	620	1997	1998	512043
LC4	620	1999	1999	512043
LC4	620	2000	2001	512128
LC4-E	620	1999	1999	512043
LC4-E	620	2000	2001	512043
LC4-E	620	2002	2002	512043
LC4-E	620	2000	2001	512128
SMC	625	2005	2005	512172
SMC	625	2006	2006	512172
SMC	625	2003	2003	512173
SMC	625	2004	2004	512173
SMC	625	2005	2005	512173
SMC	625	2006	2006	512173
SXC	625	2003	2003	512143
SXC	625	2004	2004	512143

ATHENA				
Modèle	Cylindre	Année début	Année fin	Réf.
SXC	625	2005	2005	512143
SXC	625	2006	2006	512143
SXC	625	2007	2007	512143
SXC	625	2003	2003	512145
SXC	625	2004	2004	512145
SXC	625	2005	2005	512145
SXC	625	2006	2006	512145
SXC	625	2007	2007	512145
DUKE	640	2000	2002	512143
DUKE	640	2003	2003	512143
DUKE	640	2004	2004	512143
DUKE	640	2000	2002	512145
DUKE	640	2003	2003	512145
DUKE	640	2004	2004	512145
LC4 SUPERMOTO	640	2003	2003	512143
LC4 SUPERMOTO	640	2004	2004	512143
LC4 SUPERMOTO	640	2003	2003	512145
LC4 SUPERMOTO	640	2004	2004	512145
LC4 SUPERMOTO	640	2003	2003	512172
LC4 SUPERMOTO	640	2004	2004	512172
LC4 SUPERMOTO	640	2005	2005	512172
LC4 SUPERMOTO	640	2006	2006	512172
LC4 SUPERMOTO	640	2007	2007	512172
LC4 SUPERMOTO	640	2008	2009	512172
LC4 SUPERMOTO	640	2010	2013	512172
LC4 SUPERMOTO	640	2003	2003	512173
LC4 SUPERMOTO	640	2004	2004	512173
LC4 SUPERMOTO	640	2005	2005	512173
LC4 SUPERMOTO	640	2006	2006	512173
LC4 SUPERMOTO	640	2007	2007	512173
LC-4 ADVENTURE	640	2005	2007	512172
LC4-E	640	2000	2001	512143
LC4-E	640	2002	2002	512143
LC4-E	640	2003	2004	512143
LC4-E	640	2000	2001	512145
LC4-E	640	2002	2002	512145
LC4-E	640	2003	2004	512145
LC4-E	640	2003	2004	512172
LC4-E	640	2005	2005	512172
LC4-E	640	2006	2006	512172
LC4-E	640	2007	2007	512172
LC4-E	640	2003	2004	512173
LC4-E	640	2005	2005	512173
LC4-E	640	2006	2006	512173
LC4-E	640	2007	2007	512173

MOTEUR

CYCLE

PNEUMATIQUE

ATELIER

ACCESSOIRES

ÉLECTRICITÉ

FILTRATION

FREINAGE

TRANSMISSION

ATHENA				
Modèle	Cylindre	Année début	Année fin	Réf.
R ADVENTURE	640	2003	2004	512143
R ADVENTURE	640	2003	2004	512145
R ADVENTURE	640	2003	2004	512172
R ADVENTURE	640	2005	2006	512172
R ADVENTURE	640	2003	2004	512173
R ADVENTURE	640	2005	2006	512173
SMC	660	2003	2003	512143
SMC	660	2004	2004	512143
SMC	660	2003	2003	512145
SMC	660	2004	2004	512145
SMC	660	2003	2003	512172
SMC	660	2004	2004	512172
SMC	660	2005	2005	512172
SMC	660	2006	2006	512172
SMC	660	2003	2003	512173
SMC	660	2004	2004	512173
SMC	660	2005	2005	512173
SMC	660	2006	2006	512173
DUKE R	690	2010	2011	512146
DUKE	690	2008	2011	512146
DUKE	690	2012	2012	512146
DUKE	690	2008	2011	512172
DUKE	690	2013	2015	512202
DUKE	690	2016	2017	512202
DUKE	690	2018	2019	512202
ENDURO R	690	2008	2008	512146
ENDURO R	690	2009	2009	512146
ENDURO R	690	2010	2010	512146
ENDURO R	690	2011	2011	512146
ENDURO R	690	2012	2013	512146
ENDURO	690	2008	2008	512146
ENDURO	690	2009	2010	512146
ENDURO	690	2011	2011	512146
ENDURO	690	2012	2013	512146
ENDURO R	690	2008	2008	512172
ENDURO R	690	2009	2009	512172
ENDURO R	690	2010	2010	512172
ENDURO R	690	2011	2011	512172
ENDURO R	690	2012	2013	512172
SMC	690	2008	2008	512146
SMC	690	2009	2009	512146
SMC	690	2010	2010	512146
SMC	690	2011	2011	512146
SMC	690	2012	2013	512146
SUPERMOTO	690	2008	2008	512172

ATHENA				
Modèle	Cylindre	Année début	Année fin	Réf.
SUPERMOTO	690	2009	2009	512172
SUPERMOTO	690	2010	2011	512172
SUPERMOTO	690	2012	2012	512172
LC8 ADVENTURE	950	2005	2006	512172
LC8 ADVENTURE	950	2007	2008	512172
LC8 ADVENTURE R	950	2005	2008	512172
LC8 ADVENTURE	950	2002	2002	512173
LC8 ADVENTURE	950	2003	2004	512173
LC8 ADVENTURE	950	2005	2006	512173
LC8 ADVENTURE S	950	2003	2006	512173
SUPER ENDURO	950	2008	2008	512173
SUPER ENDURO	950	2009	2009	512173
SUPER ENDURO	950	2010	2011	512173
SUPER ENDURO	950	2012	2018	512173
SUPER ENDURO R	950	2006	2006	512173
SUPER ENDURO R	950	2007	2008	512173
SUPERMOTO R	950	2007	2008	512173
SUPERMOTO	950	2005	2005	512173
SUPERMOTO	950	2006	2007	512173
LC8 ADVENTURE / S / ABS	990	2006	2009	512172
LC8 ADVENTURE / S / ABS	990	2010	2013	512172
LC8 ADVENTURE R	990	2008	2008	512172
LC8 ADVENTURE R	990	2009	2009	512172
LC8 ADVENTURE R	990	2010	2011	512172
LC8 ADVENTURE R	990	2012	2012	512172
LC8 ADVENTURE R	990	2013	2013	512172
LC8 ADVENTURE / S / ABS	990	2006	2009	512173
LC8 ADVENTURE / S / ABS	990	2010	2013	512173
LC8 ADVENTURE R	990	2009	2009	512173
LC8 ADVENTURE R	990	2010	2011	512173
LC8 ADVENTURE R	990	2012	2012	512173
LC8 ADVENTURE R	990	2005	2005	512173
LC8 SUPER DUKE	990	2006	2009	512173
LC8 SUPER DUKE R	990	2007	2008	512173
LC8 SUPER DUKE R	990	2009	2009	512173
LC8 SUPER DUKE R	990	2010	2013	512173
SUPERMOTO R	990	2009	2009	512173
SUPERMOTO R	990	2010	2013	512173
SUPERMOTO T	990	2008	2009	512173
SUPERMOTO T	990	2010	2011	512173
SUPERMOTO T	990	2012	2012	512173
SUPERMOTO T	990	2013	2013	512173

ATHENA				
Modèle	Cylindre	Année début	Année fin	Réf.
RC8 R	1190	2009	2010	512143
RC8	1190	2008	2010	512143
RC8 R	1190	2009	2010	512145
RC8	1190	2008	2010	512145
RC8 R	1190	2011	2015	512202
RC8 R	1190	2016	2016	512202

MOTO GUZZI				
NEVADA CLUB	350	1998	1999	493905
NEVADA NUOVO TIPO	350	1993	1997	493905
NEVADA NUOVO TIPO	350	1998	1999	493905
NEVADA VECCHIO TIPO	350	1992	1993	493905
VI 35 CUSTOM	350	1985	1987	493905
VI 35 FLORIDA	350	-	-	493905
VI 35 II / III	350	1983	1988	493905
VI 35	350	1983	1988	493905
VI 35 TT ENDURO	350	1984	1984	512017
VI 35 II	350	-	-	512038
VI 35 IMOLA	350	-	-	512038
VI 35	350	-	-	512038
VI 50 / CUSTOM	500	1982	1985	493905
VI 50 / CUSTOM	500	1992	1992	493905
VI 50 I / II / III / MONZA	500	1981	1986	512038
V 65 LARIO	650	1984	1988	493905
V 65 SP CHOPPER	650	1981	1981	493905
V LARIO	650	1984	1984	493905
V 65 POLIZIA PA NUOVO TIPO	650	1988	1995	512017
V 65 TT	650	1985	1988	512017
VI 65 CUSTOM	650	1984	1985	493905
VI 65 CUSTOM	650	1986	1987	493905
VI 65 FLORIDA	650	1985	1992	493905
VI 65 II ENDURO	650	1984	1984	493905
VI 65	650	1981	1988	493905
VT TT BAJA	650	1986	1986	512017
BREVA	750	2003	2003	486025
BREVA	750	2004	2007	486025
NEVADA NT / CLUB	750	1993	1996	493905
NEVADA NT / CLUB	750	1997	1997	493905
NEVADA NT / CLUB	750	1998	1999	493905
NEVADA NUOVO TIPO	750	1993	1997	493905
NEVADA CLASSIC / AQUILA NERA	750	2004	2005	486025
NEVADA CLASSIC / AQUILA NERA	750	2006	2006	486025
NEVADA CLASSIC / AQUILA NERA	750	2007	2010	486025

ATHENA				
Modèle	Cylindre	Année début	Année fin	Réf.
NEVADA	750	2002	2003	486025
S S3	750	-	-	493905
SP	750	1990	1990	493905
SP	750	1991	1992	493905
SPORT	750	1980	1984	493905
STRADA	750	1993	1993	493905
STRADA	750	1994	1995	493905
TARGA	750	1990	1992	493905
V7 CAFE' CLASSIC	750	2009	2009	486025
V7 CAFE' CLASSIC	750	2010	2012	486025
V7 CLASSIC	750	2008	2009	486025
V7 RACER	750	2012	2012	486025
V7 SPECIAL - STONE	750	2012	2012	486025
VI 75 PA VECCHIO / NUOVO TIPO	750	1992	1996	493905
VI 75	750	1985	1988	512017
X POLIZIA PA I / II S	750	1992	1995	480623
BREVA	850	2006	2007	512047
NORGE	850	2007	2007	512047
BELLAGIO AQUILA NERA	940	2007	2010	512047
CALIFORNIA II	1000	1981	1982	493905
CALIFORNIA II	1000	1983	1984	493905
CALIFORNIA II	1000	1985	1987	493905
CALIFORNIA III CARB	1000	1987	1993	480623
CALIFORNIA INIEZ	1000	1990	1993	480623
GT	1000	1987	1991	512017
LE MANS	1000	1984	1993	480623
S	1000	1989	1989	480623
S	1000	1990	1990	480623
S	1000	1991	1993	480623
S	1000	1994	1994	480623
SP II	1000	1984	1987	512017
SP II	1000	1988	1988	512017
STRADA	1000	1993	1993	480623
STRADA	1000	1994	1994	480623
BREVA	1100	2005	2007	512047
CALIFORNIA III CARB. CARENATO	1100	1988	1990	480623
CALIFORNIA AQUILA NERA / VINTAGE	1100	2010	2010	512047
CALIFORNIA CLASSIC - TOURING	1100	2006	2007	512047
CALIFORNIA STONE / STONE TOURING	1100	2004	2005	512047
CALIFORNIA VINTAGE	1100	2006	2007	512047
CALIFORNIA VINTAGE	1100	2008	2008	512047
CALIFORNIA VINTAGE	1100	2009	2012	512047

ATHENA				
Modèle	Cylindre	Année début	Année fin	Réf.
BREVA SPORT	1200	2008	2008	512047
GRISO 8V	1200	2007	2007	512120
GRISO 8V	1200	2008	2013	512120
GRISO 8V	1200	2014	2015	512120
NORGE GT 8V	1200	2010	2013	512047
NORGE	1200	2006	2006	512047
NORGE	1200	2007	2007	512047
SPORT 8V	1200	2009	2009	512047
SPORT	1200	2006	2006	512047
SPORT	1200	2007	2007	512047
STELVIO NTX ABS	1200	2008	2008	512044
STELVIO NTX ABS	1200	2009	2009	512044
STELVIO NTX ABS	1200	2010	2011	512047
STELVIO NTX ABS	1200	2012	2013	512047
STELVIO NTX ABS	1200	2014	2015	512047
MV AGUSTA				
BRUTALE S	750	2003	2005	512044
F4 S	750	2001	2003	512044
BRUTALE S / R	910	2005	2005	512044
BRUTALE S / R	910	2006	2006	512044
BRUTALE S / R	910	2007	2008	512044
BRUTALE	920	2010	2010	512044
BRUTALE	920	2011	2011	512044
BRUTALE R	990	2010	2010	512044
BRUTALE R	990	2011	2011	512044
F4 312/ 312 RR	1000	2007	2008	512044
F4 R	1000	2004	2005	512044
F4 R	1000	2006	2007	512044
F4 RR	1000	2008	2009	512044
F4 RR	1000	2010	2011	512044
F4 RR	1000	2012	2013	512044
F4 S	1000	2004	2006	512044
F4 S	1000	2007	2007	512044
F4	1000	2004	2006	512044
F4	1000	2007	2007	512044
BRUTALE RR	1078	2008	2008	512044
BRUTALE RR	1078	2009	2009	512044
1090 BRUTALE RR	1090	2010	2011	512044
1090 BRUTALE RR	1090	2012	2013	512044
SUZUKI				
DR SE Z / T	125	1982	1984	512004
DR SE Z / T	125	1986	1988	493902
DR SE Z / T	125	1994	1995	512020
DR SE Z / T	125	1996	1996	512020
DR SE Z / T	125	1982	1984	480619

ATHENA				
Modèle	Cylindre	Année début	Année fin	Réf.
GN	125	1982	1990	512004
GN	125	1991	1996	512004
GN	125	1997	1997	512004
GS E / KATANA	125	1982	1982	480600
GS E / KATANA	125	1983	1989	480600
GS E / KATANA	125	1990	1994	480600
GZ MARAUDER	125	1998	1999	512015
RG	125	1985	1991	480600
RG F / GAMMA	125	1992	1992	512020
RG F / GAMMA	125	1993	1994	512020
RV VAN	125	1973	1977	480600
TS X	125	1984	1984	493902
TS X	125	1985	1987	493902
TS X	125	1988	1989	493902
TS X	125	1990	1990	493902
TS R/ER	125	1990	1993	512026
TS R/ER	125	1994	1994	512026
VL INTRUDER	125	2000	2000	512199
VL INTRUDER	125	2001	2002	512199
VL INTRUDER	125	2003	2007	512199
DR SE / S	200	1986	1988	493902
DR SE / S	200	1989	1990	493902
DR SE / S	200	1996	1998	493902
DR	250	1982	1984	512010
DR	250	1985	1985	512010
DR	250	1990	1995	512028
DR	250	1996	1996	512028
DR	250	1982	1984	512051
DR	250	1985	1985	512051
DR	250	1990	1995	512120
DR	250	1996	1996	512120
GN	250	1982	1984	512006
GN	250	1985	1985	512006
GN	250	1986	1986	512006
GN	250	1987	1996	512006
GW F INAZUMA	250	2013	2013	512199
GW F INAZUMA	250	2014	2014	512199
GW F INAZUMA	250	2015	2017	512199
GZ MARAUDER	250	1998	1998	512015
GZ MARAUDER	250	1999	1999	512015
TU X VOLTY V / W	250	1997	1998	512015
VL INTRUDER	250	2000	2000	512199
VL INTRUDER	250	2001	2001	512199
VL INTRUDER	250	2002	2004	512199
VL INTRUDER	250	2005	2005	512199

ATHENA				
Modèle	Cylindre	Année début	Année fin	Réf.
VL INTRUDER	250	2006	2007	512199
DR S/ SE	350	1992	1994	512026
DR S/ SE	350	1990	1991	512028
DR S/ SE	350	1992	1994	512028
DR S/ SE	350	1995	1995	512028
DR S/ SE	350	1996	1996	512028
DR S/ SE	350	1997	1997	512028
DR S/ SE	350	1998	1998	512028
DR S/ SE	350	1990	1991	512120
DR S/ SE	350	1992	1994	512120
DR S/ SE	350	1995	1995	512120
DR S/ SE	350	1996	1996	512120
DR S/ SE	350	1997	1997	512120
DR S/ SE	350	1998	1998	512120
DR	400	1980	1981	480603
DR-Z S	400	2000	2000	512041
DR-Z S	400	2001	2004	512041
DR-Z S	400	2005	2006	512041
DR-Z S	400	2007	2009	512041
DR-Z S	400	2010	2012	512041
DR-Z SM	400	2005	2005	512042
DR-Z SM	400	2006	2009	512042
DR-Z S	400	2000	2000	512124
DR-Z S	400	2001	2004	512124
DR-Z S	400	2005	2006	512124
DR-Z S	400	2007	2009	512124
DR-Z SM	400	2005	2005	512139
DR-Z SM	400	2006	2009	512139
G S F BANDIT	400	1991	1992	480624
G S F BANDIT	400	1993	1993	480624
G S X ET / ES	400	1980	1980	493902
G S X ET / ES	400	1981	1981	493902
G S X ET / ES	400	1982	1983	493902
G S X ET / ES	400	1984	1984	493902
G S X ET / ES	400	1985	1987	493902
G S X S / E / L	400	1980	1981	493902
G S X - R	400	1987	1987	512018
DR	500	1981	1983	512010
DR	500	1981	1983	512051
G S E	500	1978	1979	493902
G S E	500	1989	1995	512014
G S E	500	1996	1996	512014
R G	500	1985	1985	512016
R G	500	1986	1987	512016

ATHENA				
Modèle	Cylindre	Année début	Année fin	Réf.
G S E / EF / ES / L CHAIN DRIVE	550	1983	1984	512014
G S E / EF / ES / L CHAIN DRIVE	550	1985	1986	512014
D R R / S / J / H	600	1985	1985	512020
D R R / S / J / H	600	1986	1988	512020
D R R / S / J / H	600	1989	1989	512020
G S F BANDIT	600	2000	2003	480624
G S F BANDIT	600	2004	2004	480624
G S F S BANDIT	600	1995	1995	480624
G S F S BANDIT	600	1996	1998	480624
G S R	600	2006	2010	512182
G S X F	600	1988	1989	512026
G S X F	600	1990	1995	512026
G S X F	600	1996	1996	512026
G S X F	600	1997	1997	512026
G S X F	600	1998	1998	512026
G S X F	600	1999	2000	512026
G S X F	600	2001	2002	512026
G S X F	600	2003	2006	512026
G S X - R	600	1992	1995	512026
G S X - R	600	1996	1996	512026
G S X - R	600	1997	1998	512026
G S X - R	600	1999	1999	512026
G S X - R	600	2000	2000	512026
G S X - R	600	2001	2001	512026
G S X - R	600	2002	2003	512026
G S X - R	600	2004	2004	512026
G S X - R	600	2005	2005	512026
G S X - R	600	2006	2007	512026
G S X - R	600	2008	2010	512026
G S X - R	600	2011	2011	512026
G S X - R	600	2012	2014	512026
G S X - R	600	2015	2015	512026
G S X - R	600	2016	2017	512026
G S X - R	600	1997	1998	512031
G S X - R	600	1999	1999	512031
G S X - R	600	2000	2000	512031
G S X - R	600	2001	2001	512031
G S X - R	600	2002	2003	512031
G S X - R	600	1997	1998	512050
G S X - R	600	1999	1999	512050
G S X - R	600	2004	2004	512180
G S X - R	600	2005	2005	512180
G S X - R	600	2006	2007	512192
G S X - R	600	2008	2010	512192

ATHENA				
Modèle	Cylindre	Année début	Année fin	Réf.
GSX-R	600	2011	2011	512192
GSX-R	600	2012	2014	512192
GSX-R	600	2015	2015	512192
GSX-R	600	2016	2017	512192
RF R	600	1993	1994	512026
RF R	600	1995	1996	512026
VS GL INTRUDER S-V	600	1995	1996	512021
VS GL INTRUDER S-V	600	1997	1997	512021
DL V-STROM	650	2004	2004	512180
DL V-STROM	650	2005	2006	512180
DL V-STROM	650	2007	2010	512180
DL V-STROM	650	2011	2011	512180
DR R / RU / RSU	650	1990	1990	512024
DR R / RU / RSU	650	1991	1993	512024
DR R / RU / RSU	650	1994	1995	512024
DR R / RU / RSU	650	1996	1996	512024
DR SE	650	1996	1996	512030
DR SE	650	1997	1997	512030
DR SE	650	1998	2006	512030
DR SE	650	2007	2009	512030
GSF BANDIT / S	650	2005	2005	512174
GSF BANDIT / S	650	2006	2006	512174
GSF BANDIT / S	650	2007	2010	512187
GSF BANDIT / S	650	2011	2012	512187
GSX F	650	2008	2008	512187
GSX F	650	2009	2009	512187
GSX F	650	2010	2012	512187
LS F / P / SAVAGE	650	1986	1988	512016
LS F / P / SAVAGE	650	1989	1994	512016
LS F / P / SAVAGE	650	1995	1995	512016
LS F / P / SAVAGE	650	1996	1996	512016
LS F / P / SAVAGE	650	1997	1997	512016
LS F / P / SAVAGE	650	1998	1998	512016
SFV GLADIUS	650	2009	2013	512026
SFV GLADIUS	650	2014	2015	512026
SFV GLADIUS	650	2009	2013	512192
SFV GLADIUS	650	2014	2015	512192
SV	650	2003	2004	512026
SV	650	2005	2007	512026
SV	650	2008	2009	512026
SV	650	2010	2010	512026
SV	650	2011	2015	512026
SV	650	2016	2019	512026
SV	650	1999	2001	512174
SV	650	2002	2002	512174

ATHENA				
Modèle	Cylindre	Année début	Année fin	Réf.
SV	650	2003	2004	512192
SV	650	2005	2007	512192
SV	650	2008	2009	512192
XF FREEWIND	650	1997	2000	512029
XF FREEWIND	650	2001	2001	512029
XF FREEWIND	650	1997	2000	486028
XF FREEWIND	650	2001	2001	486028
XS	650	1997	1997	512029
XS	650	1997	1997	486028
VS GL INTRUDER	700	1986	1986	512015
VS GL INTRUDER	700	1987	1987	512015
DR	750	1988	1988	512024
DR	750	1989	1989	512024
GSR	750	2011	2012	512187
GSR	750	2013	2013	512187
GSX	750	1980	1980	493902
GSX	750	1981	1982	493902
GSX F KATANA	750	1982	1982	512014
GSX	750	1985	1985	512015
GSX	750	1986	1986	512015
GSX F KATANA	750	1989	1995	512026
GSX F KATANA	750	1996	1996	512026
GSX F KATANA	750	1997	1997	512026
GSX F KATANA	750	1998	1998	512026
GSX F KATANA	750	1999	1999	512026
GSX F KATANA	750	2000	2000	512026
GSX F KATANA	750	2001	2006	512026
GSX	750	1998	1998	512028
GSX	750	1999	1999	512028
GSX	750	2000	2001	512028
GSX	750	1998	1998	512120
GSX	750	1999	1999	512120
GSX-R W / T / V	750	1992	1992	512026
GSX-R W / T / V	750	1993	1993	512026
GSX-R	750	1990	1990	512026
GSX-R	750	1991	1991	512026
GSX-R	750	1992	1992	512026
GSX-R	750	1993	1993	512026
GSX-R	750	2006	2007	512026
GSX-R	750	2008	2010	512026
GSX-R	750	2011	2011	512026
GSX-R	750	2012	2013	512026
GSX-R	750	2014	2015	512026
GSX-R	750	2016	2017	512026
GSX-R	750	2018	2018	512026

ATHENA				
Modèle	Cylindre	Année début	Année fin	Réf.
GSX-R SP R	750	1994	1994	512028
GSX-R W / T / V	750	1994	1995	512028
GSX-R	750	1988	1989	512028
GSX-R	750	1996	1999	512028
GSX-R	750	2000	2000	512028
GSX-R	750	2001	2003	512028
GSX-R	750	1985	1987	480624
GSX-R SP R	750	1994	1994	512120
GSX-R W / T / V	750	1994	1995	512120
GSX-R	750	1988	1989	512120
GSX-R	750	1996	1999	512120
GSX-R	750	2000	2000	512120
GSX-R	750	2001	2003	512120
GSX-R	750	2004	2004	512180
GSX-R	750	2005	2005	512180
GSX-R	750	2006	2007	512192
GSX-R	750	2008	2010	512192
GSX-R	750	2011	2011	512192
GSX-R	750	2012	2013	512192
GSX-R	750	2014	2015	512192
GSX-R	750	2016	2017	512192
VS GL INTRUDER	750	1985	1985	512015
VS GL INTRUDER	750	1986	1986	512015
VS GL INTRUDER	750	1987	1987	512015
VS GL INTRUDER	750	1988	1991	512021
DR S M / P	800	1990	1990	512024
DR S M / P	800	1991	1993	512030
DR S M / P	800	1994	1994	512030
DR S M / P	800	1995	1995	512030
VL INTRUDER / TOURING / CUSTOM VOLUSIA	800	2001	2003	512026
VL INTRUDER / TOURING / CUSTOM VOLUSIA	800	2004	2004	512026
VL INTRUDER / TOURING / CUSTOM VOLUSIA	800	2005	2005	512026
VL INTRUDER / TOURING / CUSTOM VOLUSIA	800	2006	2008	512026
VL INTRUDER C / VZ INTRUDER M	800	2006	2008	512026
VL INTRUDER C / VZ INTRUDER M	800	2009	2009	512026
VL INTRUDER C / VZ INTRUDER M	800	2010	2010	512026
VL INTRUDER C / VZ INTRUDER M	800	2011	2011	512026
VL INTRUDER C / VZ INTRUDER M	800	2012	2014	512026
VL INTRUDER C / VZ INTRUDER M	800	2015	2015	512026

ATHENA				
Modèle	Cylindre	Année début	Année fin	Réf.
VS GL INTRUDER	800	1992	1995	512021
VS GL INTRUDER	800	1996	1997	512021
VS GL INTRUDER	800	1998	1998	512021
VX	800	1990	1993	480624
VX	800	1994	1994	480624
VX	800	1995	1996	480624
VZ MARAUDER	800	1997	2000	480624
VZ MARAUDER	800	2001	2002	480624
VZ INTRUDER	800	2005	2005	512187
VZ INTRUDER	800	2006	2008	512187
VZ INTRUDER	800	2009	2009	512187
VZ INTRUDER	800	2010	2011	512187
RF R R / T	900	1994	1996	512028
RF R R / T	900	1997	1997	512028
RF R R / T	900	1994	1996	512120
RF R R / T	900	1997	1997	512120
DL V-STROM	1000	2002	2004	512028
DL V-STROM	1000	2005	2010	512028
DL V-STROM - M.Y.2014	1000	2014	2017	512182
DL V-STROM - M.Y.2014	1000	2018	2019	512182
GSX-R	1000	2009	2010	512180
GSX-R	1000	2011	2011	512180
GSX-R	1000	2012	2015	512180
GSX-R	1000	2016	2016	512180
GSX-R	1000	2017	2017	512180
GSX-R	1000	2018	2019	512180
GSX-R	1000	2001	2002	512183
GSX-R	1000	2003	2003	512183
GSX-R	1000	2004	2004	512183
GSX-R	1000	2005	2006	512183
GSX-R	1000	2007	2008	512183
SV	1000	2003	2003	512130
SV	1000	2004	2004	512130
SV	1000	2005	2005	512130
SV	1000	2006	2006	512130
SV	1000	2003	2003	512135
SV	1000	2004	2004	512135
SV	1000	2005	2005	512135
TL R / S	1000	1997	1997	512029
TL R / S	1000	1998	1998	512029
TL R / S	1000	1999	2000	512029
TL R / S	1000	2001	2001	512029
TL R / S	1000	1997	1997	486028
TL R / S	1000	1998	1998	486028
TL R / S	1000	1999	2000	486028

MOTEUR

CYCLE

PNEUMATIQUE

ATELIER

ACCESSOIRES

ÉLECTRICITÉ

FILTRATION

FREINAGE

TRANSMISSION

ATHENA				
Modèle	Cylindre	Année début	Année fin	Réf.
TL R / S	1000	2001	2001	486028
GS GZ / GKD	1100	1982	1982	512024
GS GZ / GKD	1100	1983	1983	512024
GS GZ / GKD	1100	1984	1984	512024
GSX Z / XD / SD / EFE / EFG / KATANA	1100	1980	1981	512014
GSX Z / XD / SD / EFE / EFG / KATANA	1100	1982	1983	512014
GSX Z / XD / SD / EFE / EFG / KATANA	1100	1984	1984	512014
GSX Z / XD / SD / EFE / EFG / KATANA	1100	1986	1987	512024
GSX Z / XD / SD / EFE / EFG / KATANA	1100	1988	1988	512024
GSX Z / XD / SD / EFE / EFG / KATANA	1100	1990	1990	512024
GSX F / G L-P SHAFT / KATANA	1100	1988	1989	512026
GSX F / G L-P SHAFT / KATANA	1100	1990	1990	512026
GSX F / G L-P SHAFT / KATANA	1100	1991	1992	512026
GSX F / G L-P SHAFT / KATANA	1100	1993	1993	512026
GSX F / G L-P SHAFT / KATANA	1100	1994	1994	512026
GSX F / G L-P SHAFT / KATANA	1100	1991	1992	512030
GSX F / G L-P SHAFT / KATANA	1100	1993	1993	512030
GSX F / G L-P SHAFT / KATANA	1100	1994	1994	512030
GSX-R	1100	1989	1989	512029
GSX-R	1100	1986	1987	480624
GSX-R	1100	1988	1988	480624
GSX-R	1100	1989	1989	480624
GSX-R	1100	1990	1990	480624
GS	1150	1983	1983	512014
GS	1150	1984	1985	512014
GS	1150	1986	1986	512014
GSF BANDIT	1200	1996	1996	512028
GSF BANDIT	1200	1997	1999	512028
GSF BANDIT	1200	2000	2000	512028
GSF BANDIT	1200	2001	2001	512028
GSF BANDIT	1200	2002	2005	512028
GSF BANDIT	1200	1996	1996	512120
GSF BANDIT	1200	1997	1999	512120
GSF BANDIT	1200	2006	2006	512180
GSF BANDIT	1200	2007	2008	512180
GSF BANDIT	1200	2009	2012	512180

ATHENA				
Modèle	Cylindre	Année début	Année fin	Réf.
GSX	1200	1999	1999	512028
GSX	1200	2000	2001	512028
GSF BANDIT / S / SA	1250	2007	2008	512120
GSF BANDIT / S / SA	1250	2009	2010	512120
GSF BANDIT / S / SA	1250	2011	2014	512120
GSF BANDIT / S / SA	1250	2015	2016	512120
GSX FA	1250	2010	2011	512180
GSX FA	1250	2012	2012	512180
GSX	1250	2010	2010	512180
GSX	1250	2011	2011	512180
GSX	1250	2012	2012	512180
GSX B-KING	1300	2008	2008	512183
GSX B-KING	1300	2009	2009	512183
GSX B-KING	1300	2010	2010	512183
GSX-R HAYABUSA	1300	1999	1999	486028
GSX-R HAYABUSA	1300	2000	2006	486028
GSX-R HAYABUSA	1300	2007	2007	486028
GSX-R HAYABUSA	1300	2008	2010	512183
GSX-R HAYABUSA	1300	2011	2012	512183
GSX-R HAYABUSA	1300	2013	2014	512183
GSX	1400	2002	2002	512135
GSX	1400	2003	2003	512135
GSX	1400	2004	2006	512135
VS GL / GLP INTRUDER	1400	1987	1987	512026
VS GL / GLP INTRUDER	1400	1988	1995	512026
VS GL / GLP INTRUDER	1400	1996	1996	512026
VS GL / GLP INTRUDER	1400	1997	1998	512026
VL INTRUDER LC W / R	1500	1998	1998	512026
VL INTRUDER LC W / R	1500	1999	2000	512026
VL INTRUDER LC W / R	1500	2001	2001	512026
VL INTRUDER LC W / R	1500	2002	2002	512026
VL INTRUDER LC W / R	1500	2003	2003	512026
VL INTRUDER LC W / R	1500	2004	2006	512026
VZ INTRUDER M	1600	2004	2004	512178
VZ INTRUDER M	1600	2005	2005	512178

TRIUMPH				
Modèle	Cylindre	Année début	Année fin	Réf.
SPEED TRIPLE	900	1994	1994	512030
TIGER	900	1993	1994	512030
TRIDENT SPRINT	900	1993	1994	512030
TRIDENT 750	900	1991	1994	512030
DAYTONA 750	1000	1991	1992	512030
DAYTONA 900	1200	1993	1994	512030
TROPHY 900	1200	1991	1994	512030
DAYTONA SUPER3		1994	1994	512030

				
Modèle	Cylindre	Année début	Année fin	Réf.
YAMAHA				
DT RD	125	1974	1976	480600
DT RD	125	1978	1978	512001
DT RD	125	1979	1979	512004
DT RD	125	1980	1981	512004
DT RD	125	1982	1982	493902
DT RD	125	1985	1985	512011
DT RD	125	1986	1986	512011
DT RD	125	1987	1987	512011
DT R/RE/X	125	1988	1988	512024
DT R/RE/X	125	1989	1989	512025
DT R/RE/X	125	1990	1991	512025
DT R/RE/X	125	1992	1992	512025
RD LC YPVS	125	1978	1981	480600
RD LC YPVS	125	1982	1982	493904
RD LC YPVS	125	1983	1984	493904
SR	125	1982	1982	493904
SR	125	1993	1994	493904
TDR	125	1993	1993	512016
TDR	125	1994	1994	512016
TDR	125	1988	1988	512017
TDR	125	1989	1989	512017
TDR	125	1990	1990	512017
TDR	125	1991	1991	512017
TDR	125	1992	1992	512017
TDR	125	1989	1989	512025
TDR	125	1990	1990	512025
TDR	125	1991	1991	512025
TDR	125	1992	1992	512025
TDR	125	1993	1993	512025
TZ	125	1980	1980	480600
TZR R/ RR	125	1987	1987	480601
TZR R/ RR	125	1988	1988	480601
TZR R/ RR	125	1989	1990	480601
TZR R/ RR	125	1991	1991	480601
TZR R/ RR	125	1992	1992	480601
TZR R/ RR	125	1993	1993	480601
TZR R/ RR	125	1991	1991	512025
TZR R/ RR	125	1992	1992	512025
TZR R/ RR	125	1993	1993	512025
TZR R/ RR	125	1994	1994	512025
TZR R/ RR	125	1995	1995	512025
WR125 R	125	2009	2009	512127
WR125 R	125	2010	2010	512127
WR125 R	125	2011	2011	512127

				
Modèle	Cylindre	Année début	Année fin	Réf.
WR125 X	125	2009	2009	512127
WR125 X	125	2010	2010	512127
WR125 X	125	2011	2011	512127
WR125 R	125	2009	2009	512187
WR125 R	125	2010	2010	512187
WR125 R	125	2011	2011	512187
WR125 R	125	2012	2014	512187
XC VIRAGO	125	1997	1999	512005
XT	125	1982	1983	512004
XT X/ R	125	2005	2005	480608
XT X/ R	125	2006	2008	480608
XT X SUPERMOTARD	125	2005	2005	480608
XV VIRAGO	125	1997	1997	512005
XVS DRAG STAR	125	2000	2000	480625
XVS DRAG STAR	125	2001	2004	480625
YZF R	125	2008	2011	486027
YZF R	125	2012	2013	486027
RT	180	1990	1992	493902
RT	180	1993	1993	493902
TW	200	1987	1987	480601
TW	200	1988	1993	480601
TW	200	1994	1994	480601
TW	200	1995	1996	480601
TW	200	1997	2000	480601
TW	200	2001	2001	480601
TW	200	2002	2013	480601
TW	200	2014	2015	480601
TT	225	1986	1987	512011
XT	225	1992	1996	512011
TT-R	230	2005	2005	512011
TT-R	230	2006	2007	512011
TT-R	230	2008	2010	512011
TT-R	230	2011	2011	512011
TT-R	230	2012	2013	512011
TT-R	230	2014	2015	512011
SRSE/ G/ H/ TH	250	1980	1982	512004
SRSE/ G/ H/ TH	250	1993	1994	512004
TT-R	250	1999	1999	512029
TT-R	250	2000	2000	512029
TT-R	250	2001	2003	512029
TT-R	250	2004	2006	512029
TT-R	250	1999	1999	512125
TT-R	250	2000	2000	512125
TT-R	250	2001	2003	512125
TT-R	250	2004	2006	512125

MOTEUR

CYCLE

PNEUMATIQUE

ATELIER

ACCESSOIRES

ÉLECTRICITÉ

FILTRATION

FREINAGE

TRANSMISSION

ATHENA				
Modèle	Cylindre	Année début	Année fin	Réf.
TZ	250	1974	1974	512007
TZ	250	1976	1978	512008
TZ	250	1980	1982	512010
TZ	250	1993	1995	512024
TZ	250	1980	1982	512051
TZR	250	1987	1987	512021
TZR	250	1988	1988	512021
TZR	250	1989	1989	512021
TZR	250	1990	1992	512021
XT	250	1980	1980	512008
XT	250	1981	1982	512008
XT	250	1983	1983	512008
XT	250	1984	1984	480603
XV VIRAGO	250	1988	1988	512005
XV VIRAGO	250	1989	1989	512005
XV VIRAGO	250	1990	1992	512005
XV VIRAGO	250	1993	1993	512005
XV VIRAGO	250	1994	1994	512005
XV VIRAGO	250	1995	1995	512005
XV VIRAGO	250	1996	1997	512005
XV VIRAGO	250	1998	1998	512005
XV V STAR	250	2010	2010	493908
XV V STAR	250	2011	2011	493908
XV V STAR	250	2012	2013	493908
XVS DRAG STAR	250	2001	2001	480625
XVS DRAG STAR	250	2002	2004	480625
YTZ	250	1985	1985	493902
YTZ	250	1986	1986	512021
RD YPVS / LC / LCF	350	1980	1980	512003
RD YPVS / LC / LCF	350	1981	1982	512003
RD YPVS / LC / LCF	350	1973	1975	512007
RD YPVS / LC / LCF	350	1976	1976	512007
RD YPVS / LC / LCF	350	1983	1984	493902
RD YPVS / LC / LCF	350	1985	1985	493902
RD YPVS / LC / LCF	350	1986	1991	493902
RD YPVS / LC / LCF	350	1992	1993	493902
RD YPVS / LC / LCF	350	1994	1994	493902
RZ	350	1984	1985	493902
TT	350	1985	1985	512026
TT	350	1986	1987	512026
TT	350	1988	1989	512026
TT	350	1990	1994	512026
TT	350	1995	1995	512026
XT	350	1985	1993	480603
XT	350	1994	1996	480603

ATHENA				
Modèle	Cylindre	Année début	Année fin	Réf.
XT	350	1997	1998	480603
FZR	400	1988	1990	512016
FZR RR SP / RR	400	1991	1994	512030
SR	400	2015	2015	480625
SR E / F / G / SP	500	1978	1978	493902
SR E / F / G / SP	500	1979	1980	493902
SR E / F / G / SP	500	1981	1981	493902
SR E / F / G / SP	500	1982	1982	493902
TT	500	1976	1981	480603
XT	500	1973	1975	512007
XT	500	1976	1980	480603
XT	500	1981	1981	480603
XT	500	1982	1982	480603
XT	500	1983	1983	480603
XT	500	1984	1985	480603
XT	500	1986	1987	480603
XT	500	1988	1988	480603
XV VIRAGO	535	1987	1987	512011
XV VIRAGO	535	1988	1995	512011
XV VIRAGO	535	1996	1996	512011
XV VIRAGO	535	1997	1998	512011
FJ CHAIN DRIVE AC	600	1984	1985	512010
FJ CHAIN DRIVE AC	600	1984	1985	512051
FZ	600	1986	1986	512010
FZ	600	1987	1987	512010
FZ	600	1988	1988	512010
FZ	600	1986	1986	512051
FZ	600	1987	1987	512051
FZ	600	1988	1988	512051
FZ6 ABS	600	2004	2004	512177
FZ6 ABS	600	2005	2006	512177
FZ6 ABS	600	2007	2007	512177
FZ6 FAZER	600	2004	2004	512177
FZ6 FAZER	600	2005	2006	512177
FZ6 FAZER	600	2007	2007	512177
FZ6 FAZER	600	2008	2008	512177
FZ6 FAZER	600	2009	2009	512177
FZ6 FAZER ABS	600	2006	2006	512177
FZ6 FAZER ABS	600	2007	2007	512177
FZ6 FAZER S2	600	2007	2008	512177
FZ6 FAZER S2 ABS	600	2008	2008	512177
FZ6 S2 / ABS	600	2007	2008	512177
FZ6 ABS	600	2010	2011	480620
FZ6 ABS	600	2012	2015	480620
FZ6 ABS	600	2016	2018	480620

ATHENA				
Modèle	Cylindre	Année début	Année fin	Réf.
FZ6-N	600	2004	2004	512177
FZ6-N	600	2005	2008	512177
FZ6-NS	600	2005	2006	512177
FZ6-NS	600	2007	2008	512177
FZ6R	600	2012	2015	480620
FZ6-SA FAZER	600	2006	2006	512177
FZR	600	1989	1989	512016
FZR	600	1990	1990	512016
FZR	600	1991	1993	512016
FZR	600	1994	1996	512016
FZR R	600	1994	1995	512024
FZR R	600	1996	1998	512024
FZR	600	2012	2013	480620
FZR	600	2014	2016	480620
FZR	600	2017	2018	480620
FZS FAZER	600	2004	2007	512177
FZS FAZER	600	2002	2003	512187
SRX	600	1986	1987	512010
SRX	600	1988	1988	512010
SRX	600	1989	1989	512010
SRX	600	1986	1987	512051
SRX	600	1988	1988	512051
SRX	600	1989	1989	512051
TT E	600	1994	1995	512029
TT E	600	1996	1998	512029
TT E	600	1999	1999	512029
TT E	600	2000	2000	512029
TT E	600	2001	2001	512029
TT N	600	1989	1989	512029
TT N	600	1990	1992	512029
TT N	600	1993	1996	512029
TT N	600	1997	1997	512029
TT S	600	1993	1995	512029
TT S	600	1996	1996	512029
TT W	600	1989	1992	512029
TT N	600	1983	1983	512030
TT N	600	1984	1984	512030
TT N	600	1985	1987	512030
TT N	600	1988	1988	512030
TT N	600	1983	1983	486028
TT N	600	1984	1984	486028
TT N	600	1985	1987	486028
TT N	600	1988	1988	486028
TT N	600	1993	1996	512127
TT N	600	1997	1997	512127

ATHENA				
Modèle	Cylindre	Année début	Année fin	Réf.
XJ H/L/LC/N/NC	600	1984	1984	512010
XJ H/L/LC/N/NC	600	1985	1986	512010
XJ H/L/LC/N/NC	600	1987	1988	512010
XJ H/L/LC/N/NC	600	1989	1990	512010
XJ H/L/LC/N/NC	600	1991	1991	512010
XJ H/L/LC/N/NC	600	1992	1994	512016
XJ H/L/LC/N/NC	600	1995	1997	512016
XJ H/L/LC/N/NC	600	1998	1998	512016
XJ H/L/LC/N/NC	600	1984	1984	512051
XJ H/L/LC/N/NC	600	1985	1986	512051
XJ H/L/LC/N/NC	600	1987	1988	512051
XJ H/L/LC/N/NC	600	1989	1990	512051
XJ H/L/LC/N/NC	600	1991	1991	512051
XJ N/NSD/SE/SC/SH/SF/SJ/SG/SK SECA II	600	1997	2001	512147
XJ N/NSD/SE/SC/SH/SF/SJ/SG/SK SECA II	600	2002	2002	512147
XJ S DIVERSION / CHAIN DRIVE	600	1997	1997	512147
XJ S DIVERSION / CHAIN DRIVE	600	1998	1999	512147
XJ S DIVERSION / CHAIN DRIVE	600	2000	2002	512147
XJ N/NSD/SE/SC/SH/SF/SJ/SG/SK SECA II	600	2009	2009	480620
XJ S DIVERSION / CHAIN DRIVE	600	2009	2010	480620
XJ S DIVERSION / CHAIN DRIVE	600	2011	2015	480620
XJ6	600	2009	2011	480620
XJ6	600	2012	2013	480620
XJ6	600	2014	2015	480620
XT E	600	1995	2002	512024
XT L/LC/Z/ TENENRE' /T/S/N	600	1995	1997	512024
XT L/LC/Z/ TENENRE' /T/S/N	600	1998	1998	512024
XT L/LC/Z/ TENENRE' /T/S/N	600	1984	1985	512025
XT L/LC/Z/ TENENRE' /T/S/N	600	1986	1987	512025
XT L/LC/Z/ TENENRE' /T/S/N	600	1988	1989	512025
XT L/LC/Z/ TENENRE' /T/S/N	600	1990	1990	512025
XT L/LC/Z/ TENENRE' /T/S/N	600	1991	1991	512025
XT L/LC/Z/ TENENRE' /T/S/N	600	1992	1993	512025
XT U/UC/E/K TENERE	600	1995	1995	512025
XT U/UC/E/K TENERE	600	1996	1997	512025

MOTEUR

CYCLE

PNEUMATIQUE

ATELIER

ACCESSOIRES

ÉLECTRICITÉ

FILTRATION

FREINAGE

TRANSMISSION

ATHENA				
Modèle	Cylindre	Année début	Année fin	Réf.
XT U/ UC / E / K TENERE	600	1998	1998	512025
XT L / LC / Z / TENENRE' / T / S / N	600	1983	1983	512026
YXS / SC / T / TC	600	1986	1986	512010
YXS / SC / T / TC	600	1987	1987	512010
YXS / SC / T / TC	600	1988	1990	512010
YXS / SC / T / TC	600	1986	1986	512051
YXS / SC / T / TC	600	1987	1987	512051
YXS / SC / T / TC	600	1988	1990	512051
YZF R THUNDER CAT	600	1995	1995	512024
YZF R THUNDER CAT	600	1996	1998	512024
YZF R46	600	2005	2005	512187
YZF-R6	600	2017	2017	486028
YZF-R6	600	2018	2019	486028
YZF-R6	600	2016	2016	512187
YZF-R6	600	2006	2006	480620
YZF-R6	600	2007	2007	480620
YZF-R6	600	2008	2014	480620
YZF-R6	600	2015	2015	480620
XJ G / H / LH / RJ EUROPA	650	1980	1980	512010
XJ G / H / LH / RJ EUROPA	650	1981	1981	512010
XJ G / H / LH / RJ EUROPA	650	1982	1982	512010
XJ G / H / LH / RJ EUROPA	650	1983	1983	512010
XJ G / H / LH / RJ EUROPA	650	1984	1984	512010
XJ T / LJ / LK TURBO	650	1982	1983	512014
XJ G / H / LH / RJ EUROPA	650	1980	1980	512051
XJ G / H / LH / RJ EUROPA	650	1981	1981	512051
XJ G / H / LH / RJ EUROPA	650	1982	1982	512051
XJ G / H / LH / RJ EUROPA	650	1983	1983	512051
XJ G / H / LH / RJ EUROPA	650	1984	1984	512051
XVS	650	1997	1997	512024
XVS STAR CLASSIC / CUSTOM / SILVERADO	650	2002	2005	512147
XVS STAR CLASSIC / CUSTOM / SILVERADO	650	2006	2007	512147
XVS	650	1997	1997	512148
XVS	650	1998	1998	512148
XVS	650	1999	1999	512148
XVS	650	2000	2002	512148
XVS	650	2003	2006	512148

ATHENA				
Modèle	Cylindre	Année début	Année fin	Réf.
XVS	650	2007	2015	512148
XVS STAR CLASSIC / CUSTOM / SILVERADO	650	2006	2007	512187
XVS STAR CLASSIC / CUSTOM / SILVERADO	650	2008	2013	512187
XVS STAR CLASSIC / CUSTOM / SILVERADO	650	2014	2015	512187
XVS	650	1998	1998	512187
XVS	650	1999	1999	512187
XVS	650	2000	2002	512187
XVS	650	2003	2006	512187
MT-03	660	2006	2006	512029
MT-03	660	2007	2009	512029
MT-03	660	2010	2011	512029
MT-03	660	2006	2006	512127
MT-03	660	2007	2009	512127
MT-03	660	2010	2011	512127
SZR	660	1995	1995	512025
SZR	660	1996	1996	512025
SZR	660	1997	1997	512025
XT R / X	660	2004	2004	512029
XT R / X	660	2005	2010	512029
XT R / X	660	2011	2011	512029
XT R / X	660	2012	2012	512029
XTZ TENERE	660	2004	2007	512029
XTZ TENERE	660	2008	2010	512029
XTZ TENERE	660	1991	1994	512030
XTZ TENERE	660	2008	2010	512127
XTZ TENERE	660	2011	2011	512127
XTZ TENERE	660	2012	2012	512127
FZ	700	1985	1985	512020
FZ	700	1986	1986	512020
FZ	700	1987	1987	512020
FZ	700	1988	1992	512020
MT-07	700	2014	2015	512187
MT-07	700	2016	2017	512187
MT-07	700	2018	2019	512187
TRACER	700	2016	2018	512187
XV	700	1984	1987	512016
FZ	750	1985	1985	512020
FZ	750	1986	1986	512020
FZ	750	1987	1988	512020
FZ	750	1989	1990	512020
FZR	750	1987	1988	512024
FZR	750	1989	1992	512030
FZX FASER	750	1987	1987	512015

ATHENA				
Modèle	Cylindre	Année début	Année fin	Réf.
FZX FASER	750	1988	1988	512017
XTZ SUPER TENERE	750	1989	1992	512030
XTZ SUPER TENERE	750	1993	1995	512030
XV VIRAGO	750	1981	1983	512010
XV VIRAGO	750	1988	1991	512016
XV VIRAGO	750	1992	1993	512016
XV VIRAGO	750	1994	1996	512016
XV VIRAGO	750	1981	1983	512051
YZF SP / R	750	1993	1995	512024
YZF SP / R	750	1996	1996	512024
YZF SP / R	750	1997	1997	512024
YZF SP / R	750	1998	1998	512024
YZF R7 OW02	750	1999	2000	512177
FZ8	800	2011	2015	486028
FZ8	800	2011	2015	512125
FJ 09	850	2015	2015	512187
MT-09	850	2014	2015	512187
MT-09	850	2016	2017	512187
MT-09	850	2018	2019	512187
TDM	850	1991	1994	512025
TDM	850	1996	2000	512177
TDM	850	2001	2001	512177
TRX	850	1996	1997	512024
TDM A	900	2005	2006	486028
TDM	900	2002	2008	486028
TDM	900	2009	2010	486028
XJ S / DIVERSION	900	1983	1983	512014
XJ S / DIVERSION	900	1984	1984	512014
XJ S / DIVERSION	900	1985	1985	512014
XJ S / DIVERSION	900	1986	1992	512014
XJ S / DIVERSION	900	1995	1997	512024
BOLT	950	2014	2015	512187
XVS A MIDNIGHT STAR	950	2009	2015	512187
FZ1 FAZER (ABS	1000	2006	2008	486028
FZ1 FAZER (ABS	1000	2009	2010	486028
FZ1 FAZER (ABS	1000	2011	2013	486028
FZ1 FAZER (ABS	1000	2014	2015	486028
FZ1	1000	2006	2009	486028
FZ1	1000	2010	2010	486028
FZ1	1000	2011	2013	486028
FZ1	1000	2014	2015	486028
FZR GENESIS / EXUP / D / DC / E / EC	1000	1987	1988	512024
FZR GENESIS / EXUP / D / DC / E / EC	1000	1991	1991	512024

ATHENA				
Modèle	Cylindre	Année début	Année fin	Réf.
FZR GENESIS / EXUP / D / DC / E / EC	1000	1992	1993	512024
FZR GENESIS / EXUP / D / DC / E / EC	1000	1989	1989	512029
FZR GENESIS / EXUP / D / DC / E / EC	1000	1990	1990	512029
FZR GENESIS / EXUP / D / DC / E / EC	1000	1994	1994	512030
FZR GENESIS / EXUP / D / DC / E / EC	1000	1995	1995	512030
FZR GENESIS / EXUP / D / DC / E / EC	1000	1989	1989	486028
FZR GENESIS / EXUP / D / DC / E / EC	1000	1990	1990	486028
FZS FAZER	1000	2001	2003	512177
FZS FAZER	1000	2004	2005	512177
XV SE / VIRAGO	1000	1981	1981	512014
XV SE / VIRAGO	1000	1982	1982	512014
YZF R1	1000	2004	2004	486028
YZF R1	1000	2005	2005	486028
YZF R1	1000	2006	2006	486028
YZF R1	1000	2007	2008	486028
YZF R1	1000	2015	2017	486028
YZF R1	1000	2018	2019	486028
YZF R THUNDER ACE	1000	1996	1997	512148
YZF R THUNDER ACE	1000	1998	1998	512148
YZF R THUNDER ACE	1000	1999	2000	512148
YZF R1	1000	2009	2014	512177
YZF R1 SP / LIMITED EDITION	1000	2006	2006	512177
YZF R1	1000	2002	2003	512181
YZF R1	1000	1998	2001	512187
BT BULLDOG	1100	2002	2005	486028
BT BULLDOG	1100	2006	2006	486028
FJ	1100	1984	1985	512024
XV VIRAGO	1100	1986	1987	512016
XV VIRAGO	1100	1988	1988	512016
XV VIRAGO	1100	1989	1991	512016
XV VIRAGO	1100	1992	1992	512016
XV VIRAGO	1100	1993	1993	512016
XV VIRAGO	1100	1994	1996	512016
XV VIRAGO	1100	1997	1998	512016
XVS DRAG STAR	1100	2000	2000	512147
XVS DRAG STAR	1100	2001	2002	512147
XVS DRAG STAR	1100	2003	2003	512147
XVS DRAG STAR / A CLASSIC	1100	2000	2000	512187
XVS DRAG STAR / A CLASSIC	1100	2001	2002	512187

ATHENA				
Modèle	Cylindre	Année début	Année fin	Réf.
XVS DRAG STAR / A CLASSIC	1100	2003	2006	512187
FJ ABS	1200	1984	1985	512024
FJ ABS	1200	1986	1987	512024
FJ ABS	1200	1988	1988	512024
FJ ABS	1200	1989	1990	512024
FJ ABS	1200	1991	1991	512024
FJ ABS	1200	1992	1992	512024
FJ ABS	1200	1993	1993	512024
V-MAX	1200	1985	1985	512022
V-MAX	1200	1986	1989	512022
V-MAX	1200	1990	1992	512022
V-MAX	1200	1993	1995	512022
V-MAX	1200	1996	1997	512029
V-MAX	1200	1998	1998	512029
V-MAX	1200	1999	1999	512029
V-MAX	1200	2000	2001	512029
V-MAX	1200	1996	1997	486028
V-MAX	1200	1998	1998	486028
V-MAX	1200	1999	1999	486028
V-MAX	1200	2000	2001	486028
XJR SP	1200	1995	1995	512029
XJR SP	1200	1996	1996	512029
XJR SP	1200	1997	1997	512029
XJR SP	1200	1995	1995	486028
XJR SP	1200	1996	1996	486028
XJR SP	1200	1997	1997	486028
XTZ SUPER TENERE	1200	2010	2013	512029
XTZ SUPER TENERE - M.Y.2014	1200	2014	2019	486028
XTZ SUPER TENERE	1200	2010	2013	512127
FJR A	1300	2003	2005	512147
FJR A	1300	2006	2006	512147
FJR AS	1300	2006	2006	512147
FJR	1300	2001	2004	512147
FJR	1300	2005	2009	512147
FJR	1300	2010	2010	512147
FJR	1300	2011	2012	512147
FJR	1300	2013	2015	512147
FJR A	1300	2016	2016	512148
FJR ABS	1300	2003	2004	512148
FJR ABS	1300	2005	2005	512148
FJR ABS	1300	2006	2006	512148
FJR ABS	1300	2007	2010	512148
FJR ABS	1300	2011	2011	512148
FJR ABS	1300	2012	2012	512148

ATHENA				
Modèle	Cylindre	Année début	Année fin	Réf.
FJR ABS	1300	2013	2013	512148
FJR ABS	1300	2014	2016	512148
FJR AS	1300	2006	2006	512148
FJR AS	1300	2007	2008	512148
FJR	1300	2001	2004	512148
XJR SP	1300	2002	2006	486028
XJR SP	1300	2007	2011	486028
XJR SP	1300	2012	2015	486028
XVS V STAR / V STAR TOURER	1300	2007	2010	512187
XVS V STAR / V STAR TOURER	1300	2011	2012	512187
XVS STRYKER	1300	2011	2012	486028
XVZ 13 T	1300	1987	1987	512022
XVZ 13 VENTURE / VENTURE ROYALE	1300	1986	1989	512022
XVZ 13 VENTURE / VENTURE ROYALE	1300	1990	1992	512022
XVZ 13 VENTURE / VENTURE ROYALE	1300	1993	1993	512022
XVZ 13 VENTURE / VENTURE ROYALE	1300	1996	1998	512028
XVZ 13 VENTURE / VENTURE ROYALE	1300	1996	1998	512120
XVZ 13 CT/ CTS ROYAL STAR TUOR DELUXE / S	1300	1996	2000	512178
XVZ ROYAL STAR	1300	1996	2000	512178
XVZ ROYAL STAR VENTURE	1300	2000	2000	512178
XVZ ROYAL STAR VENTURE	1300	2001	2011	512178
XV A WILD STAR	1600	1999	2002	512178
MT-01	1700	2005	2006	512177
MT-01	1700	2007	2007	512177
MT-01	1700	2008	2009	512177
XV	1700	2003	2012	512178
XV WARRIOR	1700	2003	2004	512187
XV WARRIOR	1700	2005	2010	512187



/ JOINT MAXI-SCOOTER

				
Modèle	Cylindre	Année début	Année fin	Réf.
APRILIA				
ATLANTIC	125	2003	2003	493905
ATLANTIC	125	2004	2004	493905
ATLANTIC	125	2005	2005	493905
ATLANTIC	125	2006	2006	493905
ATLANTIC	125	2007	2008	493905
ATLANTIC	125	2009	2011	493905
ATLANTIC	125	2003	2003	493902
ATLANTIC	125	2004	2004	493902
ATLANTIC	125	2005	2005	493902
ATLANTIC	125	2006	2006	493902
ATLANTIC	125	2007	2008	493902
ATLANTIC	125	2009	2011	493902
ATLANTIC EU3	125	2003	2005	512188
ATLANTIC EU3	125	2006	2008	512188
ATLANTIC	125	2003	2003	512188
ATLANTIC	125	2004	2004	512188
ATLANTIC	125	2005	2005	512188
ATLANTIC	125	2006	2006	512188
ATLANTIC	125	2003	2003	512190
ATLANTIC	125	2004	2004	512190
ATLANTIC	125	2005	2005	512190
ATLANTIC	125	2006	2006	512190
ATLANTIC	125	2007	2008	512190
ATLANTIC	125	2009	2011	512190
LEONARDO ST	125	2001	2001	493902
LEONARDO ST	125	2002	2004	493902
LEONARDO 4T	125	1996	1996	512033
LEONARDO 4T	125	1997	1997	512033
LEONARDO 4T	125	1998	1998	512033
LEONARDO 4T	125	1999	1999	512033
LEONARDO 4T	125	2000	2001	512033
SCARABEO MOTORE PIAGGIO	125	2003	2003	493902
SCARABEO MOTORE PIAGGIO	125	2004	2004	493902
SCARABEO MOTORE PIAGGIO	125	2005	2006	493902
SCARABEO MOTORE ROTAX	125	1999	2004	493902
SCARABEO MOTORE PIAGGIO	125	2003	2003	512188
SCARABEO MOTORE PIAGGIO	125	2004	2004	512188
SCARABEO MOTORE PIAGGIO	125	2005	2006	512188

				
Modèle	Cylindre	Année début	Année fin	Réf.
SCARABEO MOTORE ROTAX	125	1999	2004	512188
SCARABEO MOTORE PIAGGIO	125	2003	2003	512190
SCARABEO MOTORE PIAGGIO	125	2004	2004	512190
SCARABEO MOTORE PIAGGIO	125	2005	2006	512190
SCARABEO MOTORE ROTAX	125	1999	2004	512190
SPORT CITY	125	2004	2004	512190
SPORT CITY	125	2005	2005	512190
SPORT CITY	125	2006	2006	512190
SPORT CITY CUBE	125	2008	2008	512190
SPORT CITY CUBE	125	2009	2009	512190
SPORT CITY CUBE	125	2010	2010	512190
SPORT CITY EU3	125	2007	2007	512190
SPORT CITY EU3	125	2008	2008	512190
SPORT CITY EU3	125	2008	2008	512196
SPORT CITY EU3	125	2009	2011	512196
SPORT CITY ONE	125	2008	2010	512200
SR	125	1999	2001	480599
SR MAX	125	2011	2011	493906
SR SPORT CITY	125	2006	2006	512190
LEONARDO ST	150	2001	2001	493902
LEONARDO ST	150	2002	2004	493902
LEONARDO 4T	150	1996	1996	512033
LEONARDO 4T	150	1997	1998	512033
LEONARDO 4T	150	1999	1999	512033
LEONARDO 4T	150	2000	2001	512033
SCARABEO MOT. ROTAX	150	1999	2003	493905
ATLANTIC 4T LC	200	2003	2003	493905
ATLANTIC 4T LC	200	2004	2004	493905
ATLANTIC 4T LC	200	2005	2005	493905
ATLANTIC 4T LC	200	2006	2006	493905
ATLANTIC 4T LC	200	2003	2003	493902
ATLANTIC 4T LC	200	2004	2004	493902
ATLANTIC 4T LC	200	2005	2005	493902
ATLANTIC 4T LC	200	2006	2006	493902
ATLANTIC 4T LC	200	2003	2003	512190
ATLANTIC 4T LC	200	2004	2004	512190
ATLANTIC 4T LC	200	2005	2005	512190
ATLANTIC 4T LC	200	2006	2006	512190
SCARABEO MOTORE PIAGGIO	200	2003	2006	493902
SCARABEO MOTORE ROTAX	200	1999	2004	493902

MOTEUR

CYCLE

PNEUMATIQUE

ATELIER

ACCESSOIRES

ÉLECTRICITÉ

FILTRATION

FREINAGE

TRANSMISSION

JOINT SPI MAXI SCOOTER / MAXI SCOOTER FORK OIL SEAL

MOTEUR

CYCLE

PNEUMATIQUE

ATELIER

ACCESSOIRES

ÉLECTRICITÉ

FILTRATION

FREINAGE

TRANSMISSION



Modèle	Cylindre	Année début	Année fin	Réf.
SCARABEO MOTORE PIAGGIO	200	2003	2006	512188
SCARABEO MOTORE ROTAX	200	1999	2004	512188
SCARABEO MOTORE PIAGGIO	200	2003	2006	512190
SCARABEO MOTORE ROTAX	200	1999	2004	512190
SPORT CITY	200	2006	2006	512190
SPORT CITY	200	2007	2008	512190
SPORT CITY CUBE	200	2008	2008	512190
SPORT CITY CUBE	200	2009	2010	512190
ATLANTIC	250	2003	2005	493905
ATLANTIC	250	2006	2008	493905
ATLANTIC	250	2009	2009	493905
ATLANTIC	250	2003	2005	493902
ATLANTIC	250	2006	2008	493902
ATLANTIC	250	2009	2009	493902
ATLANTIC	250	2003	2005	512190
ATLANTIC	250	2006	2008	512190
ATLANTIC	250	2009	2009	512190
LEONARDO	250	1999	1999	493905
LEONARDO	250	2000	2001	493905
LEONARDO	250	2002	2002	493905
LEONARDO	250	2003	2004	493905
LEONARDO	250	1999	1999	493902
LEONARDO	250	2000	2001	493902
LEONARDO	250	2002	2002	493902
LEONARDO	250	2003	2004	493902
SCARABEO LIGHT	250	2006	2008	512190
SPORT CITY	250	2006	2007	512190
SPORT CITY	250	2008	2008	512190
SPORT CITY CUBE	250	2008	2010	512190
ATLANTIC	300	2010	2010	493905
ATLANTIC	300	2011	2011	493905
ATLANTIC	300	2010	2010	493902
ATLANTIC	300	2011	2011	493902
ATLANTIC	300	2010	2010	512190
ATLANTIC	300	2011	2011	512190
LEONARDO	300	1999	2001	493905
LEONARDO	300	2002	2004	493905
LEONARDO	300	1999	2001	493902
LEONARDO	300	2002	2004	493902
SCARABEO LIGHT	300	2009	2010	512190
SPORT CITY	300	2006	2006	512190
SPORT CITY CUBE	300	2008	2010	512190
SR MAX	300	2011	2011	493906

Modèle	Cylindre	Année début	Année fin	Réf.
ATLANTIC SPRINT	400	2005	2006	493905
ATLANTIC SPRINT	400	2007	2007	493905
ATLANTIC SPRINT	400	2008	2008	493905
ATLANTIC SPRINT	400	2005	2006	493902
ATLANTIC SPRINT	400	2007	2007	493902
ATLANTIC SPRINT	400	2008	2008	493902
ATLANTIC SPRINT	400	2005	2006	480623
ATLANTIC SPRINT	400	2007	2007	480623
ATLANTIC SPRINT	400	2005	2006	512190
ATLANTIC SPRINT	400	2007	2007	512190
ATLANTIC SPRINT	400	2008	2008	512190
ATLANTIC SPRINT	500	2005	2005	493905
ATLANTIC SPRINT	500	2006	2006	493905
ATLANTIC SPRINT	500	2007	2007	493905
ATLANTIC SPRINT	500	2008	2008	493905
ATLANTIC SPRINT	500	2005	2005	493902
ATLANTIC SPRINT	500	2006	2006	493902
ATLANTIC SPRINT	500	2007	2007	493902
ATLANTIC SPRINT	500	2008	2008	493902
ATLANTIC	500	2001	2001	480623
ATLANTIC	500	2002	2004	480623
ATLANTIC SPRINT	500	2005	2005	512190
ATLANTIC SPRINT	500	2006	2006	512190
ATLANTIC SPRINT	500	2007	2007	512190
ATLANTIC SPRINT	500	2008	2008	512190
SCARABEO	500	2003	2003	480623
SCARABEO	500	2004	2004	480623
SCARABEO	500	2005	2006	480623
SRV	850	2012	2012	512187
SRV	850	2013	2014	512187
BETA				
EIKON	125	2000	2002	512033
EIKON	150	2000	2002	512033
BMW				
C SPORT	600	2013	2015	486025
C SPORT	600	2013	2015	485241
C GT	650	2013	2015	486025
C GT	650	2013	2015	485241
C GT	650	2016	2017	485241
DERBI				
BOULEVARD EU3	125	2008	2012	512196
BOULEVARD EU3	125	2008	2012	512200
GPI EU2	125	2006	2006	486025
GP1	125	2006	2006	486025
MULHACEN 4T EU3	125	2010	2018	480622

ATHENA				
Modèle	Cylindre	Année début	Année fin	Réf.
RAMBLA	125	2008	2008	512190
VARIANT SPORT 4T E3	125	2012	2012	493907
VARIANT SPORT 4T E3	125	2013	2018	493907
BOULEVARD EU3	150	2010	2010	512196
GP1	250	2006	2006	486025
RAMBLA	250	2008	2008	512190
RAMBLA	300	2010	2010	512190
GILERA				
NEXUS EURO 3	125	2007	2007	493906
NEXUS EURO 3	125	2008	2008	493906
RUNNER FX LC	125	1997	1999	480618
RUNNER FX LC	125	2000	2000	480618
RUNNER FX LC	125	2001	2002	480618
RUNNER SP FX	125	1997	1999	480618
RUNNER SP FX	125	2000	2000	480618
RUNNER SP FX	125	2001	2001	480618
RUNNER SP FX	125	2002	2002	480618
RUNNER VX-VXR 4T LC	125	2000	2000	480618
RUNNER VX-VXR 4T LC	125	2001	2001	480618
RUNNER VX-VXR 4T LC	125	2002	2002	480618
RUNNER VX-VXR 4T LC	125	2003	2004	480618
RUNNER 4T ST EURO3	125	2008	2012	493906
RUNNER 4T ST EURO3	125	2013	2014	493906
RUNNER VX 4T ST EURO3	125	2008	2010	493906
RUNNER VX EU3 4T	125	2005	2006	493906
RUNNER VX EU3 4T	125	2007	2007	493906
RUNNER VX RACE 4T	125	2006	2006	493906
RUNNER VX SC 4T	125	2005	2005	493906
RUNNER VX SC 4T	125	2006	2006	493906
RUNNER VX SC 4T	125	2007	2007	493906
RUNNER FX LC	125	1997	1999	480621
RUNNER FX LC	125	2000	2000	480621
RUNNER FX LC	125	2001	2002	480621
TYPHOON X/XR	125	1999	1999	480606
TYPHOON X/XR	125	2000	2000	480606
TYPHOON X/XR	125	2001	2001	480606
TYPHOON	125	1995	1995	480606
TYPHOON	125	1996	1996	480606
TYPHOON	125	1997	1998	480606
RUNNER VX-VXR 4T	180	2000	2000	480618
RUNNER VX-VXR 4T	180	2001	2001	480618
RUNNER VX-VXR 4T	180	2002	2004	480618
RUNNER VX-VXR 4T	200	2000	2000	480618
RUNNER VX-VXR 4T	200	2001	2001	480618
RUNNER VX-VXR 4T	200	2002	2002	480618
RUNNER VX-VXR 4T	200	2003	2004	480618

ATHENA				
Modèle	Cylindre	Année début	Année fin	Réf.
RUNNER VXR EU3	200	2005	2007	493906
RUNNER VXR RACE 4T	200	2005	2005	493906
RUNNER VXR RACE 4T	200	2006	2006	493906
RUNNER VXR ST EURO3 4T	200	2008	2008	493906
RUNNER VXR ST EURO3 4T	200	2009	2009	493906
NEXUS EU3	250	2006	2007	493906
NEXUS SP EU3	250	2006	2007	493906
NEXUS	300	2008	2009	493906
NEXUS EU3	500	2009	2009	512187
NEXUS EU3	500	2010	2011	512187
NEXUS SP EURO 3	500	2003	2005	512187
NEXUS SP EURO 3	500	2006	2007	512187
NEXUS SP EURO 3	500	2008	2009	512187
NEXUS	500	2003	2003	512187
NEXUS	500	2004	2004	512187
NEXUS	500	2005	2005	512187
NEXUS	500	2006	2006	512187
NEXUS	500	2007	2009	512187
GP	800	2008	2009	512187
GP	800	2010	2010	512187
HONDA				
ATC	185	1983	1983	493904
ATC BIG RED / X / S	200	1983	1983	493904
ATC BIG RED / X / S	200	1984	1985	493904
ATC BIG RED / X / S	200	1986	1986	493904
ATC BIG RED / X / S	200	1984	1985	512006
ATC BIG RED / X / S	200	1986	1986	512006
ATC BIG RED / X / S	200	1987	1987	512006
ATC R	250	1981	1981	493904
ATC R	250	1982	1982	493904
ATC ES BIG RED / SX	250	1985	1987	512006
ATC R	250	1983	1984	493902
ATC R	250	1985	1986	512021
ATC X	350	1985	1985	493902
ATC X	350	1986	1986	493902
@ NES LC	125	2001	2001	493908
@ NES LC	125	2002	2002	493908
@ NES LC	125	2003	2004	493908
@ NES LC	125	2005	2005	493908
FES S-WING	125	2007	2007	512170
FES S-WING	125	2008	2010	512170
FORZA	125	2015	2015	512170
PANTHEON LC	125	1998	1998	480602
PANTHEON LC	125	1998	1998	512170

JOINT SPI MAXI SCOOTER / MAXI SCOOTER FORK OIL SEAL



MOTEUR

CYCLE

PNEUMATIQUE

ATELIER

ACCESSOIRES

ÉLECTRICITÉ

FILTRATION

FREINAGE

TRANSMISSION

ATHENA				
Modèle	Cylindre	Année début	Année fin	Réf.
PANTHEON LC	125	1999	2001	512170
PCX	125	2010	2011	486026
PCX	125	2012	2013	486026
PCX	125	2014	2014	486026
PCX	125	2015	2015	486026
PCX	125	2016	2017	486026
PCX	125	2018	2018	486026
PCX	125	2019	2019	486026
PES INJECTION / PS	125	2006	2006	512170
PES INJECTION / PS	125	2007	2007	512170
PES INJECTION / PS	125	2008	2009	512170
PES INJECTION / PS	125	2010	2010	512170
SH MODE ANC	125	2014	2015	486026
SH i	125	2005	2008	512170
SH i	125	2009	2010	512170
SH i	125	2011	2012	512170
SH i	125	2013	2014	512170
SH i	125	2015	2016	512170
SH i	125	2017	2018	512170
SH i	125	2019	2019	512170
SH i	125	2020	2020	512170
SH i	125	2001	2001	493908
SH i	125	2002	2004	493908
@ NES LC	150	2001	2001	493908
@ NES LC	150	2002	2004	493908
@ NES LC	150	2005	2005	493908
FES S-WING	150	2007	2009	512170
FES S-WING	150	2007	2009	493908
PANTHEON LC	150	1998	1998	512170
PANTHEON LC	150	1999	2001	512170
PCX	150	2012	2013	486026
PCX	150	2014	2014	486026
PES INJECTION	150	2006	2006	512170
PES INJECTION	150	2007	2007	512170
PES INJECTION	150	2008	2010	512170
PES INJECTION	150	2006	2006	493908
PES INJECTION	150	2007	2007	493908
PES INJECTION	150	2008	2010	493908
SH i	150	2005	2008	512170
SH i	150	2009	2010	512170
SH i	150	2011	2012	512170
SH i	150	2013	2014	512170
SH i	150	2015	2016	512170
SH i	150	2017	2018	512170
SH i	150	2019	2019	512170
SH i	150	2020	2020	512170

ATHENA				
Modèle	Cylindre	Année début	Année fin	Réf.
SH i	150	2001	2001	493908
SH i	150	2002	2002	493908
SH i	150	2003	2004	493908
FORZA NSS	250	2008	2009	512190
FORZA I.E	300	2018	2018	512170
FORZA I.E	300	2019	2020	512170
SH ABS	300	2007	2007	493902
SH ABS	300	2008	2012	493902
SH ABS	300	2013	2013	493902
SH ABS	300	2014	2014	493902
SH ABS	300	2015	2017	493902
SH ABS	300	2018	2018	493902
SH ABS	300	2019	2020	493902
SH ABS	300	2007	2007	512195
SH ABS	300	2008	2012	512195
SH ABS	300	2013	2013	512195
SH ABS	300	2014	2014	512195
SH ABS	300	2015	2017	512195
SH ABS	300	2018	2018	512195
SH ABS	300	2019	2020	512195
SILVER WING / SW-T	400	2006	2008	512174
SILVER WING / SW-T	400	2009	2015	512174
SILVERWING FJS / FSC	600	2002	2008	512174
SILVERWING FJS / FSC	600	2009	2009	512174
SILVERWING FJS / FSC	600	2010	2012	512174
SILVERWING FJS / FSC	600	2013	2013	512174
NC700 INTEGRA / X	700	2012	2012	512026
NC700 INTEGRA / X	700	2013	2013	512026
NC700 INTEGRA / X	700	2014	2015	512026
NC700 INTEGRA / X	700	2016	2017	512026
NC700 INTEGRA / X	700	2018	2018	512026
NC700 INTEGRA / X	700	2019	2019	512026
NC700 INTEGRA / X	700	2012	2012	512192
NC700 INTEGRA / X	700	2013	2013	512192
NC700 INTEGRA / X	700	2014	2015	512192
NC700 INTEGRA / X	700	2016	2017	512192
KAWASAKI				
KLT AI	160	1985	1985	493904
KLT	185	1986	1987	493904
KYMCO				
AGILITY CARRY	125	2011	2011	486026
AGILITY CARRY	125	2017	2017	486026
AGILITY PLUS	125	2014	2014	480602
AGILITY PLUS	125	2016	2016	480602
AGILITY R16	125	2008	2008	480602
AGILITY R16	125	2009	2009	480602



JOINT SPI MAXI SCOOTER / MAXI SCOOTER FORK OIL SEAL

MOTEUR

CYCLE

PNEUMATIQUE

ATELIER

ACCESSOIRES

ÉLECTRICITÉ

FILTRATION

FREINAGE

TRANSMISSION

ATHENA				
Modèle	Cylindre	Année début	Année fin	Réf.
AGILITY R16	125	2012	2012	480602
B&W 4T LC	125	2000	2000	480602
B&W 4T LC	125	2001	2004	480602
DINK CLASSIC / EURO2	125	2002	2002	480602
DINK CLASSIC / EURO2	125	2003	2003	480602
DINK EURO 3	125	2006	2007	480602
DOWNTOWN	125	2009	2009	512199
DOWNTOWN	125	2010	2016	512199
G-DINK	125	2012	2012	512207
G-DINK	125	2013	2018	512207
GRAND DINK / EURO2	125	2001	2001	480602
GRAND DINK / EURO2	125	2002	2002	480602
GRAND DINK / EURO2	125	2003	2004	480602
K-XCT I	125	2012	2013	512199
K-XCT I	125	2014	2014	512199
LIKE LX	125	2012	2012	486026
LIKE	125	2009	2009	486026
MOVIE EURO 3	125	2006	2007	480602
MOVIE XL 4T	125	2003	2004	480602
PEOPLE EURO2	125	2011	2011	486026
PEOPLE ONE	125	2016	2016	480602
SUPER DINK	125	2009	2009	512199
SUPER DINK	125	2010	2016	512199
VIVIO	125	2000	2000	486026
AGILITY R16	150	2008	2009	480602
B&W 4T LC	150	2000	2000	480602
DINK CLASSIC / EURO2	150	2002	2002	480602
DINK CLASSIC / EURO2	150	2003	2003	480602
GRAND DINK / EURO2	150	2001	2001	480602
GRAND DINK / EURO2	150	2002	2002	480602
GRAND DINK / EURO2	150	2003	2004	480602
MOVIE EURO 3	150	2006	2007	480602
MOVIE XL 4T	150	2003	2004	480602
VIVIO	150	2000	2000	486026
AGILITY I PLUS	200	2014	2014	480602
AGILITY I R16	200	2010	2010	480602
AGILITY I R16	200	2012	2012	480602
AGILITY I R16	200	2019	2019	480602
DINK EU3 I	200	2006	2007	480602
DOWNTOWN I	200	2010	2010	512199
DOWNTOWN I	200	2011	2012	512199
DOWNTOWN I	200	2013	2018	512199
B&W	250	2000	2000	480602
B&W	250	2001	2001	480602
B&W	250	2002	2003	480602
GRAND DINK	250	2001	2002	480602

ATHENA				
Modèle	Cylindre	Année début	Année fin	Réf.
GRAND DINK	250	2003	2004	480602
PEOPLE 4T	250	2003	2003	512199
PEOPLE 4T	250	2004	2004	512199
PEOPLE S/ S i	250	2006	2006	512199
PEOPLE S/ S i	250	2007	2007	512199
X CITING/ X CITING i	250	2005	2005	512198
X CITING/ X CITING i	250	2006	2006	512198
X CITING/ X CITING i	250	2007	2007	512198
DOWNTOWN ABS	300	2009	2009	512199
DOWNTOWN ABS	300	2010	2010	512199
DOWNTOWN ABS	300	2011	2012	512199
G-DINK	300	2012	2012	512207
G-DINK	300	2013	2018	512207
K-XCT I	300	2014	2014	512199
K-XCT I	300	2015	2018	512199
PEOPLE GTi	300	2010	2010	512199
PEOPLE GTi	300	2011	2011	512199
PEOPLE SI	300	2008	2018	512199
X CITING I / R	300	2008	2009	512198
DOWNTOWN I	350	2015	2015	512199
DOWNTOWN I	350	2016	2016	512199
X-CITING I / R	500	2005	2009	512198
MALAGUTI				
CIAK MASTER	125	2004	2004	480605
CIAK MASTER	125	2005	2006	480605
CIAK 4T	125	1999	1999	480609
CIAK 4T	125	2000	2001	480609
F18 WARRIOR	125	2000	2000	480609
F18 WARRIOR	125	2001	2001	480609
F18 WARRIOR	125	2002	2002	480609
MADISON 4T LC	125	1999	1999	480608
MADISON 4T LC	125	2000	2001	480608
MADISON 4T LC	125	2002	2004	480608
MADISON R RESTYLING	125	1999	2001	480608
MADISON R RESTYLING	125	2002	2002	480608
MADISON R RESTYLING	125	2003	2004	480608
PHANTOM MAX	125	2003	2003	480609
CIAK MASTER	150	2000	2003	480609
CIAK MASTER	150	2004	2004	480609
F18 WARRIOR	150	2000	2000	480609
F18 WARRIOR	150	2001	2001	480609
F18 WARRIOR	150	2002	2002	480609
MADISON T 4T LC	150	1999	1999	480608
MADISON T 4T LC	150	2000	2000	480608
MADISON T 4T LC	150	2001	2001	480608
MADISON R 4T LC	180	2001	2001	480608

				
Modèle	Cylindre	Année début	Année fin	Réf.
MADISON R 4T LC	180	2002	2002	480608
CIAK MASTER	200	2006	2006	480605
MADISON MASTER EU2	200	2003	2003	480608
MADISON S RESTYLING/ EU2	200	2003	2003	480608
PHANTOM MAX	200	2003	2003	480609
MADISON R RESTYLING	250	1999	2004	480608
MADISON RS	250	1999	2004	480608
MADISON S 4T	250	1999	1999	480608
MADISON S 4T	250	2000	2000	480608
MADISON S 4T	250	2001	2001	480608
MADISON S 4T	250	2002	2004	480608
PHANTOM MAX	250	2004	2004	480609
MADISON K / RESTYLING	400	2002	2002	480608
MADISON K / RESTYLING	400	2003	2004	480608
MBK				
XC T FLAME / K FLAME R 4T	125	1997	1998	480600
XC T FLAME / K FLAME R 4T	125	1999	1999	480600
XC T FLAME / K FLAME R 4T	125	2000	2000	480600
XC T FLAME / K FLAME R 4T	125	2001	2001	480600
XN DOODO 4T LC	125	2000	2000	512005
XN DOODO 4T LC	125	2001	2001	512005
YP SKYLINER 4T	125	1998	1998	480601
YP SKYLINER 4T	125	1999	2000	480601
YP SKYLINER 4T	125	2001	2001	480601
YP SKYLINER 4T	125	2003	2003	480609
XC VERTEX	150	1997	1997	480600
XN DOODO 4T LC	150	2001	2001	512005
XN DOODO 4T LC	150	2002	2002	512005
YP SKYLINER 4T	150	2000	2000	480601
YP SKYLINER 4T	150	2001	2001	480601
YP SKYLINER 4T	150	2002	2002	480601
YP SKYLINER 4T	150	2001	2001	480609
YP SKYLINER 4T	150	2002	2002	480609
YP E SKYLINER	180	2003	2003	480609
YP SKYLINER 4T	250	2000	2000	493908
YP SKYLINER 4T	250	2001	2001	493908
YP SKYLINER 4T	250	2002	2003	493908
XC KILIBRE	300	2003	2003	512175
PEUGEOT				
ELYSEO 4T LC	125	2001	2001	480608
ELYSTAR	125	2002	2002	480609
ELYSTAR	125	2003	2003	480609

				
Modèle	Cylindre	Année début	Année fin	Réf.
JET FORCE COMPRESSOR	125	2003	2004	480608
LOOXOR	125	2002	2002	480609
LOOXOR	125	2003	2003	480609
ELYSEO 4T LC	150	2001	2001	480608
ELYSTAR	150	2002	2002	480608
ELYSTAR	150	2003	2003	480608
LOOXOR	150	2002	2003	480609
PIAGGIO				
BEVERLY MIC EU3	125	2007	2007	493906
BEVERLY RST	125	2004	2005	493906
BEVERLY RST	125	2006	2007	493906
BEVERLY RST 4T 4V IE EURO3	125	2010	2011	493906
BEVERLY RST 4T 4V IE EURO3	125	2012	2012	493906
BEVERLY RST 4T 4V IE EURO3	125	2013	2013	493906
BEVERLY RST 4T 4V IE EURO3	125	2014	2015	493906
BEVERLY SPORT EU3	125	2007	2007	493906
BEVERLY SPORT EU3	125	2008	2008	493906
BEVERLY TOURER EU3	125	2008	2009	493906
BEVERLY TOURER EU3	125	2010	2010	493906
BEVERLY	125	2001	2001	493906
BEVERLY	125	2002	2002	493906
BEVERLY	125	2003	2003	493906
BEVERLY	125	2004	2006	493906
BEVERLY	125	2007	2007	493906
CARNABY	125	2007	2007	493906
CARNABY	125	2008	2009	493906
CARNABY	125	2010	2010	493906
FLY EU3	125	2007	2008	512196
FLY EU3	125	2009	2011	512196
FLY EU3	125	2007	2008	512200
FLY EU3	125	2009	2011	512200
LIBERTY 4T	125	1998	1998	512131
LIBERTY 4T	125	1999	2000	512131
LIBERTY 4T (LEADER E.G	125	2000	2001	512131
LIBERTY 4T 3V	125	2013	2014	512200
LIBERTY 4T 3V	125	2015	2015	512200
LIBERTY MOC 4T	125	2009	2010	512200
LIBERTY MOC 4T	125	2011	2012	512200
LIBERTY MOC 4T	125	2013	2013	512200
SKIPPER 2T / LX	125	1998	1998	480606
SKIPPER 2T / LX	125	1999	1999	480606
SKIPPER 4T	125	2000	2000	480621

ATHENA				
Modèle	Cylindre	Année début	Année fin	Réf.
SKIPPER 4T	125	2001	2002	480621
SUPER HEXAGON GTX 4T	125	2001	2001	493906
SUPER HEXAGON GTX 4T	125	2002	2002	493906
X EVO	125	2007	2007	493906
X EVO	125	2008	2012	493906
X EVO	125	2013	2016	493906
X7 EU3	125	2008	2008	493906
X7 EU3	125	2009	2009	493906
X7 EVO IE EURO3	125	2009	2010	493906
X8 PREMIUM EU2/EU3	125	2006	2006	493906
X8 PREMIUM EU2/EU3	125	2007	2007	493906
X8 STREET EURO 2	125	2006	2006	493906
X8 STREET EURO 2	125	2007	2007	493906
X8 STREET EURO 2	125	2008	2008	493906
X8	125	2004	2004	493906
X8	125	2005	2005	493906
X8	125	2006	2006	493906
X9 4T	125	2001	2001	493906
X9 4T	125	2002	2002	493906
X9 EVOLUTION EU3	125	2003	2003	493906
X9 EVOLUTION EU3	125	2004	2004	493906
X9 EVOLUTION EU3	125	2005	2005	493906
X9 EVOLUTION EU3	125	2006	2006	493906
X9 EVOLUTION EU3	125	2007	2007	493906
ZIP	125	2000	2000	493907
ZIP	125	2001	2002	493907
FLY EURO3	150	2008	2010	512196
FLY EURO3	150	2011	2011	512196
LIBERTY 4T (LEADER E.G	150	2000	2001	512131
LIBERTY 4T - 3V LEM	150	2013	2014	512200
LIBERTY MOC 4T	150	2009	2013	512200
SKIPPER 2T / LX	150	1998	1999	480606
SKIPPER 4T	150	2001	2002	480606
X9 AMALFI 4T LC	180	2000	2001	493906
X9 AMALFI 4T LC	180	2002	2002	493906
X9 AMALFI 4T LC	180	2003	2003	493906
BEVERLY 4T	200	2001	2001	493906
BEVERLY 4T	200	2002	2003	493906
CARNABY	200	2007	2007	493906
CARNABY	200	2008	2008	493906
X8	200	2004	2004	493906
X8	200	2005	2005	493906
X8	200	2006	2006	493906
X8	200	2007	2007	493906

ATHENA				
Modèle	Cylindre	Année début	Année fin	Réf.
X9 EVOLUTION	200	2002	2002	493906
X9 EVOLUTION	200	2003	2003	493906
X9	200	2002	2002	493906
X9	200	2003	2003	493906
BEVERLY CRUISER	250	2007	2009	493906
BEVERLY IE EU3	250	2006	2007	493906
BEVERLY IE EU3	250	2008	2008	493906
BEVERLY MIC EU3	250	2007	2007	493906
BEVERLY RST	250	2004	2005	493906
BEVERLY SPORT	250	2006	2008	493906
BEVERLY TOURER EU3	250	2007	2009	493906
CARNABY	250	2008	2009	493906
X EVO	250	2007	2007	493906
X EVO	250	2008	2013	493906
X7/EU3	250	2008	2008	493906
X8/EU3	250	2005	2005	493906
X8/EU3	250	2006	2008	493906
X9 EVOLUTION	250	2004	2004	493906
X9	250	2000	2001	493906
BEVERLY IE ABS E4 (EMEA)	300	2016	2019	493906
BEVERLY RST 4T 4V IE EURO3	300	2010	2010	493906
BEVERLY RST 4T 4V IE EURO3	300	2011	2015	493906
BEVERLY TOURER IE	300	2009	2010	493906
CARNABY CRUISER	300	2009	2009	493906
CARNABY CRUISER	300	2010	2010	493906
X7 EVO IE EURO3	300	2009	2010	493906
BEVERLY 4T IE	350	2011	2011	493906
BEVERLY 4T IE	350	2012	2012	493906
BEVERLY 4T IE	350	2013	2014	493906
BEVERLY 4T IE	350	2015	2015	493906
BEVERLY 4T IE	350	2016	2018	493906
BEVERLY 4T IE	350	2019	2020	493906
BEVERLY EURO3	400	2006	2007	512187
BEVERLY TOURER EURO3	400	2008	2010	512187
X EVO	400	2007	2007	493906
X EVO	400	2008	2009	493906
X EVO	400	2010	2010	493906
X EVO	400	2011	2011	493906
X8 EU3	400	2006	2006	493906
X8 EU3	400	2007	2008	493906
BEVERLY CRUISER	500	2007	2007	512187
BEVERLY CRUISER	500	2008	2008	512187
BEVERLY CRUISER	500	2009	2012	512187

Modèle	Cylindre	Année début	Année fin	Réf.
BEVERLY EURO3	500	2004	2005	512187
BEVERLY EURO3	500	2006	2006	512187
BEVERLY	500	2004	2004	512187
BEVERLY	500	2005	2006	512187
X9 EVOLUTION / ABS	500	2003	2003	486025
X9 EVOLUTION / ABS	500	2004	2004	486025
X9 EVOLUTION / ABS	500	2005	2005	486025
X9 EVOLUTION / ABS	500	2006	2007	486025
X9	500	2001	2002	493906
SUZUKI				
AN BURGM	125	2002	2002	480599
AN BURGM	125	2003	2006	480599
AN	125	1995	1995	480600
AN	125	1996	2000	480600
EPICURO 4T LC	125	1999	1999	480600
EPICURO 4T LC	125	2000	2000	480600
EPICURO 4T LC	125	2001	2001	480600
UE CT	125	2001	2001	480600
UH BURGMAN	125	2002	2006	480599
UH BURGMAN	125	2007	2013	486027
UH BURGMAN	125	2014	2014	486027
AN	150	1996	1997	480600
AN	150	1998	1998	480600
AN	150	1999	2000	480600
AN	150	2001	2001	480600
EPICURO 4T LC	150	1999	1999	480600
EPICURO 4T LC	150	2000	2000	480600
EPICURO 4T LC	150	2001	2001	480600
UE CT	150	2001	2001	480600
UH BURGMAN	150	2002	2003	480599
UH BURGMAN	150	2004	2005	480599
UH BURGMAN	150	2006	2006	480599
UH BURGMAN	200	2007	2010	486027
UH BURGMAN	200	2011	2013	486027
UH BURGMAN	200	2014	2014	486027
AN BURGMAN	250	1998	1999	480624
AN BURGMAN	250	2000	2002	480624
AN BURGMAN	250	2003	2003	480624
AN BURGMAN	250	2004	2005	480624
AN BURGMAN	250	2006	2006	480624
AN BURGMAN	400	1999	2000	480624
AN BURGMAN	400	2001	2002	480624
AN BURGMAN	400	2003	2004	480624
AN BURGMAN	400	2005	2005	480624
AN BURGMAN	400	2006	2006	480624
AN BURGMAN	400	2007	2007	512187

Modèle	Cylindre	Année début	Année fin	Réf.
AN BURGMAN	400	2008	2010	512187
AN BURGMAN	400	2011	2011	512187
AN BURGMAN	400	2012	2013	512187
AN BURGMAN	400	2014	2015	512187
AN BURGMAN	400	2016	2016	512187
AN BURGMAN	400	2018	2018	512187
AN BURGMAN	650	2003	2010	512187
AN BURGMAN	650	2011	2012	512187
AN BURGMAN	650	2013	2015	512187
AN BURGMAN	650	2016	2016	512187
AN BURGMAN	650	2018	2018	512187
SYM				
SYMPHONY S / SR / ST	125	2009	2010	493904
SYMPHONY S / SR / ST	125	2011	2014	493904
SYMPHONY S / SR / ST	125	2015	2015	493904
X PRO	125	2013	2013	512006
SYMPHONY S / ST	150	2009	2009	493904
SYMPHONY S / ST	150	2010	2010	493904
SYMPHONY S / ST	150	2011	2014	493904
SYMPHONY S / ST	150	2015	2015	493904
SYMPHONY SR	150	2012	2012	493904
JET 14	200	2018	2020	493904
SYMPHONY ST	200	2015	2015	493904
YAMAHA				
HW XENTER	125	2012	2012	480601
HW XENTER	125	2013	2016	480601
HW XENTER	125	2017	2017	480601
NXC CYGNUS X	125	2004	2006	512005
NXC CYGNUS X	125	2007	2010	480602
NXC CYGNUS X	125	2011	2011	480602
XC CYGNUS 4T	125	1997	1997	480600
XC CYGNUS 4T	125	1998	1998	480600
XC CYGNUS 4T	125	1999	1999	480600
XC CYGNUS 4T	125	2000	2000	480600
XC CYGNUS 4T	125	2001	2003	480600
X-CITY VP	125	2008	2008	480622
X-CITY VP	125	2009	2010	480622
XN TEO'S 4T LC	125	2000	2000	512005
XN TEO'S 4T LC	125	2001	2001	512005
XQ MAXTER 4T LC	125	2001	2001	480609
XQ MAXTER 4T LC	125	2002	2002	480609
YP E MAJESTY 4T	125	2003	2004	480609
YP E MAJESTY 4T	125	2005	2005	480609
YP E MAJESTY 4T	125	2006	2006	480609
YP X-MAX R / ABS	125	2006	2007	480603

**JOINT SPI MAXI SCOOTER /
MAXI SCOOTER FORK OIL SEAL**

MOTEUR

CYCLE

PNEUMATIQUE

ATELIER

ACCESSOIRES

ÉLECTRICITÉ

FILTRATION

FREINAGE

TRANSMISSION

ATHENA				
Modèle	Cylindre	Année début	Année fin	Réf.
YP X-MAX R / ABS	125	2008	2009	480603
YP X-MAX R / ABS	125	2010	2010	480625
YP X-MAX R / ABS	125	2011	2011	480625
YP X-MAX R / ABS	125	2012	2012	480625
YP X-MAX R / ABS	125	2013	2013	480625
YP X-MAX R / ABS	125	2014	2014	480625
YP X-MAX R / ABS	125	2015	2016	480625
YP X-MAX R / ABS	125	2017	2017	480625
YP-MAJESTY 4T	125	1998	2000	480601
YP-MAJESTY 4T	125	2001	2001	480601
YP-MAJESTY 4T	125	2002	2002	480609
YP-MAJESTY 4T	125	2003	2006	480609
YP-MAJESTY 4T	125	2007	2007	480609
YW BW'S	125	2010	2010	480602
ZUMA	125	2009	2009	480602
ZUMA	125	2010	2013	480602
HW XENTER	150	2012	2012	480601
HW XENTER	150	2013	2016	480601
XC FLY ONE R	150	1990	1991	480600
XC FLY ONE R	150	1992	1995	480600
XC FLY ONE R	150	1997	1998	480600
XC FLY ONE R	150	1999	1999	480600
XN TEO'S 4T LC	150	2001	2001	512005
XN TEO'S 4T LC	150	2002	2002	512005
YP MAJESTY 4T LC	150	2000	2000	480601
YP MAJESTY 4T LC	150	2001	2001	480601
YP MAJESTY 4T LC	150	2002	2002	480609
YP E MAJESTY	180	2003	2003	480609
YP E MAJESTY	180	2004	2004	480609
YP E MAJESTY	180	2005	2005	480609
YP E MAJESTY	180	2006	2006	480609
YP E MAJESTY	180	2007	2009	480609
BW N / S / ES / ET / EU	200	1985	1988	480601
X-CITY VP	250	2007	2010	480622
X-CITY VP	250	2011	2011	480622
X-CITY VP	250	2012	2012	480622
X-MAX YP R / BLACK	250	2005	2009	480603
X-MAX SPORT / ABS	250	2011	2013	480625
X-MAX SPORT / ABS	250	2014	2016	480625
X-MAX SPORT / ABS	250	2017	2018	480625
X-MAX YP R / BLACK	250	2010	2010	480625
X-MAX YP R / BLACK	250	2011	2012	480625
X-MAX YP R / BLACK	250	2013	2013	480625
X-MAX YP R / BLACK	250	2014	2014	480625
X-MAX YP R / BLACK	250	2015	2015	480625
X-MAX YP R / BLACK	250	2016	2016	480625

ATHENA				
Modèle	Cylindre	Année début	Année fin	Réf.
YP MAJESTY 4T LC / DX / ABS	250	1996	1996	512005
YP MAJESTY 4T LC / DX / ABS	250	1997	1997	512005
YP MAJESTY 4T LC / DX / ABS	250	1998	1998	512005
YP MAJESTY 4T LC / DX / ABS	250	1996	1996	493908
YP MAJESTY 4T LC / DX / ABS	250	1997	1997	493908
YP MAJESTY 4T LC / DX / ABS	250	1998	1998	493908
YP MAJESTY 4T LC / DX / ABS	250	1999	1999	493908
YP MAJESTY 4T LC / DX / ABS	250	2000	2000	493908
YP MAJESTY 4T LC / DX / ABS	250	2001	2003	493908
VERSITY XC	300	2003	2004	512175
VERSITY XC	300	2005	2005	512175
VERSITY XC	300	2006	2006	512175
VERSITY XC	300	2007	2009	512175
BW	350	1988	1988	480601
YP MAJESTY / ABS	400	2004	2004	512187
YP MAJESTY / ABS	400	2005	2006	512187
YP MAJESTY / ABS	400	2007	2008	512187
YP MAJESTY / ABS	400	2009	2010	512187
YP MAJESTY / ABS	400	2011	2011	512187
YP MAJESTY / ABS	400	2012	2013	512187
YP X-MAX R / RA	400	2013	2016	480625
YP X-MAX R / RA	400	2017	2017	480625
XP T-MAX / ABS	500	2001	2003	512017
XP T-MAX / ABS	500	2008	2009	486028
XP T-MAX / ABS	500	2010	2011	486028
XP T-MAX / ABS	500	2004	2007	480620
XP T-MAX	530	2012	2012	486028
XP T-MAX	530	2013	2013	486028
XP T-MAX	530	2014	2014	486028
XP T-MAX	530	2015	2015	512187
XP T-MAX	530	2016	2016	512187
XP T-MAX	530	2017	2018	512187
XP T-MAX	530	2019	2019	512187
YT	175	1982	1983	493904
YTM	200	1983	1985	493904
YTM DR TRI MOTO	225	1983	1985	493904

/ JOINT OFF-ROAD

ATHENA				
Modèle	Cylindre	Année début	Année fin	Réf.
APRILIA				
MX	125	1985	1985	512036
TX	125	1985	1985	493905
TX	125	1986	1986	493905
CLIMBER	280	1994	1994	493905
TX M	300	1985	1986	493905
MXV	450	2008	2010	512194
RXV	450	2006	2010	512194
RXV	450	2011	2011	512194
SXV	450	2006	2010	512194
SXV	450	2011	2011	512194
RXV	550	2006	2010	512194
RXV	550	2011	2011	512194
SXV	550	2006	2010	512194
SXV	550	2011	2011	512194
BETA				
RR	400	2005	2009	512128
RR	450	2005	2008	512172
RR	450	2009	2009	512172
RR	450	2005	2008	512173
RR	450	2009	2009	512173
RR	525	2005	2008	512144
RR	525	2009	2009	512144
RR	525	2005	2008	512146
RR	525	2009	2009	512146
BMW				
G X	450	2007	2008	512047
G X	450	2009	2010	512047
G X	450	2007	2008	512194
G X	450	2009	2010	512194
CCM				
MX	450	2008	2008	512148
MX	450	2008	2008	512171
FANTIC				
125 TRIAL	200	1978	1978	512033
125 TRIAL	200	1978	1978	512034
125 TRIAL	240	1983	1983	512033
125 TRIAL	240	1983	1983	512034
GAS GAS				
EC RACING	125	2013	2013	512047
EC RACING	125	2014	2014	512047
EC RACING	125	2015	2015	512047
EC	125	2001	2001	512047

ATHENA				
Modèle	Cylindre	Année début	Année fin	Réf.
EC	125	2002	2002	512047
EC	125	2003	2003	512047
EC	125	2004	2004	512047
EC	125	2005	2006	512047
EC	125	2007	2007	512047
EC	125	2010	2010	512047
EC	125	2011	2011	512047
EC RACING	125	2013	2013	512194
EC RACING	125	2014	2014	512194
EC RACING	125	2015	2015	512194
EC	125	2001	2001	512194
EC	125	2002	2002	512194
EC	125	2003	2003	512194
EC	125	2004	2004	512194
EC	125	2005	2006	512194
EC	125	2007	2007	512194
EC	125	2010	2010	512194
EC	125	2011	2011	512194
MC	125	2001	2001	512047
MC	125	2002	2002	512047
MC	125	2003	2003	512047
MC	125	2004	2005	512047
MC	125	2006	2007	512047
MC	125	2011	2011	512047
MC	125	2001	2001	512194
MC	125	2002	2002	512194
MC	125	2003	2003	512194
MC	125	2004	2005	512194
MC	125	2006	2007	512194
MC	125	2011	2011	512194
EC 2T	200	2014	2014	512047
EC 2T	200	2014	2014	512194
EC 2T	250	2013	2014	512047
EC F	250	2013	2013	512047
EC F	250	2014	2014	512047
EC F	250	2015	2015	512047
EC 2T	250	2013	2014	512194
EC F	250	2013	2013	512194
EC F	250	2014	2014	512194
EC F	250	2015	2015	512194
EC 2T	300	2013	2014	512047
EC 4T	300	2013	2013	512047
EC 4T	300	2014	2014	512047
EC 4T	300	2015	2015	512047
EC 2T	300	2013	2014	512194

ATHENA				
Modèle	Cylindre	Année début	Année fin	Réf.
EC 2T	300	2015	2015	512194
EC 2T	300	2016	2016	512194
EC 2T	300	2017	2017	512194
EC 2T	300	2018	2018	512194
EC 4T	300	2013	2013	512194
EC 4T	300	2014	2014	512194
EC 4T	300	2015	2015	512194
TXT PRO RAGA	300	2002	2003	486025
TXT PRO RAGA	300	2004	2005	486025
TXT	300	2002	2003	486025
TXT	300	2004	2005	486025
EC 4T	450	2013	2014	512047
EC 4T	450	2015	2015	512047
EC 4T	450	2013	2014	512194
EC 4T	450	2015	2015	512194
HONDA				
CR R	125	1974	1975	512001
CR R	125	1976	1976	512001
CR R	125	1976	1976	493902
CR R	125	1977	1977	493902
CR R	125	1978	1978	493902
CR R	125	1979	1979	512013
CR R	125	1980	1980	512013
CR R	125	1992	1992	512027
CR R	125	1993	1993	512027
CR R	125	1984	1984	512028
CR R	125	1985	1985	512028
CR R	125	1986	1986	512028
CR R	125	1987	1987	512028
CR R	125	1988	1988	512028
CR R	125	1989	1989	512028
CR R	125	1994	1994	512029
CR R	125	1995	1996	512029
CR R	125	1990	1991	512031
CR R	125	2005	2005	512048
CR R	125	2006	2006	512048
CR R	125	2007	2007	512048
CR R	125	1990	1991	512050
CR R	125	1994	1994	486028
CR R	125	1995	1996	486028
CR R	125	1992	1992	512052
CR R	125	1993	1993	512052
CR R	125	1984	1984	512120
CR R	125	1985	1985	512120
CR R	125	1986	1986	512120

ATHENA				
Modèle	Cylindre	Année début	Année fin	Réf.
CR R	125	1987	1987	512120
CR R	125	1988	1988	512120
CR R	125	1989	1989	512120
CR R	125	1990	1991	512121
CR R	125	1992	1992	512122
CR R	125	1993	1993	512122
CR R	125	1994	1994	512125
CR R	125	1995	1996	512125
CR R	125	1997	1997	512126
CR R	125	1998	1998	512126
CR R	125	1999	1999	512126
CR R	125	2000	2000	512126
CR R	125	2001	2001	512126
CRF F	125	2014	2015	486026
CRF F	125	2016	2018	486026
CRF F	150	2003	2003	493902
CRF F	150	2004	2005	493902
CRF F	150	2006	2006	493902
CRF F	150	2007	2007	493902
CRF F	150	2008	2008	493902
CRF F	150	2009	2009	493902
CRF F	150	2010	2011	493902
CRF F	150	2012	2015	493902
CRF F	150	2016	2016	493902
CRF F	150	2017	2017	493902
CRF R	150	2007	2009	500737
CRF R	150	2010	2010	500737
CRF R	150	2011	2011	500737
CRF R	150	2012	2015	500737
CRF R	150	2016	2017	500737
CRF R	150	2018	2018	500737
CRF R	150	2019	2019	500737
CRF R	150	2020	2020	500737
CRF R	150	2007	2009	512193
CRF R	150	2010	2010	512193
CRF R	150	2011	2011	512193
CRF R	150	2012	2015	512193
CRF R	150	2016	2017	512193
CRF R	150	2018	2018	512193
CRF R	150	2019	2019	512193
CRF R	150	2020	2020	512193
XR R	200	1981	1982	493902
XR R	200	1983	1983	493902
XR R	200	1984	1985	480603
XR R	200	1986	1991	480603

ATHENA				
Modèle	Cylindre	Année début	Année fin	Réf.
XR R	200	1992	1993	480603
XR R	200	1994	1996	480603
XR R	200	1997	1998	480603
XR R	200	1999	1999	480603
CRF F	230	2003	2003	512015
CRF F	230	2004	2006	512015
CRF F	230	2007	2007	512015
CRF F	230	2008	2009	512015
CRF F	230	2010	2011	512015
CRF F	230	2012	2013	512015
CRF F	230	2014	2015	512015
CRF F	230	2016	2016	512015
CRF F	230	2017	2017	512015
CRF F	230	2019	2019	512015
CR R	250	1973	1975	493902
CR R	250	1976	1976	493902
CR R	250	1978	1980	512012
CR R	250	1981	1981	512025
CR R	250	1992	1994	512027
CR R	250	1983	1983	512028
CR R	250	1984	1984	512028
CR R	250	1985	1985	512028
CR R	250	1986	1986	512028
CR R	250	1987	1987	512028
CR R	250	1988	1988	512028
CR R	250	1995	1995	512029
CR R	250	1982	1982	512030
CR R	250	1989	1989	512031
CR R	250	1990	1990	512031
CR R	250	1991	1991	512031
CR R	250	1997	1998	512042
CR R	250	1999	1999	512042
CR R	250	2000	2000	512042
CR R	250	2001	2001	512042
CR R	250	2002	2002	512042
CR R	250	2003	2003	512042
CR R	250	2004	2004	512042
CR R	250	2005	2005	512042
CR R	250	2006	2006	512042
CR R	250	2007	2007	512042
CR R	250	1996	1996	512048
CR R	250	1989	1989	512050
CR R	250	1990	1990	512050
CR R	250	1991	1991	512050
CR R	250	1995	1995	486028

ATHENA				
Modèle	Cylindre	Année début	Année fin	Réf.
CR R	250	1992	1994	512052
CR R	250	1983	1983	512120
CR R	250	1984	1984	512120
CR R	250	1985	1985	512120
CR R	250	1986	1986	512120
CR R	250	1987	1987	512120
CR R	250	1988	1988	512120
CR R	250	1990	1990	512121
CR R	250	1991	1991	512121
CR R	250	1992	1994	512122
CR R	250	1997	1998	512123
CR R	250	1999	1999	512123
CR R	250	2000	2000	512123
CR R	250	2001	2001	512123
CR R	250	2002	2002	512123
CR R	250	2003	2003	512123
CR R	250	2004	2004	512123
CR R	250	2005	2005	512123
CR R	250	2006	2006	512123
CR R	250	2007	2007	512123
CR R	250	1995	1995	512125
CR R	250	1996	1996	512126
CRE F R	250	2005	2007	512123
CRE F X	250	2004	2004	512123
CRE F X	250	2005	2006	512123
CRE F X	250	2007	2008	512123
CRE F X	250	2009	2009	512123
CRE F X	250	2010	2010	512123
CRE F R	250	2005	2007	512140
CRE F X	250	2004	2004	512140
CRE F X	250	2005	2006	512140
CRE F X	250	2007	2008	512140
CRE F X	250	2009	2009	512140
CRE F X	250	2010	2010	512140
CRF R	250	2015	2015	512041
CRF R	250	2016	2016	512041
CRF R	250	2017	2017	512041
CRF R	250	2018	2018	512041
CRF R	250	2019	2019	512041
CRF R	250	2020	2020	512041
CRF RX	250	2019	2019	512041
CRF RX	250	2020	2020	512041
CRF R	250	2004	2004	512123
CRF R	250	2005	2005	512123
CRF R	250	2006	2006	512123

ATHENA				
Modèle	Cylindre	Année début	Année fin	Réf.
CRF R	250	2007	2007	512123
CRF R	250	2008	2008	512123
CRF R	250	2009	2009	512123
CRF X	250	2004	2005	512123
CRF X	250	2006	2006	512123
CRF X	250	2007	2009	512123
CRF X	250	2010	2011	512123
CRF X	250	2012	2013	512123
CRF X	250	2014	2014	512123
CRF X	250	2015	2015	512123
CRF X	250	2016	2016	512123
CRF X	250	2017	2017	512123
CRF R	250	2004	2004	512140
CRF R	250	2005	2005	512140
CRF R	250	2006	2006	512140
CRF R	250	2007	2007	512140
CRF R	250	2008	2008	512140
CRF R	250	2009	2009	512140
CRF X	250	2004	2005	512140
CRF X	250	2006	2006	512140
CRF X	250	2007	2009	512140
CRF X	250	2010	2011	512140
CRF X	250	2012	2013	512140
CRF X	250	2014	2014	512140
CRF X	250	2015	2015	512140
CRF X	250	2016	2016	512140
CRF X	250	2017	2017	512140
CRF R	250	2010	2010	512141
CRF R	250	2011	2011	512141
CRF R	250	2012	2012	512141
CRF R	250	2013	2013	512141
CRF R	250	2014	2014	512141
CRF R	250	2010	2010	512144
CRF R	250	2011	2011	512144
CRF R	250	2012	2012	512144
CRF R	250	2013	2013	512144
CRF R	250	2014	2014	512144
CRM F R	250	2005	2007	512123
CRM X IE	250	2007	2007	512123
CRM F R	250	2005	2007	512140
CRM X IE	250	2007	2007	512140
CRE F X	290	2007	2007	512123
CRE F X	290	2007	2007	512140
CRM X IE	290	2007	2007	512123
CRM X IE	290	2007	2007	512140

ATHENA				
Modèle	Cylindre	Année début	Année fin	Réf.
CRE F X	300	2004	2009	512123
CRE F X	300	2010	2010	512123
CRE F X	300	2004	2009	512140
CRE F X	300	2010	2010	512140
XR R	400	1996	1996	512028
XR R	400	1997	1999	512028
XR R	400	1996	1996	512120
XR R	400	1997	1999	512120
CR RB / R ELSINORE	450	1981	1981	512025
CRE F R	450	2005	2006	512123
CRE F R	450	2007	2007	512123
CRE F R	450	2008	2008	512123
CRE MOTARD	450	2002	2003	512123
CRE MOTARD	450	2004	2010	512123
CRE X IE	450	2007	2008	512123
CRE F R	450	2005	2006	512140
CRE F R	450	2007	2007	512140
CRE F R	450	2008	2008	512140
CRE MOTARD	450	2002	2003	512140
CRE MOTARD	450	2004	2010	512140
CRE X IE	450	2007	2008	512140
CRE F R	450	2009	2010	512149
CRE F R	450	2009	2010	512171
CRF R	450	2017	2017	512041
CRF R	450	2018	2018	512041
CRF R	450	2019	2019	512041
CRF R	450	2020	2020	512041
CRF RX	450	2017	2017	512041
CRF RX	450	2018	2018	512041
CRF RX	450	2019	2019	512041
CRF RX	450	2020	2020	512041
CRF X	450	2019	2019	512041
CRF R	450	2002	2002	512123
CRF R	450	2003	2003	512123
CRF R	450	2004	2004	512123
CRF R	450	2005	2005	512123
CRF R	450	2006	2006	512123
CRF R	450	2007	2007	512123
CRF R	450	2008	2008	512123
CRF X	450	2005	2005	512123
CRF X	450	2006	2007	512123
CRF X	450	2008	2008	512123
CRF X	450	2009	2009	512123
CRF X	450	2010	2010	512123
CRF X	450	2011	2011	512123

ATHENA				
Modèle	Cylindre	Année début	Année fin	Réf.
CRF X	450	2012	2013	512123
CRF X	450	2014	2014	512123
CRF X	450	2015	2015	512123
CRF X	450	2017	2017	512123
CRF R	450	2002	2002	512140
CRF R	450	2003	2003	512140
CRF R	450	2004	2004	512140
CRF R	450	2005	2005	512140
CRF R	450	2006	2006	512140
CRF R	450	2007	2007	512140
CRF R	450	2008	2008	512140
CRF X	450	2005	2005	512140
CRF X	450	2006	2007	512140
CRF X	450	2008	2008	512140
CRF X	450	2009	2009	512140
CRF X	450	2010	2010	512140
CRF X	450	2011	2011	512140
CRF X	450	2012	2013	512140
CRF X	450	2014	2014	512140
CRF X	450	2015	2015	512140
CRF X	450	2017	2017	512140
CRF R	450	2015	2015	512146
CRF R	450	2016	2016	512146
CRF R	450	2009	2009	512149
CRF R	450	2011	2011	512149
CRF R	450	2012	2012	512149
CRF R	450	2013	2013	512149
CRF R	450	2014	2014	512149
CRF R	450	2015	2015	512149
CRF R	450	2016	2016	512149
CRF R	450	2009	2009	512171
CRF R	450	2011	2011	512171
CRF R	450	2012	2012	512171
CRF R	450	2013	2013	512171
CRF R	450	2014	2014	512171
CRM X IE	450	2007	2007	512122
CRM X IE	450	2008	2008	512122
CRM F R	450	2005	2006	512123
CRM F R	450	2007	2007	512123
CRM F R	450	2008	2008	512123
CRM F R	450	2005	2006	512140
CRM F R	450	2007	2007	512140
CRM F R	450	2008	2008	512140
CRM X IE	450	2007	2007	512140
CRM X IE	450	2008	2008	512140

ATHENA				
Modèle	Cylindre	Année début	Année fin	Réf.
CRM F R	450	2009	2010	512149
CRM F R	450	2009	2010	512171
CR R	480	1983	1983	512028
CR R	480	1982	1982	512030
CR R	480	1983	1983	512120
CRM X IE	490	2007	2007	512123
CRM X IE	490	2008	2008	512123
CRM X IE	490	2007	2007	512140
CRM X IE	490	2008	2008	512140
CR R	500	1992	1994	512027
CR R	500	1984	1984	512028
CR R	500	1985	1986	512028
CR R	500	1987	1988	512028
CR R	500	1995	1995	512029
CR R	500	1989	1989	512031
CR R	500	1990	1990	512031
CR R	500	1991	1991	512031
CR R	500	1996	1999	512048
CR R	500	2000	2001	512048
CR R	500	2002	2002	512048
CR R	500	1989	1989	512050
CR R	500	1990	1990	512050
CR R	500	1991	1991	512050
CR R	500	1995	1995	486028
CR R	500	1992	1994	512052
CR R	500	1984	1984	512120
CR R	500	1985	1986	512120
CR R	500	1987	1988	512120
CR R	500	1990	1990	512121
CR R	500	1991	1991	512121
CR R	500	1992	1994	512122
CR R	500	1995	1995	512125
CR R	500	1996	1999	512126
CR R	500	2000	2001	512126
CRF X	500	2005	2009	512123
CRF X	500	2005	2009	512140
XR R	600	1985	1987	512028
XR R	600	1988	1990	512028
XR R	600	1991	1992	512028
XR R	600	1993	1993	512028
XR R	600	1994	1995	512028
XR R	600	1996	1998	512028
XR R	600	1999	1999	512028
XR R	600	1985	1987	512120
XR R	600	1988	1990	512120

ATHENA				
Modèle	Cylindre	Année début	Année fin	Réf.
XR R	600	1991	1992	512120
XR R	600	1993	1993	512120
XR R	600	1994	1995	512120
XR R	600	1996	1998	512120
XR R	600	1999	1999	512120

HUSABERG

FE	390	2010	2010	512146
FE	390	2010	2010	512172
FE	390	2011	2011	512172
FE	390	2012	2012	512172
FE	390	2013	2013	512172
FE	390	2014	2018	512172
FE	450	2009	2010	512146
FE	450	2009	2010	512172
FX	450	2010	2010	512146
FE	570	2010	2010	512007
FE	570	2010	2010	512172
FE	570	2011	2012	512172
FE	570	2013	2013	512172
FE	570	2014	2018	512172
FS	570	2010	2010	512007

HUSQVARNA

CR Husqvarna Engine	125	1981	1981	493905
CR Husqvarna Engine	125	1982	1983	512022
CR Husqvarna Engine	125	1984	1984	512022
CR Husqvarna Engine	125	1992	1992	512031
CR Husqvarna Engine	125	1993	1993	512031
CR Husqvarna Engine	125	1994	1994	512031
CR Husqvarna Engine	125	1995	1995	512040
CR Husqvarna Engine	125	1996	1996	512040
CR Husqvarna Engine	125	1997	1997	512047
CR Husqvarna Engine	125	1998	1998	512047
CR Husqvarna Engine	125	1999	1999	512047
CR Husqvarna Engine	125	2000	2000	512047
CR Husqvarna Engine	125	2001	2001	512047
CR Husqvarna Engine	125	2002	2002	512047
CR Husqvarna Engine	125	2003	2004	512047
CR Husqvarna Engine	125	2005	2005	512047
CR Husqvarna Engine	125	2006	2008	512047
CR Husqvarna Engine	125	1992	1992	512050
CR Husqvarna Engine	125	1993	1993	512050
CR Husqvarna Engine	125	1994	1994	512050
CR Husqvarna Engine	125	2009	2009	512129
CR Husqvarna Engine	125	2010	2013	512129
CR Husqvarna Engine	125	2014	2014	512129

ATHENA				
Modèle	Cylindre	Année début	Année fin	Réf.
CR Husqvarna Engine	125	2009	2009	512149
CR Husqvarna Engine	125	2010	2013	512149
SM S Husqvarna Engine	125	2000	2002	480623
SM S Husqvarna Engine	125	2003	2009	480623
SM S Husqvarna Engine	125	2010	2010	480623
SM S Husqvarna Engine	125	2011	2011	480623
SM S Husqvarna Engine	125	2012	2012	480623
SM S Husqvarna Engine	125	1998	1998	512047
SM S Husqvarna Engine	125	1999	1999	512047
SM S Husqvarna Engine	125	1998	1998	512049
SM S Husqvarna Engine	125	1998	1998	512194
SM S Husqvarna Engine	125	1999	1999	512194
SMR 4T	125	2010	2010	512025
SMR 4T	125	2011	2013	512025
SMS4 4T	125	2010	2011	512025
TC Ktm engine	125	2014	2014	512172
TC Ktm engine	125	2015	2015	512172
TC Ktm engine	125	2016	2016	512172
TC Ktm engine	125	2017	2017	512172
TC Ktm engine	125	2018	2018	512172
TC Ktm engine	125	2019	2019	512172
TC Ktm engine	125	2020	2020	512172
TC Ktm engine	125	2014	2014	512173
TC Ktm engine	125	2015	2015	512173
TC Ktm engine	125	2016	2016	512173
TC Ktm engine	125	2017	2017	512173
TC Ktm engine	125	2018	2018	512173
TC Ktm engine	125	2019	2019	512173
TC Ktm engine	125	2020	2020	512173
TE 4T	125	2010	2010	512025
TE 4T	125	2011	2013	512025
TE Ktm engine	125	2014	2015	512172
TE Ktm engine	125	2016	2016	512172
TE Ktm engine	125	2017	2017	512172
TE Ktm engine	125	2014	2015	512173
TE Ktm engine	125	2016	2016	512173
TE Ktm engine	125	2017	2017	512173
TX Ktm engine	125	2017	2017	512172
TX Ktm engine	125	2018	2018	512172
TX Ktm engine	125	2019	2019	512172
TX Ktm engine	125	2017	2017	512173
TX Ktm engine	125	2018	2018	512173
TX Ktm engine	125	2019	2019	512173
WR Husqvarna Engine	125	1982	1983	512022
WR Husqvarna Engine	125	1984	1984	512022

JOINT SPI OFF-ROAD / OFF ROAD FORK OIL SEAL

MOTEUR

CYCLE

PNEUMATIQUE

ATELIER

ACCESSOIRES

ÉLECTRICITÉ

FILTRATION

FREINAGE

TRANSMISSION

ATHENA				
Modèle	Cylindre	Année début	Année fin	Réf.
WR Husqvarna Engine	125	1992	1993	512031
WR Husqvarna Engine	125	1994	1994	512031
WR Husqvarna Engine	125	1995	1995	512040
WR Husqvarna Engine	125	1996	1996	512040
WR Husqvarna Engine	125	1997	1997	512047
WR Husqvarna Engine	125	1998	1998	512047
WR Husqvarna Engine	125	1999	1999	512047
WR Husqvarna Engine	125	2000	2000	512047
WR Husqvarna Engine	125	2001	2001	512047
WR Husqvarna Engine	125	2002	2002	512047
WR Husqvarna Engine	125	2003	2004	512047
WR Husqvarna Engine	125	2005	2007	512047
WR Husqvarna Engine	125	2008	2008	512047
WR Husqvarna Engine	125	1992	1993	512050
WR Husqvarna Engine	125	1994	1994	512050
WR Husqvarna Engine	125	2009	2009	512129
WR Husqvarna Engine	125	2010	2010	512129
WR Husqvarna Engine	125	2011	2012	512129
WR Husqvarna Engine	125	2013	2013	512129
WR Husqvarna Engine	125	2014	2014	512129
WR Husqvarna Engine	125	2009	2009	512149
WR Husqvarna Engine	125	2010	2010	512149
WR Husqvarna Engine	125	2011	2012	512149
WRK	125	1992	1994	512031
WRK	125	1987	1987	512036
WRK	125	1988	1988	512036
WRK	125	1992	1994	512050
TE Ktm engine	150	2017	2017	512172
TE Ktm engine	150	2018	2018	512172
TE Ktm engine	150	2019	2019	512172
TE Ktm engine	150	2020	2020	512172
TE Ktm engine	150	2017	2017	512173
TE Ktm engine	150	2018	2018	512173
TE Ktm engine	150	2019	2019	512173
TE Ktm engine	150	2020	2020	512173
CR	250	1982	1983	512022
CR	250	1984	1984	512022
CR	250	1992	1992	512031
CR	250	1993	1993	512031
CR	250	1994	1994	512031
CR	250	1995	1995	512040
CR	250	1996	1996	512040
CR	250	1997	1997	512042
CR	250	1998	1998	512042
CR	250	1999	1999	512047

ATHENA				
Modèle	Cylindre	Année début	Année fin	Réf.
CR	250	2000	2000	512047
CR	250	2001	2001	512047
CR	250	2002	2002	512047
CR	250	2003	2004	512047
CR	250	1992	1992	512050
CR	250	1993	1993	512050
CR	250	1994	1994	512050
CR	250	1999	1999	512194
CR	250	2000	2000	512194
CR	250	2001	2001	512194
CR	250	2002	2002	512194
CR	250	2003	2004	512194
CR	250	2003	2004	512194
FC Ktm engine	250	2014	2014	512172
FC Ktm engine	250	2015	2015	512172
FC Ktm engine	250	2016	2016	512172
FC Ktm engine	250	2017	2017	512172
FC Ktm engine	250	2018	2018	512172
FC Ktm engine	250	2019	2019	512172
FC Ktm engine	250	2020	2020	512172
FC Ktm engine	250	2014	2014	512173
FC Ktm engine	250	2015	2015	512173
FC Ktm engine	250	2016	2016	512173
FC Ktm engine	250	2017	2017	512173
FC Ktm engine	250	2018	2018	512173
FC Ktm engine	250	2019	2019	512173
FC Ktm engine	250	2020	2020	512173
FE Ktm engine	250	2016	2016	512172
FE Ktm engine	250	2017	2018	512172
FE Ktm engine	250	2019	2019	512172
FE Ktm engine	250	2020	2020	512172
FE Ktm engine	250	2016	2016	512173
FE Ktm engine	250	2017	2018	512173
FE Ktm engine	250	2019	2019	512173
FE Ktm engine	250	2020	2020	512173
SMR	250	2003	2004	512047
SMR	250	2005	2005	512047
SMR	250	2006	2006	512047
SMR	250	2007	2007	512047
SMR	250	2008	2008	512047
SMR	250	2009	2009	512047
TC Husqvarna Engine	250	2003	2003	512047
TC Husqvarna Engine	250	2004	2004	512047
TC Husqvarna Engine	250	2005	2005	512047
TC Husqvarna Engine	250	2006	2007	512047
TC Husqvarna Engine	250	2008	2008	512047

				
Modèle	Cylindre	Année début	Année fin	Réf.
TC Husqvarna Engine	250	2009	2009	512047
TC Husqvarna Engine	250	2010	2011	512129
TC Husqvarna Engine	250	2012	2013	512129
TC Husqvarna Engine	250	2014	2014	512129
TC Husqvarna Engine	250	2010	2011	512149
TC Husqvarna Engine	250	2012	2013	512149
TC Husqvarna Engine	250	2014	2014	512149
TC Ktm engine	250	2014	2015	512172
TC Ktm engine	250	2016	2016	512172
TC Ktm engine	250	2017	2017	512172
TC Ktm engine	250	2018	2018	512172
TC Ktm engine	250	2019	2019	512172
TC Ktm engine	250	2020	2020	512172
TC Ktm engine	250	2014	2015	512173
TC Ktm engine	250	2016	2016	512173
TC Ktm engine	250	2017	2017	512173
TC Ktm engine	250	2018	2018	512173
TC Ktm engine	250	2019	2019	512173
TC Ktm engine	250	2020	2020	512173
TE Husqvarna Engine	250	2003	2003	512047
TE Husqvarna Engine	250	2004	2004	512047
TE Husqvarna Engine	250	2005	2005	512047
TE Husqvarna Engine	250	2006	2007	512047
TE Husqvarna Engine	250	2008	2009	512047
TE Husqvarna Engine	250	2010	2010	512129
TE Husqvarna Engine	250	2011	2011	512129
TE Husqvarna Engine	250	2012	2012	512129
TE Husqvarna Engine	250	2013	2013	512129
TE Husqvarna Engine	250	2014	2014	512129
TE Husqvarna Engine	250	2010	2010	512149
TE Husqvarna Engine	250	2011	2011	512149
TE Husqvarna Engine	250	2012	2012	512149
TE Husqvarna Engine	250	2013	2013	512149
TE Husqvarna Engine	250	2014	2014	512149
TE Ktm engine	250	2014	2015	512172
TE Ktm engine	250	2016	2016	512172
TE Ktm engine	250	2017	2017	512172
TE Ktm engine	250	2018	2018	512172
TE Ktm engine	250	2019	2019	512172
TE Ktm engine	250	2020	2020	512172
TE Ktm engine	250	2014	2015	512173
TE Ktm engine	250	2016	2016	512173
TE Ktm engine	250	2017	2017	512173
TE Ktm engine	250	2018	2018	512173
TE Ktm engine	250	2019	2019	512173

				
Modèle	Cylindre	Année début	Année fin	Réf.
TE Ktm engine	250	2020	2020	512173
TXC Husqvarna Engine	250	2003	2004	512047
TXC Husqvarna Engine	250	2005	2005	512047
TXC Husqvarna Engine	250	2006	2006	512047
TXC Husqvarna Engine	250	2007	2007	512047
TXC Husqvarna Engine	250	2008	2009	512047
TXC Husqvarna Engine	250	2010	2011	512129
TXC Husqvarna Engine	250	2012	2012	512129
TXC Husqvarna Engine	250	2013	2013	512129
TXC Husqvarna Engine	250	2014	2014	512129
TXC Husqvarna Engine	250	2010	2011	512149
TXC Husqvarna Engine	250	2012	2012	512149
TXC Husqvarna Engine	250	2013	2013	512149
TXC Husqvarna Engine	250	2014	2014	512149
WR Husqvarna Engine	250	1981	1981	493905
WR Husqvarna Engine	250	1982	1983	512022
WR Husqvarna Engine	250	1984	1984	512022
WR Husqvarna Engine	250	1992	1994	512031
WR Husqvarna Engine	250	1995	1995	512040
WR Husqvarna Engine	250	1996	1997	512040
WR Husqvarna Engine	250	1998	1998	512044
WR Husqvarna Engine	250	1999	1999	512047
WR Husqvarna Engine	250	2000	2000	512047
WR Husqvarna Engine	250	2001	2001	512047
WR Husqvarna Engine	250	2002	2002	512047
WR Husqvarna Engine	250	2003	2005	512047
WR Husqvarna Engine	250	2006	2007	512047
WR Husqvarna Engine	250	2008	2008	512047
WR Husqvarna Engine	250	1992	1994	512050
WR Husqvarna Engine	250	2009	2009	512129
WR Husqvarna Engine	250	2010	2011	512129
WR Husqvarna Engine	250	2012	2012	512129
WR Husqvarna Engine	250	2013	2013	512129
WR Husqvarna Engine	250	2014	2014	512129
WR Husqvarna Engine	250	2009	2009	512149
WR Husqvarna Engine	250	2010	2011	512149
WR Husqvarna Engine	250	2012	2012	512149
WR Husqvarna Engine	250	2013	2013	512149
WR Husqvarna Engine	250	2014	2014	512149
WRK	250	1992	1994	512031
WRK	250	1992	1994	512050
WR	260	1992	1993	512031
WR	260	1992	1993	512050
WRK	260	1992	1993	512031
WRK	260	1994	1994	512031

MOTEUR

CYCLE

PNEUMATIQUE

ATELIER

ACCESSOIRES

ÉLECTRICITÉ

FILTRATION

FREINAGE

TRANSMISSION

ATHENA				
Modèle	Cylindre	Année début	Année fin	Réf.
WRK	260	1992	1993	512050
WRK	260	1994	1994	512050
TE Ktm engine	300	2014	2015	512172
TE Ktm engine	300	2016	2016	512172
TE Ktm engine	300	2017	2017	512172
TE Ktm engine	300	2018	2018	512172
TE Ktm engine	300	2019	2019	512172
TE Ktm engine	300	2020	2020	512172
TE Ktm engine	300	2014	2015	512173
TE Ktm engine	300	2016	2016	512173
TE Ktm engine	300	2017	2017	512173
TE Ktm engine	300	2018	2018	512173
TE Ktm engine	300	2019	2019	512173
TE Ktm engine	300	2020	2020	512173
TX	300	2017	2017	512172
TX	300	2018	2018	512172
TX	300	2019	2019	512172
TX	300	2020	2020	512172
TX	300	2017	2017	512173
TX	300	2018	2018	512173
TX	300	2019	2019	512173
TX	300	2020	2020	512173
WR	300	2009	2012	512129
WR	300	2013	2013	512129
WR	300	2014	2014	512129
WR	300	2009	2012	512149
WR	300	2013	2013	512149
WR	300	2014	2014	512149
SMR	310	2010	2010	512129
SMR	310	2011	2012	512129
SMR	310	2010	2010	512149
SMR	310	2011	2012	512149
TC	310	2010	2010	512129
TC	310	2011	2011	512129
TC	310	2012	2012	512129
TC	310	2010	2010	512149
TC	310	2011	2011	512149
TC	310	2012	2012	512149
TE Husqvarna Engine	310	2011	2011	512129
TE Husqvarna Engine	310	2012	2012	512129
TE Husqvarna Engine	310	2013	2013	512129
TE Husqvarna Engine	310	2014	2014	512129
TE Husqvarna Engine	310	2011	2011	512149
TE Husqvarna Engine	310	2012	2012	512149
TE Husqvarna Engine	310	2013	2013	512149

ATHENA				
Modèle	Cylindre	Année début	Année fin	Réf.
TE Husqvarna Engine	310	2014	2014	512149
TXC Husqvarna Engine	310	2010	2010	512129
TXC Husqvarna Engine	310	2011	2011	512129
TXC Husqvarna Engine	310	2012	2012	512129
TXC Husqvarna Engine	310	2013	2013	512129
TXC Husqvarna Engine	310	2014	2014	512129
TXC Husqvarna Engine	310	2010	2010	512149
TXC Husqvarna Engine	310	2011	2011	512149
TXC Husqvarna Engine	310	2012	2012	512149
TXC Husqvarna Engine	310	2013	2013	512149
TXC Husqvarna Engine	310	2014	2014	512149
FC Ktm engine	350	2014	2014	512172
FC Ktm engine	350	2015	2015	512172
FC Ktm engine	350	2016	2016	512172
FC Ktm engine	350	2017	2017	512172
FC Ktm engine	350	2018	2018	512172
FC Ktm engine	350	2019	2019	512172
FC Ktm engine	350	2020	2020	512172
FC Ktm engine	350	2014	2014	512173
FC Ktm engine	350	2015	2015	512173
FC Ktm engine	350	2016	2016	512173
FC Ktm engine	350	2017	2017	512173
FC Ktm engine	350	2018	2018	512173
FC Ktm engine	350	2019	2019	512173
FC Ktm engine	350	2020	2020	512173
FE Ktm engine	350	2014	2015	512172
FE Ktm engine	350	2016	2016	512172
FE Ktm engine	350	2017	2018	512172
FE Ktm engine	350	2019	2019	512172
FE Ktm engine	350	2020	2020	512172
FE Ktm engine	350	2014	2015	512173
FE Ktm engine	350	2016	2016	512173
FE Ktm engine	350	2017	2018	512173
FE Ktm engine	350	2019	2019	512173
FE Ktm engine	350	2020	2020	512173
FX	350	2017	2018	512172
FX	350	2019	2019	512172
FX	350	2020	2020	512172
FX	350	2017	2018	512173
FX	350	2019	2019	512173
FX	350	2020	2020	512173
TC	350	1992	1994	512031
TC	350	1992	1994	512050
TE	350	1992	1994	512031
TE	350	1995	1995	512040

ATHENA				
Modèle	Cylindre	Année début	Année fin	Réf.
TE	350	1996	1996	512040
TE	350	1992	1994	512050
CR	360	1992	1992	512031
CR	360	1993	1993	512031
CR	360	1994	1994	512031
CR	360	2000	2000	512047
CR	360	2001	2001	512047
CR	360	1992	1992	512050
CR	360	1993	1993	512050
CR	360	1994	1994	512050
WR	360	1992	1992	512031
WR	360	1993	1994	512031
WR	360	1995	1995	512040
WR	360	1996	1996	512040
WR	360	1997	1997	512044
WR	360	1998	1998	512044
WR	360	1999	1999	512047
WR	360	2000	2000	512047
WR	360	2001	2001	512047
WR	360	2002	2002	512047
WR	360	1992	1992	512050
WR	360	1993	1994	512050
TE	400	2001	2001	512047
TE	400	2002	2004	512047
TE	410	1996	1996	512040
TE	410	1997	1998	512044
TE	410	1999	1999	512044
TE	410	2000	2000	512044
FC Ktm engine	450	2014	2015	512172
FC Ktm engine	450	2016	2016	512172
FC Ktm engine	450	2017	2017	512172
FC Ktm engine	450	2018	2018	512172
FC Ktm engine	450	2019	2019	512172
FC Ktm engine	450	2020	2020	512172
FC Ktm engine	450	2014	2015	512173
FC Ktm engine	450	2016	2016	512173
FC Ktm engine	450	2017	2017	512173
FC Ktm engine	450	2018	2018	512173
FC Ktm engine	450	2019	2019	512173
FC Ktm engine	450	2020	2020	512173
FE Ktm engine	450	2014	2015	512172
FE Ktm engine	450	2016	2016	512172
FE Ktm engine	450	2017	2018	512172
FE Ktm engine	450	2019	2019	512172
FE Ktm engine	450	2020	2020	512172

ATHENA				
Modèle	Cylindre	Année début	Année fin	Réf.
FE Ktm engine	450	2014	2015	512173
FE Ktm engine	450	2016	2016	512173
FE Ktm engine	450	2017	2018	512173
FE Ktm engine	450	2019	2019	512173
FE Ktm engine	450	2020	2020	512173
FS Ktm engine	450	2017	2017	512172
FS Ktm engine	450	2018	2018	512172
FS Ktm engine	450	2019	2019	512172
FS Ktm engine	450	2020	2020	512172
FS Ktm engine	450	2017	2017	512173
FS Ktm engine	450	2018	2018	512173
FS Ktm engine	450	2019	2019	512173
FS Ktm engine	450	2020	2020	512173
FX	450	2017	2017	512172
FX	450	2018	2018	512172
FX	450	2019	2019	512172
FX	450	2020	2020	512172
FX	450	2017	2017	512173
FX	450	2018	2018	512173
FX	450	2019	2019	512173
FX	450	2020	2020	512173
SMR	450	2003	2004	512047
SMR	450	2005	2005	512047
SMR	450	2006	2006	512047
SMR	450	2015	2015	512172
SMR	450	2016	2018	512172
SMR	450	2015	2015	512173
SMR	450	2016	2018	512173
TC	450	2003	2003	512047
TC	450	2004	2004	512047
TC	450	2005	2005	512047
TC	450	2006	2009	512047
TC 449 Husqvarna Engine	450	2011	2011	512129
TC 449 Husqvarna Engine	450	2012	2013	512129
TC 449 Husqvarna Engine	450	2014	2014	512129
TC	450	2010	2010	512129
TC 449 Husqvarna Engine	450	2011	2011	512149
TC 449 Husqvarna Engine	450	2012	2013	512149
TC 449 Husqvarna Engine	450	2014	2014	512149
TC	450	2010	2010	512149
TE	450	2003	2004	512047
TE	450	2005	2005	512047
TE	450	2006	2007	512047
TE	450	2008	2009	512047
TE 449 Husqvarna Engine	450	2011	2011	512129

ATHENA				
Modèle	Cylindre	Année début	Année fin	Réf.
TE 449 Husqvarna Engine	450	2012	2013	512129
TE 449 Husqvarna Engine	450	2014	2014	512129
TE	450	2010	2010	512129
TE	450	2011	2012	512129
TE	450	2013	2014	512129
TE	450	2015	2018	512129
TE 449 Husqvarna Engine	450	2011	2011	512149
TE 449 Husqvarna Engine	450	2012	2013	512149
TE 449 Husqvarna Engine	450	2014	2014	512149
TE	450	2010	2010	512149
TE	450	2011	2012	512149
TE	450	2013	2014	512149
TE	450	2015	2018	512149
TXC	450	2003	2003	512047
TXC	450	2004	2004	512047
TXC	450	2005	2005	512047
TXC	450	2006	2007	512047
TXC	450	2008	2009	512047
TXC 449	450	2011	2011	512129
TXC 449	450	2012	2012	512129
TXC	450	2010	2010	512129
TXC	450	2011	2012	512129
TXC	450	2013	2018	512129
TXC 449	450	2011	2011	512149
TXC 449	450	2012	2012	512149
TXC	450	2010	2010	512149
TXC	450	2011	2012	512149
TXC	450	2013	2018	512149
TCX 511- cc	480	2011	2012	512129
TCX 511- cc	480	2013	2013	512129
TCX 511- cc	480	2011	2012	512149
TCX 511- cc	480	2013	2013	512149
FE 501 Ktm engine	510	2014	2015	512172
FE 501 Ktm engine	510	2016	2016	512172
FE 501 Ktm engine	510	2017	2017	512172
FE 501 Ktm engine	510	2018	2018	512172
FE 501 Ktm engine	510	2019	2019	512172
FE 501 Ktm engine	510	2020	2020	512172
FE 501 Ktm engine	510	2014	2015	512173
FE 501 Ktm engine	510	2016	2016	512173
FE 501 Ktm engine	510	2017	2017	512173
FE 501 Ktm engine	510	2018	2018	512173
FE 501 Ktm engine	510	2019	2019	512173
FE 501 Ktm engine	510	2020	2020	512173
SMR 511	510	2011	2011	512044

ATHENA				
Modèle	Cylindre	Année début	Année fin	Réf.
SMR 511	510	2012	2012	512044
SMR	510	2004	2004	512047
SMR	510	2005	2005	512047
SMR	510	2006	2006	512047
SMR	510	2007	2007	512047
SMR	510	2008	2009	512047
SMR	510	2010	2010	512129
SMR	510	2011	2011	512129
SMR	510	2012	2018	512129
TC	510	2004	2004	512047
TC	510	2005	2005	512047
TC	510	2006	2009	512047
TC	510	2010	2010	512047
TC	510	2010	2010	512129
TC	510	2010	2010	512149
TE R	510	2004	2004	512047
TE R	510	2005	2005	512047
TE R	510	2006	2006	512047
TE	510	2004	2004	512047
TE	510	2005	2005	512047
TE	510	2006	2007	512047
TE	510	2008	2009	512047
TE	510	2010	2010	512047
TE 511 Husqvarna Engine	510	2011	2011	512129
TE 511 Husqvarna Engine	510	2012	2013	512129
TE 511 Husqvarna Engine	510	2014	2014	512129
TE	510	2010	2010	512129
TE	510	2011	2012	512129
TE	510	2013	2013	512129
TE	510	2014	2014	512129
TE	510	2015	2018	512129
TE 511 Husqvarna Engine	510	2011	2011	512149
TE 511 Husqvarna Engine	510	2012	2013	512149
TE 511 Husqvarna Engine	510	2014	2014	512149
TE	510	2010	2010	512149
TE	510	2011	2012	512149
TE	510	2013	2013	512149
TE	510	2014	2014	512149
TE	510	2015	2018	512149
TE	510	2010	2010	512149
TE	510	2011	2012	512149
TE	510	2013	2013	512149
TE	510	2014	2014	512149
TE	510	2015	2018	512149
TXC	510	2004	2004	512047
TXC	510	2005	2005	512047
TXC	510	2006	2007	512047
TXC	510	2008	2009	512047
TXC 511	510	2011	2011	512129
TXC 511	510	2012	2012	512129

ATHENA				
Modèle	Cylindre	Année début	Année fin	Réf.
TXC	510	2010	2010	512129
TXC	510	2011	2012	512129
TXC	510	2013	2013	512129
TXC	510	2014	2018	512129
TXC 511	510	2011	2011	512149
TXC 511	510	2012	2012	512149
TXC 511	510	2013	2013	512149
TXC	510	2010	2010	512149
TXC	510	2011	2012	512149
TXC	510	2013	2013	512149
TXC	510	2014	2018	512149
SMR R	570	2004	2004	512047
SMR	570	2001	2001	512047
SMR	570	2002	2002	512047
SMR	570	2003	2004	512047
TE	570	2001	2001	512047
TE	570	2002	2002	512047
TE	570	2003	2003	512047
TE	570	2004	2004	512047
SM	610	1998	1998	512047
TC	610	1992	1992	512031
TC	610	1993	1994	512031
TC	610	1995	1995	512040
TC	610	1996	1996	512040
TC	610	1997	1997	512044
TC	610	1998	1998	512044
TC	610	2001	2001	512044
TC	610	2003	2004	512044
TC	610	2005	2006	512044
TC	610	1999	1999	512047
TC	610	1992	1992	512050
TC	610	1993	1994	512050
TE	610	1997	1997	512044
TE	610	1998	1998	512044
TE	610	1999	1999	512044
TE	610	2000	2000	512044
TE	610	2001	2001	512044
TE	610	2002	2004	512044
TE	610	2005	2005	512044
TE	610	2006	2006	512044
TE E	610	1998	1998	512047
SMR SEEL REPLICA	630	2004	2004	512047
KAWASAKI				
KX	125	1974	1977	512001
KX	125	1978	1979	480603

ATHENA				
Modèle	Cylindre	Année début	Année fin	Réf.
KX	125	1980	1981	512017
KX	125	1990	1990	512024
KX	125	1982	1982	512025
KX	125	1988	1988	512029
KX	125	1991	1991	512029
KX	125	1992	1992	512029
KX	125	1993	1993	512029
KX	125	1994	1994	512029
KX	125	1995	1995	512029
KX	125	1983	1983	512030
KX	125	1984	1984	512030
KX	125	1985	1985	512030
KX	125	1986	1986	512030
KX	125	1987	1987	512030
KX	125	1989	1989	512032
KX	125	1996	1996	512048
KX	125	1997	1997	512048
KX	125	1998	1998	512048
KX	125	1999	1999	512048
KX	125	2000	2000	512048
KX	125	2001	2001	512048
KX	125	1988	1988	486028
KX	125	1991	1991	486028
KX	125	1992	1992	486028
KX	125	1993	1993	486028
KX	125	1994	1994	486028
KX	125	1995	1995	486028
KX	125	1995	1995	512125
KX	125	1996	1996	512125
KX	125	1997	1997	512125
KX	125	1998	1998	512125
KX	125	1999	1999	512125
KX	125	2000	2000	512125
KX	125	2001	2001	512125
KX	125	2002	2002	512125
KX	125	2003	2003	512125
KX	125	2004	2005	512125
KX	125	2006	2006	512125
KX	125	2007	2007	512125
KX	125	2008	2008	512125
KX	125	2009	2011	512125
KX	125	2012	2018	512125
KX	125	1996	1996	512126
KX	125	1997	1997	512126
KX	125	1998	1998	512126

MOTEUR

CYCLE

PNEUMATIQUE

ATELIER

ACCESSOIRES

ÉLECTRICITÉ

FILTRATION

FREINAGE

TRANSMISSION

ATHENA				
Modèle	Cylindre	Année début	Année fin	Réf.
KX	125	1999	1999	512126
KX	125	2000	2000	512126
KX	125	2001	2001	512126
KX	125	1989	1989	512130
KX	125	1990	1990	512130
KX	125	1991	1991	512130
KX	125	1992	1992	512130
KX	125	1993	1993	512130
KX	125	1994	1994	512130
KX	125	1995	1995	512130
KX	125	1996	1996	512130
KX	125	1997	1997	512130
KX	125	1998	1998	512130
KX	125	1999	1999	512130
KX	125	2000	2000	512130
KX	125	2001	2001	512130
KX	125	2002	2002	512130
KX	125	2003	2003	512130
KX	125	2004	2005	512130
KX	125	2006	2006	512130
KX	125	2007	2007	512130
KX	125	2008	2008	512130
KX	125	2009	2011	512130
KX	125	2012	2018	512130
KX	125	2002	2002	512141
KX	125	2003	2003	512141
KX	125	2004	2005	512141
KX	125	2006	2006	512141
KX	125	2007	2007	512141
KX	125	2008	2008	512141
KX	125	2002	2002	512149
KX	125	2003	2003	512149
KX	125	2004	2005	512149
KX	125	2006	2006	512149
KX	125	2007	2007	512149
KX	125	2008	2008	512149
KLX L	140	2009	2012	480602
KLX	140	2009	2011	480602
KLX	140	2012	2012	480602
KDX	175	1980	1982	480603
KDX	200	1983	1985	512017
KDX	200	1993	1993	512024
KDX	200	1994	1994	512024
KDX	200	1995	1998	512029
KDX	200	1999	1999	512029

ATHENA				
Modèle	Cylindre	Année début	Année fin	Réf.
KDX	200	1986	1988	512030
KDX	200	1989	1992	512030
KDX	200	1995	1998	486028
KDX	200	1999	1999	486028
F11 M	250	1973	1973	512007
F11 M	250	1974	1975	512007
F11 M	250	1973	1973	512008
KDX	250	1979	1979	480603
KDX	250	1980	1980	512017
KDX	250	1981	1981	512017
KDX	250	1982	1982	512017
KDX	250	1983	1984	512017
KDX	250	1991	1994	512029
KDX	250	1991	1994	486028
KLX	250	1974	1978	480603
KLX	250	1979	1980	480603
KLX	250	1981	1981	480603
KLX	250	1982	1982	480603
KLX	250	1983	1983	480603
KLX	250	2009	2009	512029
KLX	250	2010	2010	512029
KLX	250	2011	2012	512029
KLX	250	1993	1996	512030
KLX	250	1997	1997	512030
KLX	250	1998	1998	512030
KLX	250	2009	2009	512125
KLX	250	2010	2010	512125
KLX	250	2011	2012	512125
KX	250	1974	1975	512008
KX	250	1976	1977	480603
KX	250	1978	1978	480603
KX	250	1979	1979	512017
KX	250	1980	1980	512017
KX	250	1981	1981	512017
KX	250	1990	1990	512024
KX	250	1982	1982	512025
KX	250	1988	1988	512029
KX	250	1991	1991	512029
KX	250	1992	1992	512029
KX	250	1993	1993	512029
KX	250	1994	1994	512029
KX	250	1995	1995	512029
KX	250	1983	1984	512030
KX	250	1985	1985	512030
KX	250	1986	1986	512030

ATHENA				
Modèle	Cylindre	Année début	Année fin	Réf.
KX	250	1987	1987	512030
KX	250	1989	1989	512032
KX F	250	2006	2006	512042
KX F	250	2007	2007	512042
KX F	250	2008	2008	512042
KX F	250	2009	2009	512042
KX F	250	2010	2010	512042
KX F	250	2011	2011	512042
KX F	250	2012	2012	512042
KX	250	1996	1996	512048
KX	250	1997	1997	512048
KX	250	1998	1998	512048
KX	250	1999	1999	512048
KX	250	2000	2000	512048
KX	250	2001	2001	512048
KX	250	1988	1988	486028
KX F	250	2006	2006	512123
KX F	250	2007	2007	512123
KX F	250	2008	2008	512123
KX F	250	2009	2009	512123
KX F	250	2010	2010	512123
KX F	250	2011	2011	512123
KX F	250	2012	2012	512123
KX	250	1995	1995	512125
KX	250	1996	1996	512125
KX	250	1997	1997	512125
KX	250	1998	1998	512125
KX	250	1999	1999	512125
KX	250	2000	2000	512125
KX	250	2001	2001	512125
KX	250	2002	2002	512125
KX	250	2003	2003	512125
KX	250	2004	2004	512125
KX	250	2005	2006	512125
KX	250	2007	2007	512125
KX	250	2008	2008	512125
KX	250	2009	2009	512125
KX	250	2010	2011	512125
KX	250	2012	2017	512125
KX	250	1996	1996	512126
KX	250	1997	1997	512126
KX	250	1998	1998	512126
KX	250	1999	1999	512126
KX	250	2000	2000	512126
KX	250	2001	2001	512126

ATHENA				
Modèle	Cylindre	Année début	Année fin	Réf.
KX	250	1989	1989	512130
KX	250	1990	1990	512130
KX	250	1991	1991	512130
KX	250	1992	1992	512130
KX	250	1993	1993	512130
KX	250	1994	1994	512130
KX	250	1995	1995	512130
KX	250	1996	1996	512130
KX	250	1997	1997	512130
KX	250	1998	1998	512130
KX	250	1999	1999	512130
KX	250	2000	2000	512130
KX	250	2001	2001	512130
KX	250	2002	2002	512130
KX	250	2003	2003	512130
KX	250	2004	2004	512130
KX	250	2005	2006	512130
KX	250	2007	2007	512130
KX	250	2008	2008	512130
KX	250	2009	2009	512130
KX	250	2010	2011	512130
KX	250	2012	2017	512130
KX F	250	2004	2004	512141
KX F	250	2005	2005	512141
KX	250	2002	2002	512141
KX	250	2003	2003	512141
KX	250	2004	2004	512141
KX	250	2005	2006	512141
KX	250	2007	2007	512141
KX	250	2008	2008	512141
KX F	250	2020	2020	512146
KX F	250	2004	2004	512149
KX F	250	2005	2005	512149
KX F	250	2020	2020	512149
KX	250	2002	2002	512149
KX	250	2003	2003	512149
KX	250	2004	2004	512149
KX	250	2005	2006	512149
KX	250	2007	2007	512149
KX	250	2008	2008	512149
KX F	250	2013	2013	512209
KX F	250	2014	2014	512209
KX F	250	2015	2015	512209
KX F	250	2016	2016	512209
KX F	250	2017	2017	512209

ATHENA				
Modèle	Cylindre	Année début	Année fin	Réf.
KX F	250	2018	2018	512209
KX F	250	2019	2019	512209
XL ENDURO	250	1986	1986	512036
KLX R	300	1997	1997	512029
KLX R	300	1998	1999	512029
KLX	300	1997	1999	512029
KLX R	300	1997	1997	486028
KLX R	300	1998	1999	486028
KLX	300	1997	1999	486028
KLX R	300	1997	1997	512125
KLX R	300	1998	1999	512125
KLX	300	1997	1999	512125
F12 MX / KX	450	1973	1973	512007
KLX R	450	2008	2008	512149
KLX R	450	2009	2009	512149
KLX R	450	2010	2011	512149
KLX R	450	2012	2012	512149
KLX R	450	2013	2014	512149
KLX R	450	2015	2015	512149
KLX R	450	2016	2016	512149
KLX R	450	2017	2017	512149
KLX R	450	2018	2019	512149
KLX R	450	2008	2008	512171
KLX R	450	2009	2009	512171
KLX R	450	2010	2011	512171
KLX R	450	2012	2012	512171
KLX R	450	2013	2014	512171
KLX R	450	2015	2015	512171
KLX R	450	2016	2016	512171
KLX R	450	2017	2017	512171
KLX R	450	2018	2019	512171
KX F	450	2015	2015	512041
KX F	450	2016	2016	512041
KX F	450	2017	2017	512041
KX F	450	2018	2018	512041
KX F	450	2019	2019	512041
KX F	450	2020	2020	512041
KX F	450	2015	2015	512124
KX F	450	2016	2016	512124
KX F	450	2017	2017	512124
KX F	450	2018	2018	512124
KX F	450	2019	2019	512124
KX F	450	2020	2020	512124
KX F	450	2006	2007	512141
KX F	450	2008	2008	512141

ATHENA				
Modèle	Cylindre	Année début	Année fin	Réf.
KX F	450	2009	2009	512141
KX F	450	2010	2011	512141
KX F	450	2012	2012	512141
KX F	450	2013	2013	512141
KX F	450	2014	2014	512141
KX F	450	2006	2007	512149
KX F	450	2008	2008	512149
KX F	450	2009	2009	512149
KX F	450	2010	2011	512149
KX F	450	2012	2012	512149
KX F	450	2013	2013	512149
KX F	450	2014	2014	512149
KX	500	1990	1990	512024
KX	500	1988	1988	512029
KX	500	1991	1991	512029
KX	500	1992	1993	512029
KX	500	1994	1994	512029
KX	500	1995	1995	512029
KX	500	1996	1996	512029
KX	500	1983	1983	512030
KX	500	1984	1984	512030
KX	500	1985	1985	512030
KX	500	1986	1986	512030
KX	500	1987	1987	512030
KX	500	1989	1989	512032
KX	500	1997	1998	512048
KX	500	1999	1999	512048
KX	500	2000	2002	512048
KX	500	2003	2003	512048
KX	500	2004	2004	512048
KX	500	1988	1988	486028
KX	500	1991	1991	486028
KX	500	1992	1993	486028
KX	500	1994	1994	486028
KX	500	1995	1995	486028
KX	500	1996	1996	486028
KX	500	1997	1998	512126
KX	500	1999	1999	512126
KX	500	2000	2002	512126
KX	500	2003	2003	512126
KX	500	2004	2004	512126
KX	500	1989	1989	512130
KX	500	1990	1990	512130
KX	500	1991	1991	512130
KX	500	1992	1993	512130

ATHENA				
Modèle	Cylindre	Année début	Année fin	Réf.
KX	500	1994	1994	512130
KX	500	1995	1995	512130
KX	500	1996	1996	512130
KX	500	1997	1998	512130
KX	500	1999	1999	512130
KX	500	2000	2002	512130
KX	500	2003	2003	512130
KX	500	2004	2004	512130
KX	500	2005	2018	512130
KAYABA				
41 MM. FORK TUBES		-	-	512024
43 MM. FORK TUBES		-	-	512030
46 MM. FORK TUBES		-	-	512048
48 MM. FORK TUBES		-	-	512141
KTM				
CROSS	125	1980	1982	512017
CROSS	125	1983	1983	512017
EGS	125	1995	1997	512040
EGS	125	1998	1998	512040
EGS	125	1999	1999	512040
EGS	125	2000	2000	512128
EGS	125	2001	2001	512128
EGS	125	2002	2002	512144
EGS	125	2003	2003	512144
EGS	125	2004	2004	512144
EGS	125	2002	2002	512146
EGS	125	2003	2003	512146
EGS	125	2004	2004	512146
EGS	125	2005	2005	512172
EGS	125	2006	2007	512172
EGS	125	2008	2009	512172
EGS	125	2010	2012	512172
EGS	125	2013	2018	512172
EGS	125	2005	2005	512173
EGS	125	2006	2007	512173
EGS	125	2008	2009	512173
EGS	125	2010	2012	512173
EGS	125	2013	2018	512173
EXC TXC	125	1992	1992	512037
EXC	125	1993	1993	512037
EXC	125	1994	1994	512037
EXC	125	1995	1997	512040
EXC	125	1998	1998	512040
EXC	125	1999	1999	512040
EXC	125	2000	2000	512144

ATHENA				
Modèle	Cylindre	Année début	Année fin	Réf.
EXC	125	2001	2001	512144
EXC	125	2002	2002	512144
EXC	125	2003	2003	512144
EXC	125	2004	2004	512144
EXC	125	2000	2000	512146
EXC	125	2001	2001	512146
EXC	125	2002	2002	512146
EXC	125	2003	2003	512146
EXC	125	2004	2004	512146
EXC SIX DAYS	125	2006	2006	512172
EXC SIX DAYS	125	2007	2009	512172
EXC SIX DAYS	125	2010	2012	512172
EXC SIX DAYS	125	2013	2013	512172
EXC SIX DAYS	125	2014	2014	512172
EXC	125	2005	2005	512172
EXC	125	2006	2006	512172
EXC	125	2007	2007	512172
EXC	125	2008	2008	512172
EXC	125	2009	2009	512172
EXC	125	2010	2010	512172
EXC	125	2011	2011	512172
EXC	125	2012	2013	512172
EXC	125	2014	2015	512172
EXC	125	2016	2016	512172
EXC SIX DAYS	125	2006	2006	512173
EXC SIX DAYS	125	2007	2009	512173
EXC SIX DAYS	125	2010	2012	512173
EXC	125	2005	2005	512173
EXC	125	2006	2006	512173
EXC	125	2007	2007	512173
EXC	125	2008	2008	512173
EXC	125	2009	2009	512173
EXC	125	2010	2010	512173
EXC	125	2011	2011	512173
EXC	125	2012	2013	512173
EXC	125	2014	2015	512173
EXC	125	2016	2016	512173
GS LC	125	1983	1983	480623
GS	125	1984	1984	480623
GS	125	1986	1986	512036
GS	125	1987	1987	512037
GS	125	1988	1988	512037
GS	125	1989	1990	512037
GS	125	1991	1991	512037
GS	125	1992	1993	512037

MOTEUR

CYCLE

PNEUMATIQUE

ATELIER

ACCESSOIRES

ÉLECTRICITÉ

FILTRATION

FREINAGE

TRANSMISSION

ATHENA				
Modèle	Cylindre	Année début	Année fin	Réf.
GS	125	1994	1994	512037
GS	125	1995	1995	512037
GS	125	1999	1999	512040
MC CROSS	125	1984	1985	512036
MX	125	1986	1986	512036
MX	125	1987	1987	512037
MX	125	1988	1988	512037
MX	125	1989	1990	512037
MX	125	1991	1991	512037
MX	125	1992	1993	512037
MX	125	1994	1994	512037
MX	125	1999	1999	512040
MXC	125	2000	2000	512144
MXC	125	2001	2001	512144
MXC	125	2002	2003	512144
MXC	125	2004	2004	512144
MXC	125	2000	2000	512146
MXC	125	2001	2001	512146
MXC	125	2002	2003	512146
MXC	125	2004	2004	512146
MXC	125	2005	2005	512172
MXC	125	2006	2009	512172
MXC	125	2010	2018	512172
MXC	125	2005	2005	512173
MXC	125	2006	2009	512173
MXC	125	2010	2018	512173
SX	125	1987	1992	512037
SX	125	1993	1993	512037
SX	125	1994	1994	512037
SX	125	1999	1999	512040
SX	125	2000	2000	512144
SX	125	2001	2001	512144
SX	125	2002	2002	512144
SX	125	2003	2003	512144
SX	125	2004	2004	512144
SX	125	2000	2000	512146
SX	125	2001	2001	512146
SX	125	2002	2002	512146
SX	125	2003	2003	512146
SX	125	2004	2004	512146
SX	125	2005	2005	512172
SX	125	2006	2006	512172
SX	125	2007	2007	512172
SX	125	2008	2008	512172
SX	125	2009	2009	512172

ATHENA				
Modèle	Cylindre	Année début	Année fin	Réf.
SX	125	2010	2010	512172
SX	125	2011	2011	512172
SX	125	2012	2012	512172
SX	125	2013	2013	512172
SX	125	2014	2014	512172
SX	125	2015	2015	512172
SX	125	2016	2016	512172
SX	125	2017	2017	512172
SX	125	2018	2018	512172
SX	125	2019	2019	512172
SX	125	2020	2020	512172
SX	125	2005	2005	512173
SX	125	2006	2006	512173
SX	125	2007	2007	512173
SX	125	2008	2008	512173
SX	125	2009	2009	512173
SX	125	2010	2010	512173
SX	125	2011	2011	512173
SX	125	2012	2012	512173
SX	125	2013	2013	512173
SX	125	2014	2014	512173
SX	125	2015	2015	512173
SX	125	2016	2016	512173
SX	125	2017	2017	512173
SX	125	2018	2018	512173
SX	125	2019	2019	512173
SX	125	2020	2020	512173
XC ENDURO	125	1986	1986	512036
XC-W	125	2017	2017	512172
XC-W	125	2018	2018	512172
XC-W	125	2019	2019	512172
XC-W	125	2017	2017	512173
XC-W	125	2018	2018	512173
XC-W	125	2019	2019	512173
SX	144	2008	2008	512172
SX	144	2009	2009	512172
SX	144	2008	2008	512173
SX	144	2009	2009	512173
EXC	150	2020	2020	512172
EXC	150	2020	2020	512173
SX	150	2009	2009	512172
SX	150	2010	2010	512172
SX	150	2011	2012	512172
SX	150	2013	2013	512172
SX	150	2014	2014	512172

ATHENA				
Modèle	Cylindre	Année début	Année fin	Réf.
SX	150	2015	2015	512172
SX	150	2016	2016	512172
SX	150	2017	2017	512172
SX	150	2018	2018	512172
SX	150	2019	2019	512172
SX	150	2020	2020	512172
SX	150	2009	2009	512173
SX	150	2010	2010	512173
SX	150	2011	2012	512173
SX	150	2013	2013	512173
SX	150	2014	2014	512173
SX	150	2015	2015	512173
SX	150	2016	2016	512173
SX	150	2017	2017	512173
SX	150	2018	2018	512173
SX	150	2019	2019	512173
SX	150	2020	2020	512173
XC	150	2009	2009	512172
XC	150	2010	2010	512172
XC	150	2011	2012	512172
XC	150	2013	2013	512172
XC	150	2014	2014	512172
XC	150	2009	2009	512173
XC	150	2010	2010	512173
XC	150	2011	2012	512173
XC	150	2013	2013	512173
XC	150	2014	2014	512173
XC-W	150	2017	2017	512172
XC-W	150	2018	2018	512172
XC-W	150	2019	2019	512172
XC-W	150	2020	2020	512172
XC-W	150	2017	2017	512173
XC-W	150	2018	2018	512173
XC-W	150	2019	2019	512173
XC-W	150	2020	2020	512173
EGS	200	1998	1998	512040
EGS	200	1999	1999	512040
EGS	200	2000	2000	512040
EGS	200	2002	2002	512144
EGS	200	2003	2003	512144
EGS	200	2004	2004	512144
EGS	200	2002	2002	512146
EGS	200	2003	2003	512146
EGS	200	2004	2004	512146
EGS	200	2005	2005	512146
EGS	200	2004	2004	512146
EGS	200	2005	2005	512172

ATHENA				
Modèle	Cylindre	Année début	Année fin	Réf.
EGS	200	2006	2007	512172
EGS	200	2008	2010	512172
EGS	200	2011	2011	512172
EGS	200	2012	2012	512172
EGS	200	2013	2015	512172
EGS	200	2016	2018	512172
EGS	200	2005	2005	512173
EGS	200	2006	2007	512173
EGS	200	2008	2010	512173
EGS	200	2011	2011	512173
EGS	200	2012	2012	512173
EGS	200	2013	2015	512173
EGS	200	2016	2018	512173
EXC	200	1998	1998	512040
EXC	200	1999	1999	512040
EXC	200	2000	2000	512144
EXC	200	2001	2001	512144
EXC	200	2002	2002	512144
EXC	200	2003	2003	512144
EXC	200	2004	2004	512144
EXC	200	2000	2000	512146
EXC	200	2001	2001	512146
EXC	200	2002	2002	512146
EXC	200	2003	2003	512146
EXC	200	2004	2004	512146
EXC	200	2005	2005	512172
EXC	200	2006	2006	512172
EXC	200	2007	2007	512172
EXC	200	2008	2008	512172
EXC	200	2009	2009	512172
EXC	200	2010	2010	512172
EXC	200	2011	2011	512172
EXC	200	2012	2012	512172
EXC	200	2013	2013	512172
EXC	200	2014	2015	512172
EXC	200	2016	2016	512172
EXC	200	2005	2005	512173
EXC	200	2006	2006	512173
EXC	200	2007	2007	512173
EXC	200	2008	2008	512173
EXC	200	2009	2009	512173
EXC	200	2010	2010	512173
EXC	200	2011	2011	512173
EXC	200	2012	2012	512173
EXC	200	2013	2013	512173

ATHENA				
Modèle	Cylindre	Année début	Année fin	Réf.
EXC	200	2014	2015	512173
EXC	200	2016	2016	512173
GS	200	1999	1999	512040
MX	200	1999	1999	512040
MXC	200	2002	2002	512144
MXC	200	2003	2003	512144
MXC	200	2004	2004	512144
MXC	200	2002	2002	512146
MXC	200	2003	2003	512146
MXC	200	2004	2004	512146
MXC	200	2005	2005	512172
MXC	200	2006	2010	512172
MXC	200	2011	2011	512172
MXC	200	2012	2018	512172
MXC	200	2005	2005	512173
MXC	200	2006	2010	512173
MXC	200	2011	2011	512173
MXC	200	2012	2018	512173
SX	200	1999	1999	512040
SX	200	2000	2000	512040
SX	200	2000	2000	512144
SX	200	2001	2001	512144
SX	200	2002	2002	512144
SX	200	2003	2003	512144
SX	200	2004	2004	512144
SX	200	2001	2001	512146
SX	200	2002	2002	512146
SX	200	2003	2003	512146
SX	200	2004	2004	512146
SX	200	2005	2005	512172
SX	200	2006	2006	512172
SX	200	2007	2007	512172
SX	200	2008	2010	512172
SX	200	2011	2011	512172
SX	200	2012	2012	512172
SX	200	2005	2005	512173
SX	200	2006	2006	512173
SX	200	2007	2007	512173
SX	200	2008	2010	512173
SX	200	2011	2011	512173
SX	200	2012	2012	512173
XC-W	200	2006	2006	512172
XC-W	200	2007	2007	512172
XC-W	200	2008	2008	512172
XC-W	200	2009	2009	512172

ATHENA				
Modèle	Cylindre	Année début	Année fin	Réf.
XC-W	200	2010	2010	512172
XC-W	200	2011	2011	512172
XC-W	200	2012	2012	512172
XC-W	200	2013	2013	512172
XC-W	200	2014	2014	512172
XC-W	200	2015	2015	512172
XC-W	200	2006	2006	512173
XC-W	200	2007	2007	512173
XC-W	200	2008	2008	512173
XC-W	200	2009	2009	512173
XC-W	200	2010	2010	512173
XC-W	200	2011	2011	512173
XC-W	200	2012	2012	512173
XC-W	200	2013	2013	512173
XC-W	200	2014	2014	512173
XC-W	200	2015	2015	512173
CROSS	250	1982	1982	480623
EGS	250	1990	1993	512037
EGS	250	1994	1994	512037
EGS	250	1995	1995	512037
EGS	250	1996	1997	512040
EGS	250	1998	1998	512043
EGS	250	1999	1999	512043
EUROPE	250	-	-	512037
EXC TXC	250	1992	1992	512037
EXC	250	1993	1993	512037
EXC	250	1994	1994	512037
EXC	250	1995	1995	512037
EXC	250	1998	1998	512043
EXC	250	1999	1999	512043
EXC	250	2000	2000	512128
EXC	250	2001	2001	512128
EXC RACING	250	2003	2003	512144
EXC RACING	250	2004	2004	512144
EXC	250	2000	2000	512144
EXC	250	2001	2001	512144
EXC	250	2002	2002	512144
EXC	250	2003	2003	512144
EXC	250	2004	2004	512144
EXC RACING	250	2003	2003	512146
EXC RACING	250	2004	2004	512146
EXC	250	2000	2000	512146
EXC	250	2001	2001	512146
EXC	250	2002	2002	512146
EXC	250	2003	2003	512146

ATHENA				
Modèle	Cylindre	Année début	Année fin	Réf.
EXC	250	2004	2004	512146
EXC RACING	250	2005	2005	512172
EXC RACING	250	2006	2006	512172
EXC SIX DAYS	250	2013	2013	512172
EXC SIX DAYS	250	2014	2015	512172
EXC SIX DAYS	250	2016	2016	512172
EXC TPI	250	2018	2018	512172
EXC TPI	250	2019	2019	512172
EXC TPI	250	2020	2020	512172
EXC	250	2005	2005	512172
EXC	250	2006	2006	512172
EXC	250	2007	2007	512172
EXC	250	2008	2008	512172
EXC	250	2009	2009	512172
EXC	250	2011	2011	512172
EXC	250	2012	2012	512172
EXC	250	2013	2013	512172
EXC	250	2016	2016	512172
EXC	250	2017	2017	512172
EXC	250	2018	2018	512172
EXC	250	2019	2019	512172
EXC	250	2020	2020	512172
EXC RACING	250	2005	2005	512173
EXC RACING	250	2006	2006	512173
EXC SIX DAYS	250	2013	2013	512173
EXC SIX DAYS	250	2014	2015	512173
EXC SIX DAYS	250	2016	2016	512173
EXC TPI	250	2018	2018	512173
EXC TPI	250	2019	2019	512173
EXC TPI	250	2020	2020	512173
EXC	250	2005	2005	512173
EXC	250	2006	2006	512173
EXC	250	2007	2007	512173
EXC	250	2008	2008	512173
EXC	250	2009	2009	512173
EXC	250	2011	2011	512173
EXC	250	2012	2012	512173
EXC	250	2013	2013	512173
EXC	250	2016	2016	512173
EXC	250	2017	2017	512173
EXC	250	2018	2018	512173
EXC	250	2019	2019	512173
EXC	250	2020	2020	512173
EXC-F SIX DAYS	250	2013	2013	512172
EXC-F SIX DAYS	250	2014	2014	512172

ATHENA				
Modèle	Cylindre	Année début	Année fin	Réf.
EXC-F	250	2005	2005	512172
EXC-F	250	2006	2006	512172
EXC-F	250	2007	2007	512172
EXC-F	250	2008	2008	512172
EXC-F	250	2009	2009	512172
EXC-F	250	2010	2010	512172
EXC-F	250	2011	2011	512172
EXC-F	250	2012	2012	512172
EXC-F	250	2013	2013	512172
EXC-F	250	2014	2014	512172
EXC-F	250	2015	2015	512172
EXC-F	250	2016	2016	512172
EXC-F	250	2017	2018	512172
EXC-F	250	2019	2019	512172
EXC-F	250	2020	2020	512172
EXC-F SIX DAYS	250	2013	2013	512173
EXC-F SIX DAYS	250	2014	2014	512173
EXC-F	250	2005	2005	512173
EXC-F	250	2006	2006	512173
EXC-F	250	2007	2007	512173
EXC-F	250	2008	2008	512173
EXC-F	250	2009	2009	512173
EXC-F	250	2010	2010	512173
EXC-F	250	2011	2011	512173
EXC-F	250	2012	2012	512173
EXC-F	250	2013	2013	512173
EXC-F	250	2014	2014	512173
EXC-F	250	2015	2015	512173
EXC-F	250	2016	2016	512173
EXC-F	250	2017	2018	512173
EXC-F	250	2019	2019	512173
EXC-F	250	2020	2020	512173
FREERIDE R	250	2014	2014	512143
FREERIDE R	250	2015	2016	512143
FREERIDE R	250	2017	2017	512143
FREERIDE R	250	2014	2014	512145
FREERIDE R	250	2015	2016	512145
FREERIDE R	250	2017	2017	512145
GS	250	1983	1983	480623
GS	250	1984	1985	480623
GS	250	1984	1985	512036
GS	250	1986	1986	512036
GS	250	1993	1993	512037
GS	250	1999	1999	512043
MARZOCCHI	250	1996	1997	512040

MOTEUR

CYCLE

PNEUMATIQUE

ATELIER

ACCESSOIRES

ÉLECTRICITÉ

FILTRATION

FREINAGE

TRANSMISSION

ATHENA				
Modèle	Cylindre	Année début	Année fin	Réf.
MC CROSS	250	1983	1983	480623
MC CROSS	250	1984	1984	480623
MC CROSS	250	1984	1984	512036
MC CROSS	250	1985	1985	512036
MX	250	1986	1986	512036
MX	250	1992	1993	512037
MX	250	1994	1994	512037
MX	250	1995	1995	512037
MX	250	1999	1999	512043
MXC	250	2002	2003	512144
MXC	250	2002	2003	512146
SX	250	1998	1998	512043
SX	250	1999	1999	512043
SX	250	2000	2000	512144
SX	250	2001	2001	512144
SX	250	2002	2002	512144
SX	250	2003	2003	512144
SX	250	2004	2004	512144
SX	250	2000	2000	512146
SX	250	2001	2001	512146
SX	250	2002	2002	512146
SX	250	2003	2003	512146
SX	250	2004	2004	512146
SX	250	2005	2005	512172
SX	250	2006	2006	512172
SX	250	2007	2007	512172
SX	250	2008	2008	512172
SX	250	2009	2009	512172
SX	250	2010	2010	512172
SX	250	2011	2012	512172
SX	250	2013	2013	512172
SX	250	2014	2015	512172
SX	250	2016	2016	512172
SX	250	2017	2017	512172
SX	250	2018	2018	512172
SX	250	2019	2019	512172
SX	250	2020	2020	512172
SX	250	2005	2005	512173
SX	250	2006	2006	512173
SX	250	2007	2007	512173
SX	250	2008	2008	512173
SX	250	2009	2009	512173
SX	250	2010	2010	512173
SX	250	2011	2012	512173
SX	250	2013	2013	512173

ATHENA				
Modèle	Cylindre	Année début	Année fin	Réf.
SX	250	2014	2015	512173
SX	250	2016	2016	512173
SX	250	2017	2017	512173
SX	250	2018	2018	512173
SX	250	2019	2019	512173
SX	250	2020	2020	512173
SX-F	250	2006	2006	512172
SX-F	250	2007	2007	512172
SX-F	250	2008	2008	512172
SX-F	250	2009	2009	512172
SX-F	250	2010	2010	512172
SX-F	250	2011	2011	512172
SX-F	250	2012	2012	512172
SX-F	250	2013	2013	512172
SX-F	250	2014	2014	512172
SX-F	250	2015	2015	512172
SX-F	250	2016	2016	512172
SX-F	250	2017	2017	512172
SX-F	250	2018	2018	512172
SX-F	250	2019	2019	512172
SX-F	250	2020	2020	512172
SX-F	250	2006	2006	512173
SX-F	250	2007	2007	512173
SX-F	250	2008	2008	512173
SX-F	250	2009	2009	512173
SX-F	250	2010	2010	512173
SX-F	250	2011	2011	512173
SX-F	250	2012	2012	512173
SX-F	250	2013	2013	512173
SX-F	250	2014	2014	512173
SX-F	250	2015	2015	512173
SX-F	250	2016	2016	512173
SX-F	250	2017	2017	512173
SX-F	250	2018	2018	512173
SX-F	250	2019	2019	512173
SX-F	250	2020	2020	512173
XC	250	2008	2008	512172
XC	250	2009	2009	512172
XC	250	2010	2010	512172
XC	250	2011	2011	512172
XC	250	2012	2012	512172
XC	250	2013	2013	512172
XC	250	2014	2015	512172
XC	250	2016	2016	512172
XC	250	2017	2017	512172

ATHENA				
Modèle	Cylindre	Année début	Année fin	Réf.
XC	250	2018	2018	512172
XC	250	2019	2019	512172
XC	250	2020	2020	512172
XC	250	2008	2008	512173
XC	250	2009	2009	512173
XC	250	2010	2010	512173
XC	250	2011	2011	512173
XC	250	2012	2012	512173
XC	250	2013	2013	512173
XC	250	2014	2015	512173
XC	250	2016	2016	512173
XC	250	2017	2017	512173
XC	250	2018	2018	512173
XC	250	2019	2019	512173
XC	250	2020	2020	512173
XC-F	250	2008	2008	512172
XC-F	250	2009	2009	512172
XC-F	250	2010	2010	512172
XC-F	250	2011	2012	512172
XC-F	250	2013	2013	512172
XC-F	250	2014	2014	512172
XC-F	250	2015	2015	512172
XC-F	250	2016	2016	512172
XC-F	250	2017	2018	512172
XC-F	250	2019	2019	512172
XC-F	250	2020	2020	512172
XC-F	250	2008	2008	512173
XC-F	250	2009	2009	512173
XC-F	250	2010	2010	512173
XC-F	250	2011	2012	512173
XC-F	250	2013	2013	512173
XC-F	250	2014	2014	512173
XC-F	250	2015	2015	512173
XC-F	250	2016	2016	512173
XC-F	250	2017	2018	512173
XC-F	250	2019	2019	512173
XC-F	250	2020	2020	512173
XCF-W	250	2008	2008	512172
XCF-W	250	2009	2009	512172
XCF-W	250	2010	2010	512172
XCF-W	250	2011	2011	512172
XCF-W	250	2012	2012	512172
XCF-W	250	2013	2013	512172
XCF-W	250	2014	2014	512172
XCF-W	250	2015	2015	512172

ATHENA				
Modèle	Cylindre	Année début	Année fin	Réf.
XCF-W	250	2008	2008	512173
XCF-W	250	2009	2009	512173
XCF-W	250	2010	2010	512173
XCF-W	250	2011	2011	512173
XCF-W	250	2012	2012	512173
XCF-W	250	2013	2013	512173
XCF-W	250	2014	2014	512173
XCF-W	250	2015	2015	512173
XC-W	250	2008	2009	512172
XC-W	250	2010	2010	512172
XC-W	250	2011	2011	512172
XC-W	250	2012	2012	512172
XC-W	250	2013	2013	512172
XC-W	250	2014	2014	512172
XC-W	250	2015	2015	512172
XC-W	250	2016	2016	512172
XC-W	250	2017	2017	512172
XC-W	250	2018	2018	512172
XC-W	250	2019	2019	512172
XC-W	250	2020	2020	512172
XC-W	250	2008	2009	512173
XC-W	250	2010	2010	512173
XC-W	250	2011	2011	512173
XC-W	250	2012	2012	512173
XC-W	250	2013	2013	512173
XC-W	250	2014	2014	512173
XC-W	250	2015	2015	512173
XC-W	250	2016	2016	512173
XC-W	250	2017	2017	512173
XC-W	250	2018	2018	512173
XC-W	250	2019	2019	512173
XC-W	250	2020	2020	512173
XC-WE	250	2008	2008	512172
XC-WE	250	2009	2018	512172
XC-WE	250	2008	2008	512173
XC-WE	250	2009	2018	512173
EGS	300	1992	1992	512037
EXC TCX	300	1992	1992	512037
EXC	300	1993	1993	512037
EXC	300	1994	1994	512037
EXC	300	1998	1998	512043
EXC	300	1999	1999	512043
EXC	300	2000	2000	512144
EXC	300	2001	2001	512144
EXC	300	2002	2002	512144

ATHENA				
Modèle	Cylindre	Année début	Année fin	Réf.
EXC	300	2003	2003	512144
EXC	300	2004	2004	512144
EXC	300	2000	2000	512146
EXC	300	2001	2001	512146
EXC	300	2002	2002	512146
EXC	300	2003	2003	512146
EXC	300	2004	2004	512146
EXC SIX DAYS	300	2013	2013	512172
EXC SIX DAYS	300	2014	2015	512172
EXC TPI	300	2018	2018	512172
EXC TPI	300	2019	2019	512172
EXC TPI	300	2020	2020	512172
EXC	300	2008	2008	512172
EXC	300	2009	2009	512172
EXC	300	2010	2010	512172
EXC	300	2011	2011	512172
EXC	300	2012	2012	512172
EXC	300	2013	2013	512172
EXC	300	2014	2014	512172
EXC	300	2015	2015	512172
EXC	300	2016	2016	512172
EXC	300	2017	2017	512172
EXC	300	2018	2018	512172
EXC	300	2019	2019	512172
EXC	300	2020	2020	512172
EXC SIX DAYS	300	2013	2013	512173
EXC SIX DAYS	300	2014	2015	512173
EXC TPI	300	2018	2018	512173
EXC TPI	300	2019	2019	512173
EXC TPI	300	2020	2020	512173
EXC	300	2008	2008	512173
EXC	300	2009	2009	512173
EXC	300	2010	2010	512173
EXC	300	2011	2011	512173
EXC	300	2012	2012	512173
EXC	300	2013	2013	512173
EXC	300	2014	2014	512173
EXC	300	2015	2015	512173
EXC	300	2016	2016	512173
EXC	300	2017	2017	512173
EXC	300	2018	2018	512173
EXC	300	2019	2019	512173
EXC	300	2020	2020	512173
GS XC	300	1986	1986	512036
GS	300	1985	1986	512036

ATHENA				
Modèle	Cylindre	Année début	Année fin	Réf.
GS	300	1993	1993	512037
GS	300	1995	1995	512037
MX	300	1985	1985	512036
MX	300	1992	1994	512037
MXC	300	2004	2004	512144
MXC	300	2004	2004	512146
MXC	300	2005	2005	512172
MXC	300	2006	2006	512172
MXC	300	2007	2007	512172
MXC	300	2005	2005	512173
MXC	300	2006	2006	512173
MXC	300	2007	2007	512173
SX	300	1993	1993	512037
SX	300	1998	1998	512043
SX	300	1999	1999	512043
SX	300	2000	2001	512129
XC	300	2008	2008	512172
XC	300	2009	2009	512172
XC	300	2010	2010	512172
XC	300	2011	2012	512172
XC	300	2013	2013	512172
XC	300	2014	2014	512172
XC	300	2016	2016	512172
XC	300	2017	2017	512172
XC	300	2018	2018	512172
XC	300	2019	2019	512172
XC	300	2020	2020	512172
XC	300	2008	2008	512173
XC	300	2009	2009	512173
XC	300	2010	2010	512173
XC	300	2011	2012	512173
XC	300	2013	2013	512173
XC	300	2014	2014	512173
XC	300	2016	2016	512173
XC	300	2017	2017	512173
XC	300	2018	2018	512173
XC	300	2019	2019	512173
XC	300	2020	2020	512173
XC-W	300	2008	2009	512172
XC-W	300	2010	2010	512172
XC-W	300	2011	2011	512172
XC-W	300	2012	2013	512172
XC-W	300	2014	2015	512172
XC-W	300	2016	2016	512172
XC-W	300	2017	2017	512172

ATHENA				
Modèle	Cylindre	Année début	Année fin	Réf.
XC-W	300	2018	2018	512172
XC-W	300	2019	2019	512172
XC-W	300	2020	2020	512172
XC-W	300	2008	2009	512173
XC-W	300	2010	2010	512173
XC-W	300	2011	2011	512173
XC-W	300	2012	2013	512173
XC-W	300	2014	2015	512173
XC-W	300	2016	2016	512173
XC-W	300	2017	2017	512173
XC-W	300	2018	2018	512173
XC-W	300	2019	2019	512173
XC-W	300	2020	2020	512173
350 4T	350	1993	1993	512037
COUNTRY E	350	1985	1985	480623
EXC-F SIX DAYS	350	2013	2013	512172
EXC-F SIX DAYS	350	2014	2014	512172
EXC-F SIX DAYS	350	2015	2015	512172
EXC-F SIX DAYS	350	2016	2016	512172
EXC-F	350	2012	2012	512172
EXC-F	350	2013	2013	512172
EXC-F	350	2014	2014	512172
EXC-F	350	2015	2015	512172
EXC-F	350	2016	2016	512172
EXC-F	350	2017	2018	512172
EXC-F	350	2019	2019	512172
EXC-F	350	2020	2020	512172
EXC-F SIX DAYS	350	2013	2013	512173
EXC-F SIX DAYS	350	2014	2014	512173
EXC-F SIX DAYS	350	2015	2015	512173
EXC-F SIX DAYS	350	2016	2016	512173
EXC-F	350	2012	2012	512173
EXC-F	350	2013	2013	512173
EXC-F	350	2014	2014	512173
EXC-F	350	2015	2015	512173
EXC-F	350	2016	2016	512173
EXC-F	350	2017	2018	512173
EXC-F	350	2019	2019	512173
EXC-F	350	2020	2020	512173
FREERIDE	350	2013	2013	512143
FREERIDE	350	2014	2014	512143
FREERIDE	350	2015	2017	512143
FREERIDE	350	2013	2013	512145
FREERIDE	350	2014	2014	512145
FREERIDE	350	2015	2017	512145

ATHENA				
Modèle	Cylindre	Année début	Année fin	Réf.
GS	350	1983	1983	480623
SX-F	350	2011	2012	512172
SX-F	350	2013	2013	512172
SX-F	350	2014	2014	512172
SX-F	350	2015	2015	512172
SX-F	350	2016	2016	512172
SX-F	350	2017	2017	512172
SX-F	350	2018	2018	512172
SX-F	350	2019	2019	512172
SX-F	350	2020	2020	512172
SX-F	350	2011	2012	512173
SX-F	350	2013	2013	512173
SX-F	350	2014	2014	512173
SX-F	350	2015	2015	512173
SX-F	350	2016	2016	512173
SX-F	350	2017	2017	512173
SX-F	350	2018	2018	512173
SX-F	350	2019	2019	512173
SX-F	350	2020	2020	512173
XC-F	350	2012	2012	512172
XC-F	350	2013	2013	512172
XC-F	350	2014	2014	512172
XC-F	350	2015	2015	512172
XC-F	350	2016	2016	512172
XC-F	350	2017	2018	512172
XC-F	350	2019	2019	512172
XC-F	350	2020	2020	512172
XC-F	350	2012	2012	512173
XC-F	350	2013	2013	512173
XC-F	350	2014	2014	512173
XC-F	350	2015	2015	512173
XC-F	350	2016	2016	512173
XC-F	350	2017	2018	512173
XC-F	350	2019	2019	512173
XC-F	350	2020	2020	512173
XC-F	350	2012	2012	512172
XC-F	350	2013	2013	512172
XC-F	350	2014	2014	512172
XC-F	350	2015	2015	512172
XC-F	350	2016	2016	512172
XC-F	350	2017	2018	512172
XC-F	350	2019	2019	512172
XC-F	350	2020	2020	512172
XCF-W	350	2012	2012	512172
XCF-W	350	2013	2013	512172
XCF-W	350	2014	2014	512172
XCF-W	350	2015	2015	512172
XCF-W	350	2012	2012	512173
XCF-W	350	2013	2013	512173
XCF-W	350	2014	2014	512173
XCF-W	350	2015	2015	512173
XCF-W	350	2012	2012	512173
XCF-W	350	2013	2013	512173
XCF-W	350	2014	2014	512173
XCF-W	350	2015	2015	512173
EGS	360	1995	1995	512043
EGS	360	1997	1997	512043

MOTEUR

CYCLE

PNEUMATIQUE

ATELIER

ACCESSOIRES

ÉLECTRICITÉ

FILTRATION

FREINAGE

TRANSMISSION

ATHENA				
Modèle	Cylindre	Année début	Année fin	Réf.
EXC	360	1995	1995	512043
EXC	360	1997	1997	512043
MARZOCCHI	360	1997	1997	512040
SX	360	1995	1995	512043
SX	360	1996	1996	512043
SX	360	1997	1997	512043
EGS	380	1998	1998	512043
EXC	380	1998	1998	512043
EXC	380	1999	1999	512043
EXC	380	2000	2000	512128
EXC	380	2001	2001	512128
SX	380	1998	1998	512043
SX	380	1999	1999	512043
SX	380	2000	2000	512129
SX	380	2001	2001	512129
400 4T	400	1993	1993	512037
EXC RACING	400	1999	1999	512043
EXC RACING	400	2000	2000	512128
EXC RACING	400	2001	2001	512128
EXC RACING	400	2002	2002	512144
EXC RACING	400	2003	2003	512144
EXC RACING	400	2004	2004	512144
EXC RACING	400	2002	2002	512146
EXC RACING	400	2003	2003	512146
EXC RACING	400	2004	2004	512146
EXC RACING	400	2005	2005	512172
EXC RACING	400	2007	2007	512172
EXC	400	2005	2005	512172
EXC	400	2006	2006	512172
EXC	400	2007	2007	512172
EXC	400	2008	2008	512172
EXC	400	2009	2009	512172
EXC	400	2010	2010	512172
EXC	400	2011	2011	512172
EXC RACING	400	2005	2005	512173
EXC RACING	400	2007	2007	512173
EXC	400	2005	2005	512173
EXC	400	2006	2006	512173
EXC	400	2007	2007	512173
EXC	400	2008	2008	512173
EXC	400	2009	2009	512173
EXC	400	2010	2010	512173
EXC	400	2011	2011	512173
SX RACING	400	1999	1999	512043
SX RACING	400	2000	2001	512128

ATHENA				
Modèle	Cylindre	Année début	Année fin	Réf.
SX RACING	400	2002	2002	512144
SX RACING	400	2003	2004	512144
SX RACING	400	2002	2002	512146
SX RACING	400	2003	2004	512146
SX RACING	400	2005	2006	512172
SX RACING	400	2007	2007	512172
SX RACING	400	2005	2006	512173
SX RACING	400	2007	2007	512173
XCW	400	2008	2008	512172
XCW	400	2009	2009	512172
XCW	400	2010	2010	512172
XCW	400	2011	2011	512172
XCW	400	2008	2008	512173
XCW	400	2009	2009	512173
XCW	400	2010	2010	512173
XCW	400	2011	2011	512173
GS ENDURO	420	1984	1984	512036
EXC RACING	450	2002	2002	512144
EXC RACING	450	2003	2003	512144
EXC RACING	450	2004	2004	512144
EXC RACING	450	2002	2002	512146
EXC RACING	450	2003	2003	512146
EXC RACING	450	2004	2004	512146
EXC RACING	450	2005	2005	512172
EXC RACING	450	2006	2006	512172
EXC RACING	450	2007	2007	512172
EXC SIX DAYS	450	2012	2012	512172
EXC SIX DAYS	450	2013	2013	512172
EXC SIX DAYS	450	2014	2014	512172
EXC SIX DAYS	450	2015	2015	512172
EXC SIX DAYS	450	2016	2016	512172
EXC RACING	450	2005	2005	512173
EXC RACING	450	2006	2006	512173
EXC RACING	450	2007	2007	512173
EXC SIX DAYS	450	2012	2012	512173
EXC SIX DAYS	450	2013	2013	512173
EXC SIX DAYS	450	2014	2014	512173
EXC SIX DAYS	450	2015	2015	512173
EXC SIX DAYS	450	2016	2016	512173
EXC-F	450	2000	2001	512144
EXC-F	450	2002	2002	512144
EXC-F	450	2003	2003	512144
EXC-F	450	2003	2003	512146
EXC-F	450	2004	2004	512146
EXC-F	450	2005	2006	512146

ATHENA				
Modèle	Cylindre	Année début	Année fin	Réf.
EXC-F	450	2007	2007	512146
EXC-F	450	2008	2008	512146
EXC-F	450	2009	2009	512146
EXC-F	450	2010	2011	512146
EXC-F	450	2005	2006	512172
EXC-F	450	2007	2007	512172
EXC-F	450	2008	2008	512172
EXC-F	450	2009	2009	512172
EXC-F	450	2010	2011	512172
EXC-F	450	2012	2012	512172
EXC-F	450	2013	2013	512172
EXC-F	450	2014	2014	512172
EXC-F	450	2015	2015	512172
EXC-F	450	2016	2016	512172
EXC-F	450	2017	2017	512172
EXC-F	450	2018	2018	512172
EXC-F	450	2019	2019	512172
EXC-F	450	2020	2020	512172
EXC-F	450	2013	2013	512173
EXC-F	450	2014	2014	512173
EXC-F	450	2015	2015	512173
EXC-F	450	2016	2016	512173
EXC-F	450	2017	2017	512173
EXC-F	450	2018	2018	512173
EXC-F	450	2019	2019	512173
EXC-F	450	2020	2020	512173
SMR	450	2005	2006	512172
SMR	450	2007	2007	512172
SMR	450	2008	2008	512172
SMR	450	2009	2010	512172
SMR	450	2011	2011	512172
SMR	450	2012	2012	512172
SMR	450	2013	2013	512172
SMR	450	2014	2014	512172
SMR	450	2005	2006	512173
SMR	450	2007	2007	512173
SMR	450	2008	2008	512173
SMR	450	2009	2010	512173
SMR	450	2011	2011	512173
SMR	450	2012	2012	512173
SMR	450	2013	2013	512173
SMR	450	2014	2014	512173
SX RACING	450	2002	2002	512144
SX RACING	450	2003	2003	512144
SX RACING	450	2004	2004	512144

ATHENA				
Modèle	Cylindre	Année début	Année fin	Réf.
SX	450	2000	2000	512144
SX	450	2001	2001	512144
SX	450	2002	2002	512144
SX	450	2003	2003	512144
SX RACING	450	2002	2002	512146
SX RACING	450	2003	2003	512146
SX RACING	450	2004	2004	512146
SX	450	2000	2000	512146
SX	450	2001	2001	512146
SX	450	2002	2002	512146
SX	450	2003	2003	512146
SX RACING	450	2005	2005	512172
SX RACING	450	2006	2006	512172
SX RACING	450	2007	2007	512172
SX	450	2005	2005	512172
SX	450	2006	2006	512172
SX	450	2007	2007	512172
SX RACING	450	2005	2005	512173
SX RACING	450	2006	2006	512173
SX RACING	450	2007	2007	512173
SX	450	2005	2005	512173
SX	450	2006	2006	512173
SX	450	2007	2007	512173
SX-F	450	2007	2007	512172
SX-F	450	2008	2008	512172
SX-F	450	2009	2009	512172
SX-F	450	2010	2010	512172
SX-F	450	2011	2011	512172
SX-F	450	2012	2012	512172
SX-F	450	2013	2013	512172
SX-F	450	2014	2015	512172
SX-F	450	2016	2016	512172
SX-F	450	2017	2017	512172
SX-F	450	2018	2018	512172
SX-F	450	2019	2019	512172
SX-F	450	2020	2020	512172
SX-F	450	2007	2007	512173
SX-F	450	2008	2008	512173
SX-F	450	2009	2009	512173
SX-F	450	2010	2010	512173
SX-F	450	2011	2011	512173
SX-F	450	2012	2012	512173
SX-F	450	2013	2013	512173
SX-F	450	2014	2015	512173
SX-F	450	2016	2016	512173

ATHENA				
Modèle	Cylindre	Année début	Année fin	Réf.
SX-F	450	2017	2017	512173
SX-F	450	2018	2018	512173
SX-F	450	2019	2019	512173
SX-F	450	2020	2020	512173
XC-F	450	2008	2008	512146
XC-F	450	2009	2009	512146
XC-F	450	2008	2008	512172
XC-F	450	2009	2009	512172
XC-F	450	2010	2010	512172
XC-F	450	2011	2011	512172
XC-F	450	2012	2012	512172
XC-F	450	2013	2013	512172
XC-F	450	2014	2015	512172
XC-F	450	2016	2016	512172
XC-F	450	2018	2018	512172
XC-F	450	2019	2019	512172
XC-F	450	2020	2020	512172
XC-F	450	2013	2013	512173
XC-F	450	2014	2015	512173
XC-F	450	2016	2016	512173
XC-F	450	2018	2018	512173
XC-F	450	2019	2019	512173
XC-F	450	2020	2020	512173
XC-W	450	2010	2010	512146
XC-W	450	2011	2011	512146
XC-W	450	2010	2010	512172
XC-W	450	2011	2011	512172
XC-W	450	2012	2012	512172
XC-W	450	2013	2013	512172
XC-W	450	2012	2012	512173
XC-W	450	2013	2013	512173
MX	495	1983	1983	512036
MX	495	1984	1984	512036
CROSS	500	1982	1982	480623
EXC F SIX DAYS	500	2012	2012	512172
EXC F SIX DAYS	500	2013	2013	512172
EXC F SIX DAYS	500	2014	2015	512172
EXC	500	2012	2013	512172
EXC	500	2014	2015	512172
EXC	500	2016	2016	512172
EXC F SIX DAYS	500	2012	2012	512173
EXC F SIX DAYS	500	2013	2013	512173
EXC F SIX DAYS	500	2014	2015	512173
EXC	500	2012	2013	512173
EXC	500	2014	2015	512173

ATHENA				
Modèle	Cylindre	Année début	Année fin	Réf.
EXC	500	2016	2016	512173
EXC-F	500	2017	2017	512172
EXC-F	500	2018	2018	512172
EXC-F	500	2019	2019	512172
EXC-F	500	2020	2020	512172
EXC-F	500	2017	2017	512173
EXC-F	500	2018	2018	512173
EXC-F	500	2019	2019	512173
EXC-F	500	2020	2020	512173
GS	500	1983	1983	480623
K4	500	1985	1985	512036
MX	500	1985	1985	512036
MX	500	1986	1986	512036
MX IBS	500	1993	1993	512037
MX	500	1992	1992	512037
XC-W	500	2012	2013	512172
XC-W	500	2014	2014	512172
XC-W	500	2015	2015	512172
XC-W	500	2012	2013	512173
XC-W	500	2014	2014	512173
XC-W	500	2015	2015	512173
XC-F	505	2008	2008	512172
XC-F	505	2009	2009	512172
XC-F	505	2010	2010	512172
XC-F	505	2011	2018	512172
EXC RACING	520	1999	1999	512043
EXC RACING	520	2000	2001	512128
EXC RACING	520	2002	2002	512144
EXC RACING	520	2003	2004	512144
EXC RACING	520	2002	2002	512146
EXC RACING	520	2003	2004	512146
EXC RACING	520	2005	2007	512172
EXC RACING	520	2005	2007	512173
SX RACING	520	1999	1999	512043
SX RACING	520	2000	2000	512128
SX RACING	520	2001	2001	512128
SX RACING	520	2002	2002	512144
SX RACING	520	2003	2004	512144
SX RACING	520	2002	2002	512146
SX RACING	520	2003	2004	512146
SX RACING	520	2005	2006	512172
SX RACING	520	2007	2007	512172
SX RACING	520	2005	2006	512173
SX RACING	520	2007	2007	512173
EXC RACING	525	2002	2002	512144

ATHENA				
Modèle	Cylindre	Année début	Année fin	Réf.
EXC RACING	525	2003	2003	512144
EXC RACING	525	2004	2004	512144
EXC	525	2000	2002	512144
EXC	525	2003	2003	512144
EXC RACING	525	2002	2002	512146
EXC RACING	525	2003	2003	512146
EXC RACING	525	2004	2004	512146
EXC	525	2003	2003	512146
EXC RACING	525	2005	2005	512172
EXC RACING	525	2006	2006	512172
EXC RACING	525	2007	2007	512172
EXC RACING	525	2005	2005	512173
EXC RACING	525	2006	2006	512173
EXC RACING	525	2007	2007	512173
SX	525	2002	2002	512144
SX	525	2003	2003	512144
SX	525	2004	2004	512144
SX	525	2003	2003	512146
SX	525	2004	2004	512146
SX	525	2005	2005	512172
SX	525	2006	2006	512172
SX	525	2007	2007	512172
SX	525	2005	2005	512173
SX	525	2006	2006	512173
SX	525	2007	2007	512173
EXC	530	2007	2007	512146
EXC	530	2008	2008	512146
EXC	530	2009	2009	512146
EXC	530	2010	2010	512146
EXC	530	2011	2011	512146
EXC	530	2007	2007	512172
EXC	530	2008	2008	512172
EXC	530	2009	2009	512172
EXC	530	2010	2010	512172
EXC	530	2011	2011	512172
XC-W	530	2009	2009	512146
XC-W	530	2010	2010	512146
XC-W	530	2011	2011	512146
XC-W	530	2009	2009	512172
XC-W	530	2010	2010	512172
XC-W	530	2011	2011	512172
D-CX	550	1992	1992	512037
MXC	550	1993	1993	512037
SMR	560	2006	2006	512172
SMR	560	2007	2007	512172

ATHENA				
Modèle	Cylindre	Année début	Année fin	Réf.
SMR	560	2006	2006	512173
SMR	560	2007	2007	512173
BAJA	600	1985	1986	512036
EGS 620	600	1997	1997	512043
GS	600	1984	1984	512036
SX 620	600	1997	1997	512043
EXC 4T	612	1993	1993	512037
EXC	620	1997	1997	512043
SX	620	1994	1995	512037
SX	620	1996	1996	512043
SX	620	1997	1997	512043
SX	620	1998	1998	512043
E 4T		1994	1994	512037
SX 4T		1994	1994	512037
MAICO				
ENDURO	250	-	-	512039
MC	250	-	-	512039
ENDURO	490	-	-	512039
MC-USA	490	-	-	512039
490 E USA H2O	500	-	-	512039
MARZOCCHI				
28 MM FORK TUBES		-	-	512045
32 MM FORK TUBES		-	-	512038
35 MM FORK TUBES		-	-	493905
38 MM FORK TUBES		1979	1979	512016
38 MM FORK TUBES		1980	1980	512017
40 MM FORK TUBES		-	-	480623
42 MM FORK TUBES		-	-	512036
45 MM FORK TUBES		2004	2004	512047
MAGNUM 45 MM FORK TUBES		-	-	512040
MAGNUM 47 MM FORK TUBES		-	-	512042
MAGNUM 50 MM FORK TUBES		-	-	512044
MONTESA				
35 MM FORK TUBES		-	-	493905
PAIOLI				
28 MM FORK TUBES		-	-	512045
31,7 MM FORK TUBES		-	-	512002
48 MM FORK TUBES		-	-	512142
PENTON				
35 MM FORK TUBES		-	-	493905
38 MM FORK TUBES		-	-	512017

MOTEUR

CYCLE

PNEUMATIQUE

ATELIER

ACCESSOIRES

ÉLECTRICITÉ

FILTRATION

FREINAGE

TRANSMISSION

ATHENA				
Modèle	Cylindre	Année début	Année fin	Réf.
SHOWA				
43 MM FORK TUBES UPSIDE DOWN		-	-	512027
43 MM FORK TUBES		-	-	512028
43 MM FORK TUBES UPSIDE DOWN		-	-	512052
43 MM FORK TUBES		-	-	512120
45 MM FORK TUBES		-	-	512031
45 MM FORK TUBES		-	-	512050
46 MM FORK TUBES		-	-	512048
49 MM FORK TUBES UPSIDE DOWN		-	-	512041
SUZUKI				
DR Z	125	2003	2010	493904
DR Z	125	2011	2012	493904
RM	125	1975	1976	493902
RM	125	1977	1977	512010
RM	125	1978	1978	512010
RM	125	1979	1979	512017
RM	125	1980	1980	512017
RM	125	1981	1981	512017
RM	125	1982	1983	512017
RM	125	1990	1990	512024
RM	125	1988	1988	512029
RM	125	1984	1984	512030
RM	125	1985	1985	512030
RM	125	1986	1986	512030
RM	125	1987	1987	512030
RM	125	1991	1991	512031
RM	125	1992	1992	512031
RM	125	1993	1993	512031
RM	125	1994	1994	512031
RM	125	1995	1995	512031
RM	125	1996	1996	512041
RM	125	1997	1997	512041
RM	125	1998	1998	512041
RM	125	1999	1999	512041
RM	125	2000	2000	512041
RM	125	2001	2001	512042
RM	125	2002	2002	512042
RM	125	2003	2003	512042
RM	125	2004	2004	512042
RM	125	2005	2005	512042
RM	125	2006	2007	512042
RM	125	2008	2008	512042
RM	125	1991	1991	512050

ATHENA				
Modèle	Cylindre	Année début	Année fin	Réf.
RM	125	1992	1992	512050
RM	125	1993	1993	512050
RM	125	1994	1994	512050
RM	125	1995	1995	512050
RM	125	1988	1988	486028
RM	125	1977	1977	512051
RM	125	1978	1978	512051
RM	125	2001	2001	512123
RM	125	2002	2002	512123
RM	125	2003	2003	512123
RM	125	2004	2004	512123
RM	125	2005	2005	512123
RM	125	2006	2007	512123
RM	125	2008	2008	512123
RM	125	1996	1996	512124
RM	125	1997	1997	512124
RM	125	1998	1998	512124
RM	125	1999	1999	512124
RM	125	2000	2000	512124
RM	125	1989	1989	512130
RM	250	1976	1976	480603
RM	250	1977	1977	480603
RM	250	1978	1978	480603
RM	250	1979	1980	512017
RM	250	1981	1981	512017
RM	250	1982	1982	512017
RM	250	1989	1989	512024
RM	250	1990	1990	512024
RM	250	1988	1988	512029
RM	250	1983	1984	512030
RM	250	1985	1985	512030
RM	250	1986	1986	512030
RM	250	1987	1987	512030
RM	250	1991	1992	512031
RM	250	1993	1993	512031
RM	250	1994	1994	512031
RM	250	1995	1995	512031
RM	250	1996	1997	512041
RM	250	1998	1998	512041
RM	250	1999	1999	512041
RM	250	2000	2000	512041
RM	250	2005	2005	512042
RM	250	2006	2007	512042
RM	250	2008	2008	512042
RM	250	2001	2001	512048

ATHENA				
Modèle	Cylindre	Année début	Année fin	Réf.
RM	250	2002	2002	512048
RM	250	2003	2003	512048
RM	250	2004	2004	512048
RM	250	1991	1992	512050
RM	250	1993	1993	512050
RM	250	1994	1994	512050
RM	250	1995	1995	512050
RM	250	1988	1988	486028
RM	250	1996	1997	512124
RM	250	1998	1998	512124
RM	250	1999	1999	512124
RM	250	2000	2000	512124
RM	250	2001	2001	512126
RM	250	2002	2002	512139
RM	250	2003	2003	512139
RM	250	2004	2004	512139
RM	250	2005	2005	512139
RM	250	2006	2007	512139
RM	250	2008	2008	512139
RMX	250	1989	1989	512024
RMX	250	1990	1990	512024
RMX	250	1991	1992	512031
RMX	250	1993	1994	512031
RMX	250	1995	1995	512031
RMX	250	1996	1996	512031
RMX	250	1997	1998	512031
RMX	250	1991	1992	512050
RMX	250	1993	1994	512050
RMX	250	1995	1995	512050
RMX	250	1996	1996	512050
RMX	250	1997	1998	512050
RM-Z	250	2007	2007	512042
RM-Z	250	2008	2009	512042
RM-Z	250	2010	2010	512042
RM-Z	250	2011	2011	512042
RM-Z	250	2012	2012	512042
RM-Z	250	2007	2007	512123
RM-Z	250	2008	2009	512123
RM-Z	250	2010	2010	512123
RM-Z	250	2011	2011	512123
RM-Z	250	2012	2012	512123
RM-Z	250	2004	2004	512141
RM-Z	250	2005	2006	512141
RM-Z	250	2004	2004	512149
RM-Z	250	2005	2006	512149

ATHENA				
Modèle	Cylindre	Année début	Année fin	Réf.
RM-Z	250	2016	2016	512149
RM-Z	250	2017	2017	512149
RM-Z	250	2018	2018	512149
RM-Z	250	2019	2019	512149
RM-Z	250	2013	2013	512209
RM-Z	250	2014	2014	512209
RM-Z	250	2015	2015	512209
RM-Z	250	2016	2016	512209
RM-Z	250	2017	2017	512209
RM-Z	250	2018	2018	512209
RM-Z	250	2019	2019	512209
RM	370	1976	1977	512010
RM	370	1976	1977	512051
DR-Z E	400	2005	2006	512041
DR-Z E	400	2007	2007	512041
DR-Z	400	2000	2004	512041
DR-Z	400	2005	2006	512041
DR-Z	400	2007	2007	512041
RM	400	1978	1978	512010
RM	400	1979	1980	512017
RM	400	1978	1978	512051
RMX-Z	450	2014	2014	512048
RMX-Z	450	2015	2016	512048
RMX-Z	450	2014	2014	512139
RMX-Z	450	2015	2016	512139
RMX-Z	450	2017	2017	512139
RM-Z	450	2015	2015	512041
RM-Z	450	2016	2016	512041
RM-Z	450	2017	2017	512041
RM-Z	450	2018	2018	512041
RM-Z	450	2019	2019	512041
RM-Z	450	2020	2020	512041
RM-Z	450	2005	2005	512042
RM-Z	450	2006	2006	512042
RM-Z	450	2007	2007	512042
RM-Z	450	2008	2009	512042
RM-Z	450	2012	2012	512042
RM-Z	450	2005	2005	512123
RM-Z	450	2006	2006	512123
RM-Z	450	2007	2007	512123
RM-Z	450	2008	2009	512123
RM-Z	450	2012	2012	512123
RM-Z	450	2013	2013	512209
RM-Z	450	2014	2014	512209
RM	465	1981	1982	512030

MOTEUR

CYCLE

PNEUMATIQUE

ATELIER

ACCESSOIRES

ÉLECTRICITÉ

FILTRATION

FREINAGE

TRANSMISSION

ATHENA				
Modèle	Cylindre	Année début	Année fin	Réf.
RM	500	1982	1982	512030
RM	500	1983	1984	512030
VOR				
EN	400	2000	2001	512135
EN	400	2002	2002	512135
EN	450	2004	2004	512135
EN	450	2003	2003	512142
MX	450	2002	2003	512142
SM E	450	2002	2004	512135
SM	450	2002	2002	512135
SM	450	2003	2003	512135
500 492 ENDURO	500	1999	1999	512044
500 492 SUPERMOTARD	500	1999	1999	512044
500 492 ENDURO	500	2000	2001	512135
EN 503	500	2000	2001	512135
MX 495	500	1999	1999	512135
MX 503	500	2000	2001	512135
SM 503	500	2000	2001	512044
SM 503 E	500	2002	2002	512135
EN	530	2004	2004	512135
EN	530	2003	2003	512142
MX	530	2002	2003	512142
SM E	530	2002	2004	512135
SM	530	2001	2001	512135
SM	530	2002	2002	512135
SM	530	2003	2003	512135
WHITE POWER				
40 MM FORK TUBES		-	-	512037
43 MM FORK TUBES		-	-	512145
48 MM FORK TUBES		-	-	512146
50 MM FORK TUBES		-	-	512043
YAMAHA				
YZ	125	1974	1974	480600
YZ	125	1975	1975	480600
YZ	125	1976	1976	512007
YZ	125	1977	1978	480603
YZ	125	1979	1979	480603
YZ	125	1980	1980	480603
YZ	125	1981	1981	512016
YZ	125	1982	1982	512016
YZ	125	1983	1983	512016
YZ	125	1989	1989	512024
YZ	125	1990	1990	512024
YZ	125	1984	1985	512028
YZ	125	1991	1991	512029

ATHENA				
Modèle	Cylindre	Année début	Année fin	Réf.
YZ	125	1992	1992	512029
YZ	125	1993	1993	512029
YZ	125	1994	1994	512029
YZ	125	1995	1995	512029
YZ	125	1996	1996	512048
YZ	125	1997	1997	512048
YZ	125	1998	1998	512048
YZ	125	1999	1999	512048
YZ	125	2000	2000	512048
YZ	125	2001	2001	512048
YZ	125	2002	2002	512048
YZ	125	2003	2003	512048
YZ	125	1984	1985	512120
YZ	125	1991	1991	512125
YZ	125	1992	1992	512125
YZ	125	1993	1993	512125
YZ	125	1994	1994	512125
YZ	125	1995	1995	512125
YZ	125	1996	1996	512126
YZ	125	1997	1997	512126
YZ	125	1998	1998	512126
YZ	125	1999	1999	512126
YZ	125	2000	2000	512126
YZ	125	2001	2001	512126
YZ	125	2002	2002	512126
YZ	125	2003	2003	512126
YZ	125	2004	2004	512141
YZ	125	2015	2015	512146
YZ	125	2016	2016	512146
YZ	125	2017	2017	512146
YZ	125	2018	2018	512146
YZ	125	2019	2019	512146
YZ	125	2020	2020	512146
YZ	125	2004	2004	512149
YZ	125	2005	2005	512149
YZ	125	2006	2007	512149
YZ	125	2008	2011	512149
YZ	125	2012	2014	512149
YZ	125	2015	2015	512149
YZ	125	2016	2016	512149
YZ	125	2017	2017	512149
YZ	125	2018	2018	512149
YZ	125	2019	2019	512149
YZ	125	2020	2020	512149
YZ	125	2005	2005	512171

ATHENA				
Modèle	Cylindre	Année début	Année fin	Réf.
YZ	125	2006	2007	512171
YZ	125	2008	2011	512171
YZ	125	2012	2014	512171
IT	200	1984	1986	512030
WR	200	1992	1992	512024
WR	250	1991	1991	512029
WR	250	1992	1994	512029
WR	250	1995	1996	512029
WR	250	1997	1997	512029
WR F	250	2001	2002	512048
WR F	250	2003	2003	512048
WR F	250	2004	2004	512048
WR R	250	2008	2012	512048
WR R	250	2013	2013	512048
WR X	250	2008	2008	512048
WR X	250	2009	2010	512048
WR X	250	2011	2011	512048
WR X	250	2012	2012	512048
WR X	250	2013	2013	512048
WR	250	1997	1997	512048
WR	250	1998	1998	512048
WR	250	1991	1991	486028
WR	250	1992	1994	486028
WR	250	1995	1996	486028
WR	250	1997	1997	486028
WR F	250	2001	2002	512126
WR F	250	2003	2003	512126
WR F	250	2004	2004	512126
WR R	250	2008	2012	512126
WR R	250	2013	2013	512126
WR X	250	2008	2008	512126
WR X	250	2009	2010	512126
WR X	250	2011	2011	512126
WR X	250	2012	2012	512126
WR X	250	2013	2013	512126
WR	250	1997	1997	512126
WR	250	1988	1988	512127
WR	250	1989	1989	512127
WR	250	1990	1990	512127
WR	250	1991	1991	512127
WR	250	1992	1994	512127
WR	250	1995	1996	512127
WR F	250	2015	2016	512146
WR F	250	2017	2017	512146
WR F	250	2018	2018	512146

ATHENA				
Modèle	Cylindre	Année début	Année fin	Réf.
WR F	250	2005	2005	512149
WR F	250	2006	2006	512149
WR F	250	2007	2007	512149
WR F	250	2008	2010	512149
WR F	250	2011	2011	512149
WR F	250	2012	2012	512149
WR F	250	2013	2013	512149
WR F	250	2015	2016	512149
WR F	250	2017	2017	512149
WR F	250	2018	2018	512149
WR F	250	2005	2005	512171
WR F	250	2006	2006	512171
WR F	250	2007	2007	512171
WR F	250	2008	2010	512171
WR F	250	2011	2011	512171
WR F	250	2012	2012	512171
WR F	250	2013	2013	512171
YZ 2T	250	1974	1975	512007
YZ 2T	250	1977	1977	512016
YZ 2T	250	1978	1980	512016
YZ 2T	250	1989	1989	512024
YZ 2T	250	1990	1990	512024
YZ 2T	250	1981	1981	512030
YZ 2T	250	1982	1982	512030
YZ 2T	250	1983	1983	512030
YZ 2T	250	1984	1985	512030
YZ 2T	250	1986	1986	512030
YZ 2T	250	1987	1987	512030
YZ 2T	250	1988	1988	512030
YZ 2T	250	1995	1995	512030
YZ 2T	250	1996	1996	512048
YZ 2T	250	1997	1997	512048
YZ 2T	250	1998	1998	512048
YZ 2T	250	1999	1999	512048
YZ 2T	250	2000	2000	512048
YZ 2T	250	2001	2002	512048
YZ 2T	250	2003	2003	512048
YZ F	250	2001	2002	512048
YZ F	250	2003	2003	512048
YZ 2T	250	1996	1996	512126
YZ 2T	250	1997	1997	512126
YZ 2T	250	1998	1998	512126
YZ 2T	250	1999	1999	512126
YZ 2T	250	2000	2000	512126
YZ 2T	250	2001	2002	512126

MOTEUR

CYCLE

PNEUMATIQUE

ATELIER

ACCESSOIRES

ÉLECTRICITÉ

FILTRATION

FREINAGE

TRANSMISSION

ATHENA				
Modèle	Cylindre	Année début	Année fin	Réf.
YZ 2T	250	2003	2003	512126
YZ F	250	2001	2002	512126
YZ F	250	2003	2003	512126
YZ 2T	250	1994	1994	512127
YZ 2T	250	1995	1995	512127
YZ 2T	250	2004	2004	512141
YZ F	250	2004	2004	512141
YZ 2T	250	2015	2015	512146
YZ 2T	250	2016	2016	512146
YZ 2T	250	2017	2018	512146
YZ 2T	250	2019	2019	512146
YZ 2T	250	2020	2020	512146
YZ F	250	2005	2005	512146
YZ F	250	2006	2006	512146
YZ F	250	2007	2007	512146
YZ F	250	2008	2008	512146
YZ F	250	2009	2009	512146
YZ F	250	2010	2012	512146
YZ F	250	2013	2013	512146
YZ F	250	2014	2014	512146
YZ F	250	2015	2015	512146
YZ F	250	2016	2016	512146
YZ F	250	2017	2017	512146
YZ F	250	2018	2018	512146
YZ FX	250	2015	2016	512146
YZ X	250	2016	2017	512146
YZ X	250	2018	2018	512146
YZ X	250	2019	2019	512146
YZ X	250	2020	2020	512146
YZ 2T	250	2004	2004	512149
YZ 2T	250	2005	2005	512149
YZ 2T	250	2006	2007	512149
YZ 2T	250	2008	2011	512149
YZ 2T	250	2012	2014	512149
YZ 2T	250	2015	2015	512149
YZ 2T	250	2016	2016	512149
YZ 2T	250	2017	2018	512149
YZ 2T	250	2019	2019	512149
YZ 2T	250	2020	2020	512149
YZ F	250	2004	2004	512149
YZ F	250	2005	2005	512149
YZ F	250	2006	2006	512149
YZ F	250	2007	2007	512149
YZ F	250	2008	2008	512149
YZ F	250	2009	2009	512149

ATHENA				
Modèle	Cylindre	Année début	Année fin	Réf.
YZ F	250	2010	2012	512149
YZ F	250	2013	2013	512149
YZ F	250	2014	2014	512149
YZ F	250	2015	2015	512149
YZ F	250	2016	2016	512149
YZ F	250	2017	2017	512149
YZ F	250	2018	2018	512149
YZ F	250	2019	2019	512149
YZ F	250	2020	2020	512149
YZ FX	250	2015	2016	512149
YZ FX	250	2017	2017	512149
YZ FX	250	2018	2019	512149
YZ X	250	2016	2017	512149
YZ X	250	2018	2018	512149
YZ X	250	2019	2019	512149
YZ X	250	2020	2020	512149
YZ 2T	250	2005	2005	512171
YZ 2T	250	2006	2007	512171
YZ 2T	250	2008	2011	512171
YZ 2T	250	2012	2014	512171
YZ F	250	2019	2019	512209
YZ F	250	2020	2020	512209
YZ	360	1974	1975	512007
WR F	400	1998	1998	512048
WR F	400	1999	1999	512048
WR F	400	2000	2000	512048
WR F	400	2001	2001	512048
WR F	400	2002	2002	512048
WR F	400	1998	1998	512126
WR F	400	1999	1999	512126
WR F	400	2000	2000	512126
WR F	400	2001	2001	512126
WR F	400	2002	2002	512126
YZ F	400	1977	1977	512016
YZ F	400	1978	1978	512016
YZ F	400	1979	1979	512016
YZ F	400	1998	1998	512048
YZ F	400	1999	1999	512048
WR F	426	2001	2001	512048
YZ F	426	2000	2000	512048
YZ F	426	2001	2001	512048
YZ F	426	2002	2002	512048
YZ F	426	2000	2000	512126
YZ F	426	2001	2001	512126
YZ F	426	2002	2002	512126

ATHENA				
Modèle	Cylindre	Année début	Année fin	Réf.
WR F	450	2003	2003	512048
WR F	450	2004	2004	512048
WR F	450	2003	2003	512126
WR F	450	2004	2004	512126
WR F	450	2012	2012	512146
WR F	450	2013	2013	512146
WR F	450	2014	2014	512146
WR F	450	2015	2015	512146
WR F	450	2016	2016	512146
WR F	450	2005	2005	512149
WR F	450	2006	2006	512149
WR F	450	2007	2009	512149
WR F	450	2010	2010	512149
WR F	450	2011	2011	512149
WR F	450	2012	2012	512149
WR F	450	2013	2013	512149
WR F	450	2014	2014	512149
WR F	450	2015	2015	512149
WR F	450	2016	2016	512149
WR F	450	2017	2018	512149
WR F	450	2005	2005	512171
WR F	450	2006	2006	512171
WR F	450	2007	2009	512171
WR F	450	2010	2010	512171
WR F	450	2011	2011	512171
YZ F	450	2003	2003	512048
YZ F	450	2003	2003	512126
YZ F	450	2004	2004	512141
YZ F	450	2010	2010	512146
YZ F	450	2011	2011	512146
YZ F	450	2012	2012	512146
YZ F	450	2013	2013	512146
YZ F	450	2014	2014	512146
YZ F	450	2015	2015	512146
YZ F	450	2016	2016	512146
YZ F	450	2017	2017	512146
YZ FX	450	2016	2016	512146
YZ F	450	2004	2004	512149
YZ F	450	2005	2005	512149
YZ F	450	2006	2006	512149
YZ F	450	2007	2007	512149
YZ F	450	2008	2008	512149
YZ F	450	2009	2009	512149
YZ F	450	2010	2010	512149
YZ F	450	2011	2011	512149

ATHENA				
Modèle	Cylindre	Année début	Année fin	Réf.
YZ F	450	2012	2012	512149
YZ F	450	2013	2013	512149
YZ F	450	2014	2014	512149
YZ F	450	2015	2015	512149
YZ F	450	2016	2016	512149
YZ F	450	2017	2017	512149
YZ F	450	2018	2018	512149
YZ F	450	2019	2019	512149
YZ F	450	2020	2020	512149
YZ FX	450	2016	2016	512149
YZ FX	450	2017	2017	512149
YZ FX	450	2018	2018	512149
YZ FX	450	2019	2019	512149
YZ FX	450	2020	2020	512149
YZ F	450	2005	2005	512171
YZ F	450	2006	2006	512171
YZ F	450	2007	2007	512171
YZ F	450	2008	2008	512171
YZ F	450	2009	2009	512171
YZ F	450	2018	2018	512209
YZ F	450	2019	2019	512209
YZ F	450	2020	2020	512209
YZ	465	1980	1980	512016
YZ	465	1981	1981	512030
YZ	490	1982	1983	512030
YZ	490	1984	1984	512030
YZ	490	1985	1986	512030
YZ	490	1987	1989	512030
YZ	490	1990	1990	512030
WR	500	1992	1992	512029
WR	500	1993	1993	512029
WR	500	1992	1992	486028
WR	500	1993	1993	486028

/JOINT MOTO ANCIENNE

ATHENA				
Modèle	Cylindre	Année début	Année fin	Réf.
APRILIA				
ST RADA	125	1983	1983	512038
STX	125	1984	1984	512002
MX	250	1983	1983	480623
MX	250	1985	1985	512036
BENELLI				
ENDURO	125	1984	1984	512038
354 SPORT	354	1978	1978	512038
354 SPORT II	354	1978	1983	512038
354 T	354	1978	1978	512038
500 QUATTRO	500	1976	1976	493905
500 LS	500	1978	1978	512038
504	504	1978	1978	493905
654 SPORT	654	1978	1982	493905
654 SPORT	654	1983	1983	493905
654 SPORT	654	1984	1984	493905
654 SPORT	654	1985	1985	493905
654 SPORT	654	1986	1987	493905
654 T	654	1978	1978	493905
654	654	1982	1987	493905
750 SEI	750	1976	1976	493905
4T 6 CIL	900	1976	1977	493905
4T 6 CIL	900	1978	1980	493905
4T 6 CIL	900	1981	1983	493905
4T 6 CIL	900	1984	1987	493905
BETA				
RX	125	1985	1986	493905
RX	250	1985	1986	493905
BETOR / BULTACO				
32 MM FORK TUBES		-	-	512038
35 MM FORK TUBES		-	-	493905
38 MM FORK TUBES		-	-	512017
BMW				
R80	800	1984	1987	512206
BULTACO				
32 MM FORK TUBES		-	-	512038
35 MM FORK TUBES		-	-	493905
38 MM FORK TUBES		-	-	512017
CAGIVA				
ALETTA ORO SI	125	1985	1985	493905
ALETTA ORO SI	125	1986	1986	493905
ALETTA ROSSA WSX	125	1983	1983	493905
ALETTA ROSSA WSX	125	1984	1987	493905

ATHENA				
Modèle	Cylindre	Année début	Année fin	Réf.
ELECTRA	125	1984	1984	512002
LOW RIDER	125	1984	1986	512002
RX	125	1981	1981	493905
SST	125	1983	1987	512038
SXT	125	1982	1982	493905
SXT	125	1983	1984	493905
WMX	125	1981	1982	512017
WMX	125	1983	1983	480623
WMX	125	1984	1984	480623
WMX	125	1985	1985	512036
WMX	125	1986	1986	512036
WRX	125	1982	1982	512017
WSXT	200	-	-	493905
ALA BLU SX	250	1982	1982	493905
ALA BLU SX	250	1983	1984	493905
MXR	250	1981	1981	512017
RX	250	1981	1981	493905
SST	250	1982	1982	493905
SST	250	1983	1984	493905
WMX	250	1984	1984	480623
ALA BLU SX	350	1982	1983	493905
ALA BLU SX	350	1984	1984	493905
ALA ROSSA	350	1983	1985	512017
ALA ROSSA	350	1986	1988	512017
ALA ROSSA	350	-	-	512035
ALAZURRA GT	350	1983	1984	493905
ALAZURRA GT	350	1985	1985	493905
ALAZURRA GT	350	1986	1988	493905
ELEFANT	350	1985	1985	512036
ELEFANT	350	1986	1986	512036
ELEFANT	350	1987	1987	512036
ELEFANT	350	1988	1988	512036
SST	350	1983	1983	493905
SST	350	1984	1984	493905
SX	350	1982	1982	493905
WMX	500	1985	1985	512036
WMX	500	1986	1986	512036
ALAZURRA	650	1984	1984	493905
ALAZURRA	650	1985	1985	493905
ALAZURRA	650	1986	1988	493905
ELEFANT	650	1984	1985	512036
ELEFANT	650	1986	1986	512036
ELEFANT	650	1987	1987	512036
CAN-AM				
35 MM FORK TUBES		-	-	493905



ATHENA				
Modèle	Cylindre	Année début	Année fin	Réf.
38 MM FORK TUBES		-	-	512017
42 MM FORK TUBES		-	-	512036
CERIANI				
32 MM FORK TUBES		-	-	512038
35 MM FORK TUBES		-	-	493905
38 MM FORK TUBES		-	-	512017
DUCATI				
F3 INDIANA / PANTAH	350	1986	1986	480623
F3 INDIANA / PANTAH	350	1987	1987	480623
F3 INDIANA / PANTAH	350	1988	1988	480623
F3 INDIANA / PANTAH	350	1989	1989	480623
F3 INDIANA / PANTAH	350	1986	1986	512034
F3 INDIANA / PANTAH	350	1987	1987	512034
F3 INDIANA / PANTAH	350	1988	1988	512034
GTL A.E. / GTV	350	1975	1975	493905
S	350	1975	1975	493905
SPORT GTV	350	1975	1975	493905
GTL SPORT DESMO	500	1975	1975	493905
GTV	500	1977	1977	493905
PANTAH SL / TL	500	1977	1977	493905
PANTAH SL / TL	500	1978	1984	493905
S	500	1975	1975	493905
PANTAH TL / SL	600	1980	1980	493905
PANTAH TL / SL	600	1981	1985	493905
SUPERSPORT	750	1999	1999	512028
SUPERSPORT	750	1991	1991	512049
SUPERSPORT	750	1992	1995	512049
SUPERSPORT	750	1996	1997	512049
SUPERSPORT	750	1999	1999	512120
MIKE HAILDWOOD REPLICA	900	1976	1984	512017
S2 DESMO	900	1976	1976	512017
S2 DESMO	900	1983	1984	512017
S2 DESMO	900	1985	1985	512017
FANTIC				
CABALLERO MIK	125	1986	1986	512002
CROSS	125	-	-	512002
CROSS	125	1980	1980	493905
ENDURO	125	1980	1980	493905
RAIDER ARIA	125	-	-	512034
RAIDER LC	125	-	-	512034
REGOLARITA	125	-	-	512034
RSX	125	-	-	512034
SPORT MKII	125	-	-	512002
SPORT	125	1984	1984	512034

ATHENA				
Modèle	Cylindre	Année début	Année fin	Réf.
STRADA	125	-	-	512002
TRIAL I	125	-	-	512002
TRIAL SEVEN DAYS	125	-	-	512002
RAIDER	250	1984	1984	493905
RAIDER	250	1985	1985	493905
GILERA				
CUSTOM	125	1983	1984	512038
ELECTR	125	1983	1985	493905
GRI	125	1981	1982	512038
GRI	125	1983	1984	512038
TG1	125	1981	1982	512038
TG2	125	1983	1984	512038
TG3	125	1983	1984	512038
TRIAL	125	1983	1984	493905
MX LC	250	1985	1985	512036
HONDA				
CB	125	1973	1975	511998
CB	125	1978	1981	486026
CB	125	1982	1990	486026
CB K / J / S	125	1972	1985	512046
CG	125	1978	1993	512046
CG	125	1994	1995	512046
CT C	125	1977	1985	512001
MR	125	1974	1976	512001
MT	125	1974	1976	512001
MTX	125	1983	1991	493902
MTX	125	1992	1992	493902
MTX	125	1993	1994	493902
SL	125	1971	1975	512001
SL	125	1976	1980	512001
TL	125	1973	1975	512001
TL	125	1976	1976	512001
XL S	125	1981	1984	486026
XL S	125	1985	1985	486026
XL	125	1974	1975	512001
XL	125	1976	1978	512001
XL	125	1979	1980	512001
XL	125	2001	2010	493902
CB CL K7	175	1973	1976	486026
CD	175	1971	1978	512000
MR ELSINORE	175	1975	1975	512001
MR ELSINORE	175	1976	1977	512001
SL	175	1970	1970	486026
SL	175	1971	1972	486026
XL	175	1973	1975	512001

JOINT SPI MOTO ANCIENNE / OLD MOTOORCYCLE FORK OIL SEAL

CGN
LE SENS DU DÉTAIL

MOTEUR

CYCLE

PNEUMATIQUE

ATELIER

ACCESSOIRES

ÉLECTRICITÉ

FILTRATION

FREINAGE

TRANSMISSION

ATHENA				
Modèle	Cylindre	Année début	Année fin	Réf.
XL	175	1976	1978	512001
CD	185	1978	1979	512000
CD	185	1980	1982	512000
CM T	185	1978	1979	486026
XL S / SZ / SA / SB	185	1980	1981	486026
XL S / SZ / SA / SB	185	1979	1979	512001
XR	185	1979	1979	486026
CB B / T	200	1974	1979	486026
CD TA / TB / TE	200	1979	1979	512000
CD TA / TB / TE	200	1980	1984	512000
CL SCRAMBLER	200	1974	1974	486026
CM T TWIN STAR	200	1980	1982	486026
CM T TWIN STAR	200	1983	1985	486026
MTX R	200	1983	1984	493902
MTX R	200	1985	1985	493902
TLR	200	1986	1987	512006
TR	200	1986	1987	486026
XL	200	1983	1984	512006
XR	200	1980	1980	486026
XR	200	1981	1983	486026
XR	200	1984	1984	486026
CD	250	1988	1988	486026
CD	250	1989	1992	486026
CJ	250	1977	1978	512006
CJ	250	1979	1979	512006
CL	250	1982	1982	480602
CL	250	1983	1984	480602
CM CUSTOM	250	1982	1983	486026
CM CUSTOM	250	1981	1981	480602
CM CUSTOM	250	1982	1983	480602
MR	250	1976	1976	493902
MT	250	1974	1975	493902
MT	250	1976	1976	493902
XL K	250	1978	1979	512008
XL S	250	1978	1980	493902
XL S	250	1981	1983	493902
XL S	250	1984	1987	493902
XL	250	1972	1976	493902
CB FOUR	350	1972	1972	512006
CB FOUR	350	1973	1974	512006
CB FOUR	350	1975	1975	512006
CL	350	1973	1974	512006
SL 2 CYL	350	1970	1970	512006
SL 2 CYL	350	1971	1971	512006
SL 2 CYL	350	1972	1972	493902

ATHENA				
Modèle	Cylindre	Année début	Année fin	Réf.
XL	350	1974	1974	493902
XL	350	1975	1975	493902
XL	350	1976	1978	493902
XL	350	1984	1985	512021
XR R	350	1983	1983	512026
XR R	350	1984	1984	512026
XR R	350	1985	1985	512026
CB	360	1974	1976	512006
CJ	360	1976	1977	512006
CJ	360	1978	1978	512006
CJ	360	1979	1979	512006
CL	360	1974	1974	512006
CL	360	1975	1975	512006
CB FOUR SUPERSPORT	400	1975	1975	512006
CB FOUR SUPERSPORT	400	1976	1977	512006
CB FOUR SUPERSPORT	400	1978	1980	512006
CMA / C / E / T	400	1979	1981	512006
CMA / C / E / T	400	1982	1982	512006
CB K3 / K9	450	1970	1971	493902
CB K3 / K9	450	1972	1976	493902
CB	450	1968	1970	512134
CL K3-K7	450	1972	1972	493902
CL K3-K7	450	1973	1973	493902
CL K3-K7	450	1974	1974	493902
CL K3-K7	450	1969	1969	512134
CL K3-K7	450	1970	1971	512134
CL K3-K7	450	1972	1972	512134
CM CUSTOM	450	1982	1983	512006
CB FOUR	500	1971	1971	493902
CB FOUR	500	1972	1973	493902
CX	500	1978	1979	512006
CX D DELUXE	500	1979	1981	512006
CX Z / A / B / CUSTOM	500	1979	1980	512006
CX Z / A / B / CUSTOM	500	1981	1981	493902
CX Z / A / B / CUSTOM	500	1982	1982	493902
FT	500	1982	1983	512015
FT	500	1984	1984	512015
GL	500	1981	1981	493902
GL	500	1982	1982	493902
GL	500	1983	1984	493902
VF C	500	1984	1984	512015
VF C	500	1985	1985	512015
VF C	500	1986	1986	512015
VF F / F2	500	1984	1984	512015
VF F / F2	500	1985	1985	512015



ATHENA				
Modèle	Cylindre	Année début	Année fin	Réf.
VF F / F2	500	1986	1986	512015
VT	500	1983	1984	512015
XL S	500	1979	1981	493902
XR R	500	1979	1980	493902
XR R	500	1981	1981	512015
XR R	500	1982	1982	512015
XR R	500	1983	1984	512028
XR R	500	1983	1984	512120
CB	550	1978	1978	512008
CB	550	1979	1979	512008
CB	550	1980	1980	512008
CB	550	1974	1974	493902
CB	550	1975	1975	493902
CB	550	1976	1977	493902
CB	550	1978	1978	493902
CB NIGHTHAWK	550	1983	1983	512015
CB C / SC	650	1979	1979	493902
CB C / SC	650	1980	1981	493902
CB C / SC	650	1982	1982	493902
CB C / SC	650	1982	1982	512015
CB C / SC	650	1983	1985	512021
CX	650	1983	1983	512015
CX	650	1984	1986	512015
CX ED / C / T	650	1983	1983	512021
CX	650	1983	1983	512021
GL D	650	1983	1984	512015
CB SC NIGHTHAWK	700	1984	1986	512020
VF C MAGNA	700	1984	1984	512015
VF C MAGNA	700	1985	1986	512015
VF C MAGNA	700	1985	1986	512021
VF C MAGNA	700	1987	1987	512021
CB FOUR	750	1969	1969	493902
CB FOUR	750	1970	1970	493902
CB L LTD	750	1969	1970	512134
CB SSC / SCD	750	1969	1970	512134
GL	1000	1977	1977	512012
GL	1000	1978	1978	512012
GL	1000	1975	1976	512013
GL	1000	1977	1977	512013
GL	1000	1978	1978	512013
GL	1000	1979	1979	512013
VTR F FIRESTORM	1000	1997	1997	512026
VTR F FIRESTORM	1000	1998	1999	512026
VTR F FIRESTORM	1000	2000	2000	512026
VTR F FIRESTORM	1000	2001	2002	512026

ATHENA				
Modèle	Cylindre	Année début	Année fin	Réf.
VTR F FIRESTORM	1000	2003	2005	512026
VTR F FIRESTORM	1000	1998	1999	512191
VTR F FIRESTORM	1000	2000	2000	512191
VTR F FIRESTORM	1000	2001	2002	512191
VTR F FIRESTORM	1000	2003	2005	512191
CB R / F	1100	1981	1981	512015
CB R / F	1100	1982	1982	512021
CB R / F	1100	1983	1983	512021
CB R / F	1100	1984	1984	512021
HUSQVARNA				
ALL MODELS		1975	1980	493905
KAWASAKI				
KH	125	1982	1982	480600
KH	125	1983	1994	480600
KH	125	1977	1981	512046
KH	125	1982	1982	512046
KMX	125	1986	1986	493902
KMX	125	1987	1989	493902
KMX	125	1990	1993	493902
KS A	125	1974	1974	512001
KS A	125	1975	1975	512001
KMX A2 / A3 / A4	200	1988	1989	512017
KMX A2 / A3 / A4	200	1990	1990	512017
KMX A2 / A3 / A4	200	1991	1992	512017
Z	200	1981	1982	486026
Z	200	1983	1983	486026
Z	200	1977	1980	512003
F4	250	1968	1970	512007
F8	250	1971	1972	512007
KH	250	1976	1976	512007
KH	250	1977	1980	512007
KH	250	1981	1982	512007
KT	250	1975	1976	512007
KXT	250	1984	1984	480603
KXT	250	1985	1985	480603
KXT	250	1986	1986	512025
KXT	250	1987	1987	512025
KZ L / W / B	250	1982	1982	486026
KZ L / W / B	250	1983	1983	486026
KZ D1 / D2 / L1 / LTD SELT DRIVE	250	1980	1980	512001
SI	250	1972	1975	512006
Z A1 / 3	250	1979	1982	512006
Z A1 / 3	250	1983	1983	512006
Z B1 / 2	250	1979	1982	512006

JOINT SPI MOTO ANCIENNE / OLD MOTOORCYCLE FORK OIL SEAL

CGN
LE SENS DU DÉTAIL

MOTEUR

CYCLE

PNEUMATIQUE

ATELIER

ACCESSOIRES

ÉLECTRICITÉ

FILTRATION

FREINAGE

TRANSMISSION

ATHENA				
Modèle	Cylindre	Année début	Année fin	Réf.
Z B1/ 2	250	1983	1983	512006
KZ A/ B/ BR:CSR	305	1981	1982	512006
KZ A/ B/ BR:CSR	305	1983	1986	512006
KZ A/ B/ BR:CSR	305	1987	1988	512006
F5	350	1970	1971	512007
F9	350	1972	1975	512007
S2	350	1972	1972	512006
S2	350	1973	1973	512006
KH	400	1975	1975	512007
KH	400	1976	1978	512007
KH	400	1979	1981	512007
KX A	400	1975	1975	512008
KX A	400	1976	1976	480603
KZ A/ B/ C/ D	400	1974	1979	512006
S3	400	1974	1975	512006
Z J1/ J3/ GPZ	400	1981	1981	512011
Z J1/ J3/ GPZ	400	1982	1983	512011
KX A1/ A2	420	1981	1981	512017
KX A1/ A2	420	1982	1982	512017
KZ D LTD	440	1980	1982	512006
KZ D LTD	440	1983	1983	512006
Z	440	1979	1979	512006
Z	440	1980	1980	512006
Z	440	1981	1981	512006
Z	440	1982	1982	512006
Z	440	1983	1983	512006
Z	440	1984	1984	512006
Z	440	1982	1982	480602
Z	440	1983	1983	480602
Z	440	1984	1984	480602
LTD	450	1985	1985	512006
H1 A/ C	500	1969	1971	512007
H1 A/ C	500	1973	1973	512007
H1 B/ D/ E/ F	500	1972	1975	512008
KH	500	1976	1976	480603
KH	500	1977	1977	480603
Z B1/ B2	500	1979	1980	512011
KZ F1/ F2/ H1H/ 2/ M1	550	1982	1982	493902
KZ F1/ F2/ H1H/ 2/ M1	550	1983	1983	493902
KZ F1/ F2/ H1H/ 2/ M1	550	1983	1983	512010
KZ F1/ F2/ H1H/ 2/ M1	550	1984	1984	512010
KZ	550	1980	1980	512011
KZ	550	1981	1983	512011
KZ F1/ F2/ H1H/ 2/ M1	550	1983	1983	512051
KZ F1/ F2/ H1H/ 2/ M1	550	1984	1984	512051

ATHENA				
Modèle	Cylindre	Année début	Année fin	Réf.
KZ H/ F	650	1981	1982	512010
KZ H/ F	650	1983	1983	512010
KZ B/ C/ D/ E/ F/ H/ CSR/ LTD	650	1977	1979	480603
KZ B/ C/ D/ E/ F/ H/ CSR/ LTD	650	1980	1980	480603
KZ H/ F	650	1981	1982	512051
KZ H/ F	650	1983	1983	512051
Z D1/ D1A/ D2/ D3/ D4	650	1980	1982	512010
Z D1/ D1A/ D2/ D3/ D4	650	1983	1983	512010
Z B/ C/ D/ F1	650	1976	1979	480603
Z B/ C/ D/ F1	650	1980	1980	480603
Z SR	650	1979	1980	480603
Z D1/ D1A/ D2/ D3/ D4	650	1980	1982	512051
Z D1/ D1A/ D2/ D3/ D4	650	1983	1983	512051
KZ A	700	1984	1984	512010
KZ A	700	1984	1984	512051
VN A1 VULCAN	700	1985	1985	512018
ZN	700	1984	1984	512010
ZN	700	1985	1985	512010
ZN	700	1984	1984	512051
ZN	700	1985	1985	512051
H2 MACH 4	750	1972	1975	493902
KZ E/ H/ K/ L3/ M1/ R1	750	1980	1984	512010
KZ B1/ B4K1/ K2/ G1/ M1	750	1976	1979	480603
KZ B1/ B4K1/ K2/ G1/ M1	750	1980	1980	480603
KZ F1	750	1982	1982	512011
KZ F1	750	1983	1983	512011
KZ E/ H/ K/ L3/ M1/ R1	750	1980	1984	512051
VN A1-A8 VULCAN/ DRIFTER C1-C2/DRIFTER EI-E2	800	1999	2001	512026
KZ A4/ A5/ B1	900	1976	1976	480603
KZ A4/ A5/ B1	900	1977	1977	480603
Z A	900	1976	1976	480603
Z1	900	1973	1973	493902
Z1	900	1974	1974	493902
Z1	900	1975	1975	493902
KZ A/ B/ C/ D/ E	1000	1977	1978	480603
KZ A/ B/ C/ D/ E	1000	1979	1980	480603
KZ A/ B/ C/ D/ E	1000	1981	1981	480603
KZ C2/ C4	1000	1979	1981	512017
KZ A/ B/ C/ D/ E	1000	1979	1980	512022
Z1 R	1000	1978	1978	480603
KZ GP/ GPZ/ LTD	1100	1981	1982	512016
KZ GP/ GPZ/ LTD	1100	1983	1983	512016



ATHENA				
Modèle	Cylindre	Année début	Année fin	Réf.
ZN B / B1 / BIL / B2 LTD	1100	1984	1984	512016
ZN B / B1 / BIL / B2 LTD	1100	1985	1985	512016
ZX GPZ UNITRAK	1100	1983	1983	512014
ZX GPZ UNITRAK	1100	1984	1984	512014
KZ A / B TOURING	1300	1979	1982	512024
ZG	1300	1984	1986	512024
ZN A VOYAGER	1300	1983	1984	512024
ZN A VOYAGER	1300	1985	1985	512024
ZN A VOYAGER	1300	1986	1988	512024
KTM				
ALL 35 MM FORK TUBES		1976	1978	493905
ALL 38 MM FORK TUBES		1979	1979	512016
MOTO GUZZI				
4T 2C	125	-	-	512038
250 TS	250	-	-	512038
350 4C	350	-	-	512038
V35 CARABINIERI PA	350	1992	1992	493905
V35 III CARABINIERI	350	1990	1991	493905
VI 35 IMOLA II	350	1984	1987	493905
400 4C	400	-	-	512038
LE MANS I / II / III	850	1980	1985	493905
T	850	-	-	493905
T3	850	1975	1978	493905
T3	850	1979	1980	493905
T4	850	1980	1983	493905
T5	850	1983	1984	493905
T5 POLIZIA CC-PA VECCHIO TIPO	850	1985	1989	512017
T5	850	1985	1988	512017
T5 POLIZIA CC / PA (NC	850	1988	1992	480623
T5 POLIZIA CC / PA (NC	850	1993	1993	480623
T5 POLIZIA CC / PA (NC	850	1995	1995	480623
OSSA				
35 MM FORK TUBES		-	-	493905
SUZUKI				
DS	125	1979	1981	493904
GP	125	1977	1977	512046
GP	125	1978	1978	512046
GP	125	1979	1981	512046
GP	125	1982	1983	512046
GT	125	1974	1974	480600
GT	125	1975	1977	480600
GT	125	1978	1978	480600
GT	125	1979	1979	480600
GT	125	1980	1981	480600

ATHENA				
Modèle	Cylindre	Année début	Année fin	Réf.
SP	125	1986	1988	493902
SP	125	1982	1983	480619
T	125	1969	1969	512046
TC	125	1972	1977	480600
TM	125	1973	1975	480600
TS	125	1971	1977	480600
TS	125	1978	1978	493904
TS	125	1979	1979	493904
TS	125	1979	1979	480619
TS	125	1980	1981	480619
TS	125	1982	1982	480619
PE	175	1978	1981	512010
PE	175	1982	1982	512017
PE	175	1983	1983	512017
PE	175	1984	1984	512017
PE	175	1978	1981	512051
RS	175	1980	1982	512010
RS	175	1980	1982	512051
DS	185	1978	1978	480600
DS	185	1979	1980	512004
GT	185	1973	1974	480600
GT	185	1975	1977	493904
TC L / M / A / B	185	1974	1977	480600
TS	185	1971	1975	480600
TS	185	1976	1978	480600
TS	185	1979	1980	512004
TS	185	1981	1981	512004
GT	200	1979	1979	480600
GT	200	1980	1981	480600
SB	200	1979	1981	480600
SP	200	1986	1986	493902
SP	200	1987	1988	493902
T TC	200	1969	1969	480600
DS	250	1980	1980	512010
DS	250	1980	1980	512051
GS	250	1979	1979	512006
GS	250	1980	1981	512006
GS	250	1982	1982	512006
GSX T / EX	250	1979	1979	493902
GSX T / EX	250	1980	1980	493902
GSX T / EX	250	1981	1981	493902
GSX T / EX	250	1982	1982	493902
GT N / EN / XZ (X7	250	1978	1981	512004
GT	250	1973	1975	512006
GT	250	1976	1977	512006

JOINT SPI MOTO ANCIENNE / OLD MOTOORCYCLE FORK OIL SEAL

CGN
LE SENS DU DÉTAIL

MOTEUR

CYCLE

PNEUMATIQUE

ATELIER

ACCESSOIRES

ÉLECTRICITÉ

FILTRATION

FREINAGE

TRANSMISSION

ATHENA				
Modèle	Cylindre	Année début	Année fin	Réf.
PE	250	1977	1978	512010
PE	250	1979	1979	512010
PE	250	1980	1981	512010
PE	250	1977	1978	512051
PE	250	1979	1979	512051
PE	250	1980	1981	512051
RGV GAMMA	250	1983	1983	512010
RGV GAMMA	250	1984	1984	512010
RGV GAMMA	250	1989	1990	512026
RGV GAMMA	250	1991	1991	512026
RGV GAMMA	250	1992	1993	512026
RGV GAMMA	250	1994	1994	512026
RGV GAMMA	250	1995	1996	512026
RGV GAMMA	250	1983	1983	512051
RGV GAMMA	250	1984	1984	512051
RL	250	1974	1975	493902
RS	250	1980	1981	512010
RS	250	1980	1981	512051
SP	250	1982	1983	493902
SP	250	1984	1984	493902
SP	250	1985	1985	493902
T	250	1969	1972	512007
TC	250	1969	1969	512007
TM	250	1970	1973	512007
TM	250	1974	1975	493902
TS	250	1970	1970	512007
TS	250	1971	1975	512007
TS	250	1976	1976	512007
TS	250	1969	1969	512008
TS	250	1977	1979	493902
TS	250	1980	1980	512010
TS	250	1981	1981	512010
TS	250	1985	1989	512017
TS	250	1980	1980	512051
TS	250	1981	1981	512051
GS	300	1982	1985	480602
T TC	305	1969	1969	512007
T	350	1969	1973	512007
DR	370	1978	1979	480603
SP	370	1978	1979	480603
GT	380	1972	1972	512006
GT	380	1973	1976	512006
GT	380	1977	1977	512006
GN	400	1980	1982	493902
GS	400	1977	1977	512006

ATHENA				
Modèle	Cylindre	Année début	Année fin	Réf.
GS	400	1978	1978	512006
GS	400	1991	1993	512024
PE	400	1980	1981	512010
PE	400	1980	1981	512051
SP	400	1980	1980	512010
SP	400	1980	1980	512051
TM	400	1971	1972	512007
TM	400	1973	1975	493902
TS	400	1971	1977	512007
GS	425	1979	1979	512006
GSE/L/S/T/LZ	450	1980	1982	512006
GSE/L/S/T/LZ	450	1983	1983	512006
GSE/L/S/T/LZ	450	1984	1984	512006
GSE/L/S/T/LZ	450	1985	1985	512006
GS LF/EG/SG/LJ	450	1983	1983	493902
GS LF/EG/SG/LJ	450	1984	1985	493902
GS LF/EG/SG/LJ	450	1986	1986	493902
GS LF/EG/SG/LJ	450	1987	1988	493902
GT	500	1975	1975	493902
GT	500	1976	1977	493902
GT	500	1978	1978	493902
RE	500	1975	1977	512008
RE M	500	1976	1976	493902
SP	500	1981	1983	512010
SP	500	1981	1983	512051
T	500	1968	1970	512007
T	500	1971	1975	512007
GS	550	1977	1977	493902
GS	550	1978	1978	493902
GS	550	1979	1980	493902
GS	550	1981	1982	493902
GS LD/LF	550	1983	1985	512015
G SX E	550	1984	1984	512015
G SX E	550	1985	1987	512015
GT	550	1972	1972	493902
GT	550	1973	1977	493902
SP F	600	1985	1985	512030
GR	650	1983	1985	493902
GS E	650	1981	1982	493902
GS E	650	1983	1983	493902
GS G/GL/M KATANA	650	1981	1982	493902
GS G/GL/M KATANA	650	1983	1983	493902
GS MD KATANA	650	1983	1983	512015
XN85	650	1983	1983	493902
GS	700	1985	1985	512015



JOINT SPI MOTO ANCIENNE / OLD MOTOORCYCLE FORK OIL SEAL

MOTEUR

CYCLE

PNEUMATIQUE

ATELIER

ACCESSOIRES

ÉLECTRICITÉ

FILTRATION

FREINAGE

TRANSMISSION

ATHENA				
Modèle	Cylindre	Année début	Année fin	Réf.
GS	750	1977	1978	493902
GS	750	1979	1979	493902
GS	750	1980	1980	493902
GS	750	1981	1981	493902
GS	750	1982	1983	493902
GS E / S KATANA	750	1983	1983	512014
GS	750	1979	1979	512015
GS	750	1980	1980	512015
GS	750	1981	1981	512015
GS	750	1982	1983	512015
GT	750	1972	1977	493902
GS	850	1979	1981	512014
GS	850	1982	1983	512014
GS	850	1984	1985	512014
GS	1000	1978	1978	512014
GS	1000	1979	1980	512014
GS	1000	1981	1981	512014
GS	1000	1982	1982	512014
GS ET / LT / EX / EZ / ESD / SD / KATANA	1100	1980	1980	512014
GS ET / LT / EX / EZ / ESD / SD / KATANA	1100	1981	1981	512014
GS ET / LT / EX / EZ / ESD / SD / KATANA	1100	1982	1982	512014
GS ET / LT / EX / EZ / ESD / SD / KATANA	1100	1983	1983	512014
GSX T / SX / SZ	1100	1980	1980	512014
GV GLF2 / GLF / GLG	1200	1985	1985	512024
GV GLF2 / GLF / GLG	1200	1986	1986	512024
GV	1400	1985	1985	512024
GV	1400	1986	1986	512024
GV	1400	1987	1988	512024
GV	1400	1989	1989	512024
YAMAHA				
IT	125	1980	1980	512004
IT	125	1981	1981	512008
MX	125	1974	1975	480600
MX	125	1976	1976	512007
RS DX	125	1976	1979	493904
RS DX	125	1980	1981	493904
CTI CT2 / CT3	175	1969	1973	480600
DT	175	1974	1976	480600
DT	175	1978	1978	512001
DT	175	1979	1980	512004
DT	175	1981	1981	512004
IT	175	1977	1978	480603

ATHENA				
Modèle	Cylindre	Année début	Année fin	Réf.
IT	175	1979	1979	480603
IT	175	1980	1981	480603
IT	175	1982	1983	512016
MX	175	1974	1975	480600
MX	175	1979	1981	512004
TY	175	1975	1976	480600
SR	185	1981	1982	493904
RD DX	200	1978	1978	480600
RD DX	200	1979	1980	480600
RD	200	1974	1976	480600
RD DX	200	1975	1975	493904
RD DX	200	1976	1977	493904
RD DX	200	1978	1978	493904
RS	200	1979	1979	480600
XT	200	1982	1983	512008
DT	250	1974	1975	512007
DT	250	1976	1976	512007
DT	250	1977	1978	512007
DT	250	1979	1982	480603
DTI DT2 / DT3 / CMX / EMX	250	1968	1971	512007
DTI DT2 / DT3 / CMX / EMX	250	1972	1972	512007
DTI DT2 / DT3 / CMX / EMX	250	1973	1973	512007
IT	250	1977	1978	480603
IT	250	1979	1980	480603
IT	250	1981	1982	512016
IT	250	1983	1983	512030
MX	250	1973	1975	512007
RD A / B / C / D / LC / YPVS	250	1980	1980	512003
RD A / B / C / D / LC / YPVS	250	1981	1982	512003
RD A / B / C / D / LC / YPVS	250	1983	1983	512003
RD A / B / C / D / LC / YPVS	250	1973	1975	512007
RD A / B / C / D / LC / YPVS	250	1977	1977	512007
RD A / B / C / D / LC / YPVS	250	1976	1976	512008
RD A / B / C / D / LC / YPVS	250	1978	1979	493902
SRX T / TC	250	1987	1987	480601
TD3	250	1972	1972	512007
TT G / H / J	250	1980	1982	480603
TY A / C / D	250	1974	1975	512007
TY A / C / D	250	1976	1977	512007

JOINT SPI MOTO ANCIENNE / OLD MOTOORCYCLE FORK OIL SEAL

CGN
LE SENS DU DÉTAIL

MOTEUR

CYCLE

PNEUMATIQUE

ATELIER

ACCESSOIRES

ÉLECTRICITÉ

FILTRATION

FREINAGE

TRANSMISSION

ATHENA				
Modèle	Cylindre	Année début	Année fin	Réf.
XS	250	1977	1977	512006
XS	250	1978	1978	512006
XS	250	1979	1980	512006
XS	250	1981	1981	512006
TR3	350	1972	1972	512007
TY	350	1985	1986	480603
TZ	350	1973	1973	512007
TZ	350	1976	1978	512008
DT	360	1974	1975	512007
MX	360	1973	1974	512007
RT1 RT2 / RT3	360	1970	1970	512007
RT1 RT2 / RT3	360	1971	1973	512007
XS	360	1975	1975	512006
XS	360	1976	1976	512006
XS	360	1977	1977	512006
XS	360	1978	1978	512006
DT	400	1975	1975	512007
DT	400	1976	1978	512007
IT	400	1976	1978	480603
IT	400	1979	1979	480603
MX	400	1976	1976	512007
RD	400	1976	1978	512007
RD	400	1979	1979	512008
XJ	400	-	-	493902
XS	400	1977	1979	512006
XS	400	1980	1981	512006
XS	400	1982	1982	512006
XS J / K DOHC	400	1982	1983	493902
IT	425	1980	1980	480603
IT H / J	465	1981	1982	512016
IT	490	1983	1983	512030
IT	490	1984	1984	512030
SC	500	1973	1974	512007
TX	500	1973	1975	512007
XS	500	1976	1976	493902
XS	500	1977	1977	493902
XS	500	1978	1981	493902
XV K VIRAGO	500	1983	1983	512010
XV K VIRAGO	500	1983	1983	512051
YZ	500	1982	1982	512030
XJ	550	1981	1981	493902
XJ	550	1982	1983	493902
XT	550	1982	1982	512016
XT	550	1983	1983	512016
TX	650	1973	1974	512007

ATHENA				
Modèle	Cylindre	Année début	Année fin	Réf.
TX	650	1975	1976	512007
XS1 / 2	650	1970	1971	512007
XS1 / 2	650	1972	1972	512007
XS	650	1975	1976	512007
XS	650	1977	1979	493902
XS	650	1980	1980	493902
XS	650	1981	1981	493902
XS	650	1982	1983	493902
FZX	700	1986	1986	512017
FZX	700	1987	1987	512017
XJ	700	1985	1985	512016
XJ	700	1986	1986	512016
TX	750	1973	1974	512008
TZ	750	1974	1977	512008
XJ	750	1982	1982	512010
XJ	750	1983	1983	512010
XJ R	750	1981	1983	512011
XJ	750	1982	1982	512051
XJ	750	1983	1983	512051
XS	750	1977	1977	493902
XS	750	1978	1978	512011
XS	750	1979	1979	512011
XS	850	1980	1980	512010
XS	850	1981	1981	512010
XS	850	1980	1980	512011
XS	850	1981	1981	512011
XS	850	1982	1982	512011
XS	850	1980	1980	512051
XS	850	1981	1981	512051
XV RH / J / RJ / K	920	1983	1983	512010
XV RH / J / RJ / K	920	1982	1982	512011
XV RH / J / RJ / K	920	1981	1981	512014
XV RH / J / RJ / K	920	1982	1982	512014
XV RH / J / RJ / K	920	1983	1983	512051
XJ	1100	1982	1982	512017
XS	1100	1979	1980	512012
XS	1100	1981	1981	512012
XS	1100	1978	1978	512014
XS	1100	1979	1980	512014
XS	1100	1981	1981	512014
ATI AT2 / AT3		1969	1973	480600



506770

506771



506769



506768



515260



292957



504974

/ PORTE VIGNETTE

Désignation	BLACKWAY	TUN'R
SUPPORT/PORTE VIGNETTE ASSURANCE BLACKWAY ACIER CHROME (ROND)	506770	
SUPPORT/PORTE VIGNETTE ASSURANCE BLACKWAY ACIER NOIR (ROND)	506771	
SUPPORT/PORTE VIGNETTE ASSURANCE BLACKWAY ALU CHROME (TUBE COURT) - 70MM	506769	
SUPPORT/PORTE VIGNETTE ASSURANCE BLACKWAY ALU NOIR (TUBE COURT) - 70MM	506768	
SUPPORT/PORTE VIGNETTE ASSURANCE BLACKWAY ALU ROUGE (TUBE COURT) - 70MM	515260	
SUPPORT/PORTE VIGNETTE ASSURANCE TUN'R ALU CHROME (ROND)		292957
SUPPORT/PORTE VIGNETTE ASSURANCE TUN'R ALU NOIR (CARRE)		504974



511606



511607



511605



487624

/ SUPPORT DE PLAQUE ORIENTABLE

Désignation	BLACKWAY	TUN'R
SUPPORT DE PLAQUE CNC ORIENTABLE BLACKWAY ALUMINIUM NOIR	511606	
SUPPORT DE PLAQUE CNC ORIENTABLE BLACKWAY ALUMINIUM NOIR - AVEC ECLAIRAGE DE PLAQUE	511605	
SUPPORT DE PLAQUE CNC ORIENTABLE BLACKWAY ALUMINIUM NOIR	511607	
SUPPORT DE PLAQUE ORIENTABLE TUN'R ALUMINIUM NOIR		487624



/ SUPPORT DE PHARE

Désignation	Réf.
SUPPORT PHARE/OPTIQUE MECABOITE OEM RIEJU MRT/MRT PRO/MARATHON (0/000.620.5301)	504156



/ SANGLE TETE DE FOURCHE

Désignation	Réf.
SANGLE TETE DE FOURCHE MECABOITE OEM RIEJU MRT/MRT PRO/SMX/MRX (0/000.360.0172) (X1)	504227





500836

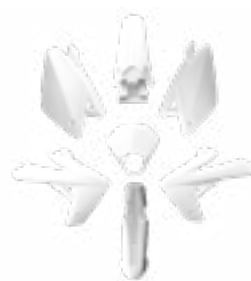

500835



518291



500834



518299



/ CARROSSERIE MECABOITE/MOTO RIEJU MRT/125 MARATHON -> 2022

Désignation	Réf.
BLANC (7 PCS)	500835
BLEU (7 PCS)	518291
NOIR (7 PCS)	500834
ROUGE (7PCS)	518299
ORANGE (7 PCS)	500836



500851



500854



500850



500853



518292

518293



500849

500852



518300

518301



/ COQUE AR MECABOITE/MOTO DROITE RIEJU MRT/MRT PRO/125 MARATHON

Désignation	DROITE	GAUCHE
09>2022 ORANGE	500851	500854
2009>2022 BLANC	500850	500853
2009->2022 BLEU	518292	518293
2009->2022 NOIR	500849	500852
2009>2022 ROUGE	518300	518301



518295



518294



518303



518302



500841



500856



500840



500855



500842



500857



/ GARDE BOUE AR MECABOITE/MOTO RIEJU MRT/MRT PRO/125 MARATHON 2009->2022

Désignation	AVANT	ARRIERE
BLEU	518295	518294
ROUGE	518303	518302
BLANC	500841	500856
NOIR	500840	500855
ORANGE	500842	500857



518296



518297



518304



518305



500844



500847



500843



500846



500845



500848



/ QUIE AV DROITE MECABOITE/MOTO RIEJU MRT/MRT PRO/125 MARATHON 2009->2022

Désignation	GAUCHE	DROITE
BLEU	518297	518296
ROUGE	518305	518304
BLANC	500847	500844
NOIR	500846	500843
ORANGE	500848	500845



/ TETE DE FOURCHE MECABOITE/MOTO RIEJU MRT/MRT PRO/125 MARATHON 09->2022

Désignation	TUNR
ORANGE	500839
BLANC	500838
BLEU	518298
NOIR	500837
ROUGE	518306



500839



500838



518298



518306



500837



/ TETE DE FOURCHE MECABOITE/MOTO/CYCLO CROSS 2

Désignation	Réf.
BLANC (DOUBLE OPTIQUE HALOGENE 2X20W)	376789*
NOIR (DOUBLE OPTIQUE HALOGENE 2X20W)	376808*



/ TETE DE FOURCHE MECABOITE/MOTO/CYCLO PLAQUE NUMERO CROSS

Désignation	Réf.
NOIR AVEC FIXATION	480452*



/ TETE DE FOURCHE MECABOITE/MOTO/CYCLO NUMERO

Désignation	Réf.
BLANC (DOUBLE OPTIQUE HALOGENE 2X20W)	440602*
NOIR (DOUBLE OPTIQUE HALOGENE 2X20W)	481187*



440602



481187



/ TETE DE FOURCHE MECABOITE/MOTO/CYCLO PLAQUE NUMERO CROSS TYPE KTM

Désignation	Réf.
BLANCHE AVEC FIXATION	481926*
NOIR AVEC FIXATION	481925*

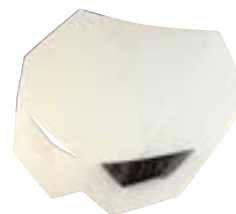

481926

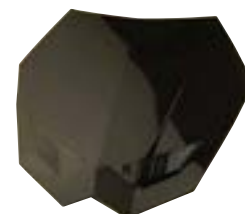

481925



/ TETE DE FOURCHE MECABOITE/MOTO/CYCLO XTREM RACE

Désignation	Réf.
NOIR (HALOGENE 2X20W (D50) LEDS BLAN	476767



/ TETE DE FOURCHE MECABOITE/MOTO/CYCLO RACING

Désignation	Réf.
BLANC (DOUBLE OPTIQUE HALOGENE 2X20W)TION	440598*
NOIR (DOUBLE OPTIQUE HALOGENE 2X20W)N	440601*



440598



440601



494126



494124



494125



494278

/ TETE DE FOURCHE MECABOITE/MOTO/CYCLO PLAQUE NUMERO CROSS TYPE YZ

Désignation	UFO	TUNR
BLANC	494126	
BLEU	494124	
NOIR	494125	
VERT		494278



/ PROTECTION FOURCHE MECABOITE/MOTO

Désignation	Réf.
50/125 MRT PRO/TROPHY/MARATHON PRO	517844



/ BAS DE CAISSE MAXI/SCOOTER



Désignation	Réf.
50/125 SR MOTARD/TYPHOON II-> 2T/4T (1B0005400XH1)	500522



/ CARROSSERIE MAXI SCOOTER

Désignation	Réf.
KIT ADAPT. 125 YAMAHA NMAX 2015->2020 NOIR BRILLANT (11 PCS)	520064
KIT ADAPT. 125 YAMAHA NMAX 2021-> NOIR BRILLANT (12 PCS)	520065
KIT ADAPT. 125 YAMAHA NMAX 2021-> NOIR MAT (12 PCS)	520066



/ CARROSSERIE MAXI SCOOTER

Désignation	Réf.
KIT ADAPT. 125/250 XMAX/SKYCRUISER ->2010 NOIR (11 PIECES)	480107



/ CARROSSERIE MAXI SCOOTER

Désignation	Réf.
KIT ADAPT. 125/300 YAMAHA XMAX 2018-> NOIR BRILLANT (15 PCS)	520068
KIT ADAPT. 125/300 YAMAHA XMAX 2018-> NOIR MAT (15 PCS)	520069



/ CARROSSERIE MAXI SCOOTER

Désignation	Réf.
KIT ADAPT. 125/300/400/500 MP3 08-13 NOIR BRILLANT (8 PCS)	499266
KIT ADAPT. 125/300/400/500 MP3 08-13 NOIR MAT (8 PCS)	499267



/ CARROSSERIE MAXI SCOOTER

Désignation	Réf.
KIT ADAPT. 500 YAMAHA TMAX 2008 ->2011 NOIR (9 PIECES)	487620



/ CARROSSERIE MAXI SCOOTER 530 YAMAHA TMAX

Désignation	Réf.
KIT ADAPT. BLANC 2015->2017 (14 PIECES)	493067
KIT ADAPT. NOIR 2015->2017 (14 PIECES)	493065
KIT ADAPT. NOIR MAT 2015->2017 (14 PIECES)	493066
KIT ADAPT. NOIR MAT 2017->2019 (15 PIECES)	518014



/ CARROSSERIE MAXI SCOOTER 560 YAMAHA TMAX

Désignation	Réf.
KIT ADAPT. NOIR BRILLANT 2020-> (15 PIECES)	515254
KIT ADAPT. NOIR MAT 2020-> (15 PIECES)	516982



/ COQUE AR SCOOTER/MAXI SCOOTER
50/125 KYMCO AGILITY RS/NAKED

Désignation	Réf.
NOIR (PEINT) (PR)	502122



/ TABLIER AR/PROTEGE JAMBE INTERIEUR SCOOTER
KYMCO 50/125 AGILITY 4T

Désignation	Réf.
4T NOIR	514017



500520

500521

/ REPOSE/CALE PIED SCOOTER PASSAGER

Désignation	GAUCHE	DROITE
50/125 SR motard/typhoon 1l	500521	500520



/ TABLIER AR/PROTEGE
JAMBE INTERIEUR SCOOTER
OEM PIAGGIO 50/125 SR MOTARD

Désignation	Réf.
2T 4T (85643300XHI)	500470



/ TABLIER AV/FACE AV SCOOTER/MAXI SCOOTER
50/125 KYMCO AGILITY

Désignation	Réf.
NOIR	514018
RS/NAKED NOIR	502121



502121



514018



/ GRILLE PROTECTION DECO

Désignation	Réf.
BLANC (29X35)	461186
BLEU ANODISE (29X35)	441927
CHROME (29X35)	441930
NOIR (29X35)	441931
OR (29X35)	441929
ORANGE (29X35)	486312
ROUGE ANODISE (29X35)	441928



461186



441927



441930



441931



441929



486312



441928



510944



335161



450783



485178



511007

/ AVERTISSEUR/KLAXON

Désignation	SELECTION CGN MOTORISE	TEKNIX	MASH
CYCLO/SCOOTER/MECABOITE/MOTO ADAPT. PEUGEOT KISBEE 12V (NOIR)	510944		
CYCLO/SCOOTER/MECABOITE/MOTO ADAPT. TOUS MODELES 12V	335161		
CYCLO/SCOOTER/MECABOITE/MOTO ADAPT. TOUS MODELES 12V (NOIR)	450783		
CYCLO/SCOOTER/MECABOITE/MOTO TEKNIX ADAPT. TOUS MODELES 12V (CHROME)		485178	
MECABOITE/MOTO ADAPT. MASH 50 FIFTY/DIRT TRACK/125 SEVENTY FIVE/CAFE RA			511007



486286



486289



486290



486291



450779



458483



477500

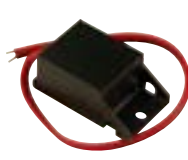

480370



458484



491059



511551



503208



503207

/ CENTRALE CLIGNOTANT MAXI SCOOTER

Désignation	GUILERA	SELECTION CGN MOTORISE	TUN'R	BLACKWAY	FLOSSER	TEKNIX
MAXI SCOOTER ADAPT. 125 BURGMAN/ 500/530 TMAX	486286					
MAXI SCOOTER ADAPT. 125 SKYLINER/MAJESTY	486289					
MAXI SCOOTER ADAPT. 125 XMAX/SKYCRUISER/EVOLIS	486290					
MAXI SCOOTER ADAPT. 125/400 XEVO/MP3/X8/X9	486291					
SCOOTER ADAPT. BOOSTER 04->/PIAGGIO 50/125 (2X10W)	450779					
UNIVERSELLE 2 FILS (0.1A 25 AMPERES) POUR LED		458483				
UNIVERSELLE 2 FILS CLIGNOTANT AMPOULE AVEC BUZZER 10W		477500				
UNIVERSELLE 2 FILS SPECIAL CLIGNOTANT 12V 0.05A ->10A POUR LED			480370			
UNIVERSELLE 3 FILS (0.1A 25 AMPERES) POUR LED		458484				
UNIVERSELLE 2 FILS SPECIAL CLIGNOTANT LED12V 0.1-150W				511551		
UNIVERSELLE 2 FILS (0.1A 25 AMPERES) POUR LEDS					491059	
UNIVERSELLE 2 FILS POUR LED						503208
UNIVERSELLE 3 FILS POUR LED						503207

/ CLIGNOTANT A LED



515606

ALHIR LED/FEU POSITION AVANT NOIR (PR)- HOMOLOGUE CE



515607

ALHIR LED/FEU POSITION AR/STOP NOIR (PR)- HOMOLOGUE CE



506633

ANDROMEDE + LEDSEQUENTIEL NOIR (PR)- HOMOLOGUECE



506634

ANDROMEDE LED NOIR (PR)- HOMOLOGUE CE



516995

ARDA LED NOIR (PR)- HOMOLOGUE CE



506759

ATOLLON LED NOIR (PR)- HOMOLOGUE CE- FIXATION RETRO/GUIDON



506762

ATZERRI LED NOIR (PR) - HOMOLOGUE CE



516984

BIOS LED NOIR (PR) - HOMOLOGUE CE



506642

BLAZARS LED BLEU (PR)- HOMOLOGUE CE



506640

BLAZARS LED NOIR (PR)- HOMOLOGUE CE



510060

BLAZARS LED ORANGE (PR)- HOMOLOGUE CE



506641

BLAZARS LED ROUGE (PR)- HOMOLOGUE CE



/ COQUE CLIGNOTANT

Désignation

Réf.

COQUE CLIGNOTANT BLACKWAY BLAZARS INTERCHANGEABLE NOIR/ORANGE/ROUGE /BLEU/ JAUNE(5PR)

506643



515608

BOROSK LED/FEU POSITION AR/STOP NOIR (PR)- HOMOLOGUE CE



515609

BOROSK LED/FEU POSITION AVANT NOIR (PR)- HOMOLOGUE CE



517028

DE CARENAGE LED NOIR (PR) SPECIAL MP3 - HOMOLOGUE CE

MOTEUR

CYCLE

PNEUMATIQUE

ATELIER

ACCESSOIRES

ÉLECTRICITÉ

FILTRATION

FREINAGE

TRANSMISSION



516983

EGO LED NOIR (PR) - HOMOLOGUE CE



516985

FELIS LED NOIR (PR)- HOMOLOGUE CE



506767

HAPES LED SEQUENTIEL NOIR (PR)
- HOMOLOGUE CE



508044

KIROS LED NOIR MATT (PR)- HOMOLOGUE
CE



510919

MINI ATOLLON LED NOIR (PR) -
HOMOLOGUE CE- FIXATION RETRO/
GUIDON



506766

PANTORA LED NOIR (PR)
- HOMOLOGUE CE



506636

PEGASE + LED/FEU POSITION/ARRIERE
NOIR FUME (PR) - HOMOLOGUE CE



506635

PEGASE LED NOIR FUME (PR)
- HOMOLOGUE CE



506637

PHENIX LED NOIR (PR)- HOMOLOGUE CE



506644

QUASAR + LED SEQUENTIEL NOIR (PR)
- HOMOLOGUE CE



506645

QUASAR LED NOIR(PR)- HOMOLOGUE CE



506657

RISHI LED NOIR (PR) - HOMOLOGUE CE



517264

SKARO LED NOIR (PR)- HOMOLOGUE CE



517265

SOROR LED NOIR (PR) - HOMOLOGUE CE



510100

SUPERNOVA + LED SEQUENTIEL/FEU
POSITION AVANT NOIR (PR)-HOMOLOGUE C



506639

SUPERNOVA + LEDSEQUENTIEL NOIR (PR)
- HOMOLOGUECE



506638

SUPERNOVA LED NOIR (PR)
- HOMOLOGUE CE



506661

CLIGNOTANT BLACKWAY ZAKEL LED NOIR
(PR)



506654

METALHORN ALU LED SEQUENTIEL NOIR (PR) - HOMOLOGUE CE - FIX. RETRO



501891

CLIGNOTANT TUN'R MINI LED NOIR/FUME (PR) HOMOLOGUE CE



480680

CLIGNOTANT TUN'R MINI WINKER NOIR/ TRANSPARENT 8 LEDS (PR) HOMOLOGUE CE



494383

SMOGG LED NOIR/TRANSPARENT (PR)



497573

DUAL NOIR/TRANSPARENT A LED SMD AVEC FEU POSITION BLANC AV (PR) HOMOLOGUE



497572

DUAL NOIR/TRANSPARENT A LED SMD AVEC FEU STOP (PR) HOMOLOGUE CE



502237

NOIR ALU A LED SEQUENTIEL - SQ2 (PR) HOMOLOGUE CE

/ CLIGNOTANT A AMPOULE



506764

BYSS ALU AMPOULE NOIR (PR) - HOMOLOGUE CE



506650

CORELLIA AMPOULE NOIR (PR) - HOMOLOGUE CE



506651

MIRIAL AMPOULE NOIR FUME (PR) - HOMOLOGUE CE



506653

NIXUS AMPOULE NOIR (PR) - HOMOLOGUE CE



506655

PANTORA AMPOULE NOIR (PR) - HOMOLOGUE CE



506656

QUELL AMPOULE NOIR (PR) - HOMOLOGUE CE



506658

TARIS AMPOULE NOIR (PR) - HOMOLOGUE CE



506662

TELTI ALU AMPOULE NOIR (PR) - HOMOLOGUE CE



489442

BLINKER NOIR RUBBER/FUME A AMPOULE (PR) HOMOLOGUE CE

MOTEUR

CYCLE

PNEUMATIQUE

ATELIER

ACCESSOIRES

ÉLECTRICITÉ

FILTRATION

FREINAGE

TRANSMISSION

TUN'R



487546

INDICATOR CARBONE/TRANSPARENT
A AMPOULE (PR) HOMOLOGUE CE

TUN'R



487544

INDICATOR NOIR/TRANSPARENT
A AMPOULE (PR) HOMOLOGUE CE

TUN'R



473397

MICRO TRIANGLE CARBONE/ORANGE
A AMPOULE (PR) HOMOLOGUE CE

TUN'R



473396

MICRO TRIANGLE NOIR/ORANGE
A AMPOULE (PR) HOMOLOGUE CE

TUN'R



487557

MINI TRIANGLE NOIR/TRANSPARENT A
AMPOULE (PR) HOMOLOGUE CE

TUN'R



458486

OVAL MICRO F.COURTE NOIR/ORANGE A
AMPOULE (12V 21W) (PR) HOMOLOGUE CE

TUN'R



497900

VISION NOIR ALU A AMPOULE (PR)
HOMOLOGUE CE

TUN'R



440127

RECTANGLE F.COURTE NOIR/
TRANSPARENT+AMPOULES ORANGE (PR)

TUN'R



480272

TRIANGLE F.COURTE BLANC/
TRANSPARENT AMPOULE ORANGE (PR)

TUN'R



449942

TRIANGLE F.COURTE CARBONE/
TRANSPARENT AMPOULE ORANGE (PR)

TUN'R



497612

AMBIANCE NOIR/FUME (PR)
HOMOLOGUE CE

TUN'R



497611

RUBIS NOIR/FUME (PR)
HOMOLOGUE CE

TUN'R



450460

GOUTTE D'EAU MINI AUTOCOLLANT
FUME/CARBONE (PR)

/ FEU DECORATIF



480360

GOUTTE D'EAU FUTUR TRANSPARENT/
BLANC (PR)



473399

GOUTTE D'EAU FUTUR TRANSPARENT/
CARBONE (PR)



473398

GOUTTE D'EAU FUTUR TRANSPARENT/
CHROME (PR)



283258

GOUTTE D'EAU MICRO
AUTOCOLLANT CHROME/
TRANSPARENT (PR)



451580

GOUTTE D'EAU MICRO CLIPS
ECLAIRAGE ORANGE/CARBONE
(PR)



451583

GOUTTE D'EAU MICRO CLIPS
ECLAIRAGE ORANGE/CHROME
(PR)



451581

GOUTTE D'EAU MICRO CLIPS
ECLAIRAGE ORANGE/NOIR (PR)



517663



517664



517662



506648



506647



506646



517359



517365



517360



517361



517364



517362



517363



/ RALLONGE CLIGNOTANT CRESCENTIA

Désignation	Réf.
NOIR (PR) - M10/M10 LONG 37.5MM	506648
NOIR (PR) - M8/M10 LONG 37.5MM	506647
NOIR (X1) - M8/M8 LONG 25MM	506646



506863

506864



/ RESISTANCE POUR CLIGNOTANTS

Désignation	Réf.
10W / 10 OHMS (PR)	506863
20W / 10 OHMS (PR)	506864
20W / 15 OHMS (PR)	506865



/ CACHE ORIFICE CLIGNOTANT

Désignation	Réf.
ADAPT. DUCATI ARRIERE (2 PIECES)	517663
ADAPT. DUCATI AVANT (2 PIECES)	517664
ADAPT. DUCATI/BMW/CAGIVA/BENELLI/HONDA/ ITALJET (2 PIECE)	517662
HONDA (4 PIECES)	517359
HONDA/SUZUKI (4 PIECES)	517365
KAWASAKI (4 PIECES)	517360
SUZUKI V1 (4 PIECES)	517361
SUZUKI V2 (4 PIECES)	517364
YAMAHA V1 (4 PIECES)	517362
YAMAHA V2 (4 PIECES)	517363

MOTEUR

CYCLE

PNEUMATIQUE

ATELIER

ACCESSOIRES

ÉLECTRICITÉ

FILTRATION

FREINAGE

TRANSMISSION

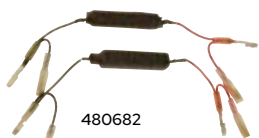

480682



468228



/ RESISTANCE POUR CLIGNOTANTS LED

Désignation	Réf.
AVEC CONNECTIQUE 10 OHMS POUR 10W (X2)	480682
AVEC CONNECTIQUE 12 OHMS POUR 10W (X2)	468228



511989



511992



/ RESISTANCE POUR CLIGNOTANTS LED

Désignation	Réf.
25W 10 OHMS (X1)	511989
25W 6.8 OHMS (X1)	511992



484273



501095



496143



476758



512240



512241

/ COMMODO/COMMUTATEUR UNIVERSEL

Désignation	SELECTION CGN MOTORISE	TEKNIX	TUN'R
DOMINO ON/OFF UNIVERSEL NOIR	484273		
ON/OFF UNIVERSEL NOIR (BOUTON POUSSOIR)		501095	
CROSS UNIVERSEL NOIR - AVEC BOUTON ECLAIRAGE/CLIGNOTANT/AVERTISS			496143
CROSS UNIVERSEL NOIR - AVEC BOUTON ON-OFF			476758
VINTAGE CHROME UNIVERSEL 2 POSITIONS ET BOUTON	512240		
VINTAGE CHROME UNIVERSEL 3 POSITIONS ET 2 BOUTONS	512241		



510982



500356



500357

/ COMMODO

Désignation	MASH	TEKNIX
COMMODO/COMMUTATEUR DROIT MECABOITE/MOTO ADAPT. MASH 50 FIFTY 17->/125 SEVENTY FIVE/CAFE	510982	
COMMODO/COMMUTATEUR DROIT TEKNIX COMPLET ADAPT. KYMCO AGILITY 04-> 2ET 4 TEMPS/125/SUPER 8		500356
COMMODO/COMMUTATEUR GAUCHE SCOOTER TEKNIX COMPLET ADAPT. KYMCO AGILITY/50/125/SUPER 8		500357

/ CONTACTEUR INTERRUPTEUR

Désignation	SELECTION CGN MOTORISE	TEKNIX
CONTACTEUR/INTERRUPTEUR ON/OFF STANDARD A LEVIER	478381	
CONTACTEUR/INTERRUPTEUR ON/OFF TEKNIX ENCASTRABLE		479499



478381



479499



/ CONTACTEUR INTERRUPTEUR

Désignation	SELECTION CGN MOTORISE	TEKNIX
CONTACTEUR / INTERRUPTEUR A LED BLEU LOQUET ROUGE	472436	
CONTACTEUR / INTERRUPTEUR A LED ROUGE LOQUET NOIR		472438



/ AVERTISSEUR



Désignation	Réf.
BOUTON POUSSOIR/CONTACTEUR AVERTISSEUR/KLAXON AVEC FIL ET COLLIER (MISE A LA MASSE)	482017



517532



517538



517533



517534



517535



517536



319894



517537



252609



479116



/ CONTACTEUR DE STOP

Désignation	Réf.
AV MOTO ADAPT. HONDA (35340-GS7-023)	517532
AV MOTO ADAPT. HONDA (35340-MA5-671/35340-MM5-600)	517538
AV MOTO ADAPT. HONDA (35350-292-003)	517533
AV MOTO ADAPT. KAWASAKI / SUZUKI (57460-17C01-000)	517534
AV MOTO ADAPT. SUZUKI (57460-17J01-000)	517535
AV MOTO/MAXISCOOTER ADAPT. MBK/YAMAHA (2UJ-83980-00)	517536
SCOOTER ADAPT. F10/F15 (CLIPSABLE) D8.5MM	319894
SCOOTER DROIT ADAPT. BOOSTER/NITRO (5JH-H3980-03)	517537
UNIVERSEL ADAPTABLE (D6) A VISSER	252609
UNIVERSEL GRIS A VISSER	479116



/ OPTIQUE/PHARE/PROJECTEUR ADDITIONNEL

Désignation	Réf.
HALOGENE BLANC D35 ORIENTABLE 12V 20W	488146
HALOGENE NOIR 12V35W HOMOLOGUE ORIENTABLE	482968
HALOGENE NOIR 12V55W HOMOLOGUE ORIENTABLE	482969
HALOGENE BLANC D50 ORIENTABLE (X1) 12V 20	482967
HALOGENE CARBONE D35 ORIENTABLE 12V 20W X1	441885
HALOGENE CARBONE D50 ORIENTABLE X1 12V 20W	482966
HALOGENE NOIR D35 ORIENTABLE X1 12V 20W	441886
HALOGENE NOIR D50 ORIENTABLE (X1) 12V 20W	482965
6 LED NOIR ORIENTABLE	518711
LED NOIR ORIENTABLE X1 12V 10W L85MM	500859



/ OPTIQUE

Désignation	RIEJU	MASH	TEKNIX
MECABOITE OEM RIEJU MRT/MRT PRO/MARATHON/BUY BIKE/TANGO (0/000.600.0260)	504191		
MECABOITE/MOTO ADAPT. MASH 50 FIFTY/125 SEVENTY FIVE/CAFE RACER/SCRAMBLER DI55 MM		510996	
SCOOTER TEKNIX ADAPT. SYM 50/125 FIDDLE 2 (TYPE 33100-ALA-000-5)			511242
SCOOTER TEKNIX ADAPT. SYM 50/125 ORBIT II			521443
SCOOTER TEKNIX ADAPT. VESPA LX 50/125 HOMOLOGUE CE			485977



/ ECLAIRAGE DE PLAQUE

Désignation	BLACKWAY	RIEJU	TUN'R
ALU NOIR 4 LEDS - HOMOLOGUE CE	510129		
NOIR 3 LEDS - HOMOLOGUE CE	506659		
MRT/MRT PRO/RS3 2018- > 125 MARATHON/RS2/RS3/ NUUK		517750	
4 LEDS BLANCHES (x1) HOMOLOGUE			466090
3 LEDS BLANCHES (x1)			517794

/ FEU ARRIERE



493076

MAXI SCOOTER/MOTO ADAPT. 530 TMAX
->17/YZF R1 07->08 FUME LEDS FOGGY
HOMOLOGUE CE



499108

MECABOITE ADAPT. XLIMIT/DT50 03->/XT
125 05->08/SHERCO 06->12 ROUGE



518719

MECABOITE/MOTO LEDS ADAPT. RIEJU
MRT/MRT PRO/125 MARATHON >22



503675

SCOOTER ADAPT. 50/125 SYM FIDDLE 2



521435

SCOOTER ADAPT. 50/125 SYM ORBIT 2



485976

SCOOTER ADAPT. VESPA LX 50/125



467868

MECABOITE/MOTO TRANSPARENT LEDS ADAPT.
GPR 50/125 10->/BETA 50 18-> -HOMOLOGUE



511001

MECABOITE/MOTO ADAPT. 50 FIFTY/125
CAFE RACER/BLACK SEVEN



518718

MECABOITE/MOTO LEDS ADAPT. RIEJU
MRT/MRT PRO/125 MARATHON ->22



504190

MECABOITE/MOTO OEM MRT/MRT PRO/125
MARATHON ->22 (0/000.150.2020) A LEDS



519896

MECABOITE INTEGRE ROUGE LEDS BAVETTE
NE SUPPORTE PAS PLAQUE IMMAT -NOIR



497896

MECABOITE INTEGRE TRANSPARENT 12 LEDS
HOMOLOGUE CE AVEC SUPPORT PLAQUE



497898

MECABOITE INTEGRE TRANSPARENT 12 LEDS
HOMOLOGUE CE AVEC SUPPORT PLAQUE



462566

MECABOITE INTEGRE TRANSPARENT LEDS
BAVETTE NE SUPPORTANT PAS PLAQUE
IMMAT



519897

MECABOITE INTEGRE TRANSPARENT LEDS
BAVETTE NE SUPPORTE PAS PLAQUE IMMAT
-NOIR



496106

MECABOITE/MOTO INTEGRE FUME A 6 LEDS
HOMOLOGUE CE SANS SUPPORT PLAQUE



497897

MECABOITE/MOTO INTEGRE ROUGE A 12
LEDS HOMOLOGUE CE AVEC SUPPORT
PLAQUE ALU



462565

MECABOITE/MOTO INTEGRE ROUGE A LEDS
HOMOLOGUE CE SANS SUPPORT PLAQUE





485973

FUME MINI AVEC ECLAIRAGE DE PLAQUE
HOMOLOGUE CE



493089

ROUGE FOGGY MINI AVEC ECLAIRAGE
DE PLAQUE HOMOLOGUE CE



282763

FEU AR UNIVERSEL TUN'R
CROSS/ENDURO ROUGE/NOIR

/ FEU ARRIERE DECORATIF LEDS



490354

A LEDS FIX. VERTICALE ADAPT. BETA
RR/TZR FUME HOMOLOGUE CE



467864

A LEDS FIX. VERTICALE ADAPT. BETA
RR/TZR ROUGE HOMOLOGUE CE



467865

A LEDS FIX. VERTICALE ADAPT. BETA
RR/TZR TRANSPARENT HOMOLOGUE CE



490445

A LEDS FIX. VERTICALE CLIGNO INTEGR
ADAPT. BETA RR/TZR FUME HOMOLO



459797

A LEDS OVALE NID D'ABEILLES
TRANSPARENT HOMOLOGUE CE



483392

A LEDS TRANSPARENT (6 LEDS)
HOMOLOGUE CE



478329

A LEDS TRANSPARENT BARRETTE
HOMOLOGUE CE



483393

FUME 6 LEDS HOMOLOGUE CE



493088

FUME LED FOGGY MINI AVEC ECLAIRAGE
DE PLAQUE HOMOLOGUE CE



475842

MINI TRIANGLE A LEDS (POUR BAVETTE
462566/462565)



497578

FEU AR UNIVERSEL TUN'R A LEDS FIXATION
VERTICALE ROUGE



497576

A 9 LEDS FUME AVEC SUPPORT ET
ECLAIRAGE DE PLAQUE HOMOLOGUE CE

/ FEU DÉCORATIF 3M 18 LEDS BANDE DE 30CM



482315

18 LEDS BLANC FIXES



482314

18 LEDS BLEU FIXES



482318

18 LEDS ORANGE FIXES



482317

18 LEDS ROUGE FIXES

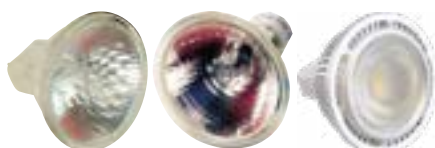

455206

333677

494327



/ LAMPE/AMPOULE DICHROIQUE

Désignation	Réf.
12V 20W HALOGENE D35 BLANC (X1)	455206
12V 20W HALOGENE D50 BLANC (X1)	333677
12V 35W (MR16) 1 LED 120 LUMENS BLANC DIAM.50	494327



/ LAMPE CLIGNOTANT



Désignation	Réf.
12V 10W (BA15S) TUN'R CLIGNO ORANGE (X4) ADAPT. BOOSTER SPIRIT/BW'S	333427



500412

500290

283554

489606

489607

500432

500284

500426

2729

500411

500287

450661

/ LAMPE FEU, GRAISSEUR 12V BA15S

Désignation	NEOLUX	OSRAM	FLOSSER
LAMPE/AMPOULE 12V 5W (BA15S) NEOLUX	500412		
LAMPE/AMPOULE 12V 5W (BA15S) NEOLUX CLIGNOTANT/STOP (BLISTER DE 2)	500290		
LAMPE/AMPOULE 12V 5W (BA15S) OSRAM GRAISSEUR		283554	
LAMPE/AMPOULE 12V 10W (BA15S) FLOSSER GRAISSEUR BLANC			489606
LAMPE/AMPOULE 12V 10W (BA15S) FLOSSER GRAISSEUR ORANGE			489607
LAMPE/AMPOULE 12V 10W (BA15S) NEOLUX GRAISSEUR	500432		
LAMPE/AMPOULE 12V 10W (BA15S) NEOLUX GRAISSEUR (BLISTER DE 2)	500284		
LAMPE/AMPOULE 12V 10W (BA15S) NEOLUX LED (1.2W) GRAISSEUR (BLISTER DE 2)	500426		
LAMPE/AMPOULE 12V 10W (BA15S) OSRAM GRAISSEUR		2729	
LAMPE/AMPOULE 12V 21W (BA15S) NEOLUX	500411		
LAMPE/AMPOULE 12V 21W (BA15S) NEOLUX (BLISTER DE 2)	500287		
LAMPE/AMPOULE 12V 21W (BA15S) OSRAM CLIGNOTANT/STOP		450661	

/ LAMPE FEU, GRAISSEUR 12V BA9S

Désignation	NEOLUX	OSRAM	TUN'R
12V 4W (BA9S) NEOLUX LED (0.5W) TEMOIN X2	500429		
12V 4W (BA9S) NEOLUX TEMOIN	500283		
12V 4W (BA9S) OSRAM TEMOIN		2737	
12V 21W (BA9S) TUN'R MINI CLIGNO BLANC (X1)			450462



500429

500283

2737

450462



500639

450463

450464

/ LAMPE FEU, GRAISSEUR 12V BAX9S

Désignation	NEOLUX	TUN'R
LAMPE/AMPOULE 12V 6W (BAX9S ERGOT DECALE) H6W NEOLUX MINI CLIGNO BLANC	500639	
LAMPE/AMPOULE 12V 21W (BAX9S ERGOT DECALE) TUN'R MINI CLIGNO BLANC LONG (X1)		450463
LAMPE/AMPOULE 12V 21W (BAX9S ERGOT DECALE) TUN'R MINI CLIGNO ORANGE LONG (X1)		450464

MOTEUR

CYCLE

PNEUMATIQUE

ATELIER

ACCESSOIRES

ÉLECTRICITÉ

FILTRATION

FREINAGE

TRANSMISSION



/ LAMPE FEU, GRAISSEUR 12V BAU15S

Désignation	NEOLUX	OSRAM	FLOSSER
LAMPE/AMPOULE 12V 10W (BAU15S ERGOT DECALE) NEOLUX GRAISSEUR ORANGE	500645		
LAMPE/AMPOULE 12V 21W (BAU15S ERGOT DECALE) NEOLUX CLIGNOTANT ORANGE	500431		
LAMPE/AMPOULE 12V 21W (BAU15S ERGOT DECALE) NEOLUX CLIGNOTANT ORANGE (BLISTER DE 2)	500430		
LAMPE/AMPOULE 12V 21W (BAU15S ERGOT DECALE) OSRAM CLIGNOTANT ORANGE		464933	
LAMPE/AMPOULE 12V 21W (BAU15S) FLOSSER CLIGNOTANT			491056
LAMPE/AMPOULE 12V 21W (BAU15S) FLOSSER CLIGNOTANT ORANGE			491054
LAMPE/AMPOULE 12V 21W (BAU15S) FLOSSER PRW21W - ROUGE - CLIGNOTANT OU STOP			507559

/ LAMPE FEU, GRAISSEUR BAY15D

Désignation	FLOSSER	NEOLUX	OSRAM	TUN'R
6V 21/5W FEU+STOP	506893			
12V 21/5W (LED 1.2W) FEU+STOP (BLISTER DE 2)		500428		
12V 21/5W FEU+STOP		500427		
12V 21/5W FEU+STOP (BLISTER DE 2)		500282		
12V 21/5W FEU+STOP			173635	
12V 21/5W FEU+STOP ROUGE (X4)				333431
12V 23/8W FEU/STOP TRANSPARENT (X4)				450110



/ LAMPE FEU, GRAISSEUR 6V

Désignation	Réf.
6V 10W (BA15S) FLOSSER GRAISSEUR	461975
6V 21W (BA15S) FLOSSER	487500



/ LAMPE FEU, GRAISSEUR 6V BA7S

Désignation	Réf.
6V 1.2W (BA7S) GRAISSEUR FLOSSER	506894



/ LAMPE FEU, GRAISSEUR 6V BA9S

Désignation	Réf.
6V 4W (BA9S) FLOSSER TEMOIN	461978



/ LAMPE FEU, GRAISSEUR 12V BA7S

Désignation	Réf.
LAMPE/AMPOULE 12V 2W (BA7S) GRAISSEUR FLOSSER	487501



/ LAMPE PROJECTEUR 12V

Désignation	FLOSSER	TUR'N	NEOLUX	OSRAM
15W (P26S)	461976			
15W (P26S) HALOGENE COLLERETTE (XI)		2699		
25/25W (BA20D) HOMOLOGUEE	479415			
25/25W POUR TETE DE FOURCHE		472832		
25W (P26S)	506889			
35/35W (BA20D S2) HALOGENE (BLISTER)			500250	
35/35W (BA20D S2) HALOGENE				487515
35/35W (BA20D)	478465			
35/35W (BA20D) HALOGENE	495302			
35/35W (BA20D) HALOGENE BLEU	495303			
35/35W (PX43T) HSI			500434	
35/35W (PX43T) HSI (BLISTER)			500439	
35/35W (PX43T) HSI				363012
35/35W HALOGENE POUR TETE DE FOURCHE		472834		
35W (H8) (PGJ19-1)			500418	
35W (H8) (PGJ19-1)				487242
45/40W (BA20D)	491050			
45/40W (P45t)	506892			
55W (HI)			500435	
55W (HI) - BLUE LIGHT			500442	
55W (HI) (BLISTER)			500416	
55W (HI)				492285



/ LAMPE PROJECTEUR 12V BAZ9S

Désignation	Réf.
LAMPE/AMPOULE 12V 6W (BAZ9S) FLOSSER HALOGENE ORANGE - ERGOT DECALE	521112



/ LAMPE PROJECTEUR 12V P15D 25-1

Désignation	Réf.
LAMPE/AMPOULE 12V 35/35W (P15d 25-1) FLOSSER PROJECTEUR	506890



NEOLUX

/ LAMPE PROJECTEUR 12V P20D

Désignation	Réf.
LAMPE/AMPOULE 12V 60W (HB3) NEOLUX PROJECTEUR (P20D)	500637



/ LAMPE PROJECTEUR 12V P43T

Désignation	NEOLUX	OSRAM
60/55W (H4) PROJECTEUR (P43T)	500438	
60/55W (H4) PROJECTEUR (P43T) - BLUE LIGHT (BOITE DE 2)	500443	
60/55W (H4) PROJECTEUR (P43T) (BLISTER)	500289	
60/55W (H4) PROJECTEUR (P43T)		283569
H4 P43T LEDRIVING LED - 6000K - PACK DE 2		519955



500438

500443

500289

283569

519955

/ LAMPE PROJECTEUR 12V PGJ19-2

Désignation	NEOLUX	OSRAM
12V 55W (H11) PROJECTEUR (PGJ19-2) - BLUE LIGHT	500445	
12V 55W (H11) PROJECTEUR (PGJ19-2) (BLISTER)	500446	
12V 55W (H11) PROJECTEUR (PGJ19-2)		490706



500445

500446

490706

OSRAM

/ LAMPE PROJECTEUR 12V PGJ19-5

Désignation	Réf.
LAMPE/AMPOULE 12V 65W (H9) OSRAM PROJECTEUR (PGJ19-5)	490704



/ LAMPE PROJECTEUR 12V PK22S

Désignation	NEOLUX	OSRAM
12V 55W (H3) PROJECTEUR (PK22S)	500436	
12V 55W (H3) PROJECTEUR (PK22S) - BLISTER	500417	
12V 55W (H3) PROJECTEUR (PK22S)		490707



500436

500417

490707

/ LAMPE PROJECTEUR 12V PX26D

Désignation	NEOLUX	OSRAM
12V 55W (H7) PROJECTEUR (PX26D)	500437	
12V 55W (H7) PROJECTEUR (PX26D) - BLUE LIGHT	500444	
12V 55W (H7) PROJECTEUR (PX26D) BLISTER	500286	
12V 55W (H7) PROJECTEUR (PX26D)		211804
12V H7 PX26D LEDRIVING LED - 6000K - PACK DE 2		519956



500437

500444



500286

211804

519956



/ LAMPE PROJECTEUR 6V



461977 506888

Désignation	FLOSSER
6V 15W (P26S) PROJECTEUR	461977
6V 35/35W (BA20D) PROJECTEUR	506888



/ LAMPE PROJECTEUR 6V P45T



Désignation	Réf.
LAMPE/AMPOULE 6V 45/40W (P45t) FLOSSER PROJECTEUR	506891



/ LAMPE/AMPOULE

Désignation	Réf.
12V - COFFRET H4	500642
12V - COFFRET H7	500643



500642 500643



/ LAMPE/AMPOULE

Désignation	Réf.
12V - PRESENTOIR MURAL 120 PCS)	515985



/ LAMPE/AMPOULE 12V 1.2W T5

Désignation	NEOLUX	OSRAM
12V 1.2W (W1.2W) WEDGE TEMOIN T5 (W2X4.6D) ECLAIRAGE COMPTEUR	500288	
12V 1.2W (W1.2W) WEDGE TEMOIN T5 (W2X4.6D) ECLAIRAGE COMPTEUR		464934



500288 464934



/ LAMPE/AMPOULE 12V 3W T10

Désignation	Réf.
12V 3W (W3W) WEDGE TEMOIN T10 (W2.1X9.5D) CULOT DE VERRE	500640



500433



500641



500285



464935

/ LAMPE/AMPOULE 12V 5W T10

Désignation	NEOLUX	OSRAM
LAMPE/AMPOULE 12V 5W (W5W) WEDGE NEOLUX TEMOIN T10 (W2.1X9.5D) CULOT DE VERRE	500433	
LAMPE/AMPOULE 12V 5W (W5W) WEDGE NEOLUX TEMOIN T10 (W2.1X9.5D) CULOT DE VERRE - ORANGE	500641	
LAMPE/AMPOULE 12V 5W (W5W) WEDGE NEOLUX TEMOIN T10 (W2.1X9.5D) CULOT DE VERRE BLISTER X2	500285	
LAMPE/AMPOULE 12V 5W (W5W) WEDGE OSRAM TEMOIN T10 (W2.1X9.5D) CULOT DE VERRE		464935



/ LAMPE/AMPOULE TÉMOIN TABLEAU DE BORD

Désignation	FLOSSER	NEOLUX
LAMPE/AMPOULE 6V 5W FLOSSER FEU DE POSITION (NAVETTE C5W SV8.5 11X35)	491060	
LAMPE/AMPOULE 6V 10W FLOSSER (NAVETTE C10W SV8.5 11X40)	491062	
LAMPE/AMPOULE 12V 5W (C5W) NEOLUX FEU DE POSITION (NAVETTE SV8.5 11X35)		500421
LAMPE/AMPOULE 12V 10W (C10W) NEOLUX FEU DE POSITION (NAVETTE SV8.5 11X35)		500644
LAMPE/AMPOULE 12V 5W (C5W) FLOSSER FEU DE POSITION (NAVETTE SV8.5 11X35)	491061	



/ PATTE SUPPORT PHARE

Désignation	Réf.
PATTE/SUPPORT/FIXATION PROJECTEUR/PHARE/OPTIQUE TUN'R D35-48 NOIR (PR)	489445



/ PORTE AMPOULE/LAMPE

Désignation	Réf.
12V BA15S - AVEC CABLE	509363
12V BA9S - AVEC CABLE	509368
12V BAU15S - AVEC CABLE	509365
12V BAY15D - AVEC CABLE	509364
12V H1	509359
12V H1 - AVEC CULOT	509358
12V H4 - AVEC CABLE	509357
12V H7 - AVEC CABLE	509360

Désignation	Réf.
12V H8/H9/H11 - AVEC CABLE	509356
12V HB3/H10/H12 - AVEC CABLE	509361
12V HB4 - AVEC CABLE	509362
12V W2.1X9.5D -	509369
12V W2.5X16D - AVEC CABLE	509367
12V W21W - AVEC CABLE	509366
12V W2X4.6D - AVEC CABLE	509370

DELITIRE

DRIVE YOUR SOUL



Voltrax
SC-115

Razor XP
SB-148

Slash
SB-151

Contrôlez la route!

Obtenez toute la puissance et la sécurité de votre moto grâce à nos pneus.

DeliTire.com 

[SwallowDelitireDelium](#) 

[Delitireofficial](#) 

PT. INDUSTRI KARET DELI
JL. Kom. Laut Yos Sudarso - km 8.3 Medan 20241
North Sumatera - Indonesia
Email: sales@delitire.com

/ PNEUS SCOOTER / SCOOTER TYRES	322
/ PNEUS MOTO / MOTORCYCLE TYRES	342
/ PNEUS CYCLO / MOPED TYRES	362
/ CHAMBRE A AIR SCOOTER / INNER TUBE	368
/ CHAMBRE A AIR MOTO / INNER TUBE	371
/ CHAMBRE A AIR CYCLO / INNER TUBE	373
/ FOND DE JANTE CYCLO & MOTO / RIM LINER	375



MOTEUR

CYCLE

PNEUMATIQUE

ATELIER

ACCESSOIRES

ÉLECTRICITÉ

FILTRATION

FREINAGE

TRANSMISSION

Pouces	Dimensions	MICHELIN		Continental <small>The Future is Now</small>		DUNLOP		
		Réf.	Modèle	Réf.	Modèle	Réf.	Modèle	
8"	3,50 x 8	320344	S83					
	4,00 x 8							
9"	2,75 x 9	320363	ACS					
10"	3,00 x 10	493211	S1	495900	CONTITWIST	506830	SCOOTSMART	
		465633	S83	495899	CONTICLASSIC			
	3,50 x 10	3634	S83	495901	CONTITWIST	511587	TT93 GP	
		523468	S1	493050	CONTICLASSIC	506831	SCOOTSMART	
				502424	K62/ K62WW			
	4,00 x 10			523515	CONTISCOOT			
	80/90 x 10	523467	S1					
	80/100 x 10	523466	S1					
	90/90 x 10		496352	CITY GRIP	478944	CONTITWIST	506832	SCOOTSMART
			523462	CITY GRIP SAVER				
			3637	S1				
	90/100 x 10			495906	CONTITWIST	506833	SCOOTSMART	
	100/80 x 10		491710	CITY GRIP	478946	CONTITWIST	506834	SCOOTSMART
			3639	S1				
	100/90 x 10		504336	CITY GRIP	478947	CONTITWIST	506835	SCOOTSMART
		363194	S1					
		523464	CITY GRIP					
		506359	S83					
110/80 x 10	122484	S1	478948	CONTITWIST				
120/70x 10	481917	CITY GRIP 2	478949	CONTITWIST	506836	SCOOTSMART		
120/90 x 10		227541	BOPPER	478950	CONTITWIST	506837	SCOOTSMART	
		3642	REGGAE			506858	TRAILMAX	
130/70 x 10	210937	S1	486803	CONTITWIST	506838	SCOOTSMART		
130/90 x 10		227556	BOPPER	478951	CONTITWIST	506839	SCOOTSMART	
		3643	REGGAE			506859	TRAILMAX	
150/80 x 10								
11"	110/70x 11	481920	CITY GRIP 2	478952	CONTITWIST	506824	SCOOTSMART	
	120/70x 11	493104	CITY GRIP 2					
90/90 x 12		523465	CITY GRIP SAVER					
		496353	CITY GRIP					
		518176	CITY GRIP SAVER					
100/80 x 12	518176	CITY GRIP SAVER						
100/90 x 12	496354	CITY GRIP			511588	TT93 GP		
12"	110/70 x 12	506330	CITY GRIP 2	503146	CONTISCOOT	506825	SCOOTSMART	
		484081	POWER PURE SC	486256	CONTITWIST			
		523460	CITY GRIP 2					
		523461	CITY GRIP SAVER					
	110/80 x 12	518179	CITY GRIP SAVER					

DELITIRE		GOODRIDE		obor		HEIDENAU	
Réf.	Modèle	Réf.	Modèle	Réf.	Modèle	Réf.	Modèle
460437	S233						
460425	S239						
460424	S236	514057	H-692				
460426	S224 SPORT						
493603	SCI03						
460428	S224 SPORT						
476727	SCI03						
481416	OPTIMO	514058	H-968				
460431	SCI01	514060	H-686				
460430	S224 SPORT	514059	H-968				
481417	OPTIMO	514061	H-686				
460432	SCI01						
464834	SCI01	519659	H-968				
		519660	H-968				
514038	URBAN GRIP	514064	H-968	513908	S31F	501974	
480575	SCI02						

Pouces	Dimensions						
		Réf.	Modèle	Réf.	Modèle	Réf.	Modèle
12"	110/90 x 12	506334	CITY GRIP 2	495902	CONTITWIST		
		506336	CITY GRIP 2	503147	CONTISCOOT	506840	SCOOTSMART
	120/70 x 12	506337	CITY GRIP 2	503160	CONTISCOOT	506841	SCOOTSMART
		169435	BOPPER	491152	CONTITWIST		
		481143	POWER PURE SC	478953	CONTITWIST		
		523463	CITY GRIP SAVER	523516	CONTISCOOT		
	120/80 x 12	506341	CITY GRIP 2			511589	TT93 GP
						511590	TT93 GP
						511591	TT93 GP
	130/70 x 12	506345	CITY GRIP 2	503161	CONTISCOOT	506842	SCOOTSMART
		169440	BOPPER	478954	CONTITWIST	506843	SCOOTSMART
		493205	POWER PURE SC	523517	CONTISCOOT		
	130/80 x 12						
	140/70 x 12	506351	CITY GRIP 2	495904	CONTITWIST		
481151		POWER PURE SC					
13"	110/70 x 13	506331	CITY GRIP 2	503148	CONTISCOOT	506826	SCOOTSMART
		518178	CITY GRIP SAVER			507053	SCOOTSMART
	110/90 x 13	506335	CITY GRIP 2	503149	CONTISCOOT		
		481142	POWER PURE SC	478955	CONTITWIST		
	120/70 x 13	506338	CITY GRIP 2	503150	CONTISCOOT	506827	SCOOTSMART
		481144	POWER PURE SC				
	130/60 x 13	506344	CITY GRIP 2	478956	CONTITWIST	506844	SCOOTSMART
		481148	POWER PURE SC	523518	CONTISCOOT		
		484030	POWER PURE SC				
	130/70 x 13	506346	CITY GRIP 2	503162	CONTISCOOT	506851	SCOOTSMART
		481150	POWER PURE SC	495905	CONTITWIST		
	140/60 x 13	506349	CITY GRIP 2	503163	CONTISCOOT	506852	SCOOTSMART
		481152	POWER PURE SC	478957	CONTITWIST	506853	SCOOTSMART
	150/70 x 13	465623	POWER PURE SC	503164	CONTISCOOT	511255	SCOOTSMART
506355		CITY GRIP 2					
14"	80/80 x 14						
	80/90 x 14			503151	CONTISCOOT	507054	SCOOTSMART
	90/80 x 14	502493	PILOT STREET			507056	SCOOTSMART
	90/90 x 14	506358	CITY GRIP 2	503152	CONTISCOOT	506845	SCOOTSMART
		493731	PILOT STREET	503165	CONTISCOOT		
	100/70 x 14						
	100/80 x 14	504334	CITY GRIP			507052	SCOOTSMART
		518177	CITY GRIP SAVER				
	100/90 x 14	506329	CITY GRIP 2	503167	CONTISCOOT	511247	SCOOTSMART
	110/70 x 14	515764	CITY GRIP				
	110/80 x 14	506333	CITY GRIP 2	503166	CONTISCOOT	506854	SCOOTSMART
		506339	CITY GRIP 2	503153	CONTISCOOT	506846	SCOOTSMART
	120/70 x 14	499695	CITY GRIP	478958	CONTITWIST	511248	SCOOTSMART
493203		PILOT POWER 3					

DELITIRE		GOODRIDE		obor		HEIDENAU	
Réf.	Modèle	Réf.	Modèle	Réf.	Modèle	Réf.	Modèle
						479646	
491186	URBAN GRIP	514062	H-968				
481414	OPTIMO						
509315	SCI01						
491187	URBAN GRIP	514063	H-968			479647	
481415	OPTIMO						
509316	SCI01						
						502001	
491193	URBAN GRIP						
460436	SCI02	514067	H-968				
491194	URBAN GRIP						
491190	URBAN GRIP	514068	H-968				
461009	SCI02						
491197	URBAN GRIP						
464835	SB 108						
496351	URBAN GRIP						
						495780	
						496054	
						467533	
465684	SB 108						
508886	URBAN GRIP						
		519657	H-968				
496455	URBAN GRIP						
491189	URBAN GRIP						

MOTEUR

CYCLE

PNEUMATIQUE

ATELIER

ACCESSOIRES

ÉLECTRICITÉ

FILTRATION

FREINAGE

TRANSMISSION



Pouces	Dimensions	Réf.	Modèle	Réf.	Modèle	Réf.	Modèle
14"	120/80 x 14	506342	CITY GRIP 2	503154	CONTISCOOT	511249	SCOOTSMART
		481147	POWER PURE SC				
	140/60 x 14	506350	CITY GRIP 2	478959	CONTITWIST	506855	SCOOTSMART
		476700	CITY GRIP				
	140/70 x 14	506352	CITY GRIP 2	503168	CONTISCOOT	506856	SCOOTSMART
				478960	CONTITWIST		
150/70 x 14	506356	CITY GRIP 2	478961	CONTITWIST	511250	SCOOTSMART	
160/60 x 14	493204	PILOT ROAD 4			511251	SCOOTSMART	
15"	120/70 x 15	506340	CITY GRIP 2	503155	CONTISCOOT	506829	SCOOTSMART
		481146	POWER PURE SC	478963	CONTITWIST	506828	SCOOTSMART
		493045	PILOT POWER 3				
		493047	PILOT ROAD 4				
	130/80 x 15	506348	CITY GRIP 2				
		481153	POWER PURE SC				
140/70 x 15	506353	CITY GRIP 2	503169	CONTISCOOT	511254	SCOOTSMART	
160/60 x 15	493046	PILOT POWER 3			506857	SCOOTSMART	
	493048	PILOT ROAD 4					
16"	80/90 x 16					507055	SCOOTSMART
	90/80 x 16	506357	CITY GRIP 2	503156	CONTISCOOT	506847	SCOOTSMART
	90/90 x 16					507057	SCOOTSMART
	100/80 x 16	506328	CITY GRIP 2	503157	CONTISCOOT	506848	SCOOTSMART
	110/70 x 16	506332	CITY GRIP 2	503158	CONTISCOOT	506849	SCOOTSMART
				478964	CONTITWIST		
	120/70 x 16	515916	CITY GRIP 2	503159	CONTISCOOT	511252	SCOOTSMART
						523733	SCOOTSMART
	120/80 x 16	506343	CITY GRIP 2	503170	CONTISCOOT	506850	SCOOTSMART
130/70 x 16	506347	CITY GRIP 2	503171	CONTISCOOT	511253	SCOOTSMART	
140/70 x 16	506354	CITY GRIP 2					
16"+	80/80x16+			478965	CONTITWIST		

DELITIRE		GOODRIDE		obor		HEIDENAU	
Réf.	Modèle	Réf.	Modèle	Réf.	Modèle	Réf.	Modèle
		519654	H-968				
491191	URBAN GRIP						
491188	URBAN GRIP	519655	H-968				
		519656	H-968				
491192	URBAN GRIP						
496453	URBAN GRIP					467534	
491195	URBAN GRIP	519653	H-968				
491198	URBAN GRIP					479358	
						467536	



/ CITY GRIP 2

Les composés à base de silice offrent un très haut niveau d'adhérence sur les surfaces mouillées ou glissantes, y compris les bandes blanches. Le city grip 2 est une Réf. en longévité.

- Bande de roulement avec de nouveaux mélanges à base de silice
- Lamelles uniques en dents de requin pour une sécurité exceptionnelle sur les surfaces mouillées

Pouces	Réf.	Dimensions	Indice de charge et vitesse	Avant/arrières	TL/TT	Standard/Renforcé
10"	481917	120/70 x 10	54L	arrière	TL	renforcé
11"	481920	110/70 x 11	45L	avant	TL	
	493104	120/70 x 11	56L	arrière	TL	
12"	506330	110/70 x 12	47S	avant	TL	
	506334	110/90 x 12	64S	avant/arrière	TL	
	506336	120/70 x 12	51S	avant	TL	
	506337	120/70 x 12	58S	avant/arrière	TL	renforcé
	506341	120/80 x 12	65S	avant/arrière	TL	
	506345	130/70 x 12	62S	avant/arrière	TL	renforcé
	506351	140/70 x 12	65S	arrière	TL	renforcé
13"	523460	110/70 x 12	47S	avant	TL	
	506331	110/70 x 13	48S	avant	TL	
	506335	110/90 x 13	56S	avant	TL	
	506338	120/70 x 13	53S	avant	TL	
	506344	130/60 x 13	60S	avant/arrière	TL	renforcé
	506346	130/70 x 13	63S	avant/arrière	TL	renforcé
	506349	140/60 x 13	63S	arrière	TL	renforcé
14"	506355	150/70 x 13	64S	arrière	TL	
	506329	100/90 x 14	57S	arrière	TL	renforcé
	506333	110/80 x 14	59S	avant/arrière	TL	renforcé
	506339	120/70 x 14	61S	avant/arrière	TL	renforcé
	506342	120/80 x 14	58S	avant/arrière	TL	
	506350	140/60 x 14	64S	arrière	TL	renforcé
	506352	140/70 x 14	68S	arrière	TL	renforcé
	506356	150/70 x 14	66S	arrière	TL	
15"	506358	90/90 x 14	52S	avant/arrière	TL	renforcé
	506340	120/70 x 15	56S	avant	TL	
	506348	130/80 x 15	63S	arrière	TL	
16"	506353	140/70 x 15	69S	arrière	TL	
	506328	100/80 x 16	50S	avant/arrière	TL	renforcé
	506332	110/70 x 16	52S	avant	TL	
	506343	120/80 x 16	60S	avant/arrière	TL	
	506347	130/70 x 16	61S	arrière	TL	
	506354	140/70 x 16	65S	arrière	TL	
	506357	90/80 x 16	51S	avant/arrière	TL	renforcé
	515916	120/70 x 16	57S	avant	TL	



/ CITY GRIP

Les composés à base de silice offrent un très haut niveau d'adhérence sur les surfaces mouillées ou glissantes, y compris les bandes blanches. Le city grip est le choix de confiance des constructeurs de scooter.

- Large couverture dimensionnelle.
- Sécurité optimale sur surface mouillée avec les lamelles signées "MICHELIN Progressive Sipe Technologie".

Pouces	Réf.	Dimensions	Indice de charge et vitesse	Avant/arrières	TL/TT	Standard/ Renforcé
10"	491710	100/80 x 10	53L	avant/arrière	TL	
	496352	90/90 x 10	50J	avant/arrière	TL	
	504336	100/90 x 10	56J	avant/arrière	TL	
12"	496353	90/90 x 12	54P	avant/arrière	TL	
	496354	100/90 x 12	64P	avant/arrière	TL	
14"	476700	140/60 x 14	64P	arrière	TL	renforcé
	499695	120/70 x 14	61P	arrière	TL	renforcé
	504334	100/80 x 14	48P	avant	TL/TT	renforcé
	515764	110/70 x 14	50P	avant	TL	

*DES SILLONS EN FORME DE DENTS DE REQUIN AMÉLIORE LE GRIP SUR SOL MOUILLÉ ET OFFRE UNE DISTANCE DE FREINAGE **SUR SOL MOUILLÉ** EXCEPTIONNELLE.*

*LE COMPOSÉ À BASE DE SILICE ET LES RAINURES DIRECTIONNELLES ÉVACUENT L'EAU LOIN DE LA ZONE DE CONTACT, ASSURANT UN CONTRÔLE PARFAIT **SUR LE SEC COMME SUR LE MOUILLÉ.***

CE N'EST PAS UNE ÉVOLUTION, C'EST UNE RÉVOLUTION MICHELIN !

MICHELIN CITY GRIP 2

SÉCURITÉ SUR SOL SEC OU MOUILLÉ POUR UN USAGE ROUTE OU URBAIN.

MICHELIN

www.michelin.fr

Informations correctes à date de publication - 09/2023 - MFP
Michelin 855 200 507 CLERMONT-FERRAND. Société en commandite par actions au capital de 504.000.004€.
Maxibrand - RCS 450 580 253 - Photo credit: ©Michelin.



/ CITY GRIP SAVER

Pouces	Réf.	Dimensions	Indice de charge et vitesse	Avant/arrières	TL/TT	Standard/Renforcé
10"	523462	90/90 x 10	50J		TL	
	523464	100/90 x 10	61J		TL/TT	
12"	523461	110/70 x 12	47S		TL	
	523463	120/70 x 12	58S		TL	renforcé
	523465	90/90 x 10	54S		TL/TT	
	518176	100/80 x 12	56P	avant	TL	
	518179	110/80 x 12	61P	arriere	TL	
13"	518178	110/70 x 13	54S		TL	
14"	518177	100/80 x 14	48S		TL	



/ BOPPER

Le pneu aux performances essentielles au look sportif pour votre scooter.

- Un pneu polyvalent assurant un bon niveau de grip avec un look sportif pour votre scooter.
- Un dessin semi-slick pour des performances étonnantes : mise sur l'angle et adhérence maximales.

Pouces	Réf.	Dimensions	Indice de charge et vitesse	Avant/arrières	TL/TT	Standard/Renforcé
10"	227541	120/90 x 10	57L	avant/arrière	TL/TT	
	227556	130/90 x 10	61L	avant/arrière	TL/TT	
12"	169435	120/70 x 12	51L	avant/arrière	TL/TT	
	169440	130/70 x 12	56L	avant/arrière	TL/TT	



/ REGGAE

Le pneu on-off road au look baroudeur pour votre scooter.

- Adapté à tous les terrains avec sa sculpture à crampons.
- Un look fun et original pour votre scooter.

Pouces	Réf.	Dimensions	Indice de charge et vitesse	Avant/arrières	TL/TT	Standard/Renforcé
10"	3642	120/90 x 10	57J	avant/arrière	TL	
	3643	130/90 x 10	61J	avant/arrière	TL	



/ S1

Le pneu aux performances essentielles pour votre scooter.

- Un pneu polyvalent assurant un bon niveau de grip avec un look élégant pour votre scooter.
- Grâce à sa bande de roulement optimisée et à sa sculpture, il garantit un grip exceptionnel, une bonne maniabilité et une longévité accrue.

Pouces	Réf.	Dimensions	Indice de charge et vitesse	Avant/arrières	TL/TT	Standard/ Renforcé
10"	122484	110/80 x 10	58J	avant/arrière	TL/TT	
	210937	130/70 x 10	62J	avant/arrière	TL/TT	
	363194	100/90 x 10	56J	avant/arrière	TL/TT	
	3637	90/90 x 10	50J	avant/arrière	TL/TT	
	3639	100/80 x 10	53L	avant/arrière	TL/TT	
	493211	3,00 x 10	50J	avant/arrière	TL/TT	
	523466	80/100 x 10	46J		TL/TT	
	523467	80/90 x 10	44J		TL/TT	
	523468	3,50 x 10	59J		TL/TT	renforcé



/ S83

Design adapté pour votre scooter au look rétro.

- Sécurité et adhérence adaptées aux scooters rétros les plus mythiques, en roues de 8ou 10 pouces.
- La haute performance de son grip est particulièrement adaptée aux conditions urbaines extrêmes.
- Le pneu choisi par Vespa en première monte de ses modèles les plus rétro, les Vespa PX125 et 150.

Pouces	Réf.	Dimensions	Indice de charge et vitesse	Avant/arrières	TL/TT	Standard/ Renforcé
8"	320344	3,50 x 8	46J	avant/arrière	TT	
10"	3634	3,50 x 10	59J	avant/arrière	TL/TT	renforcé
	465633	3,00 x 10	42J	avant/arrière	TL/TT	



/ POWER PURE SC

Grip et sportivité pour votre scooter en usage urbain.

- Plus de grip avec la technologie bi-gomme MICHELIN " Dual Compound Technology " 2CT.
- Plus de longévité grâce à sa sculpture optimisée.

Pouces	Réf.	Dimensions	Indice de charge et vitesse	Avant/arrières	TL/TT	Standard/ Renforcé
12"	481143	120/70 x 12	51P	avant/arrière	TL	
	481151	140/70 x 12	60P	arrière	TL	
	484081	110/70 x 12	47L	avant	TL	
	493205	130/70 x 12	62P	arrière	TL	renforcé
13"	465623	150/70 x 13	64S	arrière	TL	
	481142	110/90 x 13	56P	avant	TL	
	481144	120/70 x 13	53P	avant	TL	
	481148	130/60 x 13	53P	avant/arrière	TL	
	481150	130/70 x 13	63P	arrière	TL	renforcé
	481152	140/60 x 13	57P	arrière	TL	
	484030	130/60 x 13	60P	avant/arrière	TL	renforcé
14"	481147	120/80 x 14	58S	avant	TL	
15"	481146	120/70 x 15	56S	avant	TL	
	481153	130/80 x 15	63P	arrière	TL	



/ PILOT POWER 3

Sécurité et sportivité pour votre maxi-scooter sur route sèche et mouillée

- Grip et stabilité grâce à la technologie bi-gomme MICHELIN " Dual Coumpound Technology " 2CT.
- Une structure radiale qui renforce la maniabilité et stabilité des Maxi-Scooters les plus puissants.
- Grâce à la technologie Michelin 2CT, le pneu MICHELIN Pilot Power • SC est conçu pour une longévité améliorée.

Pouces	Réf.	Dimensions	Indice de charge et vitesse	Avant/arrières	TL/TT	Standard/ Renforcé
14"	493203	120/70 x 14	55H	avant	TL	
15"	493045	120/70 x 15	56H	avant	TL	
	493046	160/60 x 15	67H	arrière	TL	



/ PILOT ROAD 4

Sécurité et maniabilité pour votre maxi-scooter sur route sèche et mouillée.

- Bon niveau de grip sur route sèche et mouillée grâce à l'alliance de la technologie MICHELIN " X Sipe Technology + " et d'un mélange de gommages à base de silice.
- Une structure radiale qui renforce la maniabilité et stabilité des Maxi-Scooters les plus puissants.
- Une longévité améliorée grâce à la technologie Michelin 2CT.

Pouces	Réf.	Dimensions	Indice de charge et vitesse	Avant/arrières	TL/TT	Standard/ Renforcé
14"	493204	160/60 x 14	65H	arrière	TL	
15"	493047	120/70 x 15	56H	avant	TL	
	493048	160/60 x 15	67H	arrière	TL	



/ PILOT STREET

Le pneu polyvalent pour votre usage urbain et quotidien.

- Une bande de roulement sillons favorisant l'évacuation de l'eau et offrant une bonne adhérence sur route mouillée.
- Equilibre, adhérence et usure optimisés grâce à un design inspiré des pneus MICHELIN pour motos sportives.

Pouces	Réf.	Dimensions	Indice de charge et vitesse	Avant/arrières	TL/TT	Standard/ Renforcé
14"	502493	90/80 x 14	49P	avant/arrière	TL	renforcé
	493731	90/90 x 14	52P	avant/arrière	TL/TT	renforcé



/ ACS

Design adapté pour votre scooter au look rétro

- Le pneu MICHELIN ACS est conçu spécifiquement pour les scooters citadins de 9 pouces.

Pouces	Réf.	Dimensions	Indice de charge et vitesse	Avant/arrières	TL/TT	Standard/ Renforcé
9"	320363	2,75 x 9	35J	avant/arrière	TT	



/ CROSS CLIMAT - AGREE LA POSTE

Pouces	Réf.	Dimensions	Indice de charge et vitesse	Avant/arrières	TL/TT	Standard/ Renforcé
13"	519626	145/60 x13	66T		TL	

/ CONTISCOOT

Le pneu scooter Premium avec l'ADN d'un champion aux tests.

- Le meilleur grip du marché sur le mouillé parmi les pneus premium scooter. Un excellent drainage et un composant optimisé pour un grip maximal.
- Courte distance de freinage.
- Pneu scooter agile pour une maniabilité inégalée dans le trafic urbain.
- Haut kilométrage avec une usure uniforme qui procure une haute performance durant toute sa durée de vie.



Pouces	Réf.	Dimensions	Indice de charge et vitesse	Avant/arrières	TL/TT	Standard/ Renforcé
10"	523515	3,50 x 10	59L		TL	renforcé
12"	503146	110/70 x 12	47P	avant	TL	
	503147	120/70 x 12	51P	avant	TL	
	503160	120/70 x 12	58P	arrière	TL	renforcé
	503161	130/70 x 12	62P	arrière	TL	renforcé
	523516	120/70 x 12	58P		TL	renforcé
	523517	130/70 x 12	62P		TL	renforcé
13"	503148	110/70 x 13	48S	avant	TL	
	503149	110/90 x 13	56P	avant	TL	
	503150	120/70 x 13	53P	avant	TL	
	503162	130/70 x 13	63P	arrière	TL	renforcé
	503163	140/60 x 13	63P	arrière	TL	renforcé
	503164	150/70 x 13	64S	arrière	TL	
	523518	130/60 x 13	63P			
14"	503151	80/90 x 14	40P	avant	TL	
	503152	90/90 x 14	46P	avant	TL	
	503153	120/70 x 14	55P	avant	TL	
	503154	120/80 x 14	58S	avant	TL	
	503165	90/90 x 14	52P	arrière	TL	renforcé
	503166	110/80 x 14	59P	arrière	TL	renforcé
	503167	100/90 x 14	57P	arrière	TL	renforcé
	503168	140/70 x 14	68S	arrière	TL	renforcé
15"	503155	120/70 x 15	56S	avant	TL	
	503169	140/70 x 15	69P	arrière	TL	renforcé
16"	503156	90/80 x 16	51P	avant	TL	renforcé
	503157	100/80 x 16	50P	avant	TL	
	503158	110/70 x 16	52S	avant	TL	
	503159	120/70 x 16	57P	avant	TL	
	503170	120/80 x 16	60P	arrière	TL	
	503171	130/70 x 16	61S	arrière	TL	

Continental
 The Future in Motion

/ CONTITWIST

Le pneu polyvalent moderne pour la ville et la campagne.

- Un mélange innovant pour un kilométrage élevé, combine à une excellente adhérence sur route sèche et mouillée.
- Excellente stabilité et tenue de route très précise.
- De nouvelles carcasses, développées pour convenir même à des scooters de grande puissance.
- Profil de bande de roulement avec de nouveaux bords pour un super look.

Pouces	Réf.	Dimensions	Indice de charge et vitesse	Avant/arrières	TL/TT	Standard/ Renforcé
10"	478944	90/90 x 10	50M	avant/arrière	TL	
	478946	100/80 x 10	58M	avant/arrière	TL	
	478947	100/90 x 10	56M	avant/arrière	TL	
	478948	110/80 x 10	63L	avant/arrière	TL	renforcé
	478949	120/70 x 10	54L	avant/arrière	TL	
	478950	120/90 x 10	57J	avant/arrière	TL	
	478951	130/90 x 10	61J	avant/arrière	TL	
	486803	130/70 x 10	59M	avant/arrière	TL	
	495900	3,00 x 10	50M	avant/arrière	TL	
	495901	3,50 x 10	59M	avant/arrière	TL	
11"	495906	90/100 x 10	53J	avant/arrière	TL	
	478952	110/70 x 11	45M	avant/arrière	TL	
12"	478953	120/70 x 12	58P	avant/arrière	TL	renforcé
	478954	130/70 x 12	62P	avant/arrière	TL	renforcé
	486256	110/70 x 12	47L	avant/arrière	TL	
	491152	120/70 x 12	58P	avant/arrière	TL	Flancs blancs renforcé
	495902	110/90 x 12	64P	avant/arrière	TL	
	495904	140/70 x 12	65P	avant/arrière	TL	renforcé
13"	478955	110/90 x 13	56Q	avant/arrière	TL	
	478956	130/60 x 13	53P	arrière	TL	
	478957	140/60 x 13	63S	arrière	TL	
	495905	130/70 x 13	63Q	avant/arrière	TL	
14"	478958	120/70 x 14	55S	avant	TL	
	478959	140/60 x 14	64S	avant/arrière	TL	renforcé
	478960	140/70 x 14	68S	arrière	TL	
	478961	150/70 x 14	66S	arrière	TL	
15"	478963	120/70 x 15	56S	avant	TL	
16"	478964	110/70 x 16	52S	avant	TL	
	478965	140/70 x 16	65S	arrière	TL	

Continental
 The Future in Motion

/ CONTICLASSIC

- Conception classique du profil alliée à un mélange moderne.
- Structure de la carcasse axée sur le confort.
- Kilométrage élevé pour une utilisation au quotidien.

Pouces	Réf.	Dimensions	Indice de charge et vitesse	Avant/arrières	TL/TT	Standard/ Renforcé
10"	493050	3,50 x 10	59L	avant/arrière	TT	
	495899	3,00 x 10	50J	avant/arrière	TT	

/ K62/ K62 WW

Le pneu classique pour l'amateur de scooters rétro.

- Des pavés ouverts avec des lamelles pour de bonnes performances, même par mauvais temps.
- Très durable grâce à son mélange innovant et à ses sculptures profondes.
- Une construction renforcée assure une très grande capacité de charge.



Pouces	Réf.	Dimensions	Indice de charge et vitesse	Avant/arrières	TL/TT	Standard/ Renforcé
10"	500635	4,00 x 10	60J	avant/arrière	TT	
	502424	3,50 x 10	59J	avant/arrière	TL	flancs blancs, renforcé

/ TT93 GP

Pneumatique Scooter de compétition et homologué sur route.

- La sculpture semi-slick de la bande de roulement et la rigidité spéciale du mélange de gomme permettent de bénéficier d'une réactivité instantanée.
- Offre une adhérence encore améliorée par rapport au TT92 GP qu'il remplace.
- La rigidité du mélange de gomme est optimisée pour une réactivité instantanée.



Pouces	Réf.	Dimensions	Indice de charge et vitesse	Avant/arrières	TL/TT	Standard/ Renforcé
10"	511587	3,50 x 10	51J	avant/arrière	TL	
12"	511588	100/90 x 12	49J	avant	TL	
	511589	120/80 x 12	55J	arrière	TL	medium
	511590	120/80 x 12	55J	arrière	TL	medium soft
	511591	120/80 x 12	55J	arrière	TL	soft

/ TRAILMAX

Pneumatique Scooter pour un usage route ou chemin.

- Sculpture de bande mixte agressive.
- Blocs auto-nettoyants de la bande de roulement pour une remarquable adhérence sur route et en tout-terrain.



Pouces	Réf.	Dimensions	Indice de charge et vitesse	Avant/arrières	TL/TT	Standard/ Renforcé
10"	506858	120/90 x 10	57J	avant	TL	
	506859	130/90 x 10	61J	arrière	TL	



/ SCOOTSMART

Directement développés à partir des pneus moto, la gamme est adaptée à tous les types de scooter.

- Mélange à base de silice offrant une longévité accrue et d'excellentes performances, quelles que soient les conditions.
- Sculpture de bande directement dérivée du RoadSmart maintes fois primé lors des tests.
- Garantit un niveau élevé d'adhérence et un comportement neutre jusqu'à 210 km/h

Pouces	Réf.	Dimensions	Indice de charge et vitesse	Avant/arrières	TL/TT	Standard/ Renforcé
10"	506830	3,00 x 10	42J	avant/arrière	TL	
	506831	3,50 x 10	59J	avant/arrière	TL	
	506832	90/90 x 10	50J	avant/arrière	TL	
	506833	90/100 x 10	53J	avant/arrière	TL	
	506834	100/80 x 10	53L	avant/arrière	TL	
	506835	100/90 x 10	56J	avant/arrière	TL	
	506836	120/70 x 10	54L	avant/arrière	TL	
	506837	120/90 x 10	57L	avant/arrière	TL	
	506838	130/70 x 10	62J	avant/arrière	TL	
11"	506839	130/90 x 10	61L	avant/arrière	TL	
	506824	110/70 x 11	45L	avant	TL	
12"	506825	110/70 x 12	47L	avant	TL	
	506840	120/70 x 12	51S	avant/arrière	TL	
	506841	120/70 x 12	58P	avant/arrière	TL	
	506842	130/70 x 12	56P	avant/arrière	TL	
	506843	130/70 x 12	62S	avant/arrière	TL	
13"	506826	110/70 x 13	48P	avant	TL	
	506827	120/70 x 13	53P	avant	TL	
	506844	130/60 x 13	60P	avant/arrière	TL	
	506851	130/70 x 13	63P	arrière	TL	
	506852	140/60 x 13	57P	arrière	TL	
	506853	140/60 x 13	63S	arrière	TL	
	507053	110/70 x 13	54S	avant/arrière	TL	
511255	150/70 x 13	64S	arrière	TL		
14"	506845	90/90 x 14	46P	avant/arrière	TL	
	506846	120/70 x 14	S	avant/arrière	TL	
	506854	110/80 x 14	59S	avant/arrière	TL	
	506855	140/60 x 14	64S	arrière	TL	
	506856	140/70 x 14	68S	arrière	TL	
	507052	100/80 x 14	54P	avant/arrière	TL	
	507054	80/90 x 14	46P	avant/arrière	TL	
	507056	90/80 x 14	49P	avant/arrière	TL	
	511247	100/90 x 14	57P	avant/arrière	TL	
	511248	120/70 x 14	61P	arrière	TL	
	511249	120/80 x 14	58S	avant/arrière	TL	
	511250	150/70 x 14	66S	arrière	TL	
	511251	160/60 x 14	65H	arrière	TL	
	15"	506828	120/70 x 15	56S	avant	TL
506829		120/70 x 15	56H	avant	TL	
506857		160/60 x 15	67H	arrière	TL	
511254		140/70 x 15	69S	arrière	TL	
16"	506847	90/80 x 16	51P	avant/arrière	TL	
	506848	100/80 x 16	50P	avant/arrière	TL	
	506849	110/70 x 16	52S	avant/arrière	TL	
	506850	120/80 x 16	60P	avant/arrière	TL	
	507055	80/90 x 16	48P	avant/arrière	TL	
	507057	90/90 x 16	48P	avant/arrière	TL	
	511252	120/70 x 16	57S	avant	TL	
	511253	130/70 x 16	61S	arrière	TL	
	523733	120/70 x R16	57H	avant	TL	

DELI TIRE



/ URBAN GRIP

Pouces	Réf.	Dimensions	Indice de charge et vitesse	Avant/arrières	TL/TT	Standard/ Renforcé
12"	491186	120/70 x 12	58S	avant	TL	renforcé
	491187	130/70 x 12	62P	arrière	TL	renforcé
	491200	110/90 x 12	64P	arrière	TL	
	514038	110/70 x 12	47L		TL	
13"	491190	140/60 x 13	63P	arrière	TL	renforcé
	491194	130/70 x 13	63P	arrière	TL	renforcé
	491197	150/70 x 13	64S	arrière	TL	
	491193	110/90 x 13	56P	avant	TL	
14"	491188	140/70 x 14	68S	arrière	TL	renforcé
	491189	120/70 x 14	55S	avant	TL	
	491191	140/60 x 14	64S	arrière	TL	renforcé
	496351	80/90 x 14	46P	avant/arrière	TL	renforcé
	496455	110/80 x 14	59S	arrière	TL	renforcé
	508886	100/80 x 14	48P	arrière	TL	renforcé
15"	491192	120/70 x 15	56S	avant	TL	
	491195	100/80 x 16	50P	avant	TL	
16"	491198	110/70 x 16	52P	avant	TL	
	496453	90/80 x 16	51S		TL	renforcé

DELI TIRE



/ S224 SPORT

Pouces	Réf.	Dimensions	Indice de charge et vitesse	Avant/arrières	TL/TT	Standard/ Renforcé
10"	460426	90/90 x 10	50J	avant/arrière	TL/TT	
	460428	120/70 x 10	54L	avant/arrière	TL	
	460430	130/90 x 10	70J	avant/arrière	TL	

DELI TIRE



/ OPTIMO

Pouces	Réf.	Dimensions	Indice de charge et vitesse	Avant/arrières	TL/TT	Standard/ Renforcé
10"	481416	120/90 x 10	66J	avant/arrière	TL	renforcé
	481417	130/90 x 10	70J	avant/arrière	TL	renforcé
12"	481414	120/70 x 12	51L	avant/arrière	TL	renforcé
	481415	130/70 x 12	56L	avant/arrière	TL	renforcé

DELITIRE



/ SC102

Pouces	Réf.	Dimensions	Indice de charge et vitesse	Avant/arrières	TL/TT	Standard/ Renforcé
12"	480575	110/70 x 12	47L	avant/arrière	TL	
13"	460436	130/60 x 13	60M	avant/arrière	TL	renforcé
	461009	140/60 x 13	57P	avant/arrière	TL	

DELITIRE



/ SC101

Pouces	Réf.	Dimensions	Indice de charge et vitesse	Avant/arrières	TL/TT	Standard/ Renforcé
10"	460431	120/90 x 10	66J	avant/arrière	TL	renforcé
	460432	130/90 x 10	70J	avant/arrière	TL	renforcé
	464834	150/80 x 10	65L	avant/arrière	TL	renforcé
12"	509316	130/70 x 12	61P	arrière	TL	renforcé
	509315	120/70 x 12	58P	avant	TL	

DELITIRE



/ SC103

Pouces	Réf.	Dimensions	Indice de charge et vitesse	Avant/arrières	TL/TT	Standard/ Renforcé
10"	476727	100/70 x 10	54L	avant/arrière	TL	renforcé
	493603	100/80 x 10	53L	avant/arrière	TL	

DELITIRE



/ SC108

Pouces	Réf.	Dimensions	Indice de charge et vitesse	Avant/arrières	TL/TT	Standard/ Renforcé
14"	464835	80/80 x 14	53L	avant/arrière	TL/TT	renforcé
	465684	100/70 x 14	53L	avant/arrière	TL/TT	renforcé

DELITIRE



/ S233

Pouces	Réf.	Dimensions	Indice de charge et vitesse	Avant/arrières	TL/TT	Standard/ Renforcé
8"	460437	4,00 x 8	62M	avant/arrière	TT	

DELITIRE



/ S236

Pouces	Réf.	Dimensions	Indice de charge et vitesse	Avant/arrières	TL/TT	Standard/ Renforcé
10"	460424	3,50 x 10	51J	avant/arrière	TL	

DELITIRE



/ S239

Pouces	Réf.	Dimensions	Indice de charge et vitesse	Avant/arrières	TL/TT	Standard/ Renforcé
10"	460425	3,00 x 10	42J	avant/arrière	TL	

GOODRIDE.



/ H-686

Pouces	Réf.	Dimensions	Indice de charge et vitesse	Avant/arrières	TL/TT	Standard/ Renforcé
10"	514060	120/90 x 10	66N	avant	TL	
	514061	130/90 x 10	70M	arrière	TL	

GOODRIDE.

/ H-968

Pouces	Réf.	Dimensions	Indice de charge et vitesse	Avant/arrières	TL/TT	Standard/Renforcé
10"	514058	120/90 x 10	57N	avant	TL	
	514059	130/90 x 10	61N	arrière	TL	
11"	519659	110/70 x 11	45L		TL	
	519660	120/70 x 11	56L		TL	
12"	514062	120/70 x 12	58P	avant	TL	
	514063	130/70 x 12	62P	arrière	TL	
	514064	110/70 x 12	47P	avant	TL	
13"	514067	130/60 x 13	60P	avant/ arrière	TL	
	514068	140/60 x 13	63P	arrière	TL	
14"	519654	120/80 x 14	58S		TL	
	519655	140/70 x 14	68S		TL	
	519656	150/70 x 14	66S		TL	
	519657	100/90 x 14	57P		TL	
15"	519653	110/70 x 16	52S	avant	TL	

GOODRIDE.

/ H-692

Pouces	Réf.	Dimensions	Indice de charge et vitesse	Avant/arrières	TL/TT	Standard/Renforcé
10"	514057	3,50 x 10	51J	avant/ arrière	TL	

HEIDENAU

/ K58

Pouces	Réf.	Dimensions	Indice de charge et vitesse	Avant/arrières	TL/TT	Standard/Renforcé
12"	501974	110/70 x 12	56M		TL	

HEIDENAU



/ K62

Pouces	Réf.	Dimensions	Indice de charge et vitesse	Avant/arrières	TL/TT	Standard/ Renforcé
12"	502001	130/80 x 12	69M		TL	

HEIDENAU



/ K66

- une bande de roulement composée de gomme au silice et de fibres de textiles spéciales
- une adhérence garantie dans les climats froids et humides
- une sculpture permettant un Excellent drainage

Pouces	Réf.	Dimensions	Indice de charge et vitesse	Avant/arrières	TL/TT	Standard/ Renforcé
12"	479646	120/70 x 12	58S		TL	
	479647	130/70 x 12	62P		TL	
14"	467532	80/80 x 14	43J		TL	
	495780	90/90 x 14	52P		TL	
	496054	90/90 x 14	52P		TL	
	467533	100/70 x 14	50J		TL	
16"	467536	80/80 x 16	46J		TL	
	467534	90/80 x 16	52J		TL	
	479358	110/70 x 16	52S		TL	

abor



/ S31F

Pouces	Réf.	Dimensions	Indice de charge et vitesse	Avant/arrières	TL/TT	Standard/ Renforcé
12"	513908	110/70 x 12	47P	avant	TL	

Pouces	Dimensions	MICHELIN		Continental <small>The Future in Motion</small>		DUNLOP		
		Réf.	Modèle	Réf.	Modèle	Réf.	Modèle	
10"	60/80 x 10					511580	GEOMAX MX33	
	70/10 x 10					511584	GEOMAX MX33	
	2.50 x 10							
12"	60/100 x 12					511581	GEOMAX MX33	
	80/100 x 12					511585	GEOMAX MX33	
14"	60/100 x 14					511582	GEOMAX MX33	
	90/90 x 14	496355	CITY PRO					
	90/100 x 14					511586	GEOMAX MX33	
16"	70/80 x 16	518166	CITY EXTRA					
	70/90 x 16					506818	D110	
	80/90 x 16					506819	D110	
	90/80 x 16	510647	CITY PRO					
	100/80 x 16	518169	CITY EXTRA					
	110/90 x 16					518387	ARROWMAX STREETSMART	
	120/80 x 16					518389	ARROWMAX STREETSMART	
	130/90 x 16			504723	CONTIGO!	518394	ARROWMAX STREETSMART	
	4.60 x 16					518406	K82	
	17"	70/90 x 17	518164	CITY EXTRA	523499	CONTISTREET	523841	SX Q-LITE
		514084	PILOT STREET					
70/100 x 17						511593	GEOMAX MX33	
80/90 x 17				523504	CONTISTREET	523482	SX Q-LITE	
		518165	CITY EXTRA	506386	CONTICITY	523483	SX Q-LITE	
90/80 x 17				523500	CONTISTREET	506813	D102	
90/90 x 17				506387	CONTICITY			
100/80 x 17			451925	PILOT STREET	481328	CONTITWIST SPORT SM	518380	ARROWMAX STREETSMART
					524173	CONTIROAD	506820	TT900
							523474	SX Q-LITE
							523475	SX Q-LITE
100/90 x 17		518170	CITY EXTRA	523505	CONTISTREET			
110/70 x 17				487066	CONTIMOTION	518383	ARROWMAX STREETSMART	
				524174	CONTIROAD	506822	TT900 GP	
				524175	CONTIROAD	523476	SX Q-LITE	
110/80 x 17						518384	ARROWMAX STREETSMART	
						518385	ARROWMAX STREETSMART	
120/60 x 17			487067	CONTIMOTION	518407	ROADSMART II		
120/70 x 17				503769	CONTI SPORTATTACK2	518377	QUALIFIER CORE	
				503772	CONTI SPORTATTACK	518408	ROADSMART II	
				523506	CONTISTREET	523477	SX Q-LITE	

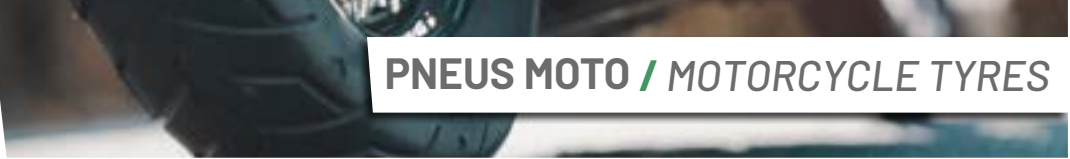

DELITIRE		obor		HEIDENAU	
Réf.	Modèle	Réf.	Modèle	Réf.	Modèle
				479646	K66
483845	SB114				
468387	SB114				
468386	SB114				
460440	SB101				
460438	SB106	513909	SR30		
483484	SB128 SAMURAI				
520847	SB151				
484257	SB128 SAMOURAI				

MOTEUR
CYCLE
PNEUMATIQUE
ATELIER
ACCESSOIRES
ÉLECTRICITÉ
FILTRATION
FREINAGE
TRANSMISSION

Pouces	Dimensions	MICHELIN		Continental <small>The Future in Motion</small>		DUNLOP	
		Réf.	Modèle	Réf.	Modèle	Réf.	Modèle
17"	120/70 x 17			487068	CONTIMOTION		
		524189	TKC 70	524176	CONTIROAD		
				524189	TKC 70		
				524210	TKC 80		
	120/90 x 17	524196	TKC 70				
		524215	TKC 80				
	130/70 x 17	523459	PILOT STREET RADIAL	481329	CONTITWIST SPORT SM	518391	ARROWMAX STREETSMART
				524177	CONTIROAD	506821	TT900
						506814	D102
	130/80 x 17					523478	D102
				486805	CONTIGO!	518392	ARROWMAX STREETSMART
				524197	TKC 70		
				524205	TKC 70		
	130/90 x 17						
						518395	ARROWMAX STREETSMART
	140/70 x 17			524178	CONTIROAD	506823	TT900 GP
				524179	CONTIROAD	523479	SX Q-LITE
				524187	CONTIMOTION		
	140/80 x 17			524198	TKC 70	518396	ARROWMAX STREETSMART
				524206	TKC 70		
			524219	TKC 80			
150/60 x 17			524187	CONTIMOTION	523480	SX Q-LITE	
			524180	CONTIROAD			
			524207	TKC 70			
150/70 x 17			487069	CONTIMOTION	518397	ARROWMAX STREETSMART	
			524181	CONTIROAD			
			524199	TKC 70			
			524220	TKC 80			
160/60 x 17			503770	CONTI SPORTATTACK2	518378	QUALIFIER CORE	
			487070	CONTIMOTION	518410	ROADSMART II	
			524182	CONTIROAD			
			524200	TKC 70			
160/70 x 17					518398	ARROWMAX STREETSMART	
			506383	TKC 80	518412	ROADSMART II	
170/60 x 17			524188	CONTIMOTION			
			524207	TKC 70			
			524208	TKC 70			
180/55 x 17			503771	CONTI SPORTATTACK2	518413	ROADSMART II	

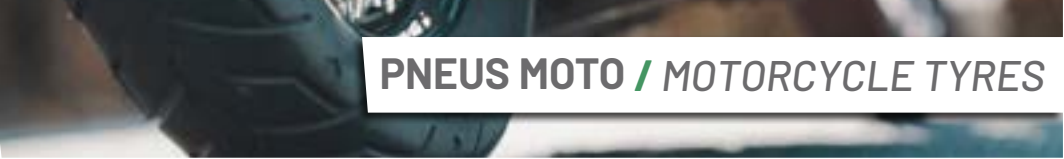

DELITIRE		obor		HEIDENAU	
Réf.	Modèle	Réf.	Modèle	Réf.	Modèle
460441	SB106	513910	SR30		
483483	SB128SAMURAI				
520848	SB151				
520849	SB151				

MOTEUR
CYCLE
PNEUMATIQUE
ATELIER
ACCESSOIRES
ÉLECTRICITÉ
FILTRATION
FREINAGE
TRANSMISSION

Pouces	Dimensions	MICHELIN		Continental <small>The Future in Motion</small>		DUNLOP		
		Réf.	Modèle	Réf.	Modèle	Réf.	Modèle	
17"	180/55 x 17			503773	CONTI SPORTATTACK	518379	QUALIFIER CORE	
				487072	CONTIMOTION			
				524183	CONTIROAD			
				524202	TKC 70			
				524221	TKC 80			
		190/50 x 17			487073	CONTIMOTION	518414	ROADSMART II
		190/55 x 17	524185		524184	CONTIROAD		
		2.50 x 17			523512	CONTISTREET	506815	D104
							506816	D104
								506811
		2.75 x 17			523513	CONTISTREET	506817	D104
		3.00 x 17			523503	CONTISTREET		
					506385	CONTICITY		
		5.10 x 17			524218	TKC 80		
18"	80/90 x 18			523502	CONTISTREET			
	80/100 x 18			523508	CONTISTREET			
	90/90 x 18			523509	CONTISTREET			
		518168	CITY EXTRA	486977	CONTIGO!			
	100/80 x 18			523510	CONTISTREET			
	100/90 x 18			523511	CONTISTREET			
				486804	CONTIGO!	518381	ARROWMAX STREETSMART	
	110/80 x 18			483112	TKC 80	518386	ARROWMAX STREETSMART	
				524190	TKC 70			
	110/90 x 18			480229	CONTIGO!	518388	ARROWMAX STREETSMART	
	120/70 x 18					518409	ROADSMART II	
	120/90 x 18			524225	TKC 80	518390	ARROWMAX STREETSMART	
	130/80 x 18					518393	ARROWMAX STREETSMART	
	140/80 x 18			524226	TKC 80			
	150/70 x 18				524204	TKC 70		
					524209	TKC 70		
					524227	TKC 80		
					524228	TKC 80		
160/60 x 18					518411	ROADSMART II		
2.50 x 18				523514	CONTISTREET			
				523501	CONTISTREET			
2.75 x 18				486976	CONTIGO!	518402	K82	
				506384	CONTICITY			

DELITIRE		obor		HEIDENAU	
Réf.	Modèle	Réf.	Modèle	Réf.	Modèle
479677	SB117				
461004	SB107				

Pouces	Dimensions							
		Réf.	Modèle	Réf.	Modèle	Réf.	Modèle	
18"	3.00 x 18	510657	CITY PRO	523507	CONTISTREET	518403	K82	
	3.25 x 18			524222		518404	K82	
	3.50 x 18			524223	TKC 80	518405	K82	
	4.00 x 18			524203	TKC 70	518400	ARROWMAX STREETSMART	
					524224	TKC 80		
	4.10 x 18			504724	TKC 80			
				490433	CONTI ESCAPE			
19"	70/100 x 19					519395	GEOMAX MX33	
	90/90 x 19					518401	ARROWMAX STREETSMART	
	100/80 x 19			524192	TKC 70			
	100/90 x 19			524211	TKC 80	518382	ARROWMAX STREETSMART	
					524191	TKC 70	516671	GEOMAX MX34
	110/80 x 19			504849	TKC 80	526224	GEOMAX MX33	
	120/70 x 19			506382	TKC 80			
					524193	TKC 70		
	3.25 x 19					518399	ARROWMAX STREETSMART	
					483746	TKC 80		
21"	80/90 x 21			526225	GEOMAX MX34			
	80/100 x 21			524195	TKC 70			
	90/90 x 21			524214	TKC 80			
					504725	TKC 80		
	2.50 x 21			524212	TKC 80			
	2.75 x 21			504726	TKC 80			
					490432	CONTI ESCAPE		
	3.00 x 21			524194	TKC 70			
				524213	TKC 80			

DELITIRE		obor		HEIDENAU	
Réf.	Modèle	Réf.	Modèle	Réf.	Modèle
		524142	TT		
461005	SB107				
478583	SB117				
480312	SB120				



/ CITY EXTRA

- Robuste et résistant
- Durable
- Excellent grip sur sol mouillé

Pouces	Réf.	Dimensions	Indice de charge et vitesse	Avant/arrières	TL/TT	Standard/Renforcé
16"	518166	90/80 x 16	51S	avant/arrière	TL	renforcé
	518169	100/80 x 16	50S	avant/arrière	TL	
17"	518164	70/90 x 17	43S	avant/arrière	TL	renforcé
	518165	80/90 x 17	50S	avant/arrière	TL	renforcé
	518170	100/90 x 17	55S	arrière	TL	
18"	518168	90/90 x 18	57S	avant/arrière	TL	renforcé



/ CITY PRO

- Résistant à la crevaison
- Des performances faites pour durer

Pouces	Réf.	Dimensions	Indice de charge et vitesse	Avant/arrières	TL/TT	Standard/Renforcé
14"	496355	90/90 x 14	52P	avant/arrière	TT	renforcé
16"	510647	90/80 x 16	51S	avant/arrière	TL	
18"	510657	3,00 x 18	52S	avant/arrière	TT	renforcé



/ PILOT STREET

- Grip en conditions humides même en temps de pluie
- Des performances faites pour durer

Pouces	Réf.	Dimensions	Indice de charge et vitesse	Avant/arrières	TL/TT	Standard/Renforcé
14"	493731	90/90 x 14	52P	avant/arrière	TL/TT	renforcé
17"	451925	100/80 x 17	52S	avant	TL/TT	
	514084	70/90 x 17	43S	avant/arrière	TL/TT	



/ PILOT STREET RADIAL

Pouces	Réf.	Dimensions	Indice de charge et vitesse	Avant/arrières	TL/TT	Standard/Renforcé
17"	523459	130/70 x 17	62H		TL/TT	



/ CONTIGO!

Un pneu à nappes croisées récemment mis au point pour un usage polyvalent.

- Une adhérence idéale par tous les temps, toute l'année.
- Excellent kilométrage grâce à un mélange constamment remis à Niveau.
- Des sculptures innovantes pour une usure régulière et une bonne évacuation de l'eau.
- Construction améliorée de la carcasse pour une bonne tenue de route et une grande stabilité.

Pouces	Réf.	Dimensions	Indice de charge et vitesse	Avant/arrières	TL/TT	Standard/Renforcé
16"	504723	130/90 x 16	67H	arrière	TL	
17"	486805	130/80 x 17	65H	avant	TL	
18"	480229	110/90 x 18	61H	arrière	TL	
	486804	100/90 x 18	56H	avant	TL	
	486976	2,75 x 18	48P	avant/arrière	TT	
	486977	90/90 x 18	51H	avant	TL	



/ CONTICITY

Tout nouveau pneu développé pour la catégorie Allround/ City

- Une adhérence exceptionnelle sur la route grâce à un profil unique et triangulaire.
- Performances de roulage et rendement kilométrique améliorés.
- Des performances et une durabilité de pointe pour les motos légères et classiques.

Pouces	Réf.	Dimensions	Indice de charge et vitesse	Avant/arrières	TL/TT	Standard/Renforcé
17"	506385	3,00 x 17	50P	avant/arrière	TT	
	506386	80/90 x 17	50P	avant/arrière	TL	
	506387	90/90 x 17	49P	avant/arrière	TL	
18"	506384	2,75 x 18	48P	avant/arrière	TT	



/ CONTIMOTION

Nouveau profil pour moto sport-touring.

- Pour le motard recherchant un bon compromis.
- Tout nouveau concept de pneu radial pour le marché sport-tourisme.
- Fiables et sûrs sur routes sèches et mouillées.
- Kilométrage élevé grâce à de nouveaux polymères dans le mélange.
- Ceinture d'acier à 0° à l'arrière pour une excellente stabilité et un bon confort de Conduite.

Pouces	Réf.	Dimensions	Indice de charge et vitesse	Avant/arrières	TL/TT	Standard/Renforcé
17"	487066	110/70 x 17	54W	avant	TL	
	487067	120/60 x 17	55W	avant	TL	
	487068	120/70 x 17	58W	avant	TL	
	524186	140/70 ZR 17	66W	arriere	TL	
	524187	150/60 ZR 17	66W	arriere	TL	
	487069	150/70 x 17	69W	arrière	TL	
	487070	160/60 x 17	69W	arrière	TL	
	524188	170/60 ZR 17	72W	arriere	TL	
	487072	180/55 x 17	73W	arrière	TL	
	487073	190/50 x 17	73W	arrière	TL	

/ CONTIROAD



- Maniabilité : fabriqué pour améliorer votre confort de conduite et l'agilité de votre moto.
- Premium : un pneu premium inspiré par des générations vainqueurs de tests internationaux.
- Kilométrage : kilométrage élevé grâce à un profil unique et des composants modernes.
- Grip sur le mouillé : la nouvelle technologie RainGrip vous garantit une adhérence maximale sur l'asphalte mouillée et une température de chauffe toujours rapide
- Grip : Nouveau dessin pour un grip performant en toute situation.
- ZeroDegree : ceinture d'acier 0°
- Performance dans la durée : performances constantes sur toute la durée de vie du pneu.

Pouces	Réf.	Dimensions	Indice de charge et vitesse	Avant/arrières	TL/TT	Standard/ Renforcé
17"	524173	100/80 x 17	52S	avant		
	524174	110/70 x 17	54S	avant	TL	
	524175	110/70 x 17	54V	avant	TL	
	524176	120/70 ZR 17	58W	avant	TL	
	524177	130/70 x 17	62S	arrière	TL	
	524178	140/70 x 17	66S	arrière	TL	
	524179	140/70 x 17	66H	arrière	TL	
	524180	150/60 x 17	66V	arrière	TL	
	524181	150/70 ZR 17	69W	arrière	TL	
	524182	160/60 ZR 17	69W	arrière	TL	
	524183	180/55 ZR 17	73W	arrière	TL	
	524184	190/50 ZR 17	73W	arrière	TL	
	524185	190/55 ZR 17	75W	arrière	TL	



/ TKC70

Pouces	Réf.	Dimensions	Indice de charge et vitesse	Avant/arrières	TL/TT	Standard/ Renforcé
17"	524189	120/70 ZR 17	58W	avant	TL	
	524196	120/90 x 17	64T	arrière	TL	
	524205	130/80 x 17	65S	arrière	TL	
	524197	130/80 x 17	65T	arrière	TL	
	524206	140/80 x 17	69S	arrière	TL	
	524198	140/80 x 17	69H	arrière	TL	
	524207	150/60 ZR 17	69S	arrière	TL	
	524199	150/70 x 17	69V	arrière	TL	
	524200	160/60 ZR 17	69W	arrière	TL	
	524208	170/60 x 17	72S	arrière	TL	
	524201	170/60 x 17	72V	arrière	TL	
	524202	180/55 ZR 17	73W	arrière	TL	
19"	524191	100/90 x 19	57T	avant	TL	
	524192	110/80 x 19	59V	avant	TL	
	524193	120/70 x 19	60V	avant	TL	
18"	524190	110/80 x 18	58H	avant	TL	
	524209	150/70 x 18	70S	arrière	TL	
	524204	150/70 x 18	70H	arrière	TL	
21"	524203	4,00 x 18	64T	arrière	TT	
	524195	90/90 x 21	54H	avant	TL	
	524194	3,00 x 21	51T	avant	TT	



/ CONTITWIST SPORT SM

Pneu sport pour petites supermotos et autres motos jusqu'à 250 cc.

- Disponible en deux mélanges différents pour la route ou la route et le circuit.
- Tenue de route très légère et excellentes qualités dans les virages grâce au profil unique de la carcasse.
- Particulièrement stable dans les virages et sur ligne droite grâce à la composition ultramoderne de la carcasse.

Pouces	Réf.	Dimensions	Indice de charge et vitesse	Avant/arrières	TL/TT	Standard/Renforcé
17"	481328	100/80 x 17	52H	avant	TL	
	481329	130/70 x 17	62H	arrière	TL	



/ TKC80

Pouces	Réf.	Dimensions	Indice de charge et vitesse	Avant/arrières	TL/TT	Standard/Renforcé
17"	524210	120/70 x 17	58Q	avant	TL	
	524215	120/90 x 17	64S	arrière	TT	
	524216	130/80 x 17	65S	arrière	TT	
	524217	130/80 x 17	65T	arrière	TL	
	524218	5,10 x 17	67S	arrière	TT	
	524219	140/80 x 17	69Q	arrière	TL	
	524220	150/70 x 17	69Q	arrière	TL	
18"	524221	180/55 x 17	73Q	arrière	TL	
	524222	3,25 x 18	59S	arrière	TT	
	524223	3,50 x 18	62S	arrière	TT	
	524224	4,00 x 18	64R	arrière	TT	
	524225	120/90 x 18	65R	arrière	TT	
	524226	140/80 x 18	70R	arrière	TT	
	524227	150/70 x 18	70Q	arrière	TL	
19"	524228	150/70 x 18	70Q	arrière	TT	
	524211	100/90 x 19	57S	avant	TT	
21"	524212	2,50 x 21	48S	avant	TT	
	524213	3,00 x 21	51S	avant	TT	
	524214	90/90 x 21	54T	avant	TL	

/ TKC 80

Un pneu éprouvé, multi-usage pour route et hors route.

- Testé pour les longs trajets et la compétition.
- Sculptures autonettoyantes.
- Excellente stabilité latérale sur surfaces tendres.
- Très bonne tenue de route et excellent kilométrage.



Pouces	Réf.	Dimensions	Indice de charge et vitesse	Avant/arrières	TL/TT	Standard/Renforcé
17"	506383	170/60 x 17	72Q	arrière	TL	
18"	483112	110/80 x 18	58Q	arrière	TT	
	504724	4,10 x 18	66P	arrière	TT	
19"	504849	110/80 x 19	59Q	avant	TT	
	506382	120/70 x 19	60Q	avant	TL	
21"	483746	80/90 x 21	48Q	avant	TT	
	504725	90/90 x 21	54S	avant	TT	
	504726	2,75 x 21	52S	avant	TT	

/ CONTI ESCAPE

Un pneu spécial pour les motards à l'aise aussi bien sur route que hors route.

- Un mélange polyvalent pour tous les temps et tous les types de route.
- Bonne traction, même hors route, grâce à une orientation adaptée des sculptures.
- Rendement kilométrique élevé.



Pouces	Réf.	Dimensions	Indice de charge et vitesse	Avant/arrières	TL/TT	Standard/ Renforcé
18"	490433	4,10 x 18	60S	arrière	TT	
21"	490432	2,75 x 21	45S	avant	TT	

/ CONTI SPORTATTACK

Pneu de route supersport, également à l'aise sur le circuit.

- Une ceinture d'acier à 0° à l'avant comme à l'arrière garantit une excellente stabilité à grande vitesse.
- Bon contrôle du freinage dans les virages.
- Conception d'avant-garde des sculptures, idéales pour les motos sportives modernes.



Pouces	Réf.	Dimensions	Indice de charge et vitesse	Avant/arrières	TL/TT	Standard/ Renforcé
17"	503772	120/70 x 17	58W	avant	TL	
	503773	180/55 x 17	73W	arrière	TL	

/ CONTI SPORTATTACK 2

Pneu supersport aux performances de pointe.

- Tenue de route extraordinairement légère et précise, adhérence exceptionnelle et stabilité dans les virages.
- Construction spéciale sur les roues pour plus de stabilité et de réactivité au freinage et à l'accélération en sortie de virage.
- La technologie MultiGrip assure un kilométrage élevé et une adhérence maximale dans les virages serrés.
- TractionSkin permet de réduire fortement la période de rodage, en toute sécurité.



Pouces	Réf.	Dimensions	Indice de charge et vitesse	Avant/arrières	TL/TT	Standard/ Renforcé
17"	503769	120/70 x 17	58W	avant	TL	
	503770	160/60 x 17	69W	arrière	TL	
	503771	180/55 x 17	73W	arrière	TL	



/ CONTI STREET

Pouces	Réf.	Dimensions	Indice de charge et vitesse	Avant/arrières	TL/TT	Standard/ Renforcé
17"	523500	90/80 x 17	46P		TL	
	523503	3,00 x 17	50P		TL	
	523504	80/90 x 17	50P		TL	
	523505	100/90 x 17	55P		TL	
	523506	120/70 x 17	58P		TL	
	523512	2,50 x 17	43P		TL	
	523513	2,75 x 17	47P		TL	
	523499	70/90 x 17	38P		TL	
18"	523501	2,50 x 18	40P		TL	
	523502	80/100 x 18	47P		TL	
	523507	3,00 x 18	52P		TL	
	523508	80/90 x 18	45P		TL	
	523509	90/90 x 18	57P		TL	
	523510	100/80 x 18	53P		TL	
	523511	100/90 x 18	56P		TL	
	523514	2,50 x 18	48P		TL	

/ ARROWMAX STREETSMART

Pneumatique sport touring conventionnel de conception moderne, destiné aux motos classiques.

- Idéal pour les motos légères et classiques
- Design élégant
- Performances de pointe
- Mélanges innovants à base d'une silice spécifique garantissant un compromis parfait entre adhérence sur sol ouillé et performances kilométriques



Pouces	Réf.	Dimensions	Indice de charge et vitesse	Avant/arrières	TL/TT	Standard/ Renforcé
16"	518387	110/90 x 16	59V	avant	TL	
	518389	120/80 x 16	60V	avant	TL	
	518394	130/90 x 16	67V	arrière	TL	
17"	518380	100/80 x 17	52H	arrière	TL	
	518383	110/70 x 17	54H	arrière	TL	
	518384	110/80 x 17	57S	arrière	TL	
	518385	110/80 x 17	57V	avant	TL	
	518391	130/70 x 17	62H	arrière	TL	
	518392	130/80 x 17	65H	arrière	TL	
	518395	130/90 x 17	68V	arrière	TL	
	518396	140/80 x 17	69V	arrière	TL	
	518397	150/70 x 17	69V	arrière	TL	
	518398	160/70 x 17	73V	arrière	TL	
18"	518381	100/90 x 18	56V	avant	TL	
	518386	110/80 x 18	58V	avant	TL	
	518388	110/90 x 18	61V	avant	TL	
	518390	120/90 x 18	65V	arrière	TL	
	518393	130/80 x 18	66V	arrière	TL	
	518400	4,00 x 18	64H	arrière	TL	
19"	518382	100/90 x 19	57V	avant	TL	
	518399	3,25 x 19	54H	avant	TL	
	518401	90/90 x 19	52H	avant	TL	

/ ROADSMART II

Pneumatique sport touring multi-gommes haut de gamme.

- Bandage sans joint (JLB) à l'avant et à l'arrière pour une stabilité accrue
- Technologie Multi-Tread/ Multi-gomme à l'arrière pour une longévité exceptionnelle
- Dessin de la bande de roulement spécialement conçu, offrant des distances de freinage plus courtes par temps sec ou pluvieux
- Carcasse spécialement conçue pour une plus grande maniabilité et un comportement plus neutre à basse vitesse ou haute vitesse



Pouces	Réf.	Dimensions	Indice de charge et vitesse	Avant/arrières	TL/TT	Standard/ Renforcé
17"	518407	120/60 x 17	55W	avant	TL	
	518408	120/70 x 17	58W	avant	TL	
	518410	160/60 x 17	69W	arrière	TL	
	518412	170/60 x 17	72W	arrière	TL	
	518413	180/55 x 17	73W	arrière	TL	
	518414	190/50 x 17	73W	avant/arrière	TL	
18"	518409	120/70 x 18	59W	avant	TL	
	518411	160/60 x 18	70W		TL	



/ SX Q-LITE

-Pneu sport touring haute performance-Destiné au pilotage quotidien des motards exigeants-Sportives de moyenne cylindrée-Dérivé des performances des meilleurs pneus radiaux-Amélioration du potentiel kilométrique-Constance et maniabilité contribuant à la c

Pouces	Réf.	Dimensions	Indice de charge et vitesse	Avant/arrières	TL/TT	Standard/Renforcé
17"	523474	100/80 x 17	52H	avant		
	523475	100/80 x 17	52S	avant/arrière	TL	
	523476	110/70 x 17	54H	avant	TL	
	523477	120/70 x 17	58S	arrière	TL	
	523478	130/70 x 17	62H	arrière	TL	
	523479	140/70 x 17	66H	arrière	TL	
	523480	150/60 x 17	66H	arrière	TL	
	523481	70/90 x 17	38S	arrière	TL	
	523482	80/90 x 17	44S	arrière	TL	
523483	80/90 x 17	46S	arrière	TL		



/ TT900 GP

Pneumatique à forte adhérence pour les motos de petite cylindrée.

- Une bande de roulement optimisée pour des angles d'inclinaison optimaux

Pouces	Réf.	Dimensions	Indice de charge et vitesse	Avant/arrières	TL/TT	Standard/Renforcé
17"	506822	110/70 x 17	54H	avant	TL	
	506823	140/70 x 17	66H	arrière	TL	



/ TT900

Pneumatique à forte adhérence pour les motos de petite cylindrée.

- Une bande de roulement optimisée pour des angles d'inclinaison optimaux

Pouces	Réf.	Dimensions	Indice de charge et vitesse	Avant/arrières	TL/TT	Standard/Renforcé
17"	506811	2,50 x 17	43P	avant/arrière	TT	
	506812	2,75 x 17	47P	avant/arrière	TT	
	506820	100/80 x 17	52S	avant	TL	
	506821	130/70 x 17	62S	arrière	TL	



/ K82

Pneu pour sportive et routière conçu pour les motos plus classiques et légères.

- Le pneu idéal pour les motos plus classiques et légères
- Bande de roulement historique avec technologie moderne

Pouces	Réf.	Dimensions	Indice de charge et vitesse	Avant/arrières	TL/TT	Standard/Renforcé
16"	518406	4,60 x 16	59S	arrière	TT	
18"	518402	2,75 x 18	42S	avant/arrière	TT	
	518403	3,00 x 18	47S	avant/arrière	TT	
	518404	3,25 x 18	52S	avant/arrière	TT	
	518405	3,50 x 18	56S	avant/arrière	TT	



/ D102

Pneumatique Dunlop destiné aux sportives de petite cylindrée.

Pouces	Réf.	Dimensions	Indice de charge et vitesse	Avant/arrières	TL/TT	Standard/Renforcé
17"	506813	90/80 x 17	46S	avant	TL	
	506814	130/70 x 17	62S	arrière	TL	



/ D104

Pneumatique Dunlop pour un usage quotidien en confiance.

Pouces	Réf.	Dimensions	Indice de charge et vitesse	Avant/arrières	TL/TT	Standard/Renforcé
17"	506815	2,50 x 17	38L	avant	TL	
	506816	2,50 x 17	38L	arrière	TL	
	506817	2,75 x 17	41P	arrière	TT	



/ D110

Pneumatique Dunlop pour un usage quotidien en confiance.

Pouces	Réf.	Dimensions	Indice de charge et vitesse	Avant/arrières	TL/TT	Standard/Renforcé
16"	506818	70/90 x 16	36P	avant	TL	
	506819	80/90 x 16	43P	arrière	TL	



/ GEOMAX MX33

Efficace partout

- Pneu tout terrain, avec un champ d'application inhabituellement large
- Performances optimisées combinées à une durabilité améliorée lors d'une utilisation sur un terrain intermédiaire
- Contrôle amélioré de traction / glisse par l'utilisation de nouveaux composants
- Meilleur contrôle et absorption des chocs grâce à une construction de carcasse redessinée.

Pouces	Réf.	Dimensions	Indice de charge et vitesse	Avant/arrières	TL/TT	Standard/Renforcé
10"	511580	60/80 x 10	33J	avant	TT	
	511584	70/100 x 10	41J	arrière	TT	
12"	511581	60/100 x 12	36J	avant	TT	
	511585	80/100 x 12	41M	arrière	TT	
14"	511582	60/100 x 14	29M	avant	TT	
	511586	90/100 x 14	49M	arrière	TT	
17"	511593	70/100 x 17	40M	avant	TT	
19"	519395	70/100 x 19	42M	avant	TT	
	526224	90/110 x 19		arrière	TT	



/ GEOMAX MX34

- Efficace partout
- Pneu tout terrain, avec un champ d'application inhabituellement large
- Performances optimisées combinées à une durabilité améliorée lors d'une utilisation sur un terrain intermédiaire
- Contrôle amélioré de traction / glisse par l'utilisation de nouveaux composants
- Meilleur contrôle et absorption des chocs grâce à une construction de carcasse redessinée

Pouces	Réf.	Dimensions	Indice de charge et vitesse	Avant/arrières	TL/TT	Standard/Renforcé
19"	526671	90/100 x 19	57M	arrière	TT	
21"	526225	80/100 x 21	51M		TT	



/ QUALIFIER CORE

- La technologie HCT permet au mélange de gomme d'apporter un très haut niveau de performance
- Maniabilité exceptionnelle grâce à la technologie DFF mise en œuvre pour développer le profil de ce Dunlop
- Le dessin de la bande de roulement directement inspiré de SportSmart de première génération offre une rigidité équilibrée de la bande de roulement, une empreinte au sol optimisée, une usure uniforme et contribue également à son efficacité sur sol mouillé.

Pouces	Réf.	Dimensions	Indice de charge et vitesse	Avant/arrières	TL/TT	Standard/Renforcé
17"	518377	120/70 x 17	58W	avant	TL	
	518378	160/60 x 17	69W	arrière	TL	
	518379	180/55 x 17	73W	arrière	TL	

DELI TIRE



/ SB101

Pouces	Réf.	Dimensions	Indice de charge et vitesse	Avant/arrières	TL/TT	Standard/ Renforcé
17"	460440	90/80 x17	46P		TL	

DELI TIRE



/ SB106

Pouces	Réf.	Dimensions	Indice de charge et vitesse	Avant/arrières	TL/TT	Standard/ Renforcé
17"	460438	100/80 x17	52R	avant/arrière	TL	
	460441	130/70 x17	62R	arrière	TL	

DELI TIRE



/ SB128 SAMURAI

Pouces	Réf.	Dimensions	Indice de charge et vitesse	Avant/arrières	TL/TT	Standard/ Renforcé
17"	483483	130/70 x17	62H	avant/arrière	TL	
	483484	100/80 x17	52R	avant/arrière	TL	

DELI TIRE



/ SB107

Pouces	Réf.	Dimensions	Indice de charge et vitesse	Avant/arrières	TL/TT	Standard/ Renforcé
18"	461004	110/80 x 18	58P	avant/arrière	TT	
21"	461005	80/90 x 21	48P	avant/arrière	TT	

DELI TIRE



/ SB117

Pouces	Réf.	Dimensions	Indice de charge et vitesse	Avant/arrières	TL/TT	Standard/Renforcé
18"	479677	100/80 x 18	53P	avant/arrière	TT	
21"	478583	90/90 x 21	54R	avant/arrière	TT	

DELI TIRE



/ SB120

Pouces	Réf.	Dimensions	Indice de charge et vitesse	Avant/arrières	TL/TT	Standard/Renforcé
21"	480312	90/90 x 21	54R	avant/arrière	TL	

DELI TIRE



/ SB151

Pouces	Réf.	Dimensions	Indice de charge et vitesse	Avant/arrières	TL/TT	Standard/Renforcé
17"	520848	130/70 x 17	62S		TL	
	520847	100/80 x 17	52R		TL	
	520849	140/70 x 17	66H		TL	

DELI TIRE



/ SB114

Pouces	Réf.	Dimensions	Indice de charge et vitesse	Avant/arrières	TL/TT	Standard/Renforcé
10"	483845	2,50 x 10	33J	avant	TT	
12"	468387	80/100 x 12	50M	arrière	TT	
14"	468386	60/100 x 14	30M	arrière	TT	

obor



/ SR30

Pouces	Réf.	Dimensions	Indice de charge et vitesse	Avant/arrières	TL/TT	Standard/ Renforcé
17"	513909	100/80 x 17	58S	avant	TL	
	513910	130/70 x 17	62P	arrière	TL	

obor



/ TT (COMPATIBLE SUR-RON)

Pouces	Réf.	Dimensions	Indice de charge et vitesse	Avant/arrières	TL/TT	Standard/ Renforcé
19"	524142	70/100 x 19			TT	

MOTEUR
CYCLE
PNEUMATIQUE
ATELIER
ACCESSOIRES
ÉLECTRICITÉ
FILTRATION
FREINAGE
TRANSMISSION



Pouces	Dimensions	Réf.	Modèle	Réf.	Modèle	Réf.	Modèle
10"	2 3/4 x 10						
	2 x 16			500376	KKSIO		
	2 1/4 x 16			500388	CONTIGO		
16"				500377	KKSIO REINF		
				500390	CONTIGO REINF		
	2 1/2 x 16			500389	CONTIGO		
				500378	KKSIO REINF		
	2 3/4 x 16			500391	CONTIGO		
	2 x 17			500379	KKSIO		
	2,25 x 17	518171	CITY EXTRA REINF			506815	D104 FRONT
	2,50 x 17	510654	CITY PRO REINF			506816	D104 REAR
		518172	CITY EXTRA REINF			506811	TT900 FRONT/REAR
	2,75 x 17	510655	CITY PRO REINF			506817	D104 REAR
		518173	CITY EXTRA REINF			506812	TT900 FRONT/REAR
17"	2 1/4 x 17			500392	CONTIGO		
				500380	KKSIO REINF		
	2 1/2 x 17			500381	KKSIO REINF		
				500393	CONTIGO		
2 3/4 x 17			500385	KKSIO REINF FLANC BLANC			
18"	2 1/4 x 18						
	2,75 x 18	518174	CITY EXTRA REINF				
	3,00 x 18	518175	CITY EXTRA REINF				
19"	13/4 x 19						
	2 x 19			500382	KKSIO		
					480984	KKSIO FLANC BLANC	
	2 1/4 x 19			500386	KKSIO REINF FLANC BLANC		
					500383	KKSIO REINF	
	2 1/2 x 19			500387	KKSIO REINF FLANC BLANC		
22"	2 x 22			500384	KKSIO		

DELI TIRE		HUTCHINSON		Vee Rubber		TEKNIX	
Réf.	Modèle	Réf.	Modèle	Réf.	Modèle	Réf.	Modèle
				511594	VRM52		
		122135	VROOM				
465467	SBI08	454921	SPHERUS REINF				
		454920	SPHERUS REINF				
460442	SBI08	454922	SPHERUS REINF				
519972	S240						
460443	S240						
		164008	VROOM				
460444	S215	3831	GPI				
		454924	SPHERUS REINF				
		122082	TURBO				
		164057	GPI				
460445	S215	3834	GPI				
		164084	TURBO				
		164103	VROOM				
		122738	NERVURE REINF			517738	NERVURE REINF
		521366	NERVURE REINF FLANC BEIGE			517737	NERVURE REINF FLANC BLANC
		164137	VROOM				



/ CITY EXTRA REINF

Pouces	Réf.	Dimensions	Indice de charge et vitesse	Avant/arrières	TL/TT	Standard/ Renforcé
17"	518172	2,50 x 17	43P		TT	
	518173	2,75 x 17	47P		TT	
	518171	2,25 x 17	38P		TT	
18"	518174	2,75 x 18	48S		TL	
	518175	3,00 x 18	52S		TL/TT	



/ CITY PRO REINF

Pneu moto. Destiné aux motos de petites cylindrées pour un usage quotidien, urbain et périurbain. Parfait équilibre entre un pneu utilitaire et un pneu sport. Architecture renforcée et sculpture dérivée de la gamme de pneus MICHELIN pour motos sportives.

Pouces	Réf.	Dimensions	Indice de charge et vitesse	Avant/arrières	TL/TT	Standard/ Renforcé
17"	510654	2,50 x 17	43P		TT	
	510655	2,75 x 17	47P		TT	



/ CONTIGO

- Un pneu urbain pour les petites motos.
- Kilométrage élevé et très bonne adhérence par tous les temps et sur tous types de routes, grâce à un mélange innovant.
- Des sculptures innovantes pour une usure régulière et un aspect moderne.
- Pour tous les touche-à-tout

Pouces	Réf.	Dimensions	Indice de charge et vitesse	Avant/arrières	TL/TT	Standard/ Renforcé
16"	500388	1/4 x 16	38J		TT	
	500389	2 1/2 x 16	42J		TT	
	500390	2 1/2 x 16	42M		TT	
	500391	2 3/4 x 16	46M		TT	
17"	500392	2 1/4 x 17	39J		TT	
	500393	2 3/4 x 17	47J		TT	



/ KKS10

- Pour les cyclomoteurs de 50 cm³.
- Fiabilité, durabilité, agilité sont les principales caractéristiques du KKS10.
- La conception spéciale du centre de la bande de roulement assure un rendement kilométrique élevé, les larges sculptures offrent une bonne adhérence

Pouces	Réf.	Dimensions	Indice de charge et vitesse	Avant/arrières	TL/TT	Standard/ Renforcé
16"	500376	2 x 16	20B	TT		
	500377	2 1/4 x 16	38B	TT		
	500378	2 1/2 x 16	42B	TT		
17"	500379	2 x 17	22B	TT		
	500380	2 1/4 x 17	39B	TT		
	500381	2 1/2 x 17	43B	TT		
	500385	2 3/4 x 17	47J	TT		
19"	480984	2 x 19	24B	TT		
	500382	2 x 19	24B	TT		
	500383	2 1/4 x 19	41B	TT		
	500386	2 1/4 x 19	41B	TT		
	500387	2 1/2 x 19	45J	TT		
22"	500384	2 x 22	26B	TT		



/ D104

- Pneumatique Dunlop pour un usage quotidien en confiance.

Pouces	Réf.	Dimensions	Indice de charge et vitesse	Avant/arrières	TL/TT	Standard/ Renforcé
17"	506815	2,50 x 17	38L	avant	TT	
	506816	2,50 x 17	38L	arrière	TT	
	506817	2,75 x 17	41P	arrière	TT	



/ TT900 GP

- Pneumatique à forte adhérence pour les motos de petite cylindrée.
- Une bande de roulement optimisée pour des angles d'inclinaison optimaux

Pouces	Réf.	Dimensions	Indice de charge et vitesse	Avant/arrières	TL/TT	Standard/ Renforcé
17"	506811	2,50 x 17	43P	avant/arrière	TT	
	506812	2,75 x 17	47P	avant/arrière	TT	

DELI TIRE



/ SB108

Pouces	Réf.	Dimensions	Indice de charge et vitesse	Avant/arrières	TL/TT	Standard/Renforcé
16"	460442	2 1/2 x 16	31J		TL	
	465467	2 1/4 x 16	38J		TT	

DELI TIRE



/ S240

Pouces	Réf.	Dimensions	Indice de charge et vitesse	Avant/arrières	TL/TT	Standard/Renforcé
16"	460443	2 3/4 x 16	36J		TT	
	519972	2 3/4 x 16	46P		TL	

DELI TIRE



/ S215

Pouces	Réf.	Dimensions	Indice de charge et vitesse	Avant/arrières	TL/TT	Standard/Renforcé
17"	460444	2 1/4 x 17	28J		TT	
	460445	2 3/4 x 17	38J		TL/TT	

HUTCHINSON



/ SPHERUS REINF

Pouces	Réf.	Dimensions	Indice de charge et vitesse	Avant/arrières	TL/TT	Standard/Renforcé
16"	454920	2 1/4 x 16	38B		TT	
	454921	2 1/4 x 16	38B		TL	
	454922	2 1/2 x 16	42B		TL	
17"	454924	2 1/4 x 17	39B		TT	

HUTCHINSON®



/ NERVURE REINF

Pouces	Réf.	Dimensions	Indice de charge et vitesse	Avant/arrières	TL/TT	Standard/ Renforcé
19"	122738	13/4 x 19	21B		TT	
	521366	13/4 x 19	21B		TT	Flanc beige

HUTCHINSON®



/ TURBO

Pouces	Réf.	Dimensions	Indice de charge et vitesse	Avant/arrières	TL/TT	Standard/ Renforcé
17"	122082	2 1/4 x 17	39J		TT	
	164084	2 3/4 x 17	47J		TT	

HUTCHINSON®



/ GP1

Pouces	Réf.	Dimensions	Indice de charge et vitesse	Avant/arrières	TL/TT	Standard/ Renforcé
17"	164057	2 1/2 x 17	35L		TT	
	3831	2 1/4 x 17	38L		TT	
	3834	2 3/4 x 17	35L		TT	

HUTCHINSON®



/ VROOM

Pouces	Réf.	Dimensions	Indice de charge et vitesse	Avant/arrières	TL/TT	Standard/ Renforcé
16"	122135	2 x 16	20B		TT	
17"	164008	2 x 17	47J		TT	
18"	164103	2 1/4 x 18	38J		TT	
19"	164137	2 x 19	24B		TT	

PNEUS CYCLO / MOPED TYRES

CGN
 LE SENS DU DÉTAIL

Vee Rubber

/ VRM52

Pouces	Réf.	Dimensions	Indice de charge et vitesse	Avant/arrières	TL/TT	Standard/ Renforcé
10"	511594	2 3/4 x 10			TL	

TEKNIX
Original Heavy Duty

/ NERVURE REINF

Pouces	Réf.	Dimensions	Indice de charge et vitesse	Avant/arrières	TL/TT	Standard/ Renforcé
19"	517738	1 3/4 x 19	21B		TT	Flanc blanc
	517737	1 3/4 x 19	T21B		TT	

CHAMBRE À AIR SCOOTER / INNER TUBE

Continental
 The Future in Motion

/ VALVE COUDEE 90°

Pouces	Réf.	Dimensions
8"	503073	3.50-4.00X8
10"	503074	3.00-3.50-4.00-4.10X10/90/90X10 A 110/90X10

Continental
 The Future in Motion

/ VALVE TR4 DROITE

Pouces	Réf.	Dimensions
12"	503075	DIRT 3.00-3.50X12 / 80/100X12
	503076	120/130/70X12 - 130-140/60X13 4.00X12

DELITIRE



/ VALVE TR4 DROITE

Pouces	Réf.	Dimensions
8"	389460	3.50-4.00X8
	3886	120/90X10-130/90X10 - 4.00/4.50X10
10"	3883	3.00-3.25X10 / 90/90X10 / 100/90X10
	484306	DIRT 2.50-2.75X10
13"	251048	130/60X13-140/60X13

DELITIRE



/ VALVE DROITE

Pouces	Réf.	Dimensions
12"	479841	DIRT 3.00/3.50X12
	251033	120/70X12 - 130/70X12 - 4.00X12
14"	481792	DIRT 2.50 A 2.75X14

MICHELIN



/ VALVE COUDEE 90°

Pouces	Réf.	Dimensions
4"	3669	POCKET 4.00X4 (4AB)
8"	3665	4.50X8 (8C3)
9"	121249	2.75X9 (9AB3)
10"	3668	120/90-130/90-130/70-4.50X10 (10D)
	3667	4.00X10 (10C3)
	3661	3.00X10 A 110/80X10 VC90° (10B4)

MICHELIN



/ VALVE COUDEE 90°

Pouces	Réf.	Dimensions
8"	3664	4.00X8 (8B4)
10"	512732	DIRT 2.50/2.75X10 (10MBR)
	454918	4.00X10 A 4.50X10 (10CG13)



/ VALVE TR4

Pouces	Réf.	Dimensions
12"	489846	2.50 X12 / 80/100X12 (12MCR)



/ VALVE COUDEE 150°

Pouces	Réf.	Dimensions
8"	320378	3.50X8 (8B1)
10"	320382	3.00X10 A 110/80X10 VC150° (10B1)
12"	320397	DIRT 3.00-3.50X12 (12B1)



/ VALVE COUDEE 90°

Pouces	Réf.	Dimensions
4"	494063	POCKET 3.00X4



/ VALVE DROITE FILETEE

Pouces	Réf.	Dimensions
14"	478273	DIRT 2.50/3.00X14 -80/80/14

Continental
The Future is Now



/ VALVE TR4 DROITE

Pouces	Réf.	Dimensions
16"	503054	3.00-3.25X16 - 90/90X16
	503055	3.25-3.50X16 - 100/90X16
	503056	4.00-4.50X16 - 110 à 120/80X16
	503057	5.00-5.10X16 - 130 à 140/80X16
17"	503058	3.00-3.25X17 - 100/110X80X17
	503059	3.25-3.50X17 - 120X80X17
	503060	4.00-4.50X17 -110/120/70X17-110/80X17
18"	503061	18" 2.25-2.50X18
	503062	18" 2.50-2.75X18
	503063	18" 3.00-3.25X18
	503064	18" 3.50-4.00X18
	503065	18" 4.00-4.50X18
	503070	4.00-5.00X18
19"	503066	3.25-3.50X19
	503067	3.50-4.00X19
	503071	3.50X19
21"	503068	2.50-2.50X21
	503069	2.75-3.00X21 90/90X21 100/80X21 110/80X21
	503072	3.00X21

DELITIRE



/ VALVE TR4 DROITE

Pouces	Réf.	Dimensions
16"	389508	3.00-3.25X16 - 90/90X16 - 100/90x16 - 100/80 A 120/80
	389512	4.50-5.10X16 - 120/90X16 A 140/90X16
17"	389531	3.00-3.25X17 - 100/110X80X17
	389546	4.50-5.10X17 -130/90-140/80 -140/90
18"	280062	2.75-3.00X18 - 90/90X18
	280096	3.25-3.50X18 - 100/90X18
	449931	4.00-4.50X18 - 110/90 - 120/80 A 140/80
19"	389570	3.25-3.50X19 - 90/90X19 - 100/90X19
21"	375505	2.50-2.75-3.00X21 - 80/90 - 90/90X21
	375510	2.75-3.00X21 90/90X21 100/80X21 110/80X21



/ VALVE TR4 DROITE

Pouces	Réf.	Dimensions
14"	505586	90/100X14
	465651	2.50-2.75-80X16 - 90/80X16
16"	465653	3.25-3.50X16 - 100/90X16
	320488	4.00-4.50x16 - 110 à 120/80X16
	480110	4.25-5.50x16 -120 à 130/90 - 150/80X16
	465650	2.25-2.50X17
17"	3672	2.75X17
	3673	3.00X17 - 100/80X17
	465655	4.00-4.50x17 -110/120/70X17-110/80X17
	320511	4.50-5.10X17 120 /140/70X17 130/80X17
	3674	4.50-5.50x17-130/90-140/80-150/70-160/70X17
	497443	120/90X18
18"	497445	140/80X18
	3675	2.50X18
	3676	2.75-3.00X18 - 90/90X18
	460472	3.25-3.50-100-110/90-110-120/80X18
	497446	100/110/90X19-120/80X19
19"	320550	3.00X19 - 90/90X19
	3679	3.25X19 - 100/90-110/80-110/90X19
	500918	70/100X19
	460473	2.50-2.75-3.00X21 - 80 à 90/90 X100X21
21"	460691	3.00-3.50x21 - 90/90X21 - 100/80X21
	497447	90/90X21-80/100X21



/ VALVE TR4 DROITE

Pouces	Réf.	Dimensions
15"	454915	4.50-5.50x15 150/90-170/80-180/70X15
	363285	4.50X15 - 130/90X15
16"	465654	4.25-5.50x16 120/130/90 140/150/80X16

Continental
The Future in Motion



/ VS

Pouces	Réf.	Dimensions
16"	503077	2 1/4-2 1/2 X16
	503078	2 1/4-2 1/2 X16
	503079	2 3/4X16
17"	503080	2 1/4-2 1/2X17
	503081	2 3/4X17
19"	503083	2-2 1/4-2 1/2X19

DELITIRE



/ VS VALVE DROITE

Pouces	Réf.	Dimensions
16"	3878	2 1/4X16
	389455	2 3/4X16
17"	3882	2 1/4X17
	3880	2 3/4X17
18"	187590	2 1/4X18
19"	483744	1-3/4X19/2X19

DELITIRE



/ VP VALVE DROITE

Pouces	Réf.	Dimensions
17"	3879	2 1/4X17
19"	483743	1-3/4X19/2X19

DELITIRE



/ VALVE DROITE FILETEE

Pouces	Réf.	Dimensions
16"	482494	2 1/4X16

DELITIRE

/ VS VALVE DROITE FILETEE AVEC ECROU

Pouces	Réf.	Dimensions
17"	482495	2 1/4X17
	482496	2 3/4X17

/ VS

HUTCHINSON

Pouces	Réf.	Dimensions
16"	165774	2 1/4-2 1/2 X16
	164433	2 3/4X16
17"	165573	2 1/4-2 1/2X17
	164387	2 3/4X17
18"	165588	2 1/4X18
19"	454928	2X19

HUTCHINSON

/ VP

Pouces	Réf.	Dimensions
17"	164395	2 1/4-2 1/2X17
18"	164361	2 1/4X18
19"	164319	2X19



175767



3933



3934



484130

/ FOND DE JANTE CYCLO

Pouces	Réf.	Désignation
16"	175767	28MM (2X16)
17"	3933	19MM (2X17)
	3934	30MM (2-1/4X17)
18"	484130	30MM (2-1/4X18)



482985



482984



482986



482987



482988



482989



/ FOND DE JANTE CYCLO

Pouces	Réf.	Désignation
12"	482984	24MM
15"	482985	46MM
16"	482986	28MM
17"	482987	42MM
18/19"	482988	28MM
21"	482989	28MM



/ GRIPSTER ROUE MOTO



Description	Réf.
1.60» POUR PNEU AVANT ET ARRIERE (2.50/3.00)	524262
1.85» POUR PNEU ARRIERE (3.25/3.50)	524263
2.15» POUR PNEU ARRIERE (4.00/4.25)	524264



/ GRIPSTER ROUE MOTO



504619



504620

Description	Réf.
1.60MM POUR PNEU AVANT ET ARRIERE	504619
1.85MM POUR PNEU ARRIERE	504620

MOTEUR

CYCLE

PNEUMATIQUE

ATELIER

ACCESSOIRES

ÉLECTRICITÉ

FILTRATION

FREINAGE

TRANSMISSION





/ LUBRIFIANT / LUBRICANT	378
/ OUTILLAGE / TOOLS	438
/ MAINTENANCE VEHICULE / VEHICLE MAINTENANCE	475
/ VISSERIE / NUTS AND BOLTS	488
/ IMMATRICULATION / NUMBER PLATES	492



MOTEUR

CYCLE

PNEUMATIQUE

ATELIER

ACCESSOIRES

ÉLECTRICITÉ

FILTRATION

FREINAGE

TRANSMISSION





DRIVEN BY TECHNOLOGY

**SPÉCIALISTE DES
LUBRIFIANTS POUR
LES DEUX-ROUES
MOTORISÉS.**



**DES PRODUITS D'EXCELLENCE, SERVICE
DE QUALITÉ SUPÉRIEURE.**

PASSEZ À PUTOLINE OIL.

Putoline®

MOTORCYCLE OILS

PUTOLINE OIL, PILOTÉE PAR LA TECHNOLOGIE !

Putoline Oil propose des produits pour deux-roues à moteur. C'est ce qui rend Putoline Oil unique !

En 1970, Jan Put fonde Putoline Oil et lui donne son nom. La gamme se composait de lubrifiants pour vélos et cyclomoteurs. Cependant, Jan avait une passion pour les motocross et la gamme s'est rapidement élargie vers des produits motos.

Putoline Oil s'agrandit et devient rapidement une référence pour les pilotes.

Putoline Oil s'internationalise au début des années 1980 et exporte ses produits. Dans les années qui suivent, la gamme de produits ne cesse de s'élargir. Aujourd'hui Putoline Oil possède la plus grande gamme au monde de lubrifiants et de produits d'entretien pour motos et qu'elle exporte dans plus de 40 pays !

Expérience et développement :

Au fil des années, Putoline a acquis une grande expérience grâce à sa présence sur les circuits.

En tant que fabricant indépendant, Putoline peut réagir aux développements du marché et aux évolutions techniques. L'introduction de la nouvelle technologie révolutionnaire d'additifs N-TECH® dans le monde de la moto, en est un excellent exemple.

Putoline ne cesse de créer des produits pilotés par la technologie !

HUILES 2 TEMPS SCOOTERS	380
HUILES 2 TEMPS MOTOS	381
HUILES 4 TEMPS SCOOTERS	384
HUILES 4 TEMPS MOTOS	385
HUILES 2 ET 4 TEMPS	390
HUILES DE BOITE / TRANSMISSION	391
HUILES DE FOURCHE	393
LIQUIDES DE REFROIDISSEMENT	395
MAINTENANCE PNEU	396
MAINTENANCE FREIN	396
MAINTENANCE CHAÎNE	397
MAINTENANCE FILTRE À AIR	398
CARBURATION	399
MAINTENANCE AÉROSOL	401
MAINTENANCE SPRAY	403
GRAISSE	404
SAVON	405

HUILE MOTEUR 2 TEMPS SCOOTER



/ HUILE S2 SEMI-SYNTHÉTIQUE

- S2 est une huile 2 temps semi-synthétique
- Elle répond aux normes JASO et API
- Contient un colorant rouge pour être clairement visible dans le carburant
- L'huile est adaptée pour les motos de route et tout-terrain, scooters et véhicules tout-terrain utilisés dans des conditions normales
- Utilisez S2 pour les systèmes avec pré-mélange ou lubrification automatique
- Proportion de 2-4 %

493972

Bidon

1L

SPÉCIFICATIONS DU PRODUIT : API TC / JASO FD / ISO-L-EGD

ANALYSES STANDARD :

	COULEUR ROUGE	INDICE DE VISCOSITÉ	129	ALKALINITÉ, MGKOH/G	1,4
DENSITÉ À 15°C, KG/L	0,870	POINT D'ÉCLAIR PM, °C	100	SULFATE DE CENDRE, %	0,14
VISCOSITÉ 40°C, MM²/S	64,60	POINT D'ÉCLAIR COC, °C	116		
VISCOSITÉ 100°C, MM²/S	9,50	POINT D'ÉCOULEMENT, °C	-24		



500275

BIB*

20L



494185

Fût

60L



/ HUILE TT SCOOTER SYNTHÉTIQUE

- Contient un colorant rouge pour être clairement visible dans le carburant
- TT Scooter est une huile moteur 2 temps à combustion propre, à faible dégagement de fumée et à hautes performances
- Réduit la formation de fumée et les dépôts de carbone
- Recommandée pour un usage sur route régulier et à haute performance
- Adaptée pour les systèmes à pré-mélange et à injection
- Proportion recommandée : 2-4 %

477378

Bidon

1L

SPÉCIFICATIONS DU PRODUIT : API TC / JASO FD / ISO-L-EGD / TISI

ANALYSES STANDARD TYPIQUES :

COULEUR	ROUGE	VISCOSITÉ 40°C, MM²/S	33,70	POINT D'ÉCLAIR COC, °C	122
DENSITÉ À 15°C, KG/L	0,855	VISCOSITÉ 100°C, MM²/S	6,75	POINT D'ÉCOULEMENT, °C	-39
		INDICE DE VISCOSITÉ	153	ALKALINITÉ, MGKOH/G	1,4



/ HUILE 2T TT SCOOTER SYNTHÉTIQUE SENTEUR FRAISE

TT Scooter Scented est une huile moteur 2 temps à combustion propre, à faible dégagement de fumée et à hautes performances. Le produit a les propriétés suivantes :

- Réduit la formation de fumée
 - Réduit les dépôts de carbone
 - Contrebalance l'encrassement des bougies d'allumage
 - Prolonge la durée de vie du moteur TT Scooter Scented est recommandée pour un usage sur route régulier et à haute performance. Elle est adaptée pour les systèmes à prémélange et à injection.
- Proportion recommandée : 2-4 %. Parfum fraise

476534

Bidon

1L

SPÉCIFICATIONS DU PRODUIT : API TC / JASO FD / TISI

ANALYSES STANDARD TYPIQUES :

COULEUR	ROUGE	VISCOSITÉ 100°C, MM²/S	710	POINT D'ÉCOULEMENT, °C	-45
DENSITÉ À 15°C, KG/L	0,862	INDICE DE VISCOSITÉ	147	ALKALINITÉ, MGKOH/G	1,4
VISCOSITÉ 40°C, MM²/S	38,70	POINT D'ÉCLAIR COC, °C	122		

HUILE MOTEUR 2 TEMPS SCOOTER



/ HUILE CLASSIC SCOOTER SYNTHÉTIQUE (SPÉCIALE VESPA/LAMBRETTA)

494122

Bidon

1L

- Contient un colorant rouge pour être clairement visible dans le carburant
- Classic Scooter est une huile pour scooter de première qualité
- Convient aux scooters Lambretta, Vespa et aux autres scooters 2 temps classiques et modernes, à pré-mélange ou à injecteur
- Offre une protection complète en utilisation régulière
- Proportion de 2-4 %

SPÉCIFICATIONS DU PRODUIT : API TC / JASO FD / ISO-L-EGD

ANALYSES STANDARD TYPIQUES :

COULEUR	ROUGE	INDICE DE VISCOSITÉ	129	ALKALINITÉ, MGKOH/G	1,4
DENSITÉ À 15°C, KG/L	0,870	POINT D'ÉCLAIR PM, °C	100	SULFATE DE CENDRE, %	0,14
VISCOSITÉ 40°C, MM²/S	64,60	POINT D'ÉCLAIR COC, °C	116		
VISCOSITÉ 100°C, MM²/S	9,50	POINT D'ÉCOULEMENT, °C	-24		

HUILE MOTEUR 2 TEMPS MOTO



/ HUILE TT SPORT

476522

Bidon

1L

- Contient un colorant rouge pour être clairement visible dans le carburant
- TT Sport est une huile moteur 2 temps à combustion propre et à hautes performances
- Réduit la formation de fumée et les dépôts de carbone
- Contrebalance l'encrassement des bougies d'allumage et prolonge la durée de vie du moteur

SPÉCIFICATIONS DU PRODUIT : API TC / JASO FD / ISO-L-EGD / TISI

ANALYSES STANDARD TYPIQUES :

COULEUR	ROUGE	VISCOSITÉ 100°C, MM²/S	6,75	POINT D'ÉCOULEMENT, °C	-39
DENSITÉ À 15°C, KG/L	0,855	INDICE DE VISCOSITÉ	153	ALKALINITÉ, MGKOH/G	1,4
VISCOSITÉ 40°C, MM²/S	33,70	POINT D'ÉCLAIR COC, °C	122		



476523

Bidon

4L



500274

BIB*

20L



/ HUILE TTX 100% SYNTHÈSE

476520

Bidon

1L

TTX est une huile 100% synthèse 2 temps, développée spécialement pour la conduite sur circuit. Celle-ci est recommandée pour les moteurs routiers de hautes performances. TTX a une composition unique à faible dégagement de fumée. Elle permet de réduire les dépôts de calamine, de garantir une combustion ultra propre et de protéger toutes les pièces de moteur, même en cas de conditions extrêmes.

SPÉCIFICATIONS DU PRODUIT : API TC+/JASO FD (LOW SMOKE) / ISO-L-EGD/ PIAGGIO HEXAGON / TISI

ANALYSES STANDARD TYPIQUES :

COULEUR	ROUGE	VISCOSITÉ 100°C, MM²/S	8,90	POINT D'ÉCOULEMENT, °C	-45
DENSITÉ À 15°C, KG/L	0,873	INDICE DE VISCOSITÉ	168	ALKALINITÉ, MGKOH/G	2,9
VISCOSITÉ 40°C, MM²/S	48,00	POINT D'ÉCLAIR PM, °C	88		

HUILE MOTEUR 2 TEMPS MOTO



/ HUILE MOTO TT TRIAL PRO 100 % SYNTHÈSE

TT Trial Pro Scented est une huile 2 temps synthétique.

Le système d'additifs unique fournit les propriétés suivantes :

- Combustion plus propre et plus efficace
- Protection exceptionnelle du moteur
- Stabilité à haute température
- Résistance exceptionnelle du film et au cisaillement
- Réduit la consommation de carburant
- Pas de dépôts sur les segments de piston et le système d'échappement
- Excellente réaction du papillon des gaz (tiroir d'accélérateur), même dans des conditions humides
- Performances optimales du moteur à long terme
- Fiabilité maximale du moteur
- Optimisation du démarrage

497056

Bidon

1L

SPÉCIFICATIONS DU PRODUIT : API TC / JASO FD / TISI

ANALYSES STANDARD TYPIQUES :

COULEUR	BLEUE	VISCOSITÉ 100°C, MM ² /S	6,75	POINT D'ÉCOULEMENT, °C	-39
DENSITÉ À 15°C, KG/L	0,855	INDICE DE VISCOSITÉ	153	ALKALINITÉ, MGKOH/G	1,4
VISCOSITÉ 40°C, MM ² /S	33,70	POINT D'ÉCLAIR COC, °C	122		



/ HUILE ESTER TECH RS 959 100% SYNTHÈSE

- Protection exceptionnelle du moteur
- Ester Tech RS 959 est une huile moteur entièrement synthétique avec des additifs Ester Tech révolutionnaires
- Contient un colorant rouge et peut être clairement visible dans le carburant
- Garantit une résistance du film et une absorption de la pression, même dans les conditions de course les plus extrêmes
- Ester Tech RS 959 est particulièrement adaptée pour les moteurs à pré-mélange ou à injection 2 temps qui fonctionnent dans des conditions de course extrêmement difficiles
- Proportion recommandée : 2-4 %

476715

Bidon

1L

SPÉCIFICATIONS DU PRODUIT : API API / JASO FD / ISO-L-EGD / PIAGGIO HEXAGON

ANALYSES STANDARD TYPIQUES :

COULEUR	ROUGE	VISCOSITÉ 100°C, MM ² /S	8,80	POINT D'ÉCOULEMENT, °C	-36
DENSITÉ À 15°C, KG/L	0,871	INDICE DE VISCOSITÉ	167	ALKALINITÉ, MGKOH/G	6,6
VISCOSITÉ 40°C, MM ² /S	44,00	POINT D'ÉCLAIR PM, °C	78		



/ HUILE MX5 SPÉCIALE ENDURO SYNTHÉTIQUE

- Contient un colorant rouge pour être clairement visible dans le carburant
- MX5 est une huile entièrement synthétique haut de gamme pour moteur 2 temps tout-terrain
- Recommandée pour un usage Motocross et Enduro et testée sur les circuits du monde entier
- Grâce à sa composition synthétique et à son système d'additifs d'avant-garde, l'huile MX5 fournit une protection optimale à toutes les pièces vitales du moteur
- Évite la formation de dépôts de carbone nuisibles aux pistons, cylindres et systèmes de soupapes, tout en fournissant un film de protection durable dans toutes les conditions

484799

Bidon

1L

SPÉCIFICATIONS DU PRODUIT : API TC / JASO FD

ANALYSES STANDARD TYPIQUES :

COULEUR	BLEUE	INDICE DE VISCOSITÉ	153
DENSITÉ À 15°C, KG/L	0,855	POINT D'ÉCLAIR COC, °C	122
VISCOSITÉ 40°C, MM ² /S	33,70	POINT D'ÉCOULEMENT, °C	-39
VISCOSITÉ 100°C, MM ² /S	6,75		



526122

BIB*

20L

HUILE MOTEUR 2 TEMPS MOTO

MOTEUR

CYCLE

PNEUMATIQUE

ATELIER

ACCESSOIRES

ÉLECTRICITÉ

FILTRATION

FREINAGE

TRANSMISSION



/ HUILE MX7 SPÉCIALE CROSS 100% SYNTHÈSE

MX 7 est une huile entièrement synthétique pour moteur 2 temps tout-terrain. Le système d'additifs de MX 7 fournit les propriétés suivantes :

- Plus de puissance
- Une combustion plus propre et plus efficace
- Une protection exceptionnelle du moteur
- Un régime élevé et une grande stabilité de température
- Une résistance exceptionnelle du film d'huile
- Une réduction de la consommation de carburant
- Aucune accumulation de dépôts
- Une optimisation de l'accélérateur, même dans des conditions d'humidité importante
- Une performance et une fiabilité optimale du moteur
- Une optimisation des caractéristiques de démarrage

484800

Bidon

1L

SPÉCIFICATIONS DU PRODUIT : API TC / JASO FD/ PIAGGIO HEXAGON

ANALYSES STANDARD TYPIQUES :

COULEUR	BLEUE	INDICE DE VISCOSITÉ	185
DENSITÉ À 15°C, KG/L	0,880	POINT D'ÉCLAIR PM, °C	78
VISCOSITÉ 40°C, MM²/S	44,00	POINT D'ÉCOULEMENT, °C	-48
VISCOSITÉ 100°C, MM²/S	8,80	SULFATE DE CENDRE, %	0,26



526123

BIB*

20L



/ HUILE MX9 ESTER TECH 100% SYNTHÈSE

Ester Tech MX9 est une huile 2 temps, entièrement synthétique. L'ajout d'additifs Ester Tech garantit une lubrification sûre, même dans des conditions extrêmes de course. Ce produit a été exclusivement développé pour les motos de Grand Prix tout-terrain.

486825

Bidon

1L

SPÉCIFICATIONS DU PRODUIT : API TC / JASO FD / HUSQVARNA / ISO-L-EGD

ANALYSES STANDARD TYPIQUES :

COULEUR	BLEUE	POINT D'ÉCLAIR PM, °C	78
DENSITÉ À 15°C, KG/L	0,880	POINT D'ÉCOULEMENT, °C	-48
VISCOSITÉ 40°C, MM²/S	44,00	ALKALINITÉ, MGKOH/G	6,6
VISCOSITÉ 100°C, MM²/S	8,80	SULFATE DE CENDRE, %	0,26
INDICE DE VISCOSITÉ	185		



526125

BIB*

20L



/ HUILE SCOOTER 4T 5W-40 SYNTHÉTIQUE

Technomoto Scooter 4T 5W-40 est une huile moteur 4 temps synthétique. Sa formule unique procure une protection qui est nécessaire pour les conditions de conduite Marche/Arrêt du trafic urbain. Technomoto Scooter 4T 5W-40 a été créée exclusivement pour les scooters modernes 4 temps.

476532

Bidon

1L

SPÉCIFICATIONS DU PRODUIT : JASO MB / API SN / ACEA A3 / B4

ANALYSES STANDARD TYPIQUES :

DENSITÉ À 15°C, KG/L	0,853	VISCOSITÉ 100°C, MM²/S	14,40	POINT D'ÉCOULEMENT, °C	-36
VISCOSITÉ -25°C, MPA.S	6110	INDICE DE VISCOSITÉ	172	ALKALINITÉ, MGKOH/G	10,3
VISCOSITÉ 40°C, MM²/S	8740	POINT D'ÉCLAIR COC, °C	223		



500272

BIB*

20L



477375

Fût

60L

HUILE MOTEUR 4 TEMPS SCOOTER



/ HUILE SCOOTER 4T 10W-40 SYNTHÉTIQUE

476530

Scooter 4T 10W-40 est une huile conçue pour les moteurs 4 temps. Elle contient une huile de base spécialement sélectionnée et combinée à des additifs synthétiques modernes. Scooter 4T 10W-40 garantit ainsi un effet de nettoyage et un niveau de performance supérieurs, quelque soit le niveau de température.

Bidon

1L

SPÉCIFICATIONS DU PRODUIT : JASO MB / API SN ACEA A3 / B4

ANALYSES STANDARD TYPIQUES :

DENSITÉ À 15°C, KG/L	0,860	VISCOSITÉ 100°C, MM ² /S	13,70	POINT D'ÉCOULEMENT, °C	-39
VISCOSITÉ -25°C, MPA.S	4930	INDICE DE VISCOSITÉ	154	ALKALINITÉ, MGKOH/G	10,4
VISCOSITÉ 40°C, MM ² /S	90,40	POINT D'ÉCLAIR COC, °C	224	SOUFRE, %	0,390



500273

BIB*

20L



496027

Fût

60L



/ HUILE SCOOTER 4T + ECO 0W-30

497093

Scooter 4T+ ECO 0W-30 est une huile 100 % synthétique pour moteurs 4 temps. Sa formule unique procure une protection indispensable des arrêts/démarrages fréquents du trafic urbain. Celle-ci a été développée exclusivement pour les scooters modernes à 4 temps, qui répondent aux exigences des dernières normes Euro 4 en matière de gaz d'échappement. Sa très faible viscosité et l'utilisation d'additifs de dernière génération, permettent d'économiser du carburant.

Bidon

1L

SPÉCIFICATIONS DU PRODUIT : VW 503.00 / 506.00 / 506.01

ANALYSES STANDARD TYPIQUES :

DENSITÉ À 15°C, KG/L	0,857	POINT D'ÉCOULEMENT, °C	-51
VISCOSITÉ -35°C, MPA.S	5360	ALKALINITÉ, MGKOH/G	10,2
VISCOSITÉ 40°C, MM ² /S	53,00	INDICE D'ACIDE, MGKOH/G	3,37
VISCOSITÉ 100°C, MM ² /S	9,60	SULFATE DE CENDRE, %	1,28
INDICE DE VISCOSITÉ	168	NOACK, %	9,5
POINT D'ÉCLAIR COC, °C	226		



500270

BIB*

20L



/ HUILE SCOOTER 4T 10W-30

505019

Scooter 4T 10W-30 est une huile semi-synthétique pour moteurs 4 temps de scooter. La dernière génération d'additifs garantit une protection optimale du moteur contre l'usure, ainsi que ceux qui disposent d'un système 'start/stop'. Cette huile a été conçue pour économiser efficacement du carburant, notamment pour la dernière génération de scooters 4 temps. Elle garantit :

- Une très faible consommation d'huile
- D'excellentes propriétés de viscosité même à basse température, pour éviter l'usure lors du démarrage à froid
- D'excellentes propriétés de nettoyage qui garantissent des performances optimales et durables du moteur
- Une excellente lubrification pendant toute la durée de vie du moteur

Bidon

1L

SPÉCIFICATIONS DU PRODUIT : JASO MB / API SN / ACEA A3/B4

ANALYSES STANDARD TYPIQUES :

DENSITÉ À 15°C, KG/L	0,861	VISCOSITÉ 100°C, MM ² /S	11,50	POINT D'ÉCOULEMENT, °C	-39
VISCOSITÉ -25°C, MPA.S	4130	INDICE DE VISCOSITÉ	156	ALKALINITÉ, MGKOH/G	10,3
VISCOSITÉ 40°C, MM ² /S	71,10	POINT D'ÉCLAIR COC, °C	220		

HUILE MOTEUR 4 TEMPS MOTO

/ GAMME N-TECH® PRO-R 4+

Créée par Putoline Oil, la gamme N-TECH® PRO-R 4+ est une huile 100 % synthétique pour moteur 4 temps, la plus à la pointe. Grâce aux huiles N-TECH, la compatibilité des matériaux modernes de friction d'embrayage est totale. La prise en main de l'embrayage est inégalée.

Propriétés :

- Moteur et transmission très bien protégés contre l'usure
- Performance maximale et constante du moteur
- Convient particulièrement aux motos tout-terrain qui roulent dans des conditions difficiles
- Très faible consommation d'huile et une excellente fluidité, même à basses températures
- Très bonne capacité de nettoyage, de haute qualité, pendant toute la durée de vie
- Contient les additifs Pure Bike Nano Tech



/ 5W-40

SPÉCIFICATIONS DU PRODUIT : JASO MA-2 / API SM

ANALYSES STANDARD TYPQUES :

COULEUR	BLEUE	VISCOSITÉ 40°C, MM²/S	85,60	POINT D'ÉCLAIR COC, °C	234
DENSITÉ À 15°C, KG/L	0,855	VISCOSITÉ 100°C, MM²/S	14,00	POINT D'ÉCOULEMENT, °C	-39
VISCOSITÉ -30°C, MPA.S	6460	INDICE DE VISCOSITÉ	170	ALKALINITÉ, MGKOH/G	8,4

493116

Bidon

1L



486692

Bidon

4L



526120

BIB*

20L



/ 10W-30

SPÉCIFICATIONS DU PRODUIT : JASO MA-2 / API SM

ANALYSES STANDARD TYPQUES :

COULEUR	BLEUE	VISCOSITÉ 40°C, MM²/S	66,80	POINT D'ÉCLAIR COC, °C	207
DENSITÉ À 15°C, KG/L	0,848	VISCOSITÉ 100°C, MM²/S	11,50	POINT D'ÉCOULEMENT, °C	-39
VISCOSITÉ -25°C, MPA.S	3000	INDICE DE VISCOSITÉ	168	ALKALINITÉ, MGKOH/G	8,4

493119

Bidon

1L

/ 10W-40

SPÉCIFICATIONS DU PRODUIT : JASO MA-2 / API SM

ANALYSES STANDARD TYPQUES :

COULEUR	BLEUE	VISCOSITÉ 40°C, MM²/S	93,40	POINT D'ÉCLAIR COC, °C	228
DENSITÉ À 15°C, KG/L	0,855	VISCOSITÉ 100°C, MM²/S	14,50	POINT D'ÉCOULEMENT, °C	-36
VISCOSITÉ -25°C, MPA.S	5140	INDICE DE VISCOSITÉ	161	ALKALINITÉ, MGKOH/G	8,4

492722

Bidon

1L



492723

Bidon

4L



500268

BIB*

20L

HUILE MOTEUR 4 TEMPS MOTO



/ 10W-50

492720

SPÉCIFICATIONS DU PRODUIT : JASO MA-2 / API SM

Bidon

1L

ANALYSES STANDARD TYPIQUES :

DENSITÉ À 15°C, KG/L	0,857	VISCOSITÉ 100°C, MM²/S	18,80	POINT D'ÉCOULEMENT, °C	-33
VISCOSITÉ -25°C, MPA.S	4270	INDICE DE VISCOSITÉ	172	ALKALINITÉ, MGKOH/G	76
VISCOSITÉ 40°C, MM²/S	123,00	POINT D'ÉCLAIR COC, °C	234	CENDRES SULFATÉES, %	0,85



492721

Bidon

4L



326017

BIB*

20L

/ HUILE GAMME N-TECH® PRO-R OFF ROAD 4+

Créée par Putoline Oil, N-TECH® PRO-R OFF ROAD 4+ est l'huile 100 % synthétique la plus à la pointe pour moteur 4 temps. Grâce aux huiles-ano Tech, la compatibilité des matériaux modernes de friction d'embrayage est totale. La prise en main de l'embrayage est inégalée.

Propriétés :

- Moteur et transmission très bien protégés contre l'usure
- Très faible consommation d'huile
- Excellente fluidité, même à basses températures
- Performance maximale et constante du moteur
- Très bonne capacité de nettoyage, de haute qualité, pendant toute la durée de vie
- Contient les additifs Pure Bike Nano Tech
- Cette huile moteur 100 % synthétique 4 temps convient particulièrement aux motos tout-terrain qui roulent dans des conditions difficiles.



/ 10W-40

493121

SPÉCIFICATIONS DU PRODUIT : JASO MA2 / API SM

Bidon

1L

ANALYSES STANDARD TYPIQUES :

DENSITÉ À 15°C, KG/L	0,855	POINT D'ÉCLAIR COC, °C	228
VISCOSITÉ -25°C, MPA.S	5140	POINT D'ÉCOULEMENT, °C	-36
VISCOSITÉ 40°C, MM²/S	93,40	ALKALINITÉ, MGKOH/G	8,4
VISCOSITÉ 100°C, MM²/S	14,50		
INDICE DE VISCOSITÉ	161		



/ 10W-50

493120

SPÉCIFICATIONS DU PRODUIT : API SM / JASO MA2

Bidon

1L

ANALYSES STANDARD TYPIQUES :

DENSITÉ À 15°C, KG/L	0,858	INDICE DE VISCOSITÉ	165
VISCOSITÉ -25°C, MPA.S	3330	POINT D'ÉCLAIR COC, °C	228
VISCOSITÉ 40°C, MM²/S	116,20	POINT D'ÉCOULEMENT, °C	-36
VISCOSITÉ 100°C, MM²/S	1740	ALKALINITÉ, MGKOH/G	8,4

HUILE MOTEUR 4 TEMPS MOTO



/ 10W-60

494123

SPÉCIFICATIONS DU PRODUIT : JASO MA-2 / API SM

Bidon

1L

ANALYSES STANDARD TYPIQUES :

COULEUR	BLEUE	INDICE DE VISCOSITÉ	170
DENSITÉ À 15°C, KG/L	0,857	POINT D'ÉCLAIR COC, °C	238
VISCOSITÉ -25°C, MPA.S	6760	POINT D'ÉCOULEMENT, °C	-36
VISCOSITÉ 40°C, MM²/S	163,00	ALKALINITÉ, MGKOH/G	8,4
VISCOSITÉ 100°C, MM²/S	22,80		

/ HUILE GAMME OFF ROAD 4

OFF ROAD 4 10W-40 est une huile moteur 4 temps semi-synthétique. Elle garantit une compatibilité totale avec les matériaux modernes de friction d'embrayage. Cette huile a été exclusivement créée pour une utilisation tout-terrain.



/ 10W-40

486701

SPÉCIFICATIONS DU PRODUIT : JASO MA-2 / API SM

Bidon

1L

ANALYSES STANDARD TYPIQUES :

DENSITÉ À 15°C, KG/L	0,863	INDICE DE VISCOSITÉ	153
VISCOSITÉ -25°C, MPA.S	4580	POINT D'ÉCOULEMENT, °C	222
VISCOSITÉ 40°C, MM²/S	87,80	ALKALINITÉ, MGKOH/G	-33
VISCOSITÉ 100°C, MM²/S	13,90	NOACK, %	7,6

/ HUILE GAMME ESTER TECH OFF ROAD 4+

ESTER TECH OFF ROAD 4+ est une huile entièrement synthétique pour moteur 4 temps de compétition. Les additifs révolutionnaires Ester Tech garantissent une compatibilité totale avec les matériaux modernes de friction d'embrayage. Cette huile a été créée exclusivement pour les motos tout-terrain. Elle augmente la durée de vie du moteur, même dans des conditions de course difficiles.



/ 10W-40

486705

SPÉCIFICATIONS DU PRODUIT : JASO MA-2 / API SM

Bidon

1L

ANALYSES STANDARD TYPIQUES :

DENSITÉ À 15°C, KG/L	0,853	INDICE DE VISCOSITÉ	163
VISCOSITÉ -25°C, MPA.S	3370	POINT D'ÉCOULEMENT, °C	-33
VISCOSITÉ 40°C, MM²/S	83,60	ALKALINITÉ, MGKOH/G	7,6
VISCOSITÉ 100°C, MM²/S	13,60	NOACK, %	6,5

HUILE MOTEUR 4 TEMPS MOTO



/ 10W-50

SPÉCIFICATIONS DU PRODUIT : JASO MA-2 / API SM

ANALYSES STANDARD TYPIQUES :

DENSITÉ À 15°C, KG/L	0,852	INDICE DE VISCOSITÉ	172
VISCOSITÉ -25°C, MPA.S	4160	POINT D'ÉCLAIR COC, °C	236
VISCOSITÉ 40°C, MM²/S	124,0	ALKALINITÉ, MGKOH/G	76
VISCOSITÉ 100°C, MM²/S	18,00	NOACK, %	5,7

486707

Bidon

1L



/ 10W-60

SPÉCIFICATIONS DU PRODUIT : JASO MA-2 / API SM

ANALYSES STANDARD TYPIQUES :

DENSITÉ À 15°C, KG/L	0,858	INDICE DE VISCOSITÉ	175
VISCOSITÉ -25°C, MPA.S	5550	POINT D'ÉCOULEMENT, °C	-30
VISCOSITÉ 40°C, MM²/S	166,0	ALKALINITÉ, MGKOH/G	76
VISCOSITÉ 100°C, MM²/S	23,90	NOACK, %	7,7

486709

Bidon

1L

/ HUILE ESTER TECH SYNTEC 4+

ESTER TECH SYNTEC 4+ est une huile 100 % synthétique pour moteur de compétition 4 temps.

Les huiles haut de gamme combinées aux additifs révolutionnaires Ester Tech, assurent des performances exceptionnelles :

- Film lubrifiant très puissant, même dans les conditions les plus extrêmes
- Performance maximale du moteur
- Indice de viscosité très élevé et extrêmement stable
- Fonctionnement optimal de l'embrayage à huile
- Changement de rapport précis et souple
- Protection supérieure contre l'usure
- Baisse de la consommation d'huile grâce à une faible volatilité
- Ester Tech Syntec 4+ a été créée exclusivement pour les motos de route et de course modernes, high-tech, aux performances élevées



/ 10W-40

SPÉCIFICATIONS DU PRODUIT : JASO MA-2 / API SM

ANALYSES STANDARD TYPIQUES :

DENSITÉ À 15°C, KG/L	0,853	VISCOSITÉ 100°C, MM²/S	18,90	POINT D'ÉCOULEMENT, °C	-33
VISCOSITÉ -25°C, MPA.S	3370	INDICE DE VISCOSITÉ	163	ALKALINITÉ, MGKOH/G	76
VISCOSITÉ 40°C, MM²/S	83,60	POINT D'ÉCLAIR COC, °C	236	NOACK, %	6,5

486716

Bidon

1L



486718

Bidon

1L



526121

BIB*

20L

HUILE MOTEUR 4 TEMPS MOTO



/ 10W-50

486690

SPÉCIFICATIONS DU PRODUIT : JASO MA-2 / API SM

Bidon

1L

ANALYSES STANDARD TYPIQUES :

DENSITÉ À 15°C, KG/L	0,853	POINT D'ÉCLAIR COC, °C	236
VISCOSITÉ -25°C, MPA.S	3370	POINT D'ÉCOULEMENT, °C	-33
VISCOSITÉ 40°C, MM²/S	83,60	ALKALINITÉ, MGKOH/G	7,6
VISCOSITÉ 100°C, MM²/S	13,60	NOACK, %	6,5
INDICE DE VISCOSITÉ	163		

/ HUILE GAMME SPORT 4R

SPORT 4R est une huile moteur 4 temps semi-synthétique.

Elle contient le système d'additifs révolutionnaire Pure Bike Technomoto et garantit une compatibilité totale avec les matériaux de friction d'embrayage modernes. Technomoto Sport 4 a été exclusivement créée pour les motos sportives et de tourisme.



/ 10W-40

477376

SPÉCIFICATIONS DU PRODUIT : JASO MA-2 / API SM

Bidon

1L

ANALYSES STANDARD TYPIQUES :

DENSITÉ À 15°C, KG/L	0,863	VISCOSITÉ 100°C, MM²/S	13,90	POINT D'ÉCOULEMENT, °C	-33
VISCOSITÉ -25°C, MPA.S	4580	INDICE DE VISCOSITÉ	153	ALKALINITÉ, MGKOH/G	7,6
VISCOSITÉ 40°C, MM²/S	8780	POINT D'ÉCLAIR COC, °C	222	CENDRES SULFATÉES, %	0,85



478989

Bidon

4L



500269

BIB*

20L



481360

Fût

60L



/ 15W-50

486731

SPÉCIFICATIONS DU PRODUIT : JASO MA-2 / API SM

Bidon

1L

ANALYSES STANDARD TYPIQUES :

DENSITÉ À 15°C, KG/L	0,872	VISCOSITÉ 100°C, MM²/S	1770	ALKALINITÉ, MGKOH/G	7,7
VISCOSITÉ -25°C, MPA.S	4650	INDICE DE VISCOSITÉ	153	SULFATE DE CENDRE, %	0,94
VISCOSITÉ -20°C, MPA.S	3200	POINT D'ÉCLAIR COC, °C	236	NOACK, %	10,4
VISCOSITÉ 40°C, MM²/S	128,00	POINT D'ÉCOULEMENT, °C	-33		



507568

Fût

60L

HUILE MOTEUR 4 TEMPS MOTO



/ 20W-50

SPÉCIFICATIONS DU PRODUIT : JASO MA-2 / API SM

ANALYSES STANDARD TYPQUES :

DENSITÉ À 15°C, KG/L	0,886	POINT D'ÉCLAIR COC, °C	230
VISCOSITÉ -15°C, MPA.S	5190	POINT D'ÉCOULEMENT, °C	-30
VISCOSITÉ 40°C, MM²/S	159,00	ALKALINITÉ, MGKOH/G	76
VISCOSITÉ 100°C, MM²/S	18,80	SULFATE DE CENDRE, %	0,85
INDICE DE VISCOSITÉ	134	NOACK, %	74

482575

Bidon

1L



/ HUILE GAMME S4 10W-40

S4 10W-40 est une huile moteur 4 temps semi-synthétique. Elle offre une protection totale dans des conditions de conduites normales. Elle est particulièrement adaptée pour les motos, scooters et véhicules modernes tout-terrain.

SPÉCIFICATIONS DU PRODUIT : API SG / JASO MA

ANALYSES STANDARD TYPQUES :

DENSITÉ À 15°C, KG/L	0,859	POINT D'ÉCOULEMENT, °C	-33
VISCOSITÉ -25°C, MPA.S	3200	ALKALINITÉ, MGKOH/G	7,7
VISCOSITÉ 40°C, MM²/S	85,60	SULFATE DE CENDRE, %	0,94
VISCOSITÉ 100°C, MM²/S	14,00	NOACK, %	12,2
INDICE DE VISCOSITÉ	168		
POINT D'ÉCLAIR COC, °C	218		



494119

Bidon

1L



/ HUILE GAMME GENUINE V-TWIN 20W-50

GENUINE V-TWIN 20W-50 4 temps est une huile moteur de moto de la gamme V-Twin. Sa formule unique répond aux exigences des moteurs modernes V-Twin 4-temps. Elle dépasse les attentes des principaux fabricants. Dans des conditions normales d'utilisation, celle-ci offre une protection complète du moteur.

SPÉCIFICATIONS DU PRODUIT : JASO MA-2 / API SM

ANALYSES STANDARD TYPQUES :

DENSITÉ À 15°C, KG/L	0,849	INDICE DE VISCOSITÉ	173	SULFATE DE CENDRE, %	0,94
VISCOSITÉ -15°C, MPA.S	1670	POINT D'ÉCLAIR COC, °C	218	NOACK, %	6,0
VISCOSITÉ 40°C, MM²/S	140,00	POINT D'ÉCOULEMENT, °C	-45		
VISCOSITÉ 100°C, MM²/S	20,70	ALKALINITÉ, MGKOH/G	7,7		

486693

Bidon

1L

HUILE MOTEUR 2 & 4 TEMPS



/ HUILE CASTOR R

Castor R est une huile de ricin pure, de haute qualité, combinée à des additifs spéciaux. Elle est spécialement destinée aux motos 2 et 4 temps de compétition Grass Track et Speedway. L'huile peut être mélangée avec du méthanol, du nitro-méthane et de l'essence.

SPÉCIFICATIONS DU PRODUIT : API TC / JASO FD / ISO-L-EGD

ANALYSES STANDARD TYPQUES :

DENSITÉ À 15°C, KG/L	0,960	INDICE DE VISCOSITÉ	100
VISCOSITÉ 40°C, MM²/S	250,80	POINT D'ÉCLAIR COC, °C	250
VISCOSITÉ 100°C, MM²/S	19,10	POINT D'ÉCOULEMENT, °C	-27

493118

Bidon

1L

HUILES DE BOITE/TRANSMISSION



/ HUILE DE BOITE SCOOGEAR 75W-90

SCOOTGEAR 75W-90 est une huile de transmission synthétique très moderne spécialement créée pour les scooters. Des huiles synthétiques à faible viscosité et des additifs de pointe, lui confèrent les propriétés suivantes :

- Bonnes propriétés « pression extrême » qui fournissent une protection supplémentaire contre l'usure
- Excellente résistance aux températures élevées, ce qui améliore la longévité de l'huile
- Exceptionnels changements de rapport, même à des températures extrêmement hautes ou basses
- Évite le moussage

SPÉCIFICATIONS DU PRODUIT : API GL-5

ANALYSES STANDARD TYPIQUES :

DENSITÉ À 15°C, KG/L	0,868	POINT D'ÉCLAIR COC, °C	190
VISCOSITÉ 40°C, MM²/S	80,90	POINT D'ÉCOULEMENT, °C	-45
VISCOSITÉ 100°C, MM²/S	14,80	BROOKFIELD -40°C, MPA.S	69600
INDICE DE VISCOSITÉ	192		



495342

Bidon

125 ml



/ HUILE SCOOTER GEAR SAE 30

Scooter GEAR 30 est une huile de boîte de vitesses SAE 10W-30. Elle convient aux vélomoteurs tels que les Saxonette, Tomos A3, Tomos 4L Yamaha, Puch Maxi, Sachs, Puch, Vespa, Kreidler et Zundapp.

SPÉCIFICATIONS DU PRODUIT : API GSF / CC

ANALYSES STANDARD TYPIQUES

DENSITÉ À 15°C, KG/L	0,885	POINT D'ÉCLAIR COC, °C	230
VISCOSITÉ 40°C, MM²/S	103,00	POINT D'ÉCOULEMENT, °C	-18
VISCOSITÉ 100°C, MM²/S	11,70	ALKALINITÉ, MGKOH/G	3,5
INDICE DE VISCOSITÉ	98		



486063

Bidon

500 ml



/ HUILE DE BOITE ATF DREXON III

ATF-Dexron III est une huile de transmission de qualité supérieure offrant les propriétés suivantes :

- Bonne propriétés de réduction de friction
- Haute stabilité thermique et à l'oxydation
- Garantit une longue durée de vie

ATF Dexron III convient aux boîtes de vitesses 2 temps automatiques et synchronisées, transmissions assistées, convertisseurs de couple, systèmes d'asservissement et embrayages hydrauliques. Elle a été conçue pour un usage sur route et circuit.

SPÉCIFICATIONS DU PRODUIT : GM DEXRON IID / IIE / IIIF / IIIG/ IIIH

ANALYSES STANDARD TYPIQUES :

DENSITÉ À 15°C, KG/L	0,851	INDICE DE VISCOSITÉ	175	ALKALINITÉ, MGKOH/G	1,9
VISCOSITÉ 40°C, MM²/S	37,70	POINT D'ÉCLAIR COC, °C	210		
VISCOSITÉ 100°C, MM²/S	7,60	POINT D'ÉCOULEMENT, °C	-51		

493828

Bidon

1L



/ HUILE SCOOTER LIGHT GEAR 75W

Gear Light est une huile de transmission moderne. La base synthétique, légère, protège les composants de la boîte de vitesses et garantit un changement de vitesse en douceur dans toutes les conditions et en particulier lorsque la température ambiante est faible. Gear Light a été conçue pour un usage sur route et circuit.

SPÉCIFICATIONS DU PRODUIT : API GL-1

ANALYSES STANDARD TYPIQUES :

DENSITÉ À 15°C, KG/L	0,852	POINT D'ÉCLAIR COC, °C	205
VISCOSITÉ 40°C, MM²/S	36,00	POINT D'ÉCOULEMENT, °C	-30
VISCOSITÉ 100°C, MM²/S	5,84	TAUX D'ACIDITÉ, MGKOH/G	1,10
INDICE DE VISCOSITÉ	98		



476527

Bidon

1L

500276

BIB*

20L

HUILES DE BOITE/TRANSMISSION



/ HUILE DE BOITE HEAVY GEAR 80W-90

GEAR HEAVY 80W-90 est une huile de transmission unique, contenant des additifs pour résister aux pressions extrêmes. Elle est recommandée pour des transmissions universelles.

476529

Bidon

1L

SPÉCIFICATIONS DU PRODUIT : API GL-5 / MIL-L-2105D

ANALYSES STANDARD TYPIQUES :

DENSITÉ À 15°C, KG/L	0,890	POINT D'ÉCLAIR COC, °C	230
VISCOSITÉ 40°C, MM²/S	149,00	POINT D'ÉCOULEMENT, °C	-30
VISCOSITÉ 100°C, MM²/S	14,80	TAUX D'ACIDITÉ, MGKOH/G	1,80
INDICE DE VISCOSITÉ	98	SULFATE DE CENDRE, %	0,05



500277

BIB*

20L



/ HUILE DE BOITE MEDIUM GEAR 80W

MEDIUM GEAR 80W est une huile de transmission moderne. Lors de forte chaleur, l'huile offre une excellente protection. À températures ambiantes supérieures à 20°C, le produit réduit la friction, améliorant la puissance de la roue arrière de façon optimale. MEDIUM GEAR 80W convient à été conçue pour un usage sur route et circuit.

476528

Bidon

1L

SPÉCIFICATIONS DU PRODUIT : API GL-1

ANALYSES STANDARD TYPIQUES :

DENSITÉ À 15°C, KG/L	0,888	POINT D'ÉCLAIR COC, °C	230
VISCOSITÉ 40°C, MM²/S	102,00	POINT D'ÉCOULEMENT, °C	-18
VISCOSITÉ 100°C, MM²/S	11,50	TAUX D'ACIDITÉ, MGKOH/G	1,10
INDICE DE VISCOSITÉ	98		



526141

BIB*

20L



494795

Fût

60L



/ HUILE DE BOITE RS75 75/80W

RS 75 75/80W est une huile de transmission de course. Unique et 100 % synthétique, elle contient des additifs spéciaux qui protègent des charges de cisaillement et des chocs, se produisant lors de conditions extrêmes. RS 75 75/80W a été développée exclusivement pour les motos de Grand Prix 2 et 4 temps.

486759

Litre

1L

SPÉCIFICATIONS DU PRODUIT : API GL-4/5

ANALYSES STANDARD TYPIQUES :

DENSITÉ À 15°C, KG/L	0,849	POINT D'ÉCLAIR COC, °C	194
VISCOSITÉ 40°C, MM²/S	38,30	POINT D'ÉCOULEMENT, °C	-60
VISCOSITÉ 100°C, MM²/S	7,31	BROOKFIELD -40°C, MPA.S	8850
INDICE DE VISCOSITÉ	159		

HUILES DE FOURCHE

/ HUILE GAMME FOURCHE MEDIUM FORK

MEDIUM FORK est une huile de fourche minérale destinée à une utilisation sur route normale. Elle convient aux scooters et cyclomoteurs avec fourche classique ou inversée.



/ 5W

492717

Bidon

ANALYSES STANDARD TYPIQUES :

DENSITÉ À 15°C, KG/L	0,867	POINT D'ÉCOULEMENT, °C	-51
VISCOSITÉ 40°C, MM²/S	15,00	TAUX D'ACIDITÉ, MGKOH/G	0,40
VISCOSITÉ 100°C, MM²/S	3,40	CENDRES SULFATÉES, %	0,06
POINT D'ÉCLAIR COC, °C	175		

500 ml



/ 10W

492718

Bidon

ANALYSES STANDARD TYPIQUES :

DENSITÉ À 15°C, KG/L	0,850	TAUX D'ACIDITÉ, MGKOH/G	0,40
VISCOSITÉ 40°C, MM²/S	32,00	CENDRES SULFATÉES, %	0,06
VISCOSITÉ 100°C, MM²/S	5,52		
POINT D'ÉCLAIR COC, °C	205		
POINT D'ÉCOULEMENT, °C	-30		

500 ml



/ 20W

492719

Bidon

ANALYSES STANDARD TYPIQUES :

DENSITÉ À 15°C, KG/L	0,882	INDICE DE VISCOSITÉ	102
VISCOSITÉ 40°C, MM²/S	68,00	POINT D'ÉCLAIR COC, °C	220
VISCOSITÉ 100°C, MM²/S	8,80	POINT D'ÉCOULEMENT, °C	-24

500 ml

/ HUILE DE FOURCHE GPR6



/ 3.5W

507532

Bidon

GPR 6 3.5W est une huile d'amortisseur spécialement créée pour la compétition. L'ajout d'additifs spéciaux donne au produit les propriétés suivantes :

- Lubrification inégale
- Réduit la friction
- Sensation plus directe entre le pneu et la surface de la route
- Neutralise la formation de mousse
- Viscosité très stable
- Empêche la perte d'absorption

1L

ANALYSES STANDARD TYPIQUES :

DENSITÉ À 15°C, KG/L	0,840	INDICE DE VISCOSITÉ	458
VISCOSITÉ 40°C, MM²/S	6,74	POINT D'ÉCLAIR PM, °C	87
VISCOSITÉ 100°C, MM²/S	3,01	POINT D'ÉCOULEMENT, °C	-33



505679

BIB*

20L

HUILES DE FOURCHE

/ HUILE DE FOURCHE HPX R

HPX R est une huile de fourche de pointe. Elle est élaborée à partir d'huiles synthétiques uniques, hautement raffinées. Grâce aux additifs les plus à la pointe du progrès, HPX R est une huile de haute technologie, utilisée lors du Grand Prix. Elle évite ainsi la corrosion, l'oxydation, les fuites des joints et le moussage. Celle-ci est particulièrement adaptée pour les motos de Grand Prix, en Enduro Cross, sur piste, sur route et hors route.



/ 2.5W

ANALYSES STANDARD TYPQUES :

DENSITÉ À 15°C, KG/L	0,840	INDICE DE VISCOSITÉ	458
VISCOSITÉ 40°C, MM²/S	6,74	POINT D'ÉCLAIR PM, °C	87
VISCOSITÉ 100°C, MM²/S	3,01	POINT D'ÉCOULEMENT, °C	-33

486751

Bidon

1L



/ 5W

ANALYSES STANDARD TYPQUES :

DENSITÉ À 15°C, KG/L	0,877	INDICE DE VISCOSITÉ	162
VISCOSITÉ 20°C, MM²/S	49,60	POINT D'ÉCLAIR COC, °C	174
VISCOSITÉ 40°C, MM²/S	22,50	POINT D'ÉCOULEMENT, °C	-51
VISCOSITÉ 100°C, MM²/S	5,07		

476538

Bidon

1L



512759

BIB*

20L



/ 7.5W

ANALYSES STANDARD TYPQUES :

DENSITÉ À 15°C, KG/L	0,896	VISCOSITÉ 100°C, MM²/S	6,31
VISCOSITÉ 20°C, MM²/S	76,60	INDICE DE VISCOSITÉ	151
VISCOSITÉ 40°C, MM²/S	32,10	POINT D'ÉCOULEMENT, °C	-51

486753

Bidon

1L



512760

BIB*

20L



/ 10W

ANALYSES STANDARD TYPQUES :

DENSITÉ À 15°C, KG/L	0,880	INDICE DE VISCOSITÉ	151
VISCOSITÉ 20°C, MM²/S	128,00	POINT D'ÉCLAIR COC, °C	204
VISCOSITÉ 40°C, MM²/S	50,10	POINT D'ÉCOULEMENT, °C	-39
VISCOSITÉ 100°C, MM²/S	8,64		

476539

Bidon

1L



512761

BIB*

20L

HUILES DE FOURCHE



/ 15W

ANALYSES STANDARD TYPIQUES :

DENSITÉ À 15°C, KG/L	0,878	INDICE DE VISCOSITÉ	165
VISCOSITÉ 20°C, MM²/S	169,00	POINT D'ÉCLAIR COC, °C	225
VISCOSITÉ 40°C, MM²/S	66,80	POINT D'ÉCOULEMENT, °C	-33
VISCOSITÉ 100°C, MM²/S	11,40		

487030

Bidon

1L



521169

BIB*

20L



/ 20W

ANALYSES STANDARD TYPIQUES :

DENSITÉ À 15°C, KG/L	0,887	INDICE DE VISCOSITÉ	155
VISCOSITÉ 20°C, MM²/S	269,80	POINT D'ÉCLAIR COC, °C	234
VISCOSITÉ 40°C, MM²/S	99,40	POINT D'ÉCOULEMENT, °C	-33
VISCOSITÉ 100°C, MM²/S	14,80		

476540

Bidon

1L

LIQUIDES DE REFROIDISSEMENT



/ LIQUIDE DE REFROIDISSEMENT COOLANT -38 ORGANIC NF

Coolant NF est un liquide de refroidissement organique prêt à l'emploi.

Des additifs anti-corrosion assurent une excellente protection de tous les métaux présents dans les moteurs, y compris l'aluminium et le magnésium. Le produit offre une excellente protection contre le gel, jusqu'à -38°C. Coolant NF convient aux motos de route et tout-terrain, les quads, scooters, karts et motoneiges.

SPÉCIFICATIONS DU PRODUIT : MB 326.3 - OPEL / GM 6277M /
FORD WSS-M97B44-D / VW TL-774F

ANALYSES STANDARD TYPIQUES :

COULEUR	JAUNE
DENSITÉ À 15°C, KG/L	1,080
POINT D'ÉCLAIR COC, °C	111

476549

Bidon

1L



500278

BIB*

20L



/ LIQUIDE DE REFROIDISSEMENT ULTRACOOOL 12

Ultracool 12, de couleur Rose, est un liquide de refroidissement longue durée prêt à l'emploi.

De qualité haut de gamme (protection contre le gel jusqu'à -40°C), celui-ci est basé sur une technologie brevetée sans silicates, à base d'acides carboxyliques. Ce liquide a été spécialement créé pour des systèmes de refroidissement en aluminium, cuivre ou alliages d'aluminium. Ultracool 12 peut également être utilisé en toute sécurité, dans les systèmes de refroidissement classiques en fonte. Grâce aux puissants inhibiteurs de corrosion, ce liquide ne vieillit presque pas et peut être utilisé pendant toute la durée de vie du moteur. Pour de meilleurs résultats, il est conseillé de le remplir à 100%.

SPÉCIFICATIONS DU PRODUIT : ASTM D3306 / D4985 / D6210

ANALYSES STANDARD TYPIQUES :

DENSITÉ À 15°C, KG/L	1,045
TEMPÉRATURE DE CONGÉLATION, °C	-38

501200

Bidon

1L



526137

BIB*

20L

MAINTENANCE PNEU



PÂTE A PNEU SPÉCIALE MONTAGE PNEU TYRE FITTING LUBE

505020

Tyre Fitting Lube peut être utilisé pour (dé)monter des pneus. Il empêche le caoutchouc de se déchirer et l'étirement du talon du pneu. L'effet glissant étant prononcé, celui-ci diminue la pression et évite le détachement du pneu. Détenant d'excellentes propriétés de glissement et de pénétration, il peut être utilisé dans des endroits difficiles d'accès. Invisible, économique à l'emploi, ce produit ne contient pas de silicone.

Aérosol

500 ml

Mode d'emploi :

- Secouer avant usage
- S'assurer que la température des pneus soit d'au moins 15°C lors du montage
- Appliquer le produit sur le talon du pneu et le rebord de jante
- Étaler le produit avec un chiffon non pelucheux
- (Dé)monter ensuite le pneu

MAINTENANCE FREIN



LIQUIDE DE FREIN DRAULIQUID 5 DOT4

476557

DOT 4 Brake Fluid est un liquide de frein synthétique haut de gamme qui dépasse les exigences des constructeurs de motos.

Bidon

250 ml

Mode d'emploi :

- Remplacer le liquide de frein tous les deux ans pour continuer à garantir un bon fonctionnement
- N'utiliser que DOT 4 Brake Fluid lorsque c'est spécifié
- Consulter le manuel d'utilisation pour obtenir les spécifications nécessaires
- Peut être mélangé avec les liquides de frein synthétiques DOT 3 et DOT 5.1®

SPÉCIFICATIONS DU PRODUIT : FMVSS 116 DOT 4 / SAE J1703, ISO 4925

ANALYSES STANDARD TYPQUES :

DENSITÉ À 15°C, KG/L	1,030	POINT D'ÉBULLITION (REFLUX), °C	263
VISCOSITÉ -40°C, MM²/S	1200	POINT D'ÉBULLITION HUMIDE, °C	168
VISCOSITÉ 100°C, MM²/S	2,30	PH - 50% DANS SOLUTION D'ÉTHANOL	8,00
POINT D'ÉCLAIR PM, °C	91		



486773

Bidon

500 ml

LIQUIDE FREIN DOT 5.1 BRAKE FLUID

494914

Le liquide de freinage DOT 5.1 est un fluide synthétique de haute qualité qui dépasse les exigences des fabricants de motos.

Bidon

500 ml

Instructions d'utilisation :

- Remplacer le liquide de frein tous les deux ans pour continuer à garantir un bon fonctionnement
- Utiliser uniquement le fluide de frein DOT 5.1 lorsque c'est spécifié
- Consulter le manuel d'utilisation pour les spécifications nécessaires
- Peut être mélangé avec du DOT 3 et DOT 4 synthétiques

SPÉCIFICATIONS DU PRODUIT : FMVSS 116 DOT 5.1 / SAE J1703, ISO 4925 / SAE J1703, ISO 4925

ANALYSES STANDARD TYPQUES :

DENSITÉ À 15°C, KG/L	1,070	VISCOSITÉ 100°C, MM²/S	1,70	POINT D'ÉBULLITION HUMIDE, °C	263
DENSITÉ À 20°C, KG/L	1,052	POINT D'ÉCLAIR PM, °C	150	POINT D'ÉBULLITION HUMIDE, °C	190
VISCOSITÉ -40°C, MM²/S	850	POINT D'ÉBULLITION (REFLUX), °C			

MAINTENANCE FREIN



LIQUIDE/HUILE D'EMBRAYAGE HYDRAULIC CLUTCH FLUID

Hydraulic Clutch Fluid est un fluide d'embrayage minéral. Il protège contre l'usure et l'oxydation. Hydraulic Clutch Fluid convient aux produits de marque Magura, ainsi qu'à d'autres marques.

495339

Bidon

125 ml

SPÉCIFICATIONS DU PRODUIT : DIN 51524-3 HVLPD

ANALYSES STANDARD TYPIQUES :

DENSITÉ À 15°C, KG/L	0,848	INDICE DE VISCOSITÉ	207
VISCOSITÉ 40°C, MM²/S	10,20	POINT D'ÉCLAIR COC, °C	130
VISCOSITÉ 100°C, MM²/S	3,19	POINT D'ÉCOULEMENT, °C	-57

MAINTENANCE CHAÎNE



GRAISSE CHAÎNE DX 11 CHAIN SPRAY

DX11 Chain Spray est un lubrifiant de chaîne synthétique. Sa formule unique, hydrofuge, pénètre profondément dans les maillons de la chaîne et dépose une couche protectrice. DX11 adhère très bien et reste en place longtemps. Il offre une protection parfaite contre la corrosion et l'usure, réduit la friction et n'est pas salissant. DX11 Chain Spray est adapté pour des niveaux élevés de performance sur les chaînes ouvertes, à joints toriques et en O-/X-/Z des motos de route et tout-terrain.

506204

Aérosol

75 ml



GRAISSE CHAÎNE TECH CHAIN

Tech Chain (Ceramic Wax) est un lubrifiant de chaîne moderne haut de gamme. Le produit est composé d'une formule de cire unique combinée avec des additifs sophistiqués, y compris du PTFE. Tech Chain offre une protection optimale de la chaîne dans toutes les conditions de fonctionnement. Convient pour une utilisation sportive et professionnelle à la fois sur le joint torique et les chaînes MX.

506205

Aérosol

75 ml



GRAISSE CHAÎNE O/X RING

O/X-Ring Chainspray est un lubrifiant unique pour chaînes. Sa formule spécifique offre une importante résistance aux températures élevées. Ses propriétés de pénétration et d'hydrofuge favorisent la lubrification de tous les points rotatifs et difficiles d'accès. O/X-Ring Chainspray a été créé pour des chaînes ordinaires et à joints toriques en X. Bien secouer avant usage.

476535

Aérosol

500 ml

MAINTENANCE CHAÎNE



NETTOYANT DÉGRAISSANT CHAÎNE

Le dégraissant Chaîne Engine Degreaser Spray de Putoline est spécialement élaboré pour les motos. Sa formule unique agit rapidement en éliminant les dépôts lourds d'huile et de graisse de toutes les zones contaminées (chaînes, pignons, moteurs, châssis et tous les autres composants). Il est soluble dans l'eau et ne laisse aucun résidu.

476547

Aérosol

500 ml

MAINTENANCE FILTRE À AIR



HUILE FILTRE À AIR ACTION FLUID BIODEGRADABLE

Action Fluid Bio est une huile pour filtre à air en mousse haut de gamme biodégradable. Le produit est adapté pour tous les filtres à air en mousse de haute qualité, double couche et à pores ouverts. Celle-ci peut être utilisée après le nettoyage avec Action Cleaner.

À utiliser uniquement dans un endroit bien aéré, de préférence à l'air libre, en portant des gants et des lunettes de sécurité.

480185

Aérosol

600 ml



NETTOYANT FILTRE À AIR ACTION CLEANER

Action Cleaner est recommandé par les équipes Team GP, comme meilleur produit dans le monde entier.

C'est un dégraissant soluble dans l'eau, développé spécialement pour le nettoyage de filtres à air modernes en mousse.

478979

Aérosol

600 ml



HUILE FILTRE À AIR ACTION FLUID

Action Fluid est une huile pour filtre à air en mousse haut de gamme.

Il convient d'utiliser l'huile après que le filtre à air en mousse ait été nettoyé avec Action Cleaner.

À utiliser uniquement dans un endroit bien aéré, de préférence à l'air libre, en portant des gants et des lunettes de sécurité.

479506

Bidon

1L

MAINTENANCE FILTRE À AIR



NETTOYANT FILTRE À AIR ACTION CLEANER

Action Cleaner est un nettoyant de filtre à air en mousse haut de gamme. Le dégraissant est soluble dans l'eau. Le produit garantit un nettoyage en profondeur de tous les filtres à air en mousse et il n'affecte pas la colle dans le filtre. De plus, il assure une durée de vie plus longue du moteur et du filtre.

Action Cleaner est le choix n°1 des équipes de Grand Prix du monde entier !

511109

Bidon

2L



KIT ENTRETIEN FILTRE À AIR COMPLET «ACTION KIT»

«Action Kit» contient tout ce dont vous avez besoin pour nettoyer et entretenir l'ensemble du filtre à air en mousse !

Contenu :

- Action Cleaner 4 litres
- Un seau Action Cleaner de 10 litres avec couvercle
- Grille pour le fond du seau : empêche le filtre à air d'entrer en contact avec le résidu déposé au fond du seau
- Action Fluid 1 litre
- Un seau Action Fluid de 3 litres avec couvercle
- 10 grammes de graisse céramique
- Autocollant de filtre Action
- Gants jetables



480297

CARBURATION



NETTOYANT CARBURATEUR ET INJECTION CARB CLEANER

Carb Cleaner Spray de Putoline est composé d'un amalgame complexe de solvants spécifiques. Il est préconisé pour tous les types de carburateurs.

Carb Cleaner Spray a les propriétés suivantes :

- Élimine le dépôt dans le carburateur et sur le starter, l'aiguille et les gicleurs
- Rétablit la performance du moteur en réduisant les à-coups de ralentissement et de calage du moteur
- Optimise la consommation de carburant

476544

Aérosol

500 ml



ADDITIF ESSENCE FUEL STABILIZER (ANTI OXYDANT)

Fuel Stabilizer est un produit de pointe spécialement développé pour le réservoir à carburant et tout le système d'injection. Fuel Stabilizer préserve avec efficacité et protège contre la corrosion et les dépôts causés par l'oxydation des produits comme le carburant E10 pendant des périodes comme celle du remisage d'hiver. Aide votre moteur à démarrer directement après une immobilisation prolongée. Fuel Stabilizer garde le circuit d'alimentation propre et protège les pièces internes du moteur contre la rouille. Convient pour les catalyseurs.

507826

Bidon

150 ml

CARBURATION



ADDITIF ESSENCE FUEL INJECT ET VALVE CLEANER

Fuel Inject & Valve Cleaner est un additif pour essence professionnel très efficace, servant à nettoyer tout le système d'injection. Garde propres les injecteurs, les soupapes et les chambres de combustion, ce qui conserve des performances optimales au moteur. Convient pour les catalyseurs.

507567

Bidon

150 ml



ADDITIF ESSENCE OCTANE BOOSTER (FUEL SYSTEM)

Octane Booster est un additif spécial pour essence améliorant les performances des motos de compétition. Il augmente les indices d'octane RON et MON de toutes les essences générales disponibles sur le marché (compétition et E10). Octane Booster améliore les performances du moteur et réduit le risque de dégâts au moteur à cause du cliquetis. Octane Booster place une couche protectrice sur les sièges de soupape pour allonger la durée de vie et réduire les chocs des soupapes. Convient pour les moteurs à essence 2 temps et 4 temps. Sans danger pour les catalyseurs et les moteurs modifiés.

517939

Bidon

150 ml



ADDITIF ESSENCE E10 FUEL FIGHTER

E10 Fuel Fighter est un puissant additif pour carburant. Il est spécifiquement conçu pour protéger le circuit d'alimentation contre les effets nocifs des carburants E10, qui contiennent 10 % de bioéthanol. E10 Fuel Fighter compense ces effets nocifs et évite au moteur d'être endommagé.

Le produit a les propriétés suivantes :

- Protège le circuit d'alimentation contre la corrosion
- Améliore les propriétés lubrifiantes
- Réduit les frottements internes au moteur
- Réduit la consommation de carburant
- Nettoie les injecteurs et les soupapes : il garantit une combustion optimale.

508284

Bidon

250 ml

MAINTENANCE AÉROSOL



NETTOYANT DE FREIN BRAKE CLEANER

Brake Cleaner est un nettoyant et dégraissant pour toutes les parties du freinage, comme les maîtres cylindres, les étriers et les disques. C'est un pulvérisateur puissant qui garantit le nettoyage complet des éléments.

Il ne laisse aucun résidu sur les composants nettoyés.

478978

Aérosol

500 ml

MAINTENANCE AÉROSOL

MOTEUR

CYCLE

PNEUMATIQUE

ATELIER

ACCESSOIRES

ÉLECTRICITÉ

FILTRATION

FREINAGE

TRANSMISSION



NETTOYANT SPÉCIAL COMPOSANTS ÉLECTRIQUES CONTACT CLEANER

Contact Cleaner Spray est spécialement formulé pour nettoyer et dégraisser bougies, interrupteurs et autres composants électriques. C'est un pulvérisateur puissant qui garantit le nettoyage complet des éléments difficiles d'accès ou non démontables.

Un additif spécifique empêche la corrosion des éléments.

476543

Aérosol

500 ml



NETTOYANT INTÉRIEUR CASQUE SANITIZER

Helmet Sanitizer est un nettoyant hygiénique et moussant pour casque.

Ce produit est d'une utilisation rapide et facile. Il nettoie et neutralise les odeurs désagréables dans la doublure du casque et laisse une odeur fraîche d'agrumes.

Ce nettoyant convient également pour nettoyer la coque du casque et sa visière.

Mode d'emploi :

- Tenir Helmet Sanitizer à la verticale et vaporiser sur la doublure du casque
- Essuyer avec un chiffon humide
- Laisser sécher dans un endroit chaud et bien ventilé

497361

Aérosol

500 ml



NETTOYANT INTÉRIEUR CASQUE SANITIZER

Helmet Sanitizer est un nettoyant hygiénique et moussant pour casque.

Ce produit est d'une utilisation rapide et facile. Il nettoie et neutralise les odeurs désagréables dans la doublure du casque et laisse une odeur fraîche d'agrumes.

Ce nettoyant convient également pour nettoyer la coque du casque et sa visière.

Mode d'emploi :

- Tenir Helmet Sanitizer à la verticale et vaporiser sur la doublure du casque
- Essuyer avec un chiffon humide
- Laisser sécher dans un endroit chaud et bien ventilé

506206

Aérosol

75 ml



NETTOYANT CARROSSERIE SPÉCIAL COULEUR MATT WAX

Matt Wax est une cire d'avant-garde, à base d'eau.

Sa composition unique lui permet d'être appliquée sur de la peinture mate, du métal, de l'aluminium, du titane, du carbone et du plastique.

Elle fournit une excellente protection et renforce la couleur d'origine.

492359

Aérosol

500 ml

MAINTENANCE AÉROSOL



CIRE PROTECTION METAL PROOF AND PROTECT SPÉCIAL MÉTAUX

Metal Proof & Protect est un produit de haute qualité servant à protéger contre la corrosion (pendant l'hiver), à base de cires de haute qualité et d'additifs spéciaux.

Metal Proof & Protect protège efficacement les pièces métalliques non traitées et laquées contre la corrosion provoquée entre autres par l'humidité et par l'eau salée.

Convient pour les motos de route et tout-terrain.

508285

Aérosol

500 ml



IMPERMÉABILISANT TEXTIL PROOF AND PROTECT

L'aérosol d'imprégnation Textile Proof & Protect peut être utilisé pour que des matériaux comme les textiles résistent à la saleté et à l'eau. Textile Proof & Protect est un liquide incolore transparent. Lire les instructions avant utilisation.

508286

Aérosol

500 ml



LUSTREUR SILICONE SPÉCIAL PLASTIQUES

Silicon Spray restaure les couleurs et redonne de l'éclat à une grande variété de plastiques et de surfaces peintes. Il facilite aussi les futurs nettoyages. Sa formule hydrofuge assure une protection optimale des composants électriques contre l'humidité et l'entrée d'eau.

476546

Aérosol

500 ml



LUBRIFIANT 1001 SPÉCIAL PIÈCES MÉTALLIQUES

Grâce à sa capacité de pénétration supérieure, Putoline Penetrating1001 Spray convient à de nombreuses applications. Sa composition unique permet d'utiliser cet aérosol sur les motos, scooters, vélos, jet-skis, bateaux, voitures, serrures, charnières, tondeuses à gazon et moteurs, ainsi que pour la lubrification générale à domicile. Il pénètre et lubrifie tout en chassant l'humidité, puis nettoie et protège tous les métaux.

476545

Aérosol

500 ml

NETTOYANT SPRAY



NETTOYANT COMPLET PUT OFF CONCENTRATED

Put Off Bike Cleaner est un nettoyant polyvalent ultra efficace pour les motos, les quads, les vélos, etc.

La formule concentrée, qui comprend les composants Nano Tech, fournit les propriétés suivantes :

- Garantit un nettoyage sûr et puissant
- Fournit une protection durable
- S'adapte aux surfaces délicates telles que le magnésium, les composants anodisés et l'aluminium
- Empêche l'adhérence de la saleté

486756

Spray

1L



NETTOYANT DIRT BIKE SUPER CLEANER PRO

Dirt Bike Super Cleaner Pro est un nettoyant hautement concentré, non toxique et biodégradable. Sa formule à action rapide unique élimine efficacement la boue, le sable, le goudron, la graisse et autres résidus des surfaces en plastique et métalliques.

Dirt Bike Super Cleaner Pro est recommandé pour nettoyer tous les types de moto cross et d'enduro.

Sans phosphate, il ne laisse aucune marque sur l'aluminium et n'abîme pas le caoutchouc et le plastique.

476542

Spray

1L

ANALYSES STANDARD TYPIQUES : DENSITÉ À 15°C, KG/L,020



NETTOYANT RS1 BIKE WASH PRO

RS1 Bike Wash Pro est un nettoyant biodégradable à action rapide.

Des additifs spéciaux anti-corrosifs assurent la protection de toutes les pièces métalliques. Sa formule hautement concentrée élimine efficacement la boue, le sable, le goudron, la graisse et tous autres résidus des surfaces en plastiques, métalliques, traitées ou peintes. Ce produit convient aux motos, scooters et bicyclettes.

Il n'abîme pas le caoutchouc et le plastique, tout en laissant un éclat éblouissant.

495341

Spray

1L

GRAISSE



GRAISSE RACING MULTI-USAGE HAUTES TEMPÉRATURES CERAMIC GREASE

De qualité supérieure, la graisse blanche/ambree est composée d'un complexe au lithium. Pour une excellente lubrification à faible friction, celle-ci contient un pourcentage élevé de PTFE.

494121

Tube

100 g

SPÉCIFICATIONS DU PRODUIT : N.L.G.I. KLASSE 2,5 / DIN 51825 / KP2,5N-30

ANALYSES STANDARD TYPIQUES :

DENSITÉ À 15°C, KG/L	1,000	VISCOSITÉ D'HUILE DE BASE, 40°C, MM²/S	115,00
POINT DE GOUTTE, °C	190	4-BALL WELDING LOAD, N	2550
GAMME DE TEMPÉRATURE, °C	-20/130		

GRAISSE



GRAISSE RACING MULTI-USAGE AU LITHIUM EP2

De qualité supérieure, Racing Grease est une graisse « complexe » au lithium EP2. De part sa structure particulièrement fine, elle présente une excellente stabilité qui prévient toutes séparations d'huile. Résistant à l'eau, ce produit est adapté à la compétition.

478466

Pot

600 g

SPÉCIFICATIONS DU PRODUIT : N.L.G.I. KLASSE 2 / DIN 51 502 / KP 2 N-25

ANALYSES STANDARD TYPIQUES :

DENSITÉ À 15°C, KG/L	0,950	GAMME DE TEMPÉRATURE, °C	-30/+140
PÉNÉTRABILITÉ (BARATTÉ), 0,1 MM	280	VISCOSITÉ D'HUILE DE BASE, 40°C, MM²/S	210,00
POINT DE GOUTTE, °C	>260	4-BALL WELDING LOAD, N	2800



GRAISSE BLANCHE MULTI-USAGE + PTFE WHITE ACTION GREASE

SPÉCIFICATIONS DU PRODUIT : N.L.G.I. KLASSE 2 / DIN 51 502 / KP 2 N-25

478467

Pot

600 g

ANALYSES STANDARD TYPIQUES :

DENSITÉ À 15°C, KG/L	1,000	VISCOSITÉ D'HUILE DE BASE, 40°C, MM²/S	115,00
POINT DE GOUTTE, °C	190	4-BALL WELDING LOAD, N	2550
GAMME DE TEMPÉRATURE, °C	-20/130		



GRAISSE KROON OIL SPÉCIAL ROULEMENT À BILLES

Ball Bearing Grease (La graisse pour roulement à billes) est composée d'huiles de base très raffinées, d'un savon de lithium comme épaississant et d'additifs qui lui confèrent les propriétés suivantes : Forte adhérence au métal Exceptionnel déplacement d'eau Excellente stabilité Résistance efficace à la corrosion et à l'usure Excellente pompabilité

504273

Pot

60 g

SPÉCIFICATIONS DU PRODUIT : N.L.G.I. KLASSE 2 / DIN 51 502 / KP 2 N-25

ANALYSES STANDARD TYPIQUES :

PÉNÉTRABILITÉ (BARATTÉ), 0,1 MM	280	VISCOSITÉ D'HUILE DE BASE, 40°C, MM²/S	195,00
POINT DE GOUTTE, °C	190	4-BALL WELDING LOAD, N	2600
GAMME DE TEMPÉRATURE, °C	-30/130		

SAVON ET ENTRETIEN



SAVON NETTOYANT PARFUM CITRON

- Parfum citron
- Nettoyant pour les mains particulièrement efficace
- Composés naturels non dangereux pour la peau
- Totalement soluble dans l'eau
- Ne bouche pas les canalisations

476556

Bidon

4,5 kg

SAVON ET ENTRETIEN



SAVON NETTOYANT MAIN BLANC

Hand Cleaner White est un nettoyant pour les mains, sans solvants, qui élimine les tâches tenaces présentes dans le secteur industriel, de l'automobile et de la construction.

Il contient des granulés doux pour la peau, qui retirent la saleté en douceur. Hand Cleaner White a également un effet lubrifiant qui contribue à garder votre peau douce.

Hand Cleaner White est sans danger et élimine toutes les tâches tenaces, comme l'huile, la graisse, les lubrifiants, le bitume, la rouille, le ciment, le liquide de frein, etc.

- Appliquer le nettoyant sur les mains, frotter puis rincer à l'eau
- Il est possible d'essuyer le nettoyant avec un chiffon sec
- La cartouche de 4L suffit pour 800 utilisations normales

500279

Bidon

4,5 kg



ABSORBANT HYDROCARBURE KROON OIL

Floor Grit (Granules) sont fabriqués à l'aide de matières premières fossiles spéciales (algues, coquilles etc.) La combustion de ces matières génèrent des granulés poreux présentant un grand pouvoir absorbant. Les granulés absorbent des acides, des lessives, des produits chimiques, des combustibles, des huiles, des graisses, des peintures, etc.

Application :

Floor Grit (Granules) absorbent rapidement et profondément les liquides déversés.

Le produit présente les caractéristiques suivantes :

- Absorption de matières sales et grasses
- Nettoyage et protection des sols
- Décoloration lors de l'absorption de liquides
- Granulés non volatiles
- Action anti-dérapage
- Ramassage facile
- Sans danger pour la santé et conservation illimitée

487034

Sac

20 kg



EAU DÉMINÉRALISÉE KROON OIL

Demi Water, eau déminéralisée, est totalement exempte de tous les sels minéraux, y compris le calcium et le chlore, grâce à sa formule spécifique.

L'emploi d'eau déminéralisée signifie que le détartrage appartient à une époque révolue !

Application :

Demi Water est idéal pour remplir les batteries.

508396

Bidon

1L



EAU DÉMINÉRALISÉE KROON OIL

Demi Water, eau déminéralisée, est totalement exempte de tous les sels minéraux, y compris le calcium et le chlore, grâce à sa formule spécifique.

L'emploi d'eau déminéralisée signifie que le détartrage appartient à une époque révolue !

Application :

Demi Water est idéal pour remplir les batteries.

508397

Bidon

5L

MOTUL NGEN

LES 1^{ÈRES} HUILES DURABLES HAUTE PERFORMANCE



TRAJETS QUOTIDIENS

Changement de vitesse en douceur et économie de carburant optimisée.

SPORT ET AVENTURE

Réponse précise du moteur et forte adhérence de l'embrayage.



Composées d'huiles de base régénérées haut de gamme (jusqu'à 75%)



Bidon fabriqué à partir de 50% de plastique recyclé.

MOTUL

MOTUL, HUILES DURABLES HAUTE PERFORMANCE

HUILES 2 TEMPS	408	NETTOYANT JANTES	421
HUILES 4 TEMPS	409	NETTOYANTS	422
HUILES DE BOITE / TRANSMISSION	416	NETTOYANT/PROTECTEUR	423
HUILES DE FOURCHE	417	NETTOYANT CHROME & ALUMINIUM	423
HUILES HYDRAULIQUE	418	NETTOYANTS CASQUE	424
LIQUIDES DE REFROIDISSEMENT	418	ENTRETIEN CHAINE	424
LIQUIDES DE FREIN	419	NETTOYANT/PROTECTEUR	425
HUILE/LUBRIFIANT	419	BAUME CUIR	426
ADDITIF ESSENCE	420	BOMBE ANTI-CREVAISON	426
NETTOYANT/DÉGRAISSANT	420	EFFACE RAYURE	426
NETTOYANT FILTRE A AIR	420	SAVON NETTOYANT MAIN A SEC	426
NETTOYANT FILTRE A AIR	421	HUILES MOTEUR 2 TEMPS MOTOCULTURE	427
NETTOYANT CARBURATEUR	421	HUILES MOTEUR 4 TEMPS MOTOCULTURE	427
NETTOYANT FREINS	421	HUILE CHAINE TRONÇONNEUSE	428

HUILES MOTEUR 2 TEMPS



/ 100

Toutes motos, trails, motos tout terrain, cyclomoteurs... équipés de moteurs 2 temps de faible cylindrée.

Peut être utilisé avec les systèmes de graissage séparé ou par mélange. Convient pour tous les carburants avec et sans plomb.

504575

Bidon

1L



/ 510

Lubrifiant pour moteurs 2 Temps graissage séparé ou pré-mélange Technosynthese® - Anti-fumée.

Lubrifiant Technosynthese® renforcé par une base de synthèse pour protéger contre l'usure. La base synthétique spécifique à haut pouvoir de combustion diminue les fumées et la formation de dépôts. Mélange immédiat et très stable avec le carburant. Normes : API TC - ISO -L-EGD - JASO FD - 033MOT069.

504574

Bidon

1L



526751

Bidon

4L



/ 710

Lubrifiant haute performance moteur 2 Temps graissage séparé ou pré-mélange 100% Synthétique - Ester - Anti-Fumée.

Formulé avec des bases synthétiques spécifiques à haut pouvoir de combustion qui diminuent la fumée et la formation de dépôts. Mélange immédiat et très stable avec le carburant.

Normes : API TC - ISO -L-EGD - JASO FD - 033MOT070.

504571

Bidon

1L



526750

Bidon

4L



/ EXPERT

Huile pour tous les scooters utilisés en milieu urbain. Convient pour les moteurs 2 Temps à injection directe ou à carburateur. Elle peut être utilisée dans les systèmes à graissage séparé ou en pré-mélange.

Convient pour tous les types d'Essence avec ou sans plomb et biocarburants. Compatible avec les catalyseurs.

504581

Bidon

1L

MOTEUR

CYCLE

PNEUMATIQUE

ATELIER

ACCESSOIRES

ÉLECTRICITÉ

FILTRATION

FREINAGE

TRANSMISSION

HUILES MOTEUR 2 TEMPS



/ POWER

Toutes motos, trails, motos tout terrain, cyclomoteurs... équipés de moteurs 2 temps de faible cylindrée.

Peut être utilisé avec les systèmes de graissage séparé ou par mélange. Convient pour tous les carburants avec et sans plomb.

504580

Bidon

1L

HUILES MOTEUR 4 TEMPS



/ 300V FACTORY LINE OFF ROAD 5W40

Lubrifiant motos compétition 100% synthèse. Pression d'huile constante quelque soient les conditions d'utilisations. Pour des performances moteur et embrayage optimales éviter le mélange avec d'autres huiles synthétiques ou minérales.

Intervalle de vidange : à adapter suivant utilisation.

JALOS - Fonctionnement des embrayages à bain d'huile validé sur test JASO T903.
TECHNOLOGIE ESTER Core® : MOTUL développe depuis plusieurs décennies des lubrifiants haute performances sur base ester. Ce choix d'esters associés à une sélection optimale d'autres huiles de base synthétique haute performance et couplés à un package d'additifs novateur fonctionnant en parfaite synergie forme la technologie ESTER Core®.

526737

Bidon

1L



526738

Bidon

4L



/ 300V FACTORY LINE ROAD RACING 15W50

Lubrifiant motos compétition 100% synthèse. Pression d'huile constante quelque soient les conditions d'utilisations. Pour des performances moteur et embrayage optimales éviter le mélange avec d'autres huiles synthétiques ou minérales.

Intervalle de Vidange : à adapter suivant utilisation.

JALOS - Fonctionnement des embrayages à bain d'huile validé sur test JASO T903.
TECHNOLOGIE ESTER Core® : MOTUL développe depuis plusieurs décennies des lubrifiants haute performances sur base ester. Ce choix d'esters associés à une sélection optimale d'autres huiles de base synthétique haute performance et couplés à un package d'additifs novateur fonctionnant en parfaite synergie forme la technologie ESTER Core®.

526736

Bidon

1L



526738

Bidon

4L



/ 300V FACTORY LINE OFF ROAD 15W60

Lubrifiant motos compétition 100% synthèse. Pression d'huile constante quelque soient les conditions d'utilisations. Pour des performances moteur et embrayage optimales éviter le mélange avec d'autres huiles synthétiques ou minérales.

Intervalle de vidange : à adapter suivant utilisation.

JALOS - Fonctionnement des embrayages à bain d'huile validé sur test JASO T903.
TECHNOLOGIE ESTER Core® : MOTUL développe depuis plusieurs décennies des lubrifiants haute performances sur base ester. Ce choix d'esters associés à une sélection optimale d'autres huiles de base synthétique haute performance et couplés à un package d'additifs novateur fonctionnant en parfaite synergie forme la technologie ESTER Core®.

526739

Bidon

1L



526740

Bidon

4L

HUILES MOTEUR 4 TEMPS



/ 300V2 FACTORY LINE 10W50

Lubrifiant motos compétition 100% synthèse. Pression d'huile constante quelque soient les conditions d'utilisations. Pour des performances moteur et embrayage optimales éviter le mélange avec d'autres huiles synthétiques ou minérales.

Intervalle de Vidange : à adapter suivant utilisation.

JALOS - Fonctionnement des embrayages à bain d'huile validé sur test JASO T903. TECHNOLOGIE ESTER Core® : MOTUL développe depuis plusieurs décennies des lubrifiants haute performances sur base ester. Ce choix d'esters associés à une sélection optimale d'autres huiles de base synthétique haute performance et couplés à un package d'additifs novateur fonctionnant en parfaite synergie forme la technologie ESTER Core®.

526734

Bidon

1L



526735

Bidon

4L



/ 800 FACTORY LINE OFF ROAD

Lubrifiant compétition motocross/MX, moteurs 2 Temps graissés par mélange, 100% Synthétique, Technologie ESTER Core®. Pouvoir lubrifiant extrêmement élevé pour diminuer les frottements et donc l'usure. Moteur et valves parfaitement graissés dans toutes les conditions d'utilisation. Empêche le gommage des segments et le collage des valves d'échappement. Produit coloré en rouge : permet sa détection dans l'essence. Formule améliorée : propriétés de désémulsion très renforcées, empêche le collage des boisseaux de carburateur par temps de pluie et assure une lubrification parfaite même en présence de brouillard d'eau.

Formule développée pour les Teams de Grand Prix en Moto-Cross. Utilisée avec des carburants conventionnels, sans plomb, et jusqu'à 124 d'octane. Tous Moteurs 2 Temps de compétition hautes performances graissés par mélange : Motos de cross, Enduro, Trial, Quad, Jet Ski...

504570

Bidon

1L



526741

Bidon

4L



/ 800 FACTORY LINE ROAD RACING

Motos routières, trails, motos tout terrain... équipées de moteurs 2 Temps avec boîtes de vitesses intégrées ou non, et embrayage à bain d'huile ou embrayage à sec, moteurs équipés de catalyseurs ou non.

Lubrifiant JASO MA2 pour garantir le maximum de friction entre les disques de l'embrayage à bain d'huile et assurer un parfait verrouillage de l'embrayage au démarrage, en accélération et à vitesse maximale. Améliore le passage des vitesses.

504569

Bidon

1L



/ 3000 20W50

Huile pour motos routières, trails, motos tout terrain... équipées de moteurs 4 Temps avec boîtes de vitesses intégrées ou non, embrayage à bain d'huile ou embrayage à sec et moteurs équipés de catalyseurs ou non.

Lubrifiant JASO MA2 pour garantir le maximum de friction entre les disques de l'embrayage à bain d'huile et assurer un parfait verrouillage de l'embrayage au démarrage, en accélération et à vitesse maximale. Améliore le passage des vitesses.

Autres utilisations : quads, cyclomoteurs...

504567

Bidon

1L



504568

Bidon

4L

HUILES MOTEUR 4 TEMPS



/ 5000 10W40

Lubrifiant renforcé par une base HC-TECH® pour assurer la protection du moteur et la longévité des engrenages de boîte de vitesses.

Teneur en Phosphore et Soufre optimisée (JASO MA2 < 1200 ppm) pour assurer le fonctionnement et la longévité des catalyseurs d'échappements. Lubrifiant moto 4 Temps Technologie HC-TECH®. NORMES : API SL/SJ/SH/SG - JASO MA2 - M033MOT153.

526748

Bidon

1L



526749

Bidon

4L

/ 5100

Huile pour motos routières, trails, motos tout terrain, enduro, trial... équipées de moteurs 4 temps avec boîtes de vitesses intégrées ou non et embrayage à bain d'huile ou embrayage à sec, moteurs répondant aux normes anti-pollution Euro 2 ou Euro 3, équipés de systèmes de post traitement des gaz d'échappement : catalyseurs, injection d'air à l'échappement...

Autres utilisations : motos sans pot catalytiques, scooters, quads, cyclomoteurs.

10W30



504556

Bidon

1L

504557

Bidon

4L

10W40



504558

Bidon

1L

504560

Bidon

4L

10W50



504561

Bidon

1L

504563

Bidon

4L

15W50



504564

Bidon

1L

504566

Bidon

4L

20W50



526746

Bidon

1L

526747

Bidon

4L

HUILES MOTEUR 4 TEMPS

/ 7100

Lubrifiant hautes performances, 100% synthèse, Ester pour améliorer la résistance du film d'huile à hautes températures et hauts régimes de rotation moteur.

Homologué JASO MA pour garantir un parfait verrouillage des embrayages à bain d'huile au démarrage, en accélération et à vitesse maximale. Améliore le passage de vitesses.

5W40



504544

Bidon

1L

504545

Bidon

4L

10W30



504546

Bidon

1L

504547

Bidon

4L

10W40



504548

Bidon

1L

504549

Bidon

4L

10W50



504550

Bidon

1L

504551

Bidon

4L

10W60



504552

Bidon

1L

504553

Bidon

4L

15W50



504554

Bidon

1L

504555

Bidon

4L

HUILES MOTEUR 4 TEMPS



/ EXPERT 10W40 MA

Lubrifiant Technosynthese® pour moteurs 4-Temps, spécialement étudié pour les scooters et maxi scooters.

Moteurs toutes cylindrées, avec pot catalytique ou non, avec embrayage humide. Tous scooters utilisés pour des déplacements urbains. Convient pour tous les types de carburants avec ou sans plomb et biofuels.

Lubrifiant renforcé avec une huile de base de synthèse: Procure un pouvoir lubrifiant élevé. Protège parfaitement le moteur contre l'usure et augmente sa durée de vie. JASO MA - garantit le parfait fonctionnement de l'embrayage à bain d'huile monté sur certains scooters.

504578

Bidon

1L



/ EXPERT 10W40 MB

Lubrifiant spécialement étudiée pour les scooters et maxi scooters, équipés de moteurs 4 temps, toutes cylindrées moteur, avec pot catalytique ou non, sans embrayage humide. La spécification JASO MB garantit des performances et des consommations de carburant optimales pour tous les scooters non équipés d'embrayages à bain d'huile.

Tous scooters utilisés pour des déplacements urbains ou périurbains. Convient pour tous les types d'essence avec ou sans plomb et biocarburants. Huile Moteur 4T Scooter et Maxi Scooter.

Technosynthese® JASO MB - Low Emissions.

504579

Bidon

1L



/ POWER 5W40 MA

Lubrifiant 100% Synthèse, spécialement étudié pour les scooters et maxi scooters puissants et récents. Moteurs toutes cylindrées, avec pot catalytique ou non, avec embrayage humide. Tous scooters utilisés pour des déplacements urbains ou interurbains.

Convient pour tous les types de carburants avec ou sans plomb, avec ou sans Ethanol. Diminue les frottements internes du moteur et d'améliorer le rendement mécanique. JASO MA garantit le fonctionnement de l'embrayage à bain d'huile monté sur certains scooters. Excellente résistance à haute température.

504576

Bidon

1L



/ POWER 10W30 MB

Lubrifiant 100% Synthèse, spécialement étudiée pour les scooters et maxi scooters puissants et récents, équipées de moteurs 4 temps, toutes cylindrées, avec pot catalytique ou non, sans embrayages à bain d'huile. La spécification JASO MB garantit des performances et des consommations de carburant optimales pour tous les scooters non équipés d'embrayages humides.

Tous scooters utilisés pour des déplacements urbains u périurbains. Convient pour tous les types d'essences, avec ou sans plomb et biocarburants. Huile Moteur 4T Scooter et Maxi Scooter 100% Synthèse JASO MB - Low Emissions.

504577

Bidon

1L

HUILES MOTEUR 4 TEMPS



/ NGEN 5

Lubrifiant à base synthétique de nouvelle génération pour motos à moteur 4 Temps. Lubrifiant renforcé par des Esters pour assurer des propriétés anti-usure et améliorer la protection et la durée de vie des engrenages.

Résistance améliorée du film d'huile à haute température pour une protection globale prolongée du moteur. Teneur optimisée en phosphore et en soufre pour des conditions optimales de fonctionnement du catalyseur. MOTUL NGEN 5 maintient ses performances pendant toute la durée de l'intervalle de vidange d'huile. Normes : API SM JASO MA2.

DURABILITÉ

Bidon fait à partir de 50% de plastique recyclé et recyclable

BÉNÉFICES / USP

Passage de vitesse en douceur et économie de carburant optimisée. Composée d'huiles de base régénérées haut de gamme jusqu'à 75%)

VISCOSITES

10W-30/10W-40/10W-50/15W-50

NORMES TECHNIQUES

API : SM - JASO : MA2

QUALITÉ

Mélange synthétique durable, technologie Ester

Protection élevée contre l'usure

Jusqu'à 10% de résistance en plus de l'huile

Démarrage facilité à plus de 20%

Jusqu'à 10% de + d'économie de carburant

10W30

527561

Bidon

1L



527562

Bidon

4L

10W40

527563

Bidon

1L



527564

Bidon

4L

10W50

527565

Bidon

1L



527566

Bidon

4L

15W50

527567

Bidon

1L



527568

Bidon

4L

HUILES MOTEUR 4 TEMPS



/ NGEN 7

Lubrifiant synthétique durable de nouvelle génération pour motos à moteur 4 Temps. Lubrifiant renforcé par des Esters pour assurer des propriétés anti-usure et améliorer la protection et la durée de vie des engrenages.

Résistance améliorée du film d'huile à haute température pour une protection globale prolongée du moteur. Teneur optimisée en phosphore et en soufre pour des conditions optimales de fonctionnement du catalyseur. MOTUL NGEN 7 maintient ses performances pendant toute la durée de l'intervalle de vidange d'huile. Normes : API SN JASO MA2.

DURABILITÉ

Bidon fait à partir de 50% de plastique recyclé et recyclable

BÉNÉFICES / USP

Réponse vive du moteur et forte adhérence de l'embrayage. Composée (jusqu'à 50%) d'huiles de base régénérées haut de gamme.

VISCOSITES

5W-40, 10W-40, 10W-50, 15W-50

NORMES TECHNIQUES

API : SN - JASO : MA2 supérieur à API SM)

QUALITÉ

Mélange synthétique durable, technologie Ester

Protection élevée contre l'usure

Jusqu'à 10% de résistance en plus de l'huile

Démarrage facilité à plus de 5%

Jusqu'à 10% de + d'économie de carburant

5W40



527559

Bidon

1L

527560

Bidon

4L

10W40



527553

Bidon

1L

527554

Bidon

4L

10W50



527555

Bidon

1L

527556

Bidon

4L

15W50



527557

Bidon

1L

527558

Bidon

4L

HUILES DE BOITE/TRANSMISSION



/ TRANSOIL 10W30

Lubrifiant minéral pour boîte de vitesses avec embrayage à bain d'huile. Spécialement étudié pour les boîtes avec embrayages humides utilisant une huile différente de l'huile moteur : carter de boîte de vitesses séparé du carter moteur.

Motos toutes cylindrées : Route, Trails, Cross (moteur 2T ou 4T), Enduro (moteur 2T ou 4T), Cyclomoteurs, Scooters, Quads, ATV, UTV... Convient parfaitement lorsque les constructeurs recommandent pour la transmission une huile moteur de grade SAE 10W30 ou une huile de boîte de vitesse SAE 80.

504586

Bidon

1L



/ TRANSOIL EXPERT 10W40

Lubrifiant pour Boîtes de Vitesses avec embrayages à bain d'huile. Spécialement étudié pour les boîtes avec embrayages humides utilisant une huile différente de l'huile moteur : carter de boîte de vitesses séparé du carter moteur.

Boîtes de vitesses fonctionnant en conditions sévères : racing, compétition, haute températures, fortes sollicitations... Motos toutes cylindrées : Route, Trails, Cross (moteur 2T ou 4T), Enduro (moteur 2T ou 4T), Cyclomoteurs, Scooters, Quads, ATV, UTV... Convient parfaitement lorsque les constructeurs recommandent pour la transmission une huile moteur SAE 10W40 ou une huile de boîte SAE.

504585

Bidon

1L



/ GEAR 80W90

Lubrifiant spécialement formulé pour une transmission à engrenages des scooters et cyclomoteurs. Pouvoir lubrifiant très élevé permettant de supporter les démarrages à pleine puissance et les arrêts successifs en application urbaine.

Viscosité adaptée - épaisseur du film d'huile demeure importante même lorsque le lubrifiant est porté à de très hautes températures lors d'arrêts prolongés : feux rouges, embouteillages... Excellente tenue en température pour lutter contre le manque de refroidissement de la transmission entièrement carénée. Additivation extrême-pression et anti-usure étudiée pour augmenter la durée de vie des dents d'engrenages soumises à des rotations très élevées (démultiplication courte). Pouvoir anti-corrosion, anti-oxydation et anti-mousse accru.

504587

Tube

150ML



HUILES DE FOURCHES

/ FORK OIL

Huile de fourche haute performance 100% synthétique pour tout type de fourches télescopiques inversées ou conventionnelles. Les huiles de fourches MOTUL Fork Oil Factory Line peuvent être mélangées pour obtenir l'amortissement optimum souhaité. Utiliser la quantité exacte préconisée par le constructeur.



**FACTORY LINE 2.5W
VERY LIGHT**

526742

Bidon

1L



**FACTORY LINE 2.5W
LIGHT**

526743

Bidon

1L



**FACTORY LINE 2.5W
LIGHT/MEDIUM**

526744

Bidon

1L



**FACTORY LINE 2.5W
MEDIUM**

526745

Bidon

1L

/ FORK OIL EXPERT

Fluides hydrauliques Technosynthese® spécialement formulés pour tous types de fourches télescopiques inversées ou classiques.



**5W
LIGHT**

504591

Bidon

1L



**10W
MEDIUM**

504590

Bidon

1L



**15W
MEDIUM/HEAVY**

504589

Bidon

1L



**20W
HEAVY**

504588

Bidon

1L

HUILE HYDRAULIQUE



/ HV 46

Huile de fourche haute performance 100% synthétique pour tout type de fourches télescopiques inversées ou conventiennelles.

Les huiles de fourches MOTUL Fork Oil Factory Line peuvent être mélangées pour obtenir l'amortissement optimum souhaité. Utiliser la quantité exacte préconisée par le constructeur.

527577

Bidon

1L

HUILE DE REFROIDISSEMENT



/ MOTOCOOL EXPERT (-37°C)

Motocool Expert est un liquide de refroidissement prêt à l'emploi antigel et anti-corrosion pour circuits de refroidissement de moteurs de motos.

à base de mono-éthylène glycol, Motocool Expert contient une additivation anti-corrosion de technologie hybride renforcée et adaptée aux alliages légers de moteurs de motos.

504592

Bidon

1L



HUILES DE FOURCHES



/ DOT 3 & 4 BRAKE FLUID

Fluide 100% synthétique pour tous systèmes de commande hydraulique de freins et d'embrayage répondant aux recommandations DOT 4 et DOT 3 des constructeurs.

Miscible avec les produits DOT 3, DOT 4 et DOT 5.1 NON SILICONE BASE. Point d'ébullition sec 245°C. Point d'ébullition humide 158°C.

504597

Bidon

500ML



/ DOT 4 LV BRAKE FLUID

Fluide 100% synthétique pour tous systèmes de commande hydraulique de freins et d'embrayage répondant aux recommandations DOT 4 et DOT 3 des constructeurs.

Miscible avec les produits DOT 3, DOT 4 et DOT 5.1 NON SILICONE BASE. Point d'ébullition sec 245°C. Point d'ébullition humide 158°C.

504596

Bidon

500ML



/ DOT 5.1 BRAKE FLUID

Pour tous systèmes de commande hydraulique de freins et d'embrayage répondant aux recommandations DOT 5.1, DOT 4 et DOT 3 des constructeurs. Fluidité spécialement adaptée pour les systèmes anti-blocage de freins (ABS).

504595

Bidon

500ML

HUILE/LUBRIFIANT



/ P4 E.Z LUBE

Lubrifie tous les mécanismes, leviers, câbles, axes et renvois de frein, d'embrayage, d'amortisseur, chaînes de vélo...

Protège contre la corrosion en déposant un film protecteur. Repousse l'eau et l'humidité lors des périodes prolongées d'immobilisation. Dégrippe les écrous, câbles, systèmes mécaniques oxydés...

510347

Aérosol

400ML

ADDITIF ESSENCE



/ BOOST AND CLEAN SCOOT

Additif à ajouter à l'essence. Booster d'octane pour l'essence et nettoyant circuit carburant pour moteurs 2T et 4T.

Compatible avec l'E10.

526752

Bidon

100ML

NETTOYANT/DÉGRAISSANT



/ C1 CHAIN CLEAN

MOTUL® Chain Clean nettoie parfaitement tous les types de chaînes des motos (routières et tout-terrain), des quads et des kartings.

Élimine tous les dépôts incrustés : sable, terre, huile, graisses... Sa formulation sans chlore, au pouvoir dégraissant extrême convient parfaitement aux chaînes à joints toriques O-ring, X-ring, Z-ring. Utiliser avant chaque graissage de la chaîne. 1. Vaporiser sur la chaîne et laisser sécher 5 minutes. 2. Si la chaîne est très sale, la brosser avec une brosse non abrasive. Graisser la chaîne avec MOTUL® Chain Lube Road ou Chain Paste (routières) ou Chain Lube Off Road (tout-terrain) ou Chain Lube Factory Line (compétition).

504593

Aérosol

400ML

NETTOYANT FILTRE À AIR



/ A1 AIR FILTER CLEAN

C'est un lubrifiant développé pour l'entretien des filtres à air en mousse des motos tout terrain et des quads. Renforce l'efficacité du filtre à air pour une meilleure carburation. Retient les poussières, la boue, le sable pour une plus grande longévité du moteur. Empêche l'eau de pénétrer dans le filtre. Réduction des pertes de charges à l'aspiration d'air.

Bonne résistance à l'encrassement, évite le colmatage du filtre. Séchage rapide pour éviter les coulures.

Avant chaque graissage, utiliser Air Filter Clean pour un nettoyage parfait de votre filtre à air. Vaporiser Air Filter Oil Spray

à 20 cm pour une bonne diffusion sur le filtre à air puis laisser sécher 10 minutes.

510352

Bidon

5L



/ A2 AIR FILTER OIL

C'est un lubrifiant développé pour l'entretien des filtres à air en mousse des motos tout terrain et des quads. Renforce l'efficacité du filtre à air pour une meilleure carburation. Retient les poussières, la boue, le sable pour une plus grande longévité du moteur. Empêche l'eau de pénétrer dans le filtre. Réduction des pertes de charges à l'aspiration d'air.

Bonne résistance à l'encrassement, évite le colmatage du filtre. Séchage rapide pour éviter les coulures.

Avant chaque graissage, utiliser Air Filter Clean pour un nettoyage parfait de votre filtre à air. Vaporiser Air Filter Oil Spray

à 20 cm pour une bonne diffusion sur le filtre à air puis laisser sécher 10 minutes.

510353

Aérosol

400ML

NETTOYANT FILTRE À AIR



/ A3 AIR FILTER OIL

C'est un lubrifiant développé pour l'entretien des filtres à air en mousse des motos tout terrain et des quads. Renforce l'efficacité du filtre à air pour une meilleure carburation. Retient les poussières, la boue, le sable pour une plus grande longévité du moteur. Empêche l'eau de pénétrer dans le filtre. Réduction des pertes de charges à l'aspiration d'air.

Bonne résistance à l'encrassement, évite le colmatage du filtre. Séchage rapide pour éviter les coulures.

Avant chaque graissage, utiliser Air Filter Clean pour un nettoyage parfait de votre filtre à air. Vaporiser Air Filter Oil Spray

à 20 cm pour une bonne diffusion sur le filtre à air puis laisser sécher 10 minutes.

510354

Bidon

1L

NETTOYANT CARBURATEUR



/ P1 CARBU CLEAN

Lubrifiant incolore et collant spécialement étudié pour graisser toutes les chaînes de motos routières et des kartings : standard, O-Ring, X-Ring, Z-Ring. évite les projections à grande vitesse. Très faible résistance au roulement pour plus de puissance. Augmente la durée de vie de la chaîne : réduit la friction, résiste à l'eau, au sel, et protège de la rouille. Anti-corrosion et résistance extrême pression.

Nettoyer la chaîne préalablement avec MOTUL® Chain Clean. Agiter l'aérosol et appliquer à l'intérieur de la chaîne sur toute sa longueur. Laisser sécher.

510344

Aérosol

400ML

NETTOYANT FREINS



/ P2 BRAKE CLEAN

Freins et embrayages. Résidus de plaquettes de frein, de disque d'embrayage... Toutes pièces et systèmes mécaniques. Démontage moteur, leviers, axes et renvois de frein, d'embrayage, d'amortisseur, guides et tendeurs de chaîne, traces d'huile, graisse et goudron...

MOTUL BRAKE CLEAN étant très puissant, ne pas l'utiliser sur les matières plastiques, les peintures et vernis.

510345

Aérosol

400ML

NETTOYANT JANTES



/ E3 WHEEL CLEAN

Nettoyant concentré spécialement développé pour une efficacité de nettoyage maximale sur tous types de jante (aluminium, peintes, chromées, vernies...).

Convient pour tous les types de motos.

510357

Pulvérisation

400ML

NETTOYANTS

**/ À SEC E1 WASH & WAX**

MOTUL® Wash & Wax est un nettoyant à sec pour votre moto. Grâce à sa formule exclusive Wash & Wax nettoie, protège et fait briller les carrosseries sans eau : carénages, cadres, bras oscillants.

Facile à utiliser, Wash & Wax nettoie toutes les surfaces en profondeur sans rinçage : élimine poussières et autres salissures. Dépose un film de cire protectrice pour une efficacité longue durée. Appliquer directement sur la surface à nettoyer, puis essuyer avec un chiffon doux et propre.

510355

Pulvérisation

400ML

**/ À SEC E2 WASH & WAX**

MOTUL® Wash & Wax est un nettoyant à sec pour votre moto. Grâce à sa formule exclusive Wash & Wax nettoie, protège et fait briller les carrosseries sans eau : carénages, cadres, bras oscillants.

Facile à utiliser, Wash & Wax nettoie toutes les surfaces en profondeur sans rinçage : élimine poussières et autres salissures. Dépose un film de cire protectrice pour une efficacité longue durée. Appliquer directement sur la surface à nettoyer, puis essuyer avec un chiffon doux et propre.

510356

Pulvérisation

400ML

**/ E7 INSECT REMOVER**

Élimine les traces d'insectes et les résidus organiques (fientes) des bulles, carénages, rétroviseurs, peintures, métaux et plastiques des motos.

Convient pour tous les types de motos.

510361

Pulvérisation

400ML

**/ À SEC E9 WASH & WAX SPRAY**

Wash & Wax est le nettoyage à sec de votre moto.

Grâce à sa formule exclusive Wash & Wax nettoie, protège et fait briller les pièces plastiques ou peintes sans utiliser d'eau : carénages, jantes, cadres, bras oscillants.

510363

Aérosol

400ML

NETTOYANT/PROTECTEUR



/ E5 SHINE & GO

Grâce à sa formule à base de silicone, MOTUL® Shine & Go fait briller et ravive les couleurs des surfaces plastiques des motos : carénages, peintures, garde-boues, rétroviseurs. Redonne aux couleurs l'aspect neuf. Protège les surfaces plastiques en laissant un film protecteur longue durée non collant.

Pour un résultat optimal, utiliser sur des surfaces propres, préalablement nettoyées avec MOTUL® Motowash. Pulvériser sur la surface à traiter. Laisser agir et essuyer avec un chiffon doux non pelucheux. Ne pas appliquer sur les selles de motos, les jantes ou les disques de freins. Ne pas appliquer en plein soleil.

510359

Pulvérisation

400ML



/ E10 SHINE & GO

Nettoyant à base de silicone pour faire briller toute la moto.

Carénage, plastiques, tableau de bord, garde boue, pare-chocs, peinture, vernis, éléments composite du type carbone...

Particulièrement recommandé pour obtenir l'aspect du neuf sur les couleurs qui ont tendances à ternir.

510364

Aérosol

400ML



/ E11

Spray nettoyant à sec pour les surfaces plastiques mates.

Carénage, plastiques, tableau de bord, garde boue, pare-chocs, peinture...

Redonne l'aspect mat homogène du neuf à toutes surfaces mates.

510365

Aérosol

400ML

NETTOYANT CHROME & ALUMINIUM



/ E6 CHROME & ALUMINIUM POLISH

MOTUL Chrome & aluminium Polish est une crème qui nettoie, rénove, et fait briller les parties aluminium et chromées de la moto.

Lorsque les parties chromées et en aluminium de votre moto sont ternies, MOTUL Chrome & Alu Polish leur redonne l'aspect du neuf.

Convient pour tous les types de motos.

510357

Tube

100ML

NETTOYANTS EXTÉRIEUR CASQUE



/ M1 HELMET & VISOR CLEAN

MOTUL® Helmet & Visor Clean nettoie l'extérieur du casque et la visière sans laisser de trace. Action anti-insecte. Formule neutre non agressive, non corrosive qui permet de dissoudre efficacement les salissures grasses ou sèches sans endommager la surface traitée.

Convient pour tous les casques et toutes les technologies de visières. Pulvériser sur l'extérieur du casque et la visière. Laisser agir quelques instants puis essuyer avec un chiffon doux non pelucheux.

510366

Pulvérisation

250ML

NETTOYANTS INTÉRIEUR CASQUE



/ M2 HELMET INTERIOR CLEAN

MOTUL® Helmet Interior Clean nettoie en profondeur et neutralise les mauvaises odeurs. Effet curatif, action Immédiate. Formule non irritante pour la peau, testée sous contrôle dermatologique.

510367

Pulvérisation

250ML

ENTRETIEN CHAINE



/ C2 CHAIN LUBE ROAD

Lubrifiant incolore et collant spécialement étudié pour graisser toutes les chaînes de motos routières et des kartings: standard, O-Ring, X-Ring, Z-Ring.

évite les projections à grande vitesse. Très faible résistance au roulement pour plus de puissance. Augmente la durée de vie de la chaîne : réduit la friction, résiste à l'eau, au sel, et protège de la rouille. Anti-corrosion et résistance extrême pression. Nettoyer la chaîne préalablement avec MOTUL® Chain Clean. Agiter l'aérosol et appliquer à l'intérieur de la chaîne sur toute sa longueur. Laisser sécher.

504594

Aérosol

400ML



/ C3 CHAIN LUBE OFF ROAD

Lubrifiant onctueux de couleur jaune spécialement étudié pour graisser toutes les chaînes de motos Tout-Terrain et des quads dans les conditions extrêmes d'utilisation. Convient parfaitement aux chaînes avec ou sans joint torique. Très faible résistance au roulement pour plus de puissance.

Disperse les dépôts de sable, de boue et de terre pour plus de protection. Augmente la durée de vie de la chaîne : résiste à l'eau et protège de la rouille. Protège la chaîne en conditions boueuses et humides. Non collant. Nettoyer la chaîne préalablement avec MOTUL® Chain Clean. Agiter l'aérosol et appliquer à l'intérieur de la chaîne sur toute sa longueur. Laisser sécher.

504598

Aérosol

400ML

NETTOYANT/PROTECTEUR



/ C4 CHAINE LUBE FACTORY LINE

Lubrifiant de couleur blanche spécialement développé pour graisser les chaînes de motos de compétition : Vitesse et Endurance.

Grâce à sa formulation à base d'additifs solides AW/EP, MOTUL® Chain Lube Factory Line limite la résistance au roulement et permet de gagner jusqu'à 1 cheval de puissance en plus. Anti-usure et résistance extrême pression. Compatible O-Ring, X-Ring, Z-Ring. Nettoyer la chaîne préalablement avec MOTUL® Chain Clean. Agiter l'aérosol et appliquer à l'intérieur de la chaîne sur toute sa longueur. Laisser sécher. Pour une transmission optimale, graisser la chaîne avant chaque course.

510349

Aérosol

400ML



510350

Aérosol

100ML



/ C1+C3 OFF ROAD

Kit d'entretien de chaîne OFF ROAD C1 & C3 pour tout type de chaînes de motos (routières et tout terrain) et autres véhicules (vélos, mobylettes, kartings, quads, etc...). Application : Maintenance et entretien.

Caractéristiques techniques : Ce kit d'entretien de chaîne comprend le nettoyeur de chaîne C1 CHAIN CLEAN qui élimine tous les dépôts incrustés tels que la poussière, le sable, la terre, l'huile, etc... et la graisse de chaîne C3 CHAIN LUBE ROAD particulièrement recommandée pour les motos de cross, enduro, trial, trail et quads car elle ne colle pas au sable et à la terre.



520943

Aérosol

400ML x2

+ Brosse nettoyage



/ C1+C4 ROAD

MOTUL Chain Clean nettoie parfaitement tous les types de chaînes des motos (routières et tout-terrain). élimine tous les dépôts incrustés : sable, terre, huile, graisses... Formule sans chlore, au pouvoir dégraissant extrême, convient parfaitement aux chaînes à joints toriques O-ring, X-ring, Z-ring. Lubrifiant de couleur blanche spécialement développé pour graisser les chaînes de motos de compétition: Vitesse et Endurance.

Chain Lube Factory Line limite la résistance au roulement et permet de gagner jusqu'à 1 cheval de puissance en plus. Anti-usure et résistance extrême pression. Compatible O-Ring, X-Ring, Z-Ring.

Nettoyer la chaîne préalablement avec MOTUL Chain Clean.



Pour une transmission optimale, graisser la chaîne avant chaque course. La brosse chaîne permet de garder la chaîne et le pignon propre et ainsi de prolonger leur durée de vie.

520944

Aérosol

400ML x2

+ Brosse nettoyage



/ C5 CHAIN PASTE

Lubrifiant en pâte de couleur blanche avec embout applicateur brosse spécialement étudié pour graisser toutes les chaînes de motos routières et des kartings: standard, O-Ring, X-Ring, Z-Ring. évite les projections à grande vitesse.

Très faible résistance au roulement pour plus de puissance. Augmente la durée de vie de la chaîne : réduit la friction, résiste à l'eau et au sel, protège de la rouille. Nettoyer préalablement la chaîne avec MOTUL® Chain Clean. Appliquer la pâte CHAIN PASTE et l'étaler sur toute la chaîne grâce à l'embout brosse. Pratique, peu encombrant et non inflammable, peut être stocké sans risque sous la selle de moto.

510351

Tube

150ML

BAUME CUIR



/ M3 PERFECT LEATHER

MOTUL® Perfect Leather est une crème à base de savon à l'huile d'olive, de glycérine, et d'huile de térébenthine. Nettoie, nourrit et ravive tous les types de cuirs. Peut être utilisé sur les blousons, pantalons, bottes, gants, selles en cuir, sacoches, etc...

Protège contre les agressions extérieures (frottement, décoloration), effet imperméabilisant / anti-pluie. Prolonge la durée de vie du cuir. Agiter le flacon. Appliquer la crème sur la surface à traiter à l'aide d'un chiffon propre et sec. Laisser agir quelques instants. Lustrer par mouvements circulaires. Tester préalablement sur une partie non visible.

510368

Bidon

250ML

BOMBE ANTI-CREVAISON



/ P3 TYRE REPAIR

MOTUL® Tyre Repair répare et regonfle les pneus de motos (avec ou sans chambre à air) instantanément sans démontage ni outil. Sa formule à base de latex n'altère ni la chambre à air, ni le pneu. Permet de rouler plusieurs centaines de km avant réparation définitive du pneu. Peut être utilisé sur les pneus jusqu'à 16".

L'emploi de ce produit n'est possible que si la chambre n'est pas déchirée et si le pneu n'est pas déjanté. Positionner la roue de façon que la valve soit en position 10h ou 2h d'un cadran horaire. Agiter l'aérosol. Par temps froid, le réchauffer. Fixer le raccord de l'aérosol en le vissant au filetage. Rouler immédiatement 10 à 20 km à vitesse modérée pour permettre au produit de bien se répartir. Contrôler dès que possible la pression de gonflage et la réajuster.

510346

Aérosol

300ML

EFFACE RAYURE



/ E8 SCRATCH REMOVER

Grâce à ses particules micro abrasives, Motul® Scratch Remover élimine les rayures superficielles sur toutes les surfaces peintes ou vernies : carénages de la moto, casque, etc...

Redonne l'aspect brillant aux peintures et vernis. Nettoyer préalablement la partie à traiter avec MOTUL® Moto Wash. Appliquer une noisette de crème sur un chiffon doux et étaler uniformément le produit sur toute la rayure. Laisser sécher quelques minutes puis lustrer avec le chiffon en effectuant des mouvements circulaires. Ne pas utiliser au soleil, sur des surfaces chaudes ou sur des peintures mates.

510362

Tube

100ML

SAVON NETTOYANT MAIN À SEC



/ M4 HANDS CLEAN

MOTUL® Hands Clean Nettoie les mains sans eau. Dissout les graisses, huiles, et autres salissures mécaniques tenaces. Pratique et non inflammable, peut être stocké sans risque sous la selle de la moto.

Formule non agressive testée sous contrôle dermatologique, ne dessèche pas la peau. Appliquer une noisette de crème sur les mains. Se frotter les mains; la crème se transforme alors en gomme qui absorbe les salissures mécaniques. Continuer à frotter jusqu'à ce que vos mains soient propres.

510369

Tube

100ML

HUILES MOTEUR 2 TEMPS MOTOCULTURE



/ GARDEN HI TECH

Huile spécialement formulée pour les moteurs 2 Temps des matériels de motoculture. Convient pour les carburants standards et sans plomb.

MOTUL GARDEN 2T Hi-Tech dépasse les exigences des spécifications ISO-L-EGD, JASO FD et API TC. Motoculteurs, tronçonneuses, tondeuses à gazon, débroussailleuses, motobineuses... Recommandée pour les matériels très sollicités (tronçonneuses...), à haut régimes de rotation ou travaillant en conditions intensives.

504505

Bidon

1L



/ GARDEN

Lubrifiant Technosynthese®. Pour les matériels de motoculture (tronçonneuse, tondeuse, taille-haie, débroussailleuse...).

Laisse le moteur propre sans dépôt ni résidu.

Colore le carburant en rouge pour signaler le mélange.

504515

Bidon

1L

HUILES MOTEUR 4 TEMPS MOTOCULTURE



/ 10W30

Lubrifiant pour moteurs 4 Temps de motoculture essence et diesel. Maintien du moteur en parfait état de propreté.

Propriétés détergentes et dispersantes. Le grade de viscosité SAE 10W-30 facilite les démarrages, réduit l'usure et réduit la consommation carburant. Anti-usure. Anti-oxydation.

Anti-corrosion. Anti-mousse.

NORMES API SJ/CF. Formule Technosynthese® renforcée en bases synthétiques pour une meilleure protection du moteur.

526728

Bidon

1L



504517

Bidon

600ML



/ GARDEN SAE 30

Lubrifiant pour moteurs 4 Temps de motoculture essence et diesel. Maintien du moteur en parfait état de propreté.

Protection pendant la période d'hivernage. Propriétés détergentes et dispersantes. Le grade viscosité SAE 30 permet un bon démarrage à froid, et une bonne tenue à chaud. Anti-usure. Anti-oxydation. Anti-corrosion. Anti-mousse.

NORMES API SG/CD.

526729

Bidon

1L



504519

Bidon

600ML

HUILE CHAÎNE TRONÇONNEUSE



/ TIMBER 120 GARDEN

Huile spécialement adaptée au graissage des chaînes de tronçonneuse.
Tous types de tronçonneuses à graissage manuel ou automatique.

504521

Bidon

5L



504520

Bidon

1L



/ TIMBER 150 GARDEN

Spécialement adapté au graissage des chaînes de tronçonneuse en usage professionnel.
Tous types de tronçonneuses à graissage manuel ou automatique.

Viscosité plus élevée assurant un graissage plus efficace à haute température tout en évitant les projections.

Lubrifiant à caractère filant. Très grande adhérence.

Anti-oxydation et anti-rouille. Anticorrosion et anti-usure.

526730

Bidon

20L

NETTOYANT DÉGRAISSANT



/ NETTOYANT/DEGRAISSANT SPECIALIST

500264

Aérosol

500ML



/ SUPER DEGRIPPANT SPECIALIST

500191

Aérosol

400ML



/ GRAISSE LONGUE DUREE SPECIALIST

500192

Aérosol

400ML



/ HUILE/LUBRIFIANT 3 EN 1 CHAINE ET CABLE

479727

Aérosol

120ML

CE Produit apporte une lubrification et une protection durables à la Chaîne et est compatible avec les joints toriques en O, X et Z. son exceptionnelle

Action longue durée le rend particulièrement

Adapté aux environnements secs. de plus, Il sèche rapidement et dispose d'excellentes propriétés anti-éclaboussures. une utilisation régulière aide à entretenir la performance et la durée d'utilisation de la chaîne.



/ LUBRIFIANT 3 EN 1

Ce produit à la formulation professionnelle a trois propriétés complémentaires: - Hydrofuge, il chasse l'humidité et protège de la rouille- Dégrippant, son ultra fluidité lui permet une pénétration rapide- Lubrifiant, sans encrasser

475171

Aérosol

120ML



/ HUILE/LUBRIFIANT MULTIFONCTION / JET DOUBLE POSITION

Le produit multifonction WD-40® protège le métal de la rouille et de la corrosion, s'insère dans les parties coincées, repousse l'humidité et lubrifie quasiment tout. Il élimine même la graisse, la saleté et plus encore de la plupart des surfaces.

478214

Aérosol

500ML



478214

Aérosol

200ML



482311

Aérosol

250ML



/ HUILE/LUBRIFIANT MULTIFONCTION

Le Produit Multifonction WD-40 protège le métal de la rouille et de la corrosion, s'insère dans les parties coincées, repousse l'humidité et lubrifie quasiment tout. Il élimine même la graisse, la saleté et plus encore de la plupart des surfaces. Développé pour les professionnels, ce produit multifonction a été développé pour faciliter le travail des pros, et ce en toute situation ! Son nouveau tube flexible d'une longueur de 18 cm peut être plié et maintenu dans la forme souhaitée. Ceci permet, tube relevé, d'atteindre de nombreux points difficiles d'accès qui nécessitent une application précise. Tube abaissé, le produit pourra être pulvérisé plus largement.

Avantages du produit :

- Toujours la même formule, toujours des centaines d'applications
- Repousse l'humidité pour éviter la rouille et sécher les systèmes électriques
- Pénètre pour desserrer les parties bloquées.
- Lubrifie pour que l'équipement fonctionne sans problème.
- Élimine l'huile, la saleté et la graisse.
- Protège les surfaces métallique

507490

Aérosol

600ML



529038

Aérosol

400ML



/ HUILE/LUBRIFIANT MULTIFONCTION

Le produit multifonction WD-40® protège le métal de la rouille et de la corrosion, s'insère dans les parties coincées, repousse l'humidité et lubrifie quasiment tout. Il élimine même la graisse, la saleté et plus encore de la plupart des surfaces.

475170

Aérosol

400ML



7020

Aérosol

200ML



278847

Bidon

250ML



485121

Bidon

250ML



479676

Aérosol

200ML x36



BELGOM[®]
/ ALU

Belgom Alu est un produit fantastique pour faire briller et polir l'aluminium des carters de motos, des fourreaux de fourche ou encore des jantes..., l'inox des échappements..., le cuivre et tous les alliages des voitures, motos, bateaux...

Belgom Alu contient des charges minérales finement calibrées pour un polissage doux et sans rayures. Il est également utilisé en mécanique pour polir à fond et à la main les embellages, masses d'équilibrage, conduits d'admission et d'échappement, culasses, pistons, queues de soupapes...

388540

250ML



BELGOM[®]
/ CHROMES

C'est une crème polish qui désoxyde en profondeur, fait briller et laisse une fine couche protectrice qui protège les chromes contre la corrosion tout en conservant durablement leur éclat.

Après application, une fine couche protectrice vient protéger les chromes contre la corrosion tout en conservant durablement leur éclat.

388535

250ML



BELGOM[®]
/ JANTES MOTO

Particulièrement efficace pour traiter tous les types de jantes en alu brut, anodisé, peintes ou chromées, rayonnées ou à bâtons.

Il est le produit référence des motards pour rénover et entretenir les jantes de leur véhicule.

388554

250ML



BELGOM[®]
/ RENOVATEUR CUIR

D'une consistance très légère, Belgom Rénovateur Cuir nourrit et redonne toute leur souplesse aux cuirs vieillis, craquelés ou desséchés.

Très apprécié par les selliers, Belgom Rénovateur Cuir est en particulier utilisé pour traiter les cuirs asséchés par le temps en leur procurant une véritable cure de jeunesse.

Avant l'application du traitement, il est impératif de nettoyer les cuirs avec Belgom Nettoyant Intérieur (pour ne pas décolorer le cuir), de les rincer à l'éponge humide et de bien les laisser sécher.

388527

250ML



BELGOM[®]
/ RENOVATEUR PEINTURE

Il polit et élimine l'aspect mat des carrosseries oxydées par le vieillissement et élimine les tourbillons (lavage aux rouleaux).

Pour obtenir un meilleur éclat, appliquer Belgom Lustreur Ultra Protecteur dans la foulée

477357

250ML



BELGOM[®]
/ ENTRETIEN CUIR

Garanti sans silicone, il est couramment utilisé pour l'ameublement et les vêtements.

Si vos cuirs sont très secs, traiter les préalablement avec Belgom Rénovateur Cuir en attendant plusieurs jours avant d'appliquer Belgom Entretien Cuir.

388516

250ML



BELGOM'
/ **LUSTREUR**

Pour nettoyer et faire briller toutes les peintures: métallisées, vernies ou autres.
Une brillance étincelante et durable grâce à sa formule à l'oxyde de titane, Belgom polish lustreur Ultra Protecteur donne un brillant exceptionnel à tous les types de peinture tout en les protégeant durablement contre les agressions de la pollution, les intempéries, la corrosion ou le vieillissement.

388501

250ML



VELOX

/ **LUBRIFIANT ADHERENT COURROIE TOUTES CONDITIONS**

L'adhérent courroies Velox est une solution de résine tackifiante. Il augmente l'adhérence pour une transmission de puissance plus élevée y compris pour les VAE.
Permet une réduction de l'usure des courroies et de leur vieillissement. Sa formulation convient pour tout type de courroies de vélo: crantée, plate, ronde...

521131

AEROSOL

200ML

Propriétés : Rétablit l'adhérence, Supprime les bruits, Action longue durée



/ **METAL POLISH**

Produit de nettoyage et d'entretien de renommée mondiale et récompensé internationalement.
Autosol POLISH METAL s'utilise pour toutes les surfaces métalliques.
Les impuretés et la rouille seront facilement éliminées en une seule opération.
Avec une formule équilibrée, les ingrédients fourniront également une couche protectrice sur le métal afin d'obtenir une brillance extrême.

510627

POT

750ML



510629

BOUTEILLE

250ML



/ **ALUMINIUM POLISH**

Nettoie et polit l'aluminium non traité sans laisser de rayures. Le produit est sans ammoniac.

510632

POT

750ML



/ **STAINLESS STEEL POLISH POUR APPLICATION SUR ACIER INOXYDABLE**

Spécialement formulé pour nettoyer et polir l'acier inoxydable.
Conçu pour faire briller l'acier inoxydable et polir pour obtenir une brillance extrêmement élevée.

510631

POT

750ML



/ GRAISSE KROON OIL SPECIAL ROULEMENT A BILLES

• Ball Bearing Grease (La graisse pour roulement à billes) est composée d'huiles de base très raffinées, d'un savon de lithium comme épaississant et d'additifs qui lui confèrent les propriétés suivantes :

- Forte adhérence au métal
- Exceptionnel déplacement d'eau
- Excellente stabilité
- Résistance efficace à la corrosion et à l'usure
- Excellente pompabilité

504273

Pot

60 GR



/ HUILE MOTEUR 2T CONTI CHR 2T 100% SYNTHESE

L'huile moteur CONTI CHR 2T est à faible coefficient de frottement. Elle réduit l'usure des pièces mécaniques et évite le gommage du segment et l'encrassement de la bougie. Son film haute résistance limite les risques de grippage du piston tout en assurant une parfaite étanchéité du segment. L'huile moteur CONTI CHR 2T améliore les performances du moteur, tout en réduisant l'émission de gaz polluants répondant ainsi aux normes anti-pollution. Utilisation en mélange ou en graissage séparé. Compatible avec tous les carburants avec ou sans plomb. Viscosité à 100°C cSt 8,5. Indice de viscosité -110Point éclair °C 125. Point d'écoulement °C -12. Les caractéristiques mentionnées représentent des valeurs typiques.

512215

Bidon

1L



/ GRAISSE VARIATEUR MALOSSI MRG GREASE

Graisse semi synthétique avec savon au lithium a prestations élevées. La nouvelle graisse MALOSSI 7.1 MHR GREASE est née. Conseillée pour les utilisations les plus extrêmes ou quand les températures MALOSSI 7.1 MHR GREASE est indiqué pour la lubrification de variateurs et correcteurs de couple pour scooter, qui travaillent dans de sévères conditions de charge et de température; en particulier il garanti dans l'accouplement moyeu-buselure une parfaite et continue lubrification permettant de ce fait des temps d'entretien plus espacé.

Le MALOSSI 7.1 MHR GREASE est une graisse de très haute qualité dont la formule utilise une combinaison d'huile à base minérale et synthétique dont la densité a été augmentée avec du savon de lithium complexe et un paquet balancé d'agents antioxydants, anti rouille, anti usure et E.P.

La composition chimique lui confère une propriété de résistance à l'oxydation élevée ainsi qu'à haute sollicitation thermique même en conditions d'utilisations extrêmem

491475

Tube

40GR



/ SUPER DEGRIPPANT LOCTITE LB 8018

Dégrippant et anti corrosion Conçu pour faciliter le déblocage de pièces rouillées ou non tels que vis, écrous, boulons, raccords et autres pièces filetées sur équipement industriel. Recommandé pour préparer les pièces avant lubrification et peut être utilisé comme lubrifiant et inhibiteur de corrosion léger

501942

Tube

400ML



DOPPLER

/ GRAISSE CHAÎNE DOPPLER O / X-RING

Graisse chaîne Doppler est un lubrifiant de chaîne synthétique doté d'une formule hydrofuge unique. Fillante et collante, elle pénètre profondément dans les maillons de la chaîne et y dépose une fine couche protectrice. Elle propose une protection parfaite contre la corrosion et l'usure et réduit la friction. Graisse chaîne Doppler est adaptée pour des niveaux élevés de performance sur les chaînes ouvertes, à joints toriques et en O et X des motos de route.

519525

Aerosol

400ML



DOPPLER

/ NETTOYANT / DEGRAISSANT CHAÎNE / MOTEUR DOPPLER

Ce nettoyant chaîne Doppler est facile à utiliser, il élimine rapidement saleté, crasse, poussière et huile de vos chaînes sans laisser de résidus. Il sèche en quelques minutes et aide à réduire l'usure de vos chaînes ainsi qu'à maintenir leur niveau de performance sur la durée.

519524

Aerosol

400ML



DOPPLER

/ NETTOYANT FREIN DOPPLER

Enlève les dépôts sur les garnitures, les graisses, les huiles, le liquide de freins, la saleté... Nettoie les métaux, le verre, la céramique... Évite les tourbillons de poussières de freinage nocifs pour la santé. Vaporiser sur les pièces jusqu'à ce que la saleté et la graisse disparaissent ou frotter avec un chiffon propre.

516851

Aerosol

600ML



/ GRAISSE MULTI USAGE POUR POMPE A GRAISSE

• Dégrippant et anti corrosion. Conçu pour faciliter le déblocage de pièces rouillées ou non tels que vis, écrous, boulons, raccords et autres pièces file-tées sur équipement industriel. Recommandé pour préparer les pièces avant lubrification et peut être utilisé comme lubrifiant et inhibiteur de corrosion léger

490731

Tube

400GR



/ GRAISSE MULTI USAGE POUR POMPE A GRAISSE

525329

Tube

400GR

/ POMPE À GRAISSE



490732

525328

Description	ALGI	3 EN 1
AVEC FLEXIBLE ET AGRAFE 4 MORS	490732	
MANUELLE 3 EN 1 - MARQUE 3 en 1.		525328

/ POMPE/DISTRIBUTEUR SAVON



494922



478785



492334

Désignation	Réf.
POMPE/DISTRIBUTEUR PUTOLINE POUR SAVON EN POT DE 4.5KG REF CGN 476556	494922
POMPE/DISTRIBUTEUR PUTOLINE POUR FUT 60 ET 200 L	478785
ROBINET/DISTRIBUTEUR PUTOLINE POUR FUT HUILE PLASTIQUE 20L	492334



/ BROC/DOSEUR VERSEUR POLISPORT 1L

Désignation	Référence
DOSEUR HUILE VERSEUR POLISPORT 500ML	500614
BROC/DOSEUR VERSEUR POLISPORT 1L	500615



500615



500614



/ BROC/DOSEUR GRADUE

Désignation	Référence
BROC/DOSEUR GRADUE (CAPACITE 5 LITRES)	490735





/ ENTONNOIR

Description	Réf.
ENTONNOIR ROND Ø 165 AVEC FLEXIBLE ET BOUCHON SOUPLE 40 CM	509525

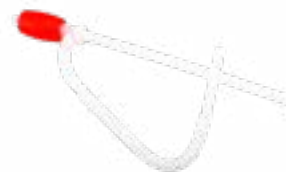

/ POMPE A VIDANGE MANUELLE

503355

Description	Réf.
POMPE A VIDANGE MANUELLE	503355



/ JERRICAN

Description	Réf.
JERRICAN HYDROCARBURES ESSENCE NORME UN (20 LITRES)	490734



/ BIDON ESSENCE 10L POLISPORT PROOCTANE AVEC BOUCHON ET MELANGEUR

Désignation	Référence
BIDON ESSENCE 10L POLISPORT PROOCTANE AVEC BOUCHON ET MELANGEUR 100ML Avec doseur d'huile gradué.indication en litre et gallon	500619



500619



/ BOUCHON DURITE

Désignation	Réf.
BOUCHON DURITE ESSENCE/HUILE/EAU DIAMETRE 3-4 MM/5-6 MM/7-8MM (X3)	512774



/ BURETTE

Description	Réf.
BURETTE HUILE 200CC SIMPLE EFFET	514328





/ BROC/DOSEUR AVEC BEC VERSEUR



Désignation	Référence
BROC/DOSEUR AVEC BEC VERSEUR 1 LITRE	503351

/ DOSEUR HUILE/RÉCUPÉRATEUR FLUIDE

Désignation	POLISPORT	POLINI	CONTI	DOPPLER
AVEC BOUCHON (125ML) - MIXER POUR PROOCTANE 10L	500618			
AVEC BOUCHON (250ML)		486950	520537	496369



500618 486950 520537 496369



/ DOSEUR HUILE GRADUE AVEC BOUCHON VERSEUR ET OBTURATEUR

Désignation	Référence
DOSEUR HUILE GRADUE AVEC BOUCHON VERSEUR ET OBTURATEUR - GRADUATION % + ML - 500ML	467537
DOSEUR HUILE MINIMAX (2 EPROUVETTES) - GRADUATION % + ML 100ML ET 500ML	462422



467537 462422



/ DOSEUR/ÉPROUVETTE

Désignation	Référence
DOSEUR/EPROUVETTE HUILE PMMA GRADUE (EPROUVETTE 250ML AVEC BOUCHON)	479181





/ ARRACHES DOUBLE FILETAGE EXTERNE DROIT



495189 508940 508941 508942

Description	Dimensions	Réf.
ADAPTABLE MBK/AM6/DERBI/RIEJU /DUCATI/BOSCH	19 x 100 & 22 x 150	508940
ADAPTABLE MBK 51 ROTOR ET VARIO/CHINOIS/GY6/139 QMB	24 x 100 & 26 x 100	495189
ADAPTABLE BOSCH/DUCATI	22 x 150 & 26 x 150	508941
ADAPTABLE BOSCH/DUCATI/MOTOPLATT	26 x 150 & 27 x 125	508942



7574 7575 449961 449962 449963 449964 508931
508932 508933 508934 508935 508936 508937 508938 508939



/ ARRACHES FILETAGE EXTERNE PAS A DROITE

Description	Dimensions	Réf.
ADAPTABLE AM6/DERBI MONTAGE DUCATI (19X100)	19 x 100	449961
ADAPTABLE PEUGEOT 103/102/101/105/104/ CYCLO	20 x 100	449962
ADAPTABLE VARIATEUR BIDALOT G2 ANCIEN MODELE	22 x 100	508932
ADAPTABLE MBK CYCLO/SCOOTER PEUGEOT/HONDA/GY6/139 QMB/CHINOIS	24 x 100	449964
ADAPTABLE KOKUSAN/MITSUB/PIAGGIO/VESPA/GILERA	26 x 100	508933
ADAPTABLE HONDA/KOKUSAN - PAS A DROITE	27 x 100	508934
ADAPTABLE PIAGGIO/GILERA/VESPA	28 x 100	508935
ADAPTABLE MVT ROTOR EXTERNE/MOTOPLAT ROTOR INTERNE PAS A DROITE	27 x 125	7575
ADAPTABLE YAMAHA CROSS 125/250	28 x 125	508936
ADAPTABLE BOSCH/DUCATI/MOTOPLAT (22X150)	28 x 125	508936
ADAPTABLE MOTOPLAT ROTOR EXTERNE A DROITE	28 x 150	508937
MOTOPLAT ROTOR INTERNE PAS A DROITE	28 x 150	508937
MOTOPLAT PAS A DROITE	30 x 150	508938
	33 x 150	508939



/ ARRACHES FILETAGE EXTERNE PAS À GAUCHE



7568

486878

Description	Dimensions	Réf.
ADAPTABLE CPI - PAS A GAUCHE	18 x 100	486878
ADAPTABLE BOOSTER/EVOLIS/SV50/SC50 - PAS A GAUCHE	27 x 100	7568



508943

508944

508945

508946

508947

508948

508949

508950

508951

508952

508953

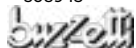

/ ARRACHES FILETAGE INTERNE

Description	Dimensions	Réf.
ADAPTABLE 125/250 KTM 2 TEMPS	26x100	508943
ADAPTABLE HONDA CROSS 125/250 2 TEMPS / SUZUKI DRZ	28x100	508944
ADAPTABLE VESPA PRIMAVERA/LX/ PIAGGIO LIBERTY 4TEMPS	30x100	508945
ADAPTABLE MAXISCOOTER 250/400/500 PIAGGIO 4TPS VOLANT DUCATI	35x100	508947
ADAPTABLE KAWASKI KX/SUZUKI RM/CRF250-450 4 TEMPS/YZ	30x125	508953
ADAPTABLE 125/150/250 HONDA 4 TEMPS	30x150	508952
ADAPTABLE MAXISCOOTER 125/150 HONDA 4 TEMPS	32x150	508946
ADAPTABLE HONDA SH300/KTM/WR/Y450F	33x150	508951
ADAPTABLE MOTEUR ROTAX 125/250/ YAMAHA ANCIEN MODELE	35x150	508948
ADAPTABLE KLX/KSF/BMW/BURGMAN/APRILIA/BOMBARDIER	38x150	508949
ADAPTABLE MAXI-SCOOTER KYMCO 300A 5004 TEMPS	39x150	508950



461573

479585

479586

496697

509023

508954

/ ARRACHES FILETAGE INTERNE

Description	Réf.
ADAPTABLE BOOSTER/NITRO CATALYSE 2004- >/MINARELLI/SUZUKI/MORINI (3 VIS)	461573
ADAPTABLE MVT/DOPPLER/MINARELLI/MORINI/APRILIA DITECH (2 VIS)	479585
ADAPTABLE MINARELLI/MORINI/SUZUKI/SOLEX - UNIVERSEL (3 VIS)	479586
ADAPTABLE MAXI-SCOOTER YAMAHA DE 125 A 400CC (6 VIS)	496697
ADAPTABLE UNIVERSEL /MOYEU EMBRAYAGE/ALTERNATEUR/ENGRENAGE (ø 96MM)	509023
ADAPTABLE MOTEUR SUZUKI (3 VIS M5)	508954



/ BLOQUE VARIATEUR

Description	SELECTION CGN MOTORISE	BUZZETTI	TUNR
ADAPT. 125/150 SYM FIDDLE/SYMPHONY/ PEUGEOT TWEET/DJANGO/CITYSTAR 4 TEMPS	501191		
ADAPT. CPI/GENERIC 6V / KYMCO/KEEWAY 50 CC 2 ET 4 TEMPS	501190		
ADAPT. CPI/KEEWAY/IE40QMB/MALAGUTTI - 150 MM	517677		
ADAPT. KYMCO 50 4 TEMPS	501107		
ADAPT. MINARELLI HORIZONTAL 2 TEMPS - 166 MM	517678		
ADAPT. MINARELLI VERTICAL - 135 MM	517679		
ADAPT. OVETTO/NEOS/NITRO/AEROX/BOOSTER X/GIGGLE 4T 50CC	501189		
ADAPT. PIAGGIO 250/300 4 TEMPS	517673		
ADAPT. PIAGGIO 400/500 - 4 TEMPS	517674		
ADAPT. SCOOTER CHINOIS/GY6	501108		
ADAPT. SUZUKI 125/150 4 TEMPS	517675		
BUZZETTI ADAPT. 50 SCOOTER PIAGGIO		209831	
BUZZETTI ADAPT. CPI/GENERIC 6V / KYMCO/ KEEWAY 50 CC 2 ET 4 TEMPS		494358	
BUZZETTI ADAPT. MINARELLI 2 TEMPS HORIZONTAL		491996	
BUZZETTI ADAPT. SYM 50CC 4 TEMPS FIDDLE/ SYMPHONY/ PEUGEOT TWEET/KISBEE		494357	
TUN'R ADAPT. 50/100 SCOOTER PEUGEOT 2TPS			482374



/ BLOQUE PISTON

Description	Réf.
M10X100 SANS EMBOUT NYLON TETE HEXAGONALE (MOT.4 TEMPS)	468226
M12X125 AVEC EMBOUT NYLON TETE HEXAGONALE POUR CLE 17MM	480772
M12X125 SANS EMBOUT NYLON TETE HEXAGONALE POUR CLE 17MM	517680
M14X125 AVEC EMBOUT NYLON	489437
M14X125 AVEC EMBOUT NYLON TETE HEXAGONALE POUR CLE 17MM	468227
M14X125 SANS EMBOUT NYLON	7582
M14X125 SANS EMBOUT NYLON TETE HEXAGONALE POUR CLE 17MM	505730





/ CLÉ À BOUGIE

Description	SELECTION CGN MOTORISE	BLACKWAY	BUZZETTI	TUNR
CLE A BOUGIE 13/19MM TOURNEVIS INTEGRE (POUR BOUGIE TYPE BM ET BPM (MOTOCULTURE))	502142			
CLE A BOUGIE 16MM ARTICULE (4 TEMPS)	517685			
CLE A BOUGIE 16MM LONGUEUR 70MM MANCHE PLIABLE (4 TEMPS)	514414			
CLE A BOUGIE 16MM/18MM LONGUEUR 110MM (4 TEMPS)	514411			
CLE A BOUGIE 16MM/18MM LONGUEUR 70MM (4 TEMPS)	514410			
CLE A BOUGIE 18MM LONGUEUR 70MM MANCHE PLIABLE (4 TEMPS)	514415			
CLE A BOUGIE 18MM/21MM LONGUEUR 110MM (2 ET 4 TEMPS)	514413			
CLE A BOUGIE 18MM/21MM LONGUEUR 70MM (2 ET 4 TEMPS)	514412			
CLE A BOUGIE 21MM A CLIQUET BLACKWAY		511990		
CLE A BOUGIE 21MM ARTICULE (2 TEMPS)	517906			
CLE A BOUGIE 21MM LONGUEUR 70MM MANCHE PLIABLE (2 TEMPS)	514416			
CLE A BOUGIE BUZZETTI 14MM/110MM (HONDA 4 TEMPS) + BLOCAGE CAOUTCHOUC			481364	
CLE A BOUGIE BUZZETTI 16MM/100MM (SPECIAL 4 TEMPS) + BLOCAGE CAOUTCHOUC			479582	
CLE A BOUGIE BUZZETTI 16MM/115MM (SPECIAL 4 TEMPS) + BLOCAGE CAOUTCHOUC			501979	
CLE A BOUGIE BUZZETTI 16MM/80MM (4 TEMPS)			479048	
CLE A BOUGIE BUZZETTI 18MM/100MM (4 TEMPS)			483864	
CLE A BOUGIE BUZZETTI 21MM ET 13MM RENFORCEE (2 TEMPS)			477259	
CLE A BOUGIE BUZZETTI 21MM/100 MM MANCHE LONG PLIABLE (2 TEMPS)			465274	
CLE A BOUGIE TUN'R 21MM TOURNEVIS INTEGRE (2 TEMPS)				7593



/ ARRACHE SILENT BLOC



Description	Réf.
ARRACHE SILENT BLOC BUZZETTI POUR DIAMETRE EXTERIEUR 30/28 MM	514561



/ RODOIR



472434



483769

Description	Nbre Pièces	Réf.
RODOIR DE CYLINDRE D32 A 89	x1	472434
PIERRE RODOIR DE CYLINDRE (X3)	x3	483769



/ ARRACHE ROULEMENT



Description	Réf.
ARRACHE ROULEMENT A INERTIE SUR BAGUE INTERIEUR BUZZETTI + ARRACHE SILENT BLOC (COFFRET)	514562



/ OUTIL NETTOYAGE GICLEURS



Description	Réf.
OUTIL NETTOYAGE GICLEURS DE 0.45 O 1.50 MM	484972



/ EXTRACTEUR A GRIFFE



Description	Réf.
(JEU DE 2) 25 A 130mm	515983



/ DEMI CARTER MOTEUR



Description	Réf.
UNIVERSEL	461576



/ OUTIL DE DEMONTAGE EXTRACTEUR / ARRACHE ROULEMENT ROULEMENT



Description	Réf.
UNIVERSEL DE 30 A 75 MM	478723



/ EXTRACTEUR/ARRACHE ROULEMENT EMBIELLAGE



Description	Réf.
	461577



484191



/ ALESOIR GICLEUR X1

Description	Réf.
COFFRET DE 21 ALESOIRS Ø 0.35 A 1.35 PAR 5/100 ^{EME}	484191
Ø 0.35	484489
Ø 0.40	484490
Ø 0.45	484491
Ø 0.50	484492
Ø 0.55	484805
Ø 0.60	484806
Ø 0.65	484807
Ø 0.70	484808
Ø 0.75	484809
Ø 0.80	484810



484489 > 484821

Description	Réf.
Ø 0.85	484811
Ø 0.90	484812
Ø 0.95	484813
Ø 1.00	484814
Ø 1.05	484815
Ø 1.10	484816
Ø 1.15	484817
Ø 1.20	484818
Ø 1.25	484819
Ø 1.30	484820
Ø 1.35	484821



/ OUTIL REGLAGE CULBUTEUR DE SOUPAPE

Description	Réf.
MOTEUR 4T - POUR ECROU 8/9/10 - JEU DE 3	481370



/ OUTIL RODAGE SOUPAPE

Description	Réf.
MOTEUR 4T - 4 VENTOUSES - RODOIR	481372



/ OUTIL COMPRISE SEGMENTS

Description	Réf.
COLLIER DE SERRAGE - PISTON D40 -> D80	484626



/ OUTIL DEMONTE SOUPAPE CULASSE 4T.

Description	Réf.
5 ADAPTATEURS	481373



501193



279297



517681



465275



481843

/ RIVE / DERIVE CHAINE

Description	SELECTION CGN MOTORISE	TUNR	BUZZETTI
DERIVE CHAINE ATELIER ARTICULE MOTO (COFFRET 415/420/428/520/525/532)	501193		
DERIVE CHAINE ATELIER TUN'R CYCLO/MOTO 420 A 530		279297	
DERIVE CHAINE MECABOITE/MOTO 420-530	517681		
DERIVE CHAINE MOTO BUZZETTI ARTICULE 415/420/428/520/525/530/532			465275
DERIVE CHAINE MOTO BUZZETTI PROFESSIONNEL (POUR CHAINES 420 428 520 525 530 532)			481843



/ POINCON DERIVE CHAÎNE



Description	Réf.
POINCON DERIVE CHAÎNE MOTO PROFESSIONNEL (POUR 481843) AVEC SUPPORT(JEU DE 3)	481366



/ OUTIL REGLAGE TENSION COURROIE



Description	Réf.
OUTIL REGLAGE TENSION COURROIE BUZZETTI ADAPT. YAMAHA 530 T-MAX	493939



/ RIVE CHAÎNE

Description	Réf.
RIVE CHAÎNE AXES CREUX MECABOITE/MOTO 520/525/530	517919



/ BROSSE NETTOYAGE CHAÎNE



Description	Réf.
415 A 630	511987



/ PRESSE RESSORT



Description	Réf.
DIAM EMBRAYAGE MAXY 125MM HAUTEUR 100MM	467825



501188



483334



481844



280794



168553



167322



168549



497081



497082



501186

/ DEMONTE EMBRAYAGE

Description	SELECTION CGN MOTORISE	BUZZETTI
DEMONTE EMBRAYAGE ADAPT. MAXI SCOOTER PIAGGIO/VESPA 125/250/300/400CC	501188	
DEMONTE EMBRAYAGE ADAPT. MAXI SCOOTER PIAGGIO/VESPA 125/250/300/400CC		481844
DEMONTE EMBRAYAGE ADAPT. SCOOTER PIAGGIO (P/ECROU 34MM)	483334	
DEMONTE EMBRAYAGE ADAPT. SCOOTER MINARELLI/PEUGEOT/KYMCO/MALAGUTI (P/ECROU 38MM)		280794
DEMONTE EMBRAYAGE ADAPT. SCOOTER MINARELLI/PEUGEOT/KYMCO/MALAGUTI (P/ECROU 39MM)		168553
DEMONTE EMBRAYAGE ADAPT. SCOOTER MINARELLI/PEUGEOT/KYMCO/MALAGUTI (P/ECROU 41MM)		167322
DEMONTE EMBRAYAGE ADAPT. SCOOTER PIAGGIO (P/ECROU 34MM)		168549
DEMONTE EMBRAYAGE UNIVERSEL A ERGOT - ENTRAXE MAX 140MM		497081
DEMONTE EMBRAYAGE UNIVERSEL A ERGOT PLAT POUR NOIX MOTO ENTRAXE MAX 125MM		497082
DEMONTE EMBRAYAGE UNIVERSEL A ERGOT - ENTRAXE MAX 140MM	501186	



/ MORDS/MORDACHE POUR ETAU



Description	Réf.
BLOCAGE FOURCHE/PISTON - MACHOIRES POUR 28 A 70 MM DE DIAMETRE	482144



/ OUTIL BLOC AXE POUR FOURCHE HYDRAULIQUE



Description	Réf.
OUTIL BLOC AXE POUR FOURCHE HYDRAULIQUE L 600 MM	458736



/ CLE A ERGOT



Description	Réf.
CLE A ERGOT/ENCOCHE POUR DEMONTAGE ECROU DIRECTION (DIAMETRE 25 A 70)	494355



/ AIMANT



Description	Réf.
AIMANT FLEXIBLE EXTRA FIN 7 MM FACOM LONGUEUR 530 MM	514359



/ AIMANT



Description	Réf.
TOURNEVIS/DOIGT MAGNETIQUE FLEXIBLE	490300



/ SERINGUE AJUSTEMENT NIVEAU HUILE



Description	Réf.
SERINGUE AJUSTEMENT NIVEAU HUILE FOURCHE	493990



/ OUTIL COMPRIME RESSORT AMORTISSEUR



Description	Réf.
	458735



/ CLE A RAYON



Description	Réf.
OUTIL CLE A RAYON MOTO 4.3MM/4.8MM/5.3MM/5.6MM/6.0MM/6.3MM	483332



/ OUTIL DE DÉMONTAGE AXE DE ROUE AVANT



Description	Réf.
AXE ROUE AVANT 12-14-17-19-22-24 MM	494345
AXE ROUE AVANT 17-19-22-24 MM	494346



/ COFFRET



Description	Réf.
COFFRET OUTILS MONTAGE JOINTS SPI FOURCHE	515125



514207



/ CLE A MOLETTE

Description	Réf.
CLE A MOLETTE 8» CHROMEÉE	514206
CLE A MOLETTE 10» CHROMEÉE	514207



514172 > 514189



/ CLÉ À PIPE DEBOUCHEE FORGÉE

Description	Réf.	Description	Réf.
6X6 PANS 7 MM	514172	6X6 PANS 16 MM	514181
6X6 PANS 8 MM	514173	6X6 PANS 17 MM	514182
6X6 PANS 9 MM	514174	6X6 PANS 18 MM	514183
6X6 PANS 10 MM	514175	6X6 PANS 19 MM	514184
6X6 PANS 11 MM	514176	6X6 PANS 20 MM	514185
6X6 PANS 12 MM	514177	6X6 PANS 21 MM	514186
6X6 PANS 13 MM	514178	6X6 PANS 22 MM	514187
6X6 PANS 14 MM	514179	6X6 PANS 23 MM	514188
6X6 PANS 15 MM	514180	6X6 PANS 24 MM	514189



514343



/ CLES

Description	Réf.
JEU DE 10 CLES MIXTES/PLATES SUR ETUI 440 DE 8 A 19MM	514343
MODULE 15 CLES MIXTES/PLATES 6 A 24	514109



514109



/ CLES

Description	Réf.
JEU DE 2 CLES CUATRO (A CLIQUET) FACOM TAILLES : 8,10,12,13 - 16,17,18,19	514342



/ CLES

Description	Réf.
JEU DE 10 CLES MIXTES A CLIQUET SURETUI DE 8 A 19MM	514344



/ CLE MIXTE

Description	Réf.
CLE MIXTE/PLATE OGV 7 MM	514153
CLE MIXTE/PLATE OGV 8 MM	514154
CLE MIXTE/PLATE OGV 9 MM	514155
CLE MIXTE/PLATE OGV 10 MM	514156
CLE MIXTE/PLATE OGV 11 MM	514157
CLE MIXTE/PLATE OGV 12 MM	514158
CLE MIXTE/PLATE OGV 13 MM	514159
CLE MIXTE/PLATE OGV 14 MM	514160
CLE MIXTE/PLATE OGV 15 MM	514161
CLE MIXTE/PLATE OGV 16 MM	514162
CLE MIXTE/PLATE OGV 17 MM	514163
CLE MIXTE/PLATE OGV 18 MM	514164
CLE MIXTE/PLATE OGV 19 MM	514165
CLE MIXTE/PLATE OGV 20 MM	514166
CLE MIXTE/PLATE OGV 21 MM	514167
CLE MIXTE/PLATE OGV 22 MM	514168
CLE MIXTE/PLATE OGV 23 MM	514169
CLE MIXTE/PLATE OGV 24 MM	514170
CLE MIXTE/PLATE OGV 32 MM	514171



/ CLE MIXTE

Description	Réf.
CLE MIXTE A CLIQUET 7 MM	514190
CLE MIXTE A CLIQUET 8 MM	514191
CLE MIXTE A CLIQUET 9 MM	514192
CLE MIXTE A CLIQUET 10 MM	514193
CLE MIXTE A CLIQUET 11 MM	514194
CLE MIXTE A CLIQUET 12 MM	514195
CLE MIXTE A CLIQUET 13 MM	514196
CLE MIXTE A CLIQUET 14 MM	514197
CLE MIXTE A CLIQUET 15 MM	514198
CLE MIXTE A CLIQUET 16 MM	514199
CLE MIXTE A CLIQUET 17 MM	514200
CLE MIXTE A CLIQUET 18 MM	514201
CLE MIXTE A CLIQUET 19 MM	514202
CLE MIXTE A CLIQUET 21 MM	514203
CLE MIXTE A CLIQUET 22 MM	514204
CLE MIXTE A CLIQUET 24 MM	514205



/ CLES



Description	Réf.
JEU DE 6 CLES HEXAGONALES A POIGNEES	514341



/ CLE HEXAGONALE



514305 > 514310

Description	Réf.
EN T 2,5 MM COULISSANTE	514305
EN T 3 MM COULISSANTE	514306
EN T 4 MM COULISSANTE	514307
EN T 5 MM COULISSANTE	514308
EN T 6 MM COULISSANTE	514309
EN T 8 MM COULISSANTE	514310



/ CLE MALE



517427

Description	Réf.
A POIGNEE EN P TORX T10	517427
A POIGNEE EN P TORX T15	517428
A POIGNEE EN P TORX T20	517429
A POIGNEE EN P TORX T25	517430
A POIGNEE EN P TORX T27	517431
A POIGNEE EN P TORX T30	517432
A POIGNEE EN P TORX T40	517433
A POIGNEE EN P TORX T45	517434
A POIGNEE EN P TORX T50	517435
A POIGNEE EN P TORX T6	517423
A POIGNEE EN P TORX T7	517424
A POIGNEE EN P TORX T8	517425
A POIGNEE EN P TORX T9	517426



/ CLE HEXAGONALE

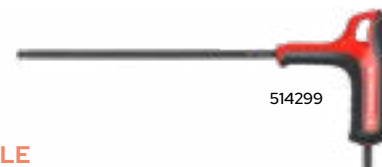

514299

Description	Réf.
A POIGNEE 4 MM EN FORME DE P	514299
A POIGNEE 5 MM EN FORME DE P	514300
A POIGNEE 6 MM EN FORME DE P	514301
A POIGNEE 7 MM EN FORME DE P	514302
A POIGNEE 8 MM EN FORME DE P	514303
A POIGNEE 10 MM EN FORME DE P	514304



/ JEU DE 6 CLES HEXAGONALES EN T



Description	Réf.
Appropriées pour les principales applications telles que la réparation de motos, l'assemblage automobile et la maintenance industrielle. Disponibles en six tailles de 2,5 mm à 8 mm. Barre transversale coulissante avec poignée en T pour une meilleure accessibilité. Broche de sécurité pour empêcher l'extraction de la barre. Extrémités en phosphate parfaitement adaptées aux vis pour une meilleure précision. Acier au chrome vanadium pour la durabilité. Finition chromée avec extrémités polies sur la tige. Jeu de 6 clés mâles en "T" : 84TCD.2,5 - 3 - 4 - 5 - 6 et 8 mm.	514340

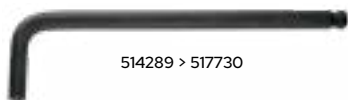

514289 > 517730

/ CLE HEXAGONALE

Description	Réf.
LONGUE 2 MM EMBOUT SPHERIQUE	514289
LONGUE 2.5 MM EMBOUT SPHERIQUE	514290
LONGUE 3 MM EMBOUT SPHERIQUE	514291
LONGUE 4 MM EMBOUT SPHERIQUE	514292
LONGUE 5 MM EMBOUT SPHERIQUE	514293
LONGUE 6 MM EMBOUT SPHERIQUE	514294
LONGUE 7 MM EMBOUT SPHERIQUE	514295
LONGUE 8 MM EMBOUT SPHERIQUE	514296
LONGUE 9 MM EMBOUT SPHERIQUE	514297
LONGUE 10 MM EMBOUT SPHERIQUE	514298
LONGUE 12 MM EMBOUT SPHERIQUE	517730



521335

514339

514338



/ CLES

Description	Réf.
JEU DE 7 CLES MALES TORX ET RESISTORX A TETE SPHERIQUE	521335
JEU DE 9 CLES HEXAGONALES EXTRA-LONGUES SUR ETUI	514339
JEU DE 9 CLES HEXAGONALES LONGUES SUR ETUI	514338



/ DOUILLE



Description	Réf.
DOUILLE CLE SERRAGE ANGULAIRE BUZZETTI CARRE 1/2"	494356



514115



514114



/ CLE DYNAMOMETRIQUE

514149

Description	Réf.
1/2" A DECLENCHEMENT 20 A 100 NM	514115
1/2" A REARMEMENT MANUELLE 40 A 200NM (CLIQUET AMOVIBLE)	514114
1/4" A DECLENCHEMENT 5 A 25NM	514149



514254



514253



514345



514234



514235



/ CLIQUET

Description	Réf.
CLIQUET 1/2" ETANCHE A MANCHE EXTENSIBLE	514254
CLIQUET 1/2" ETANCHE	514253
CLIQUET 1/4" ULTRA-COMPACT TETE FLEXIBLE 180° POUR EMBOUT 1/4"	514345
CLIQUET 1/4" A MANCHE HELICOIDAL	514234
CLIQUET 1/4" ETANCHE	514235



/ DOUILLE



Description	Réf.
OUTIL COFFRET DE DOUILLES CHROME/VANADIUM 3/8 6 PANS DE 6MM A 22 MM (24 PIECES)	480780



FACOM

/ COFFRET CLIQUET 1/2"

Description	Réf.
ETANCHE - DOUILLES 6 PANS (21 PIECES)	514352



FACOM

/ COFFRET CLIQUET 1/4"

Description	Réf.
DOUILLES - EMBOUTS 6 PANS	514350



FACOM

/ COFFRET CLIQUET 1/4"

Description	Réf.
MANCHE ROTATIF - DOUILLES - EMBOUT 6 PANS	514351



FACOM

/ COFFRET CLIQUET 1/4"

Description	Réf.
COMPACT FLEX - DOUILLES - EMBOUTS	514542



FACOM

/ COFFRET CLIQUET 1/4"

Description	Réf.
EMBOUTS (31 PIECES)	514346



FACOM

/ AUGMENTATEUR

Description	Réf.
AUGMENTATEUR 1/4" A 3/8"	514113
AUGMENTATEUR 3/8" A 1/2"	514093



FACOM

/ CARDAN UNIVERSEL

Description	Réf.
CARDAN UNIVERSEL 1/2"	514251
CARDAN UNIVERSEL 1/4"	514236



FACOM

/ DOUILLE

Description	Réf.	Description	Réf.
1/2" 6 PANS 8 MM	514255	1/2" 6 PANS 17 MM	514264
1/2" 6 PANS 9 MM	514256	1/2" 6 PANS 18 MM	514265
1/2" 6 PANS 10 MM	514257	1/2" 6 PANS 19 MM	514266
1/2" 6 PANS 11 MM	514258	1/2" 6 PANS 21 MM	514267
1/2" 6 PANS 12 MM	514259	1/2" 6 PANS 22 MM	514268
1/2" 6 PANS 13 MM	514260	1/2" 6 PANS 24 MM	514269
1/2" 6 PANS 14 MM	514261	1/2" 6 PANS 27 MM	514270
1/2" 6 PANS 15 MM	514262	1/2" 6 PANS 30 MM	514271
1/2" 6 PANS 16 MM	514263	1/2" 6 PANS 32 MM	514272

FACOM

/ DOUILLE



Description	Réf.	Description	Réf.
1/4" 6 PANS 6 MM	514239	1/4" 6 PANS 11 MM	514244
1/4" 6 PANS 7 MM	514240	1/4" 6 PANS 12 MM	514245
1/4" 6 PANS 8 MM	514241	1/4" 6 PANS 13 MM	514246
1/4" 6 PANS 9 MM	514242	1/4" 6 PANS 14 MM	514247
1/4" 6 PANS 10 MM	514243		

FACOM

/ DOUILLE



Description	Réf.
DOUILLE 1/4" POUR.EMBOUT 6,35 MM FACOM	514238

FACOM

/ DOUILLE



Description	Réf.
DOUILLE 1/4" 6 PANS 10 MM FACOM - LONGUE	515994

FACOM

/ DOUILLE



Description	Réf.
DOUILLE 3/8" PORTE EMBOUT 1/4" FACOM	514094
DOUILLE 3/8" PORTE EMBOUT 5/16" FACOM	514095

FACOM

/ DOUILLE



Description	Réf.
DOUILLE 1/2" 6 PANS 16MM POUR CLE A BOUGIE	514087
DOUILLE 1/2" 6 PANS 18MM POUR CLE A BOUGIE	514334
DOUILLE 1/2" 6 PANS 21MM POUR CLE A BOUGIE	514088

FACOM

/ JEU DE 9 DOUILLES IMPACT 1/2"



Description	Réf.
Doilles de 13/14/16/17/18/19/21/22/24 Complément indispensable à toute clé à choc 1/2". Livrée sur rack (CKS.95). Poids : 1,20 kg.	514389

FACOM

/ DOUILLE IMPACT



Description	Réf.	Description	Réf.
1/2" 6 PANS 10 MM	514368	1/2" 6 PANS 22 MM	514380
1/2" 6 PANS 11 MM	514369	1/2" 6 PANS 23 MM	514381
1/2" 6 PANS 12 MM	514370	1/2" 6 PANS 24 MM	514382
1/2" 6 PANS 13 MM	514371	1/2" 6 PANS 26 MM	514383
1/2" 6 PANS 14 MM	514372	1/2" 6 PANS 27 MM	514384
1/2" 6 PANS 15 MM	514373	1/2" 6 PANS 28 MM	514385
1/2" 6 PANS 16 MM	514374	1/2" 6 PANS 29 MM	514386
1/2" 6 PANS 17 MM	514375	1/2" 6 PANS 30 MM	514387
1/2" 6 PANS 18 MM	514376	1/2" 6 PANS 32 MM	514388
1/2" 6 PANS 19 MM	514377	3/4" 6 PANS 32MM	514111
1/2" 6 PANS 20 MM	514378	3/4" 6 PANS 36MM	514112
1/2" 6 PANS 21 MM	514379		

FACOM

/ EMBOUT PORTE DOUILLE CARRE



Description	Réf.
1/4" - 6 PANS 1/4"	514312

FACOM

/ PORTE EMBOUT COURT À JONC



Description	Réf.
1/4"	514311

FACOM

/ RALLONGE 1/2"



Description	Réf.
LONGUEUR 130 MM	514249
LONGUEUR 250 MM	514250
LONGUEUR 75 MM	514248

FACOM

/ RALLONGE 1/4"



Description	Réf.
1/4" LONGUEUR 100 MM	514233
1/4" LONGUEUR 150 MM	514232
1/4" LONGUEUR 55 MM	514237

FACOM

/ POIGNEE COULISSANTE



Description	Réf.
1/2"	514252

FACOM

/ REDUCTEUR



Description	Réf.
1/2" A 3/8"	514116
3/8" A 1/4"	514092

FACOM

/ EMBOUT



Description	Réf.
1/4" PHILLIPS PH2 LONG 50 MM	518453

FACOM

/ EMBOUTS



Description	Réf.
1/4" TORX 10 LONG 25 MM	514283
1/4" TORX 15 LONG 25 MM	514284
1/4" TORX 20 LONG 25 MM	523764
1/4" TORX 25 LONG 25 MM	514285
1/4" TORX 27 LONG 25 MM	514286
1/4" TORX 30 LONG 25 MM	514287
1/4" TORX 40 LONG 25 MM	514288

FACOM

/ EMBOUT



Description	Réf.
5/16" PHILLIPS PH2 LONG 32 MM IMPACT FACOM POUR TOURNEVIS A FRAPPER	518454

FACOM

/ EMBOUTS



Description	Réf.
1/4" 6 PANS 3,0 L 25MM	514278
1/4" 6 PANS 4,0 L 25MM	514279
1/4" 6 PANS 5,0 L 25MM	514280
1/4" 6 PANS 6,0 L 25MM	514281
1/4" 6 PANS 7,0 L 25MM	514282



514348



514349

FACOM

/ COFFRETS EMBOUTS

Description	Réf.
COFFRET DE 10 EMBOUTS TORX	514348
COFFRET DE 28 EMBOUTS (FENTE, PH, PZ, 6 PANS, TORX)	514349

TIVOLY

/ EXTRACTEUR DE GOUJON



Description	Réf.
EXTRACTEUR GOUJON CASSE ET VIS ABIMEE (COFFRET 6 PIECES)	495152
EXTRACTEUR GOUJON CASSE ET VIS ABIMEE (COFFRET 10 PCS)	524168



/ COFFRET FORETS HSS-G GOLD&BLACK

Description	Réf.
COFFRET 14 PIECES 1,15x2, 2x2, 2,5, 3x2, 3,5, 4x2, 5, 6, 8MM	520291



/ COFFRET FORETS HSS-G GOLD&BLACK

Description	Réf.
COFFRET 19 PIECES 1,15, 2x2, 2,5x2, 3x2,3,5x2, 4x2, 5x2, 5.	520292



/ COFFRET FORETS HSS-G GOLD&BLACK

Description	Réf.
COFFRET 23 PIECES 1x2, 1,5x2, 2x2, 2,5x2, 3x2, 3,5x2,4x2, 4,5	520293



/ COFFRET FORETS TOUGHCASE

Description	Réf.
COFFRET 25 PCES 3 mm à 50 mm	524622



/ FORET



Description	Réf.
FORET CONIQUE ÉTAGÉ TIVOLY GOUJURES DROITES DIA.4>20	520198



/ FORET HSS-G GOLD&BLACK



Description	Réf.	Description	Réf.
Ø13 - 101 x 151 MM	520290	Ø10 - 87 x 133 MM	520284
Ø1 - 12 x 24 MM	520264	Ø11.5 - 94 x 142 MM	520287
Ø2.5 - 30 x 57 MM	520267	Ø11 - 94 x 142 MM	520286
Ø2 - 24 x 49 MM	520266	Ø12.5 - 101 x 151 MM	520289
Ø3 - 33 x 61 MM	520268	Ø12 - 101 x 151 MM	520288
Ø4.2 - 43 x 75 MM	520272	Ø3.2 - 36 x 65 MM	520269
Ø4.5 - 47 x 80 MM	520273	Ø3.5 - 39 x 70 MM	520270
Ø4 - 43 x 75 MM	520271	Ø6.5 - 63 x 101 MM	520277
Ø5.5 - 57 x 93 MM	520275	Ø7.5 - 69 x 109 MM	520279
Ø5 - 52 x 86 MM	520274	Ø7 - 69 x 109 MM	520278
Ø6 - 57 x 93 MM	520276	Ø8.5 - 75 x 117 MM	520281
Ø1.5 - 18 x 40 MM	520265	Ø8 - 75 x 117 MM	520280
Ø10.5 - 87 x 133 MM	520285	Ø9.5 - 81 x 125 MM	520283
		Ø9 - 81 x 125 MM	520282



/ FORET ACIER RAPIDE HSS METALLAMINÉ CYLINDRIQUE COURT

Description	Réf.	Description	Réf.
Ø10	520160	Ø5,2	520172
Ø10,5	520161	Ø5,5	520173
Ø11	520162	Ø6	520174
Ø11,5	520163	Ø6,2	520175
Ø12	520164	Ø7	520176
Ø13	520165	Ø7,5	520177
Ø2	520166	Ø8	520178
Ø3	520167	Ø8,5	520179
Ø4	520168	Ø9	520180
Ø4,2	520169	Ø9,5	520181
Ø4,5	520170		
Ø5	520171		



TIVOLY

/ FORET

Description	Réf.
OUTIL COFFRET DE FORETS HSS LAMINES DIAMETRE 1 A 10 mm 1/2 mm	484216

TIVOLY

/ FRAISE



520203

Description	Réf.
FRAISE LIME CARBURE CONIQUE TRONQUÉ.Ø3	520203
FRAISE LIME CARBURE CYLINDRIQUE À RAYON Ø6	520199
FRAISE LIME CARBURE CYLINDRIQUE EN BOUT Ø6	520200
FRAISE LIME CARBURE OGIVE À RAYON Ø3	520201
FRAISE LIME CARBURES Ø3 MM (COFFRET 10 PCS)	520202



514122

520206

TIVOLY

/ TOURNE À GAUCHE

Description	FACOM	TIVOLY
TOURNE A GAUCHE A CLIQUETS / PORTE-TARAUDS DIA.M3 À M10		520206
TOURNE À GAUCHE CORPS ET MANCHE EN ACIER. N° N°2 (M4-M14)		520220
TOURNE À GAUCHE CORPS ET MANCHE EN ACIER. N° N°3 (M6-M20)		520182
TOURNE A GAUCHE TARAUDE M5 A M12	514122	

TIVOLY

/ FILIERE ACIER AU CHROME CAGE



Description	Réf.
25,4 Ø10X150	520189
25,4 Ø3X50	520190
25,4 Ø4X70	520191
25,4 Ø5X80	520192
25,4 Ø6X100	520193
25,4 Ø8X125	520194

TIVOLY

/ FILIERE



Description	Réf.
HSS E5 STEAM DIN, ENTRÉE FORME B, M.ØM12	520195
HSS E5 STEAM DIN, ENTRÉE FORME B, MF.ØM10	520196
HSS E5 STEAM DIN, ENTRÉE FORME B, MF.ØM12	520197

TIVOLY

/ TARAUD STANDARD A MAIN



Description	Réf.
HSS ØM10 (JEU DE 3 TARAUDS)	520213
HSS ØM12 x1.75 (JEU DE 3 TARAUDS)	520214
HSS ØM4 (JEU DE 3 TARAUDS)	520215
HSS ØM5 (JEU DE 3 TARAUDS)	520216
HSS ØM6 (JEU DE 3 TARAUDS)	520217
HSS ØM7 (JEU DE 3 TARAUDS)	520218
HSS ØM8 (JEU DE 3 TARAUDS)	520219

TIVOLY

/ TARAUD MACHINE



Description	Réf.
HSS CONICITÉ ARRIÈRE M10 X 1.5	520207
HSS CONICITÉ ARRIÈRE M4 X 0.7	520208
HSS CONICITÉ ARRIÈRE M5 X 0.8	520209
HSS CONICITÉ ARRIÈRE M6 X 1	520210
HSS CONICITÉ ARRIÈRE M7 X 1	520211
HSS CONICITÉ ARRIÈRE M8 X 1.25	520212



FACOM

/ PORTE FILIERE

Description	Réf.
PORTE-FILIERE Ø25,4	520205



/ HELICOIL/FILET RAPORTE REPARATION FILETAGE

Description	Réf.
M10 x 1.0	494160
M12 x 1.25	494161
M14 x 1.25	494162
M5 x 0.8	494156
M6 x 1.0	494157
M7 x 1.0	495814
M8 x 1.25	494159



TIVOLY

/ TARAUD

Description	Réf.
OUTIL COFFRET 6 TARAUDS HSS + 6 FILIÈRES HSS M 3 À M 10 + 6 FORETS HSS + ACC	520204



CGN

/ COFFRET REPARATION FILETAGE

Description	Réf.
OUTIL TARAUDAGE/FILIERE HELICOIL REPARATION FILETAGE M10X1.0 (COFFRET 15PCS)	494153
OUTIL TARAUDAGE/FILIERE HELICOIL REPARATION FILETAGE M5X0.8 (COFFRET 20PCS)	494149
OUTIL TARAUDAGE/FILIERE HELICOIL REPARATION FILETAGE M6X1.0 (COFFRET 20PCS)	494150
OUTIL TARAUDAGE/FILIERE HELICOIL REPARATION FILETAGE M7X1.0 (COFFRET 20PCS)	495813
OUTIL TARAUDAGE/FILIERE HELICOIL REPARATION FILETAGE M8X1.25 (COFFRET 20PCS)	494152
OUTIL TARAUDAGE/FILIERE REPARATION FILETAGE M12X1.25 (COFFRET 10PCS)	494154
OUTIL TARAUDAGE/FILIERE REPARATION FILETAGE M14X1.25 - BOUGIE (COFFRET 5PCS)	494155



FACOM

/ COMPOSITION 9 MODULES

Description	Réf.
- Insert inox M5, M6, M8, M10, M12. - Tarauds spéciaux pour réparer les filetages M5, M6, M8, M10, M12. - Forets spéciaux pour réparer les filetages M5, M6, M8, M10, M12. - Outils mixtes (montage des inserts et tourne à gauche) pour les inserts M5, M6, M8, M10, M12. Dimension : 330x310x40 - Poids : 1.220 kg	514148

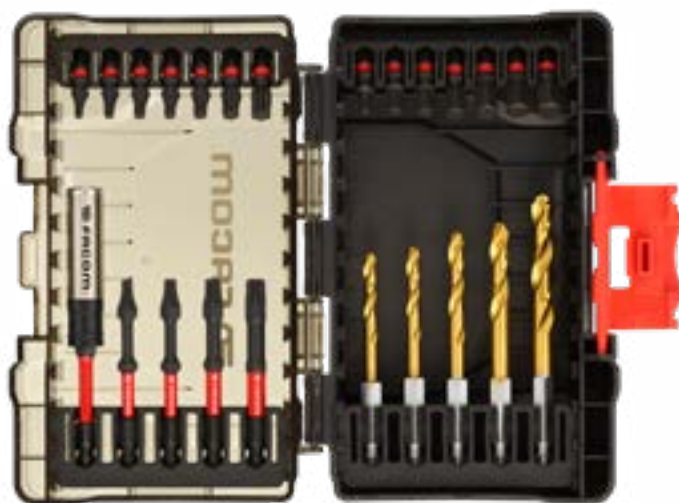

/ COFFRET EMBOUTS PERCAGES

24 PIECES

Le robuste coffret modulaire contient des accessoires conçus pour les impacts et peut être relié à des coffrets de taille petite ou moyenne.

25 mm : Hex 3, Hex 4, Hex 5, Hex 6, Hex 7 x2, Hex 8, T10, T15, T20 x2, T25, T30, T40.

63 mm : T20, T25, T30, T40.

Embouts de mèches en métal de titane (dent hexagonale) : 4 mm, 4,2 mm, 5 mm, 6 mm, 7 mm.

Porte-embouts Torsion 92 mm

514152

Description

Réf.

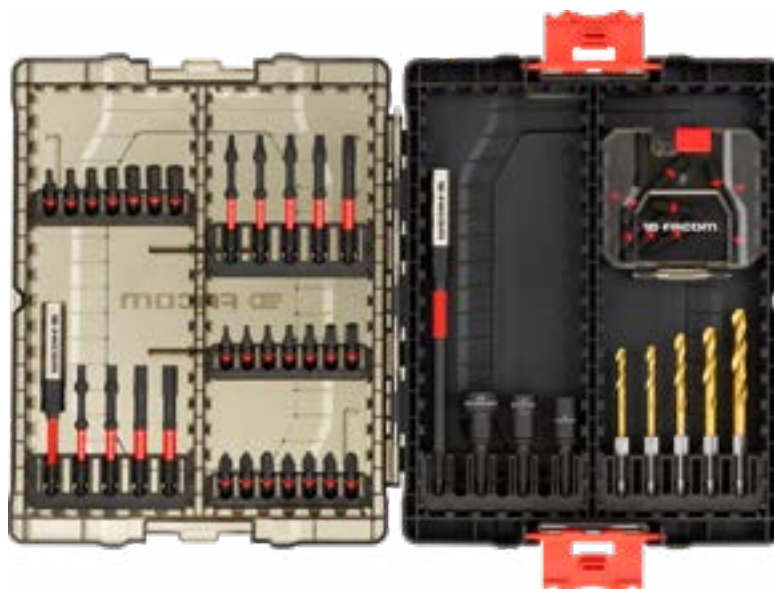

/ COFFRET EMBOUTS PERCAGES

50 PIECES

Le robuste coffret modulaire de taille moyenne contient des accessoires conçus pour les impacts, un petit compartiment de rangement en vrac et peut être relié à des coffrets de taille petite ou moyenne.

Contient : 25 mm : Hex 3, Hex 4, Hex 5, Hex 6, Hex 7 x2, Hex 8, PH1, PH2, PH3, PZ1, PZ2 x2, PZ3, T10 x2, T15, T20 x11, T25, T30, T40.

Contenant un petit coffret de rangement en vrac. 63 mm : Hex 4, Hex 5, Hex 6, Hex 7, T15, T20, T25, T30, T40.

Embouts de mèches en métal de titane (dent hexagonale) : 4 mm, 4,2 mm, 5 mm, 6 mm, 7 mm.

Tournevis pour écrous magnétique et nettoyable 8 mm, 10 mm, 13 mm.

Porte-embout Torsion 92 mm

Porte-embout Torsion 152 mm

514151

Description

Réf.



/ COMPOSITION 9 MODULES

Description	Réf.
<p>Contient 101 outils:</p> <ul style="list-style-type: none"> - Composition cliquets douilles 1/4" : Cliquet paume de main, 1 poignée coulissante, 1 poignée emmanchée, 2 rallonges, 1 cardan universel, 11 douilles : 5,5 - 6 - 7 - 8 - 9 - 10 - 11 - 12 - 13 - 14 mm, 20 embouts. - Composition cliquet douilles 1/2" : Cliquet paume de main, 1 poignée coulissante, 1 cardan universel, 2 rallonges, 18 douilles : 8 - 10 - 11 - 12 - 13 - 14 - 15 - 16 - 17 - 18 - 19 - 21 - 22 - 23 - 24 - 27 - 30 - 32 mm. - Jeu de 9 clés mâles sphériques de 1,5 à 8 mm sur étui. - 12 clés mixtes à cliquet : 8 - 9 - 10 - 11 - 12W - 13 - 14 - 15 - 16 - 17 - 18 - 19 mm. - 13 clés à pipe : 7 - 8 - 9 - 10 - 11 - 12 - 13 - 14 - 15 - 16 - 17 - 18 - 19 mm. - 9 tournevis PROTWIST plats : 2,5x75 - 3,5x75 - 4x35 - 4x100 - 4x300 - 5,5x35 - 5,5x100 - 6,5x150 avec écrou, 8x175 avec écrou. - 3 tournevis PROTWIST Pozidriv® : PZ 1x100 - 2x35 - 2x125 mm. - 7 tournevis PROTWIST Phillips® : 0x75 - 1x25 - 1x100 - 2x35 - 2x125 - 2x250 - 3x150 mm. - 3 tournevis Torx® : 6x35 - 7x35 - 8x75 mm. - 7 tournevis Resistorx® : TT 10 - 15 - 20 - 25 - 27 - 30 - 40. - 4 pinces : multiprise, pince-étau, becs 1/2 ronds, pince coupante. - 1 marteau rivoir, 1 	514363



/ COMPOSITION 9 MODULES

Description	Réf.
<p>Contient :</p> <ul style="list-style-type: none"> - Composition cliquet - Douilles 1/2" avec douilles de 10 à 32 mm, rallonge et cardan - 16 clés mixtes : 6 - 7 - 8-9-10-11-12-13-14-15-16-17-18-19-22-24 mm - 6 tournevis plats : 3,5x75 - 3,5x100 - 4x100 - 5,5x100 - 6,5x150 - 8x175 avec écrou - 2 tournevis Phillips PH1 - PH2 - 1 marteau rivoir, 1 maillet à embouts interchangeable, 3 chasse-goupilles 4 - 5 - 6 mm, 1 burin, 1 pointeau - Composition cliquet douilles 1/4» avec douilles de 5,5 à 14 mm, rallonges, cardan, poignée, tournevis, jeu de 9 clés 6 pans de 1,5 à 8 mm, jeu de 8 clés torx de 10 à 45, jeu d'embouts plats, Phillips Pozidriv Résistorx - 5 pinces: Coupante, demi-ronde becs droits, demi-ronde becs coudés, multiprise, pince étai 	514364



/ EMBOUTS

Description	Réf.
MODULE 20 EMBOUTS DE VISSAGE	514102



/ CLES

Description	Réf.
MODULE 7 CLES MALES EN T 6 PANS TETE SPHERIQUE	514107



/ CLES

Description	Réf.
MODULE 7 CLES MALES EN T TORX TETE SPHERIQUE	514108



/ CLE A BOUGIE

Description	Réf.
MODULE CLE A BOUGIE (9 PIECES)	514100



/ MODULE 8 TOURNEVIS PROTWIST

Description	Réf.
6 CRUCIFORMES - 2 PLAT DONT 4 BOULES Contient : - AN 4X25 - 5,5X35 - ANP 0X75 - 1X25 - AND 0X75 - 1X100 - 2X35 - 2X125. - Plateau thermoformé PL.326 - Poids : 785 g - Dimension plateau ; 418X175X40	514097



/ MODULE 8 TOURNEVIS PROTWIST

Description	Réf.
6 PLATS - 2 CRUCIFORMES Contient : - AN 3X75 - 3,5X100 - 5,5X125 - 4X100 - AWH 6,5X150 - 8X175 - ANP 1X100 - 2X125. - Plateau thermoformé PL.325 - Poids : 985 g - Dimension plateau ; 418X175X40	514096



/ MODULE 10 TOURNEVIS PROTWIST

Description	Réf.
CRUCIFORME DONT 2 BOULES Contient : - AND 1X100 - 2X125 - 2X35 - ANP 0X75 - 1X25 - 1X100 - 2X35 - 2X125 - 2X250 - 3X150 - Plateau thermoformé : PL.677 - Poids 900 g, Dimension plateau ; 418X188X40	514098



/ MODULE 10 TOURNEVIS PROTWIST RESISTORX

Description	Réf.
Contient : - AEX 6X35 - 7X35 - 8X75 - ANXR 10X75 - 15X75 - 30X125 - 40X150 - 20X100 - 25X100 - 27X100 - Plateau thermoformé : PL.678 - Poids : 900 g, Dimension plateau ; 418X175X40	514099



/ MODULE 4 PINCES A CIRCLIPS

Description	Réf.
OUVRANTE ET FERMANTE/DROITES ET 90° Contient : 177A.13 (10 - 25), 177A.18 (18 - 60), 179A.13 (12 - 25), 179A.18 (18 - 60) Plateau thermoformé : PL.332A - Poids : 0.842 g - Dimension plateau : 418X175X40 <i>Compatible avec le système de rangement modulaire FACOM : Adapté aux servantes CHRONO, JET, CHRONO XL, CHRONO+, JET XL et JET+.</i>	514105



/ MODULE 5 PINCES

Description	Réf.
Contient : - 1 Pince multiprise - 1 Pince étou - 1 Pince becs 1/2 ronds - 1 Pince becs 1/2 ronds coudés - 1 Pince coupante - Plateau thermoformé : PL.657	514101

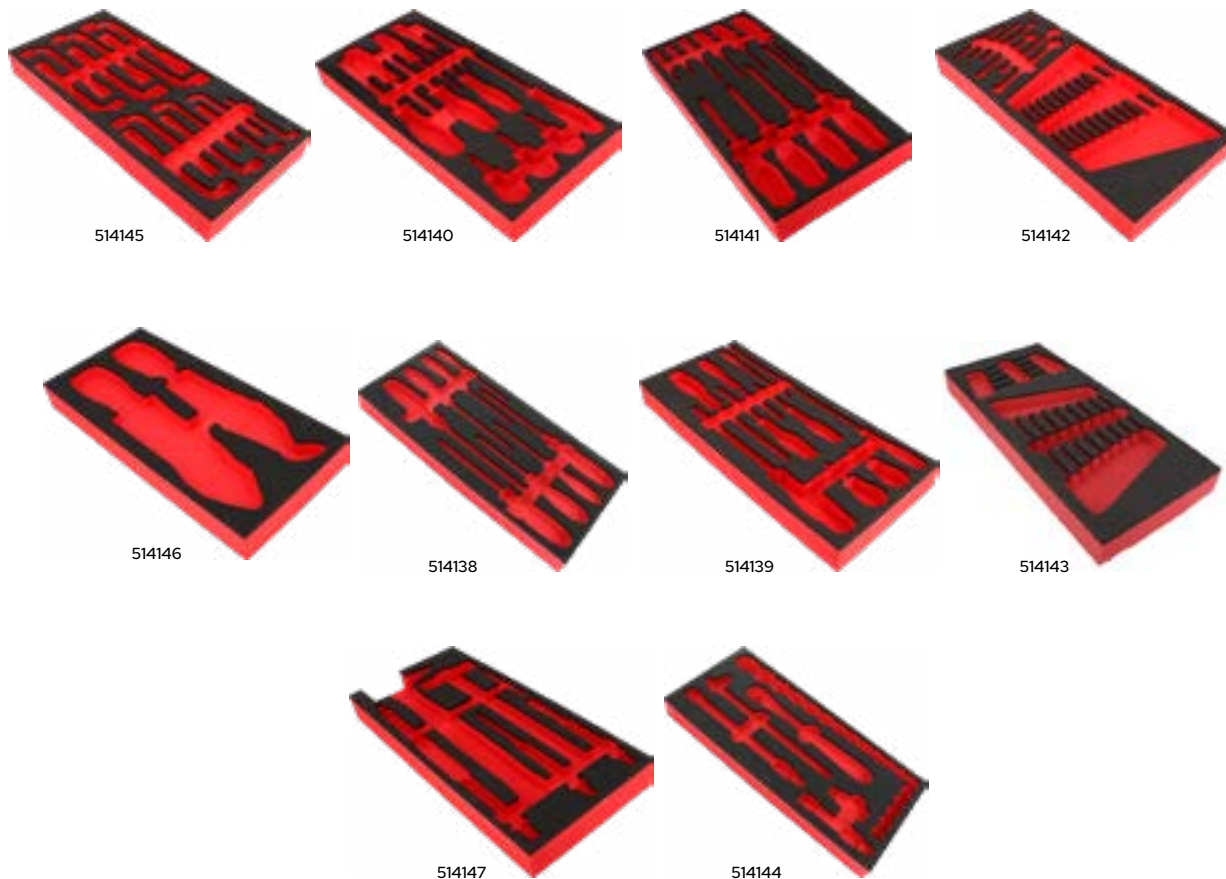

/ PLATEAU MOUSSE

Description	Réf.
POUR 13 CLES A PIPES 6 PANS Plateau vide pour module de 13 clés à pipes 6 pans. Compatible avec le module : MODM.75.	514145
POUR MODULE 10 TOURNEVIS PROTWIST (CRUCIFORME DONT 2 BOULES) Plateau vide pour module mousse 10 tournevis Protwist. Compatible avec le module : 514098	514140
POUR MODULE 10 TOURNEVIS RESISTORX (TORX) Plateau vide pour module mousse 10 tournevis Resistorx. Compatible avec le module : 514099	514141
POUR MODULE 17 CLES MIXTES/PLATES Plateau vide pour module de 17 clés mixtes de 6 à 24 mm. Compatible avec le module : MOD.440-1.	514142
POUR MODULE 4 PINCES (3 CPE ET 1 ETAU) Plateau vide pour module de 3 pinces CPE et 1 pince étau. Compatible avec le module : MODM.CPEA1.	514146
POUR MODULE 8 TOURNEVIS PROTWIST (6 PLATS - 2 CRUCIFORMES) Plateau vide pour module mousse 8 tournevis Protwist. Compatible avec le module : 514096	514138
POUR MODULE 9 TOURNEVIS PROTWIST Plateau mousse vide pour module mousse de 9 tournevis Protwist. Compatible avec le module : MOD.AT4	514139
POUR MODULE MODM.467J12 Compatible avec le module : MODM.467J12	514143
POUR MODULE MODM.MI6 Compatible avec le module : MODM.MI6	514147
POUR MODULE MODM.SIA Compatible avec le module : MODM.SIA.	514144



/ COFFRET TOURNEVIS

Description	Réf.
5 TOURNEVIS DE PRECISION MICROTECH Comprenant : - 4 tournevis fente : AEF.1,5x35 - AEF.1,8x35 - AEF.2x35 - AEF.2,5x35. - 1 tournevis Phillips® : AEFP.00x35. Dimensions du coffret : L.178 x L.91 x H.25.	514329



/ JEU DE 6 TOURNEVIS

Description	Réf.
PROTWIST (4 PLATS ET 2 CRUCIFORMES) Contient : - AN3,5X75- AN4X100- AN5,5X150- AN6,5X150- ANPIX100- ANP2X125 Poids : 590 g	514543



/ JEU DE 6 TOURNEVIS

Description	Réf.
RESISTORX FACOM (TORX) Contient : - ANX10X75- ANX15X75- ANX20X100- ANX25X100- ANX30X125- ANX40X150	514336



/ TOURNEVIS TORX

Description	Réf.	Description	Réf.
PROTWIST 10X75	514218	PROTWIST 25X100	514221
PROTWIST 15X75	514219	PROTWIST 30X125	514222
PROTWIST 20X100	514220		



/ TOURNEVIS PLAT

Description	Réf.
PROTWIST 2.5X75	521215
PROTWIST 3X75	514208
PROTWIST 4X100	514209
PROTWIST 5.5X125	514211
PROTWIST FORGE 6.5X150	514212
PROTWIST FORGE 8X150	514213



/ TOURNEVIS CRUCIFORME

Description	Réf.
PROTWIST PH 0X75	514210
PROTWIST PH 1X100	514216
PROTWIST PH 2X125	514217
PROTWIST PZ 1X100	514214
PROTWIST PZ 2X125	514215



/ TOURNEVIS A CLIQUET

Description	Réf.
TOURNEVIS A CLIQUET PROTWIST + 15 EMBOUTS DE VISSAGE	519543



/ TOURNEVIS



Description	Réf.
REGLAGE CARBU GURTNER CARBU PEUGEOT ACCES DIFFICILE (L18CM)	481666
EXTRA LONG TETE PLATE SPECIAL CARBU ACCES DIFFICILE (L30CM)	481665



/ TOURNEVIS TORX



Description	Réf.
PLAT RENVOI D'ANGLE REGLAGE CARBURATEUR (LONG.430MM/ANGLE 110°)	484627



/ TOURNEVIS ASSISTE ELECTRIQUE



Description	Réf.
TOURNEVIS ASSISTE ELECTRIQUE 4V AVEC 10 EMBOUTS PH/PZ/6 PANS	517735



/ COFFRET TOURNEVIS



Description	Réf.
EMBOUT PROTWISTFACOM 3 EN 1 Comprenant : ACL.2A : Poignée porte-lames réversibles. E.120 : Jeu mixte de 28 embouts 1/4". AMZ.E : Lame porte-embouts 6 pans 1/4". Poids : 420 g	514337



/ JEU DE 3 PINCES

Description	Réf.
MULTIPRISE/COUPANTE/A BECS	514353



/ PINCE MULTIPRISE



Description	Réf.
A VERROUILLAGE 250MM GAINAGE CPE	514117



514223



514224



/ PINCE À BEC

Description	Réf.
1/2 RONDE DROITE 200MM	514223
1/2 RONDE COUDE 200MM	514224



/ PINCE À BEC LONG



Description	Réf.
1/2 RONDE COUDE 200MM	514225



/ PINCE

Description	Réf.
PINCE A DENDUER	514227



/ PINCE

Description	Réf.
PINCE COUPANTE DIAGONALE 160MM	514226



/ PINCE

Description	Réf.
PINCE A CIRCLIPS EXTERIEUR 10-25 BEC 90°	514276
PINCE A CIRCLIPS EXTERIEUR 10-25 BEC DROIT	514273



/ PINCE

Description	Réf.
PINCE A CIRCLIPS INTERIEUR 12-25 BEC 90°	514277
PINCE A CIRCLIPS INTERIEUR 12-25 BEC DROIT	514274
PINCE A CIRCLIPS INTERIEUR 18-60 BEC DROIT	514275



/ PINCE

Description	Réf.
PINCE A RIVETER	514150



/ PINCE

Description	Réf.
PINCE ETAUX A BECS LONGS	514354

/ PINCE



Description	Réf.
PINCE POUR COLLIERS PM	514366



/ PINCE

Description	Réf.
PINCE POUR COLLIERS CLIC	514367



/ PINCE

Description	Réf.
PINCE A CLIPS 4 EN 1 (P/CIRCLIPS INTERIEURS ET EXTERIEURS)	461572



/ PINCE



Description	Réf.
PINCE A CLIPS AVEC BECS A 90° (P/CIRCLIPS INTERIEURS PROFONDS)	484625



/ TIRE RESSORT



Description	Réf.
TIRE RESSORT UNIVERSEL (EN T A CROCHET)	449901



/ PINCE



Description	Réf.
PINCE A CLIPS 3 EN 1	452089



/ OUTIL CHASSE JOINT



Description	Réf.
OUTIL CHASSE JOINT TORIQUE	472442



/ PINCE



Description	Réf.
PINCE A FREINER/TORSADER FIL SECURITE COMPETITION MOTO	503963



/ FIL A FREINER



Description	Réf.
FIL A FREINER / TORSADER SECURITE COMPETITION MOTO 0.7MM - LONGUEUR 8 M.	503964



/ LIMES

Description	Réf.
JEU 5 LIMES DEMI-DOUCE EMMANCHEE 200MM	514125
LIME DEMI-RONDE DEMI-DOUCE EMMANCHEE 200MM	514124
LIME RONDE DEMI-DOUCE EMMANCHEE 200MM	514126

MOTEUR

CYCLE

PNEUMATIQUE

ATELIER

ACCESSOIRES

ÉLECTRICITÉ

FILTRATION

FREINAGE

TRANSMISSION



/ POINTE A TRACER

Description	Réf.
POINTE A TRACER ACIER 190 MM	514118



/ POINTEAU DE PRECISION

Description	Réf.
POINTEAU DE PRECISION DIAM.6MM	514326



/ CUTTER

Description	Réf.
CUTTER LAME SECABLE 9 MM FACOM	514355



/ CUTTER

Description	Réf.
CUTTER LAME SECABLE 18 MM FACOM	514356



/ LAMES CUTTER

Description	Réf.
ETUI 10 LAMES SECABLES 18 MM	514358
ETUI 10 LAMES SECABLES 9 MM	514357



/ SCIE A METAUX

Description	Réf.
SCIE A METAUX	514230



/ LAME DE SCIE

Description	Réf.
LAME DE SCIE A METAUX 10 DENTS/CM	514121



/ EMPORTE PIÈCES

Description	Réf.
EMPORTE PIÈCES (Ø2-3-4-5)	520187
EMPORTE PIÈCES (Ø6-8-10)	520188



/ MARTEAU

Description	Réf.
MARTEAU RIVOIR 32 MM	514228



/ MASSETTE

Description	Réf.
MASSETTE CORPS ACIER EMBOUT INTERCHANGEABLE 32 MM	514323
MASSETTE SANS REBOND EMBOUT INTERCHANGEABLE 40MM	514229



/ EMBOUTS

Description	Réf.
EMBOUT NYLON POUR MASSETTE 32MM	514325
EMBOUT POLYURETHANNE POUR MASSETTE 32MM	514324



514313



514314



514315



/ BURIN

Description	Réf.
BURIN EXTRA-PLAT LARGEUR 26MM- LONGUEUR 235MM	514313
BURIN LARGEUR 24MM - LONGUEUR 200MM	514314
BURIN GAINÉ LARGEUR 20MM - LONGUEUR 200MM	514315



/ TOURNEVIS A PERCUSSION

Description	Réf.
TOURNEVIS A PERCUSSION/FRAPPER (+ 6 EMBOUTS DIFFERENTS)	480234

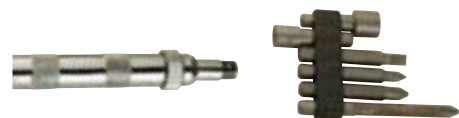

514360



/ CHASSE-GOUPILLES

514319 > 514322 514316 > 514318



Description	Réf.
CHASSE-GOUPILLES GAINÉ 2 MM	514316
CHASSE-GOUPILLES GAINÉ 3 MM	514317
CHASSE-GOUPILLES GAINÉ 4 MM	514318
CHASSE-GOUPILLES GAINÉ 5 MM	514319
CHASSE-GOUPILLES GAINÉ 6 MM	514320
CHASSE-GOUPILLES GAINÉ 8 MM	514321
CHASSE-GOUPILLES GAINÉ 10 MM	514322
JEU DE 7 CHASSE-GOUPILLES EN TROUSSE (2 A 10 MM)	514360



/ MODULE TOURNEVIS

Description	Réf.
A FRAPPER FACOM (17 PIECES) Contient : - NS.260A - NS.236A - ENH. 5 - 6 - 8 - 10 - END.2 n°2 - 3 - ENP.2 n°2 - 3 - 4 - ENX.2 20 - 25 - 30 - 40 - 45 - 55 - Plateau thermoformé : PL.380 - Poids : 648 g, Dimension plateau : 418X175X40 Compatible avec le système de rangement modulaire FACOM : Adapté aux servantes CHRONO, JET, CHRONO XL, CHRONO+, JET XL et JET+.	514104



/ JEU DE CALES

Description	SELECTION CGN MOTORISE	FACOM
JEU DE 13 CALES EPAISSEUR (0.05->1.00MM) REGLAGE CULBUTEUR SOUPAPES/ALLUMAGE RUPTEUR	511509	
JEU DE 17 CALES EPAISSEUR (0.02->1.00MM) REGLAGE CULBUTEUR SOUPAPES/ALLUMAGE RUPTEUR	501195	
JEU DE 19 CALES FACOM		514333



514089

/ REGLET

Description	Réf.
INOX FLEXIBLE 150 MM 2 FACES	514089
INOX FLEXIBLE 300 MM 2 FACES	514090

MOTEUR

CYCLE

PNEUMATIQUE

ATELIER

ACCESSOIRES

ÉLECTRICITÉ

FILTRATION

FREINAGE

TRANSMISSION



/ METRE A RUBAN

Description	Réf.
METRE A RUBAN 3M x 19 MM DOUBLE FACES AVEC BLOCAGE	514231



/ MICROMETRE

Description	Réf.
ANALOGIQUE/PALMER MECANIQUE 25-50MM (LECTURE 1/100)	512619
MECANIQUE CAPACITE 0-25MM LECTURE 1/100MM - REGLAGE SOUPE	512371



/ BALANCE DE PRECISION

Description	Réf.
PRECISION : 0.1GR - JUSQU'A 500 GR	487061



/ PIED A COULISSE DIGITAL

Description	Réf.
PIED A COULISSE DIGITAL POUR MESURE INTERIEURE ET EXTERIEUR -LECTURE 1/100MM - 150MM	512370



/ MULTIMETRE DIGITAL TEST DE CHARGE BATTERIE OU RECHERCHE DE PANNE

Description	Réf.
Multimètre pour mesurer le courant DC, la tension AC / DC, la résistance, le test de diode et la continuité. Livré avec les cordons pointes de touche et coque de protection.	512372





7579



7581



477380

/ PIGE DE CALAGE

Description	SELECTION CGN MOTORISE	BUZZETTI	TUNR
14X125	7579		
MICROMETRIQUE (14X125)		7581	477380



/ OUTIL DE CONTROLE



Description	Réf.
AVANCE ALLUMAGE AVEC COMPARATEUR	508059



/ TESTEUR BOBINE ALLUMAGE



Description	Réf.
	514072



/ CONTROLEUR DE COMPRESSION CYLINDRE A AIGUILLE



Description	Réf.
Ce kit dispose d'une soupape d'échappement rapide de pression et d'une jauge avec une capacité de 300 psi. / 29,5 bars. Kit complet de manomètre avec trois tuyaux de 10-12-14 mm. Mode d'emploi inclus avec le coffret.	505777



/ CONTROLEUR DE PERTE DE PRESSION DANS LE CYLINDRE A AIGUILLE

Description	Réf.
Ce testeur est utile pour la recherche des défauts ou des pertes des soupapes, des pistons, des segments de piston et des joints. La jauge indique la perte en pourcentage en psi. La constante d'injection d'air comprimé permet également d'identifier les défauts à l'écoute. L'ensemble comprend : • Un manomètre, un tuyau avec un embout fileté M14-M18 • Deux réductions M12-M10. • Un connecteur de rallonge. • Mode d'emploi inclus dans le coffret.	505779



/ OUTIL DE DÉMONTAGE



Description	Réf.
OUTIL MONTAGE JOINT SPI POUR PIAGGIO/GILERA/DERBI/APRILIA SCOOTER 50CC 2T COTE ALLUMAGE	491064



/ FER À SOUDER



Description	Réf.
230V BI-WATTS 20-40	514330



FACOM

/ FER À SOUDER GAZ

Description	Réf.
<p>Température de la panne : 250°C ~ 550°. Chalumeau : 1100°C. Température maxi : 1300°C. Allumage par piezo. Contenance en combustible 10 ml. Durée d'utilisation (pour une recharge) 55 min. Pour un demi-remplissage. Temps de chauffe : 40 sec. Puissance : 24 Watts. Dimensions :</p> <ul style="list-style-type: none"> - Avec capuchon : 198 mm. - Longueur : Avec panne : 189 mm. - Avec soufflante de chaleur : 181 mm. <p>Rechargeable au gaz butane (fer livré vide). 4 pannes à souder. 1 distributeur de soudure.</p>	515984



FACOM

/ FER A SOUDER STATION DE SOUDAGE + KIT SOUDURE

Description	Réf.
<p>Station de soudage à température réglable de 150 à 480°C, livrée avec un kit de soudure composé d'une loupe à pince «3ème main», pompe de dessoudage, gratoir, éponge, 3 pannes... Un ensemble complet avec accessoires pour la soudure. Caractéristiques :</p> <ul style="list-style-type: none"> - Température réglable : 150° à 480°C - Panne céramique Diam. 1,2 mm - Puissance fer : 48 W - Livrée avec loupe 3e main 2,5X, pompe à dessouder, brosse, grattoir, étain (10 g), 3 Pannes, éponge, support fer - Dimesions/ Poids : 240x160x100 mm / 1,260 kg 	512618



FACOM

/ DECAPEUR THERMIQUE

Description	Réf.
<p>Bouton marche / arrêt pratique à utiliser avec deux modes :</p> <ul style="list-style-type: none"> - Mode 1: 250 l/min - (50°-400°). - Mode 2: 500 l/min - (50°-600°). <p>- Moteur 2000 Watt durable et puissant. - Excellent contrôle avec un large écran LCD qui facilite la configuration de la température. - Outil compact et léger avec une poignée pistolet facilitant l'utilisation. - Protection de surcharge : l'élément de chauffe s'éteint automatiquement pendant quelques secondes si trop chaud, période durant laquelle l'outil continue de produire de l'air frais. - Outil filaire pour prise de type Europe 220-240 V / 50 Hz. - Prêt à l'emploi : une buse large et une buse à réflecteur sont livrées avec l'outil. - Puissance maxi. : 2000 W. - Alimentation : 220-240 V/50 Hz. - Débit d'air (2 allures) : 250 l/min et 500 l/min. - Livré avec 2 buses : Réf E.2002B1 - E.2002B3.</p> <ul style="list-style-type: none"> • E.2002B1 : Buse large, dim. (Lxhxd) : 75x75x33,7 mm; poids 58 g. • E.2002B3 : Buse à réflecteur, dim. (Lxhxd) : 33x60x33,7 mm; poids 32 g. 	514091



DEWALT

/ DECAPEUR THERMIQUE

Description	Réf.
<ul style="list-style-type: none"> - Une buse conique et une buse large sont livrées en standard pour répondre à une grande diversité d'applications jusqu'aux plus spécifiques - Décapeur thermique robuste grâce à un système de protection contre les surchauffes La mise présence d'un capteur thermique à l'avant du corps de chauffe garanti une durabilité maximum lors des applications intensives - Ce décapeur thermique a été conçu pour des utilisations en poste fixe grâce à des stabilisateurs latéraux rétractables qui assurent un maximum de stabilité et de sécurité - 2 débits d'air pour un excellent contrôle de la température de l'outil dans les applications les plus intensives - Design ergonomique, léger et compact pour assurer encore plus de confort à l'utilisateur et une excellente prise en main <p>Contient :</p> <ul style="list-style-type: none"> - 1 Buse conique - 1 Buse de surface 	514130



514133



514134



/ BOULONNEUSE A CHOCS

Description	Réf.
BOULONNEUSE A CHOCS 1/2" XR 18V DEWALT 203NM (SANS BATTERIE - NI CHARGEUR)	514133
BOULONNEUSE A CHOCS 1/2" XR 18V DEWALT 450NM (SANS BATTERIE - NI CHARGEUR)	514134



/ PERCEUSE VISSEUSE + VISSEUSE A CHOCS

Description	Réf.
Le kombokit contient: Perceuse à visseuse Brushless, Visseuse à chocs Brushless, 2x 3.0Ah batteries, multi-chargeur, Coffret TSTAK II Contient : - 1 Perceuse Visseuse Brushless DCD701 - 1 Visseur à chocs Brushless DCF801 - 2 Batteries 3.0Ah - 1 Chargeurs Multi-voltage - 1 Coffret TSTAK II	514129



/ TOURNEVIS ELECTRIQUE

Description	Réf.
Système gyroscopique à vitesse variable (jusqu'à 430T/min) pour un contrôle parfait Tournevis 7,2V idéal pour les vissages légers Les double LED assurent une visibilité parfaite Poignée ergonomique mobile pour toutes les applications. L'indicateur de charge évite le changement intempestif de batterie en pleine action Réglage de couple à 16 positions permet un contrôle parfait de la profondeur lors de travaux répétitifs Système de porte embout «drop-in» permettant l'utilisation d'embouts courts, emmanchement à une main.	519533



/ VISSEUSE A CHOCS

Description	Réf.
- 33 mm plus court que la génération précédente, ce qui vous permet d'accéder à des espaces encore plus petits. - 3 vitesses électroniques permettent un meilleur contrôle lors du travail sur des opérations précises. - Le mode Precision Drive est idéal pour les travaux de vissage fin, évitant ainsi d'endommager la tête de vis ou le matériau. - 20% de temps d'exécution en plus par rapport à la génération précédente. - Seulement 0.9kg (outil) pour une portabilité ultime. - Porte-outil 'Drop and Load' pour utilisation d'une seule main - Moteur Brushless pour plus de performances et d'autonomie Contient : - 1 Clip ceinture - 2 Batteries XR 12V 2A - 1 Chargeur multi voltage DCB112 - 1 Coffret TSTAK	514128



DEWALT

/ MEULEUSE 1400W 125MM

Description	Réf.
<p>1400 W 125 MM INTERRUPTEUR GLISSIERE</p> <ul style="list-style-type: none"> - Le système anti-redémarrage évite à la machine de redémarrer accidentellement après une coupure de courant. - L'interrupteur doit être remis en position initiale avant de pouvoir redémarrer le moteur. - Carter de protection réglable rapidement, sans outil - Boîte d'engrenage avec profil surbaissé afin de pouvoir travailler dans des espaces limités - Inducteur avec fils de connexion directement tirés du bobinage, pour une meilleure durée de vie de l'outil - Moteur protégé contre l'abrasion des particules de poussière, pour une plus grande longévité - Poignées caoutchoutées assurant une meilleure prise en main - Système de blocage de l'arbre situé sur le côté, permet de travailler dans des espaces restreints - Nouveau système de serrage du disque, évite le blocage - Système d'éjection de la poussière, enlève la majorité des débris, protège le moteur des particules - Un moteur encore plus résistant pour répondre aux applications les plus exigeantes. - Le démarrage progressif offre plus de sécurité et un meilleur contrôle à l'utilisateur - Charbons autorupteurs pour une plus grande durée de vie du moteur <p>Contient :</p> <ul style="list-style-type: none"> - 1 Clé de service - 1 Poignée latérale multi-positions - 1 Flasque intérieur/extérieur - 1 Carter de protection sans outil 	514132



DEWALT

/ MEULEUSE 800W DEWALT 125MM

Description	Réf.
<p>800 W 125 MM INTERRUPTEUR GLISSIERE</p> <p>Le système anti-redémarrage évite à la machine de redémarrer accidentellement après une coupure de courant. L'interrupteur doit être remis en position initiale avant de pouvoir redémarrer le moteur</p> <ul style="list-style-type: none"> - Meuleuse compacte assurant une meilleure prise en main - Blocage de l'arbre positionné sur la tête de la meuleuse pour maximiser la profondeur de meulage - Conception indépendante et facile d'accès des charbons pour plus de durée de vie - 100% de roulements à billes pour plus d'efficacité et de durabilité - Boîte d'engrenage avec profil surbaissé afin de pouvoir travailler dans des espaces limités - Le démarrage progressif offre plus de sécurité et un meilleur contrôle à l'utilisateur - Charbons autorupteurs pour une plus grande durée de vie du moteur - Inducteur avec fils de connexion directement tirés du bobinage, pour une meilleure durée de vie de l'outil - Moteur protégé des particules abrasives pour une plus grande durée de vie <p>Contient :</p> <ul style="list-style-type: none"> - 1 Clé de service - 1 Flasque intérieur/extérieur - 1 Poignée latérale multi-positions - 1 Carter de protection 	514131



DEWALT

/ PERCEUSE

Description	Réf.
<p>PERCEUSE VISSEUSE XR 18V 5AH LI-ION BRUSHLESS (2 BATTERIES + CHARGEUR + COFFRET 25 PCS)</p>	523498



DEWALT

/ BATTERIE

Description	Réf.
BATTERIE XR 12V 3AH LI-ION DEWALT (X1)	514136
BATTERIE XR 18V 2AH LI-ION DEWALT (X1)	514137
PACK 2 BATTERIES XR 18V 5AH LI-ION + CHARGEUR DEWALT	514135



484548



484549



515753

/ DISQUE MEULEUSE/LAPIDAIRE

Description	TIVOLY	SELECTION CGN MOTORISE
A TRONCONNER ACIER ET INOX DIAMETRE 115 EPAISSEUR 1.6 MM	484548	
A TRONCONNER ACIER ET INOX DIAMETRE 125 EPAISSEUR 1.6 MM	484549	
A TRONCONNER ET MEULER ACIER ET INOX DIAMETRE 125 EPAISSEUR 1.9		515753



520185



520185



520185



520186



/ BROSSSE

Description	TIVOLY
BROSSE PINCEAU TIVOLY FIL ACIER LAITONNÉ DIA.24	520185
BROSSE PINCEAU TIVOLY FIL ACIER ONDULÉ DIA.28	520186
BROSSE COUPE TIVOLY FIL INOX DIA.75	520184
BROSSE CIRCULAIRE TIVOLY FIL ACIER LAITONNÉ DIA.70	520183



511988



514327

/ BROSSSE METALLIQUE

Description	BLACKWAY	FACOM
BOUGIE	511988	
ACIER		514327



/ SAC A OUTILS

Description	Réf.
SAC À OUTILS TEXTILE 20" RENFORCÉE FACOM BS.T20PB Description catalogue outillage Facom référence : BS.T20PB • Boîte à outils textile Grand modèle 20". • Résistance et confort. • Tissu très résistant polyester 1200 x 1200 deniers. • Soute en polypropylène rigide et waterproof. • Poignée aluminium avec poignée de préhension en cuir. • Sangle d'épaule avec coussin de renfort au niveau de l'épaule. Mousquetons d'attaches de la bandoulière en métal inoxydable. • Fermeture par capote souple • Poche kangourou intégrée pour le rangement de la capote • Rangement pratique. • Rangement vertical pour un accès immédiat aux outils. • Sangle élastique de maintien des outils. • Rack latéral dédié aux tournevis et chasse-goupilles. • Nombreuses poches latérales. • Compartiment scie ajustable par bande auto-adhésive. • Volume utile de rangement : 47 litres. • Charge utile de rangement : 15 kg. • Dimensions hors tout (L x l x H) : 52 x 25 x 36 cm. • Poids : 2,797 kg.	517736
Caractéristiques techniques outillage Facom référence : BS.T20PB • Volume utile de rangement : 47 litres. • Charge utile de rangement : 15 kg. • Dimensions hors tout (L x l x H) : 52 x 25 x 36 cm. • Poids : 2,797 kg.	



/ CAISSE A OUTILS

Description	Réf.
Fond des compartiments recouvert de mousse. Écartement maxi des poignées : accès instantané à toutes les cases. Charge maxi : 30 kg. Dimensions : 470 x 220 x 215 mm.	514361



/ SERVANTE ATELIER

Description	Réf.
<p>SERVANTE ATELIER ROLL 6 TIROIRS ROLL ROUGE 3 MODULES PAR TIROIR</p> <p>Servante 6 tiroirs : 3 tiroirs hauteur 60 mm. 2 tiroirs hauteur 130 mm. 1 tiroir d'une hauteur : 200 mm. Les tiroirs peuvent être équipés de tous les modules thermoformés ou mousse du programme Facom Modular system (Capacité de 15 modules répartis dans les tiroirs de 60 et 130 mm, Les tiroirs de 200 peuvent également recevoir des modules.) Charge maxi par tiroir : 20/25/30kg Plan de travail : Grand plan de travail en polypropylène chargé fibre (résistance à une charge statique de 700kg), rebords intégrés évitant la chute d'outils en cours de déplacement. Résistance aux impacts et aux hydrocarbures. 2 poignées intégrées, une pour le déplacement et une autre permettant de soulever la servante pour le passage d'obstacles. Emplacement dédié pour 3 tournevis. Sécurité : Façade de tiroirs basculante en polypropylène avec crochets de sécurité. Pas de risque d'ouverture en cours de déplacement. Serrure positionnée sur le côté. Condamnation centralisée par serrure à clé, livrée avec 2 clés dont 1 articulée</p>	514362



/ ETABLI ATELIER PLATEAU BOIS 6 TIROIRS

Description	Réf.
<p>(LONGUEUR 2 METRES) SUR COMMANDE</p> <p>Bloc de rangement 6 tiroirs : - 3 tiroirs hauteur 60 mm. - 2 tiroirs hauteur 130 mm. - 1 tiroir d'une hauteur : 200 mm.</p> <p>Les tiroirs peuvent être équipés de tous les modules thermoformés ou mousse du programme Facom Modular system.</p> <p>Charge maxi par tiroir : 20/25/30 kg. Façade de tiroirs basculante en polypropylène avec crochets de sécurité. Serrure positionnée sur le côté, condamnation centralisée par serrure à clé, livrée avec 2 clés dont 1 articulée</p> <p>Piètement : En tôle d'acier profilée en U ; Possibilité de fixation au sol.</p> <p>Plan de travail : - Hêtre multi-plis épaisseur 40 mm ; Possibilité de fixation d'un étau. - Résistance statique, charge répartie : 1 tonne. Accessoires : - Support flacons inclus (positionnable à droite ou à gauche). - Côtés du bloc tiroir perforés pour recevoir les accessoires de la gamme JET.XL. - Cloisons métalliques en option (JET2.15 pour les tiroirs de 60 mm et JET2.16 pour les tiroirs de 130 mm).</p> <p>Montage facile et rapide. Dimensions utiles des tiroirs (L. x P. x H.) : 569 x 421.</p>	514397



/ ETABLI ATELIER PLATEAU GALVA

Description	Réf.
<p>(LONGUEUR 2 METRES) SUR COMMANDE</p> <p>Plan de travail en tôle galvanisée épaisseur 2.5 mm résistant aux chocs et à la chaleur. Construction métallique soudée et boulonnée très robuste. Résistance statique : 700 kg. Rebords anti-chute sur 3 côtés. Possibilité de fixation au sol. Peut recevoir 2 tiroirs additionnels WB.DRAWERPB. Large traverse faisant office d'étagère ou de repose-pieds. Montage facile et rapide.</p>	514396



/ ETAU D'ETABLI

Description	Réf.
125 MM, FIXE.	514123





/ ENTONNOIR



Description	Réf.
ENTONNOIR RECTANGULAIRE AVEC FILTRE EXTRA FIN (CAPACITE 4 LITRES)	490733



/ CLE A FILTRE A RUBAN



Description	Réf.
POUR FILTRE A HUILE DIAMETRE 60 A 105MM	494789
POUR FILTRE A HUILE DIAMETRE 65 A 105MM MANCHE PLASTIQUE	504314



FACOM
/ CLE A FILTRE

Description	Réf.
Clé à sangle pour véhicules de tourisme. Longueur maxi. : 260 mm (pour les filtres diam. : 65 --> 105 mm). Sangle de rechange U.46-2A pour clé à filtres à huile.	514331
Pour les filtres de diam. : 66 --> 105 mm. Angle de reprise de l' effet cliquet : 5°. Serrage automatique de la sangle. Sangle de rechange U.48-2 pour clé à filtres à huile.	514365

FACOM
/ CLE A FILTRE



Description	Réf.
SANGLE DE RECHANGE POUR CLE A FILTRE 514331	514332



/ CLE SANGLE



Description	Réf.
CLE SANGLE TUN'R SERRE VOLANT/CLOCHE/TAMBOUR/FILTRE A HUILE	449781



/ CLE A FILTRE



Description	BUZZETTI
POUR FILTRE A HUILE DIAMETRE 49MM - SPECIAL PIAGGIO 125 / 300 CC	482145
POUR FILTRE A HUILE DIAMETRE 76MM - SPECIAL PIAGGIO 300 / 400 / 500 CC	495075



/ CLE A FILTRE

Description	BUZZETTI
POUR FILTRE A HUILE DIAM. 65 A 67MM - 14 PANS	481845
POUR FILTRE A HUILE DIAM. 68MM - 14 PANS	481846
POUR FILTRE A HUILE DIAM. 74 A 76MM - 15 PANS	481847
POUR FILTRE A HUILE DIAM. 76MM - 14 PANS	481848
POUR FILTRE A HUILE DIAM. 61 A 97MM - REGLABLE	481371



/ SOUFFLETTE PROGRESSIVE + RACCORD



Description	Réf.
4M SPIRALE	491106



/ ENROULEUR AIR PNEUMATIQUE 9M ABS RENFORCE

Description	Réf.
D INT 8/PRESSION MAX 12 BAR/RACCORD 1/4"G MALE	490736



/ PISTOLET DE GONFLAGE AVEC MANOMETRE

Description	Réf.
	215298



/ EMBOUT DE GONFLAGE

Description	Réf.
EMBOUT DE GONFLAGE SCHRADER TYPE MICHELIN POUR FLEXIBLE DIAM 5 MM (LAITON)	483140
EMBOUT DE GONFLAGE SCHRADER TYPE MICHELIN POUR FLEXIBLE DIAM 7 MM (LAITON)	483141



524559



518743



518744



518741



518742

/ DETERGENT NETTOYEUR/BAC ULTRASON

Description	BONDERITE	BPAC
BONDERITE 5L	524559	
DD03 1L		518743
DD03 5L		518744
MECA33 1L		518741
MECA33 5L		518742



518739



518740



518737



518738



/ NETTOYEUR/BAC ULTRASON

Description	Réf.
6 LITRES ANALOGIQUE 180 WATTS AVEC VANNE DE VIDANGE 300X150X150MM	518737
6 LITRES DIGITAL 180 WATTS AVEC VANNE DE VIDANGE 300X150X150MM	518738
15 LITRES ANALOGIQUE 360 WATTS AVEC VANNE DE VIDANGE 330X300X150MM	518739
28 LITRES ANALOGIQUE 600 WATTS AVEC VANNE DE VIDANGE 500X300X200MM	518740

Vulcanet®

/NETTOYANT / DEGRAISSANT



Description	Réf.
Un détergent carrosserie, nettoyant pollutions et hydrocarbures, Un dégoudronnant, Un nettoyant vitre, anti-pluie, sans traces, Un nettoyant jantes, éliminant graisses et poussières de frein, Un démoustiquant phares, calandre et parebrise, Un lustrant peintures fanées et protection contre les salissures, Son tissage alvéolé capture la salissure, Vulcanet® s'utilise partout, ne nécessite aucun lieu équipé, ou évacuation d'eau usée. Sans rinçage & Sans Eau. Vendu avec 1 microfibre	528883

PINLOCK

/NETTOYANT INTERIEUR CASQUE



Description	Réf.
INTERIOR FRESH (PULVERISATEUR 100 ML)	515582



/NETTOYANT/DEGRAISSANT



Description	Réf.
THREEBOND 6950 ATELIER MULTI USAGES (SCEAU 500 LINGETTES)	504381



/PRODUIT DETERGENT



Description	Réf.
SPECIAL TABLIER - 306BOX	507558

LOCTITE

/SAVON NETTOYANT MAIN



Description	Réf.
7850 (3L) 3.4 KGS	390436

LOCTITE

/NETTOYANT/DEGRAISSANT



Description	Réf.
7840 MULTI USAGES (SPRAY 750 ML)	503920



/SAVON NETTOYANT MAIN EN PATE



525891



525892

Description	Réf.
AVEC LANOLINE (4L)	525891
BLANC SUPER CONCENTRÉ (4L)	525892



/ABSORBANT HYDROCARBURE



Description	Réf.
SAC DE 20 KG	487034



/ GANT ATELIER JETABLE DOPPLER

Description	Réf.
T 8 (M) NITRILE HAUTE RESISTANCE (BOITE DE 50) - NOIR	526689
T 9 (L) NITRILE HAUTE RESISTANCE (BOITE DE 50) - NOIR	526690
T10 (XL) NITRILE HAUTE RESISTANCE (BOITE DE 50) - NOIR	526691



/ CROCHET PORTE BOBINE PAPIER

Description	Réf.
TOUT TYPE DE ROULEAU DE PAPIER	518461



/ BOBINE PAPIER ESSUIE MAINS

Description	Nbre Pièces	Réf.
BLANC 100 % RECYCLE ROULEAU 300M MADE IN FRANCE	x2	487813
OUATE ROULEAU 300M MADE IN FRANCE	x2	485116



/ CHIFFON JETABLE

Description	Réf.
RESISTANT ET ABSORBANT - BALLE DE 10 KGS	508576



OSRAM

/ LAMPE ATELIER

Description	Réf.
200 LUMENS POCKET 200 (RECHARGEABLE USB)	518027



524260

/ BOUCHON SILENCIEUX/CARTOUCHE

Description	Réf.
POUR NETTOYAGE MOTO Ø19-38 MM	524260
POUR NETTOYAGE MOTO Ø24-48 MM	524261



504615

/ BOUCHON SILENCIEUX / CARTOUCHE

Description	Réf.
POUR NETTOYAGE MOTO DIAMETRE 18-34 MM	504615
POT ECHAPPEMENT POUR NETTOYAGE MOTO DIAMETRE 31-57 MM	504614



/ BEQUILLE

Description	Réf.
BÉQUILLE AVANT SOUS T DE FOUCHE AVEC LEVIER - LIVRÉ AVEC BROCHE UNIVERSELLE ET AVEC PLAQUE	519463



486794

503343

/LEVE MOTO/BEQUILLE/SUPPORT UNIVERSEL

Description	Réf.
H REPOS 290 MM/H LEVE 370 MM	486794
H REPOS 300 MM/H LEVE 410 MM	503343



/ETAU DE ROUE/SUPPORT

Description	Réf.
MOTO/SCOOTER AUTOBLOQUANT 3 POSITIONS DE REGLAGE. POUR MOTO ÉQUIPÉE DE ROUES DE 16 À 21 POUCES	503935



508712

508703

/ LEVE MOTO/BEQUILLE/SUPPORT UNIVERSEL

Description	Réf.
HYDRAULIQUE REPOS 250 MM/ LEVE 460 MM	508712
QUAD ATELIER HYDRAULIQUE CAPACITE 680 KG	508703



505613

503342

/LEVE MOTO/BEQUILLE

Description	Réf.
ATELIER AR UNIVERSEL RENFORCE AVEC SUPPORT CAOUTCHOUC - ROUGE. - Largeur max : 310 mm (entre les supports caoutchouc) - Largeur min : 210 mm (entre les supports caoutchouc)	505613
ATELIER AV/AR UNIVERSEL AVEC SUPPORT CAOUTCHOUC ET EN V - ROUGE. - Pour l'avant largeur min : 160 mm et max : 235 mm - Pour l'avant largeur min : 170 mm et max : 270 mm	503342



/ BEQUILLE DE STAND AR MECABOITE / MOTO

Description	Réf.
TRIANGLE UNIVERSEL - ACIER	505630



/ ROULEAU MECABOITE / MOTO

Description	Réf.
POUR GRAISSAGE CHAÎNE ET MAINTENANCE	505614



/ LEVE MOTO/BEQUILLE ATELIER AR

Description	Réf.
UNIVERSEL SPECIALE 50 ET 125 CC. Bras oscillant : écartement de 160 mm à 250 mm	503340



517629



517691



517630



517627



517692



517628



/ SANGLE DE TRANSPORT

Description	Réf.
SANGLE DE TRANSPORT/ARRIMAGE A BOUCLE BLACKWAY (1 PC) - SPECIFIQUE GUIDON	517691
SANGLE DE TRANSPORT/ARRIMAGE A BOUCLE BLACKWAY (X1)	517627
SANGLE DE TRANSPORT/ARRIMAGE A BOUCLE BLACKWAY (X2)	517628
SANGLE DE TRANSPORT/ARRIMAGE A CLIQUET MOTO BLACKWAY (X1)	517629
SANGLE DE TRANSPORT/ARRIMAGE A CLIQUET MOTO BLACKWAY (X2)	517630
SANGLE DE TRANSPORT/ARRIMAGE BLACKWAY (1 PC) - SPECIFIQUE ROUE/PNEU	517692



/ TAPIS

Description	Réf.
TAPIS ENVIRONNEMENTAL MOTO STAGE6 MK2 (200x100CM -NORME FIM ET SVEMO)	518535



/ TAPIS

Description	Réf.
TAPIS ENVIRONNEMENTAL MOTO DOPPLER (200x100CM -NORME FIM ET SVEMO)	524246



504616



504617

/ BLOQUE FOURCHE MOTO

Description	Réf.
GRAND MODELE - 253MM	504616
PETIT MODELE - 180MM	504617



**/SUPPORT POUR
LEVE MOTO/BEQUILLE**



Description	Réf.
SUPPORT «L» POUR LEVE MOTO/BEQUILLE ATELIER AR UNIVERSEL	505993
SUPPORT «V» POUR LEVE MOTO/BEQUILLE ATELIER AR UNIVERSEL (POUR DIABOLO) CARRE 20X20	505994



**/PATE A PNEU BLANCHE
MONTAGE PNEU**



Description	Réf.
SEAU 1KG	492376



/PATE A PNEU



Description	Réf.
MONTAGE PNEU - SEAU 1KG - BLANCHE	211197
MONTAGE PNEU - SEAU 1KG - NOIRE	491462



/ SUPPORT MOTO PLIABLE

Description	Réf.
SUPPORT/BEQUILLE MOTO POLISPORT PLIABLE POUR STAND (MAINTENANCE) ORANGE CHARGE MAXI 250KG	483122
SUPPORT/BEQUILLE MOTO POLISPORT PLIABLE POUR STAND (MAINTENANCE) ROUGE CHARGE MAXI 250KG	483124
SUPPORT/BEQUILLE MOTO POLISPORT PLIABLE POUR STAND (MAINTENANCE) VERT CHARGE MAXI 250KG	483125



**/PATE A PNEU MONTAGE
PNEU TUBELESS**



Description	Réf.
SCEAU 1KG	493866



/OUTIL MONTAGE PNEU



Description	Réf.
PINCEAU POUR PATE A PNEU	211288



**/DECOLLE/DEMONTE
PNEU MANUEL**



Description	Réf.
ATELIER/MOBILE - NOIR	505989



/MEULE REPARATION PNEU



Description	Réf.
PIERRE SPHERIQUE D40MM	211182

MOTEUR

CYCLE

PNEUMATIQUE

ATELIER

ACCESSOIRES

ÉLECTRICITÉ

FILTRATION

FREINAGE

TRANSMISSION



/MECHE INTERIEUR

Description	Nbre Pièces	Réf.
REPARATION PNEU A3 TIGE. D.3.5 MM DIAM. RUSTINE 23 MM	x50	211273
REPARATION PNEU A3 TIGE 3.5MM DIAM. RUSTINE 23 MM	x5	482762
REPARATION PNEU A6 TIGE D.7 MM DIAM. RUSTINE 40MM	x40	215499



/MECHE/TRESSE KIT REPARATION PNEU

Description	Réf.
PM (LG 100MM) (X50)	440130



/CHEVILLE REPARATION PNEU

Description	Réf.
CHEVILLES RAS RECHARGE (X40)	210205



/MECHE/TRESSE)

Description	Nbre Pièces	Réf.
PNEU SEALFIX (X5)	x5	521107



/NECESSAIRE REPARATION PNEU TUBELESS

Description	Nbre Pièces	Réf.
MECHE/TRESSE	x5	171628



/NECESSAIRE REP/RUSTINE

Description	Réf.
CHAMBRE A AIR TTII (7 RUSTINES)	5013



/RAPEUR/BUFFER CHIMIQUE

Description	Réf.
AEROSOL 500 ML	281164



/NECESSAIRE REPARATION TUBELESS

Description	Nbre Pièces	Réf.
TRESSE/MECHE	x3	440129



/SPECIAL CEMENT BL

Description	Réf.
REPARATION VULCANISATION/COLLE PNEU (BIDON 200G)	211216
REPARATION VULCANISATION/COLLE PNEU (TUBE 70G)	211227
REPARATION VULCANISATION/COLLE PNEU (TUBE 30G)	211235



/PRODUIT ETANCHEITE/STOP FUITE

Description	Réf.
BEAD SEALER POUR PNEU TUBELESS (1L)	211201



/DETECTEUR DE FUITE

Description	Réf.
(AEROSOL 400ML) TYPE 1000 BULLES	211240



/BOMBE ANTI-CREVAISON

Description	Réf.
SCOOTER/MOTO (AEROSOL 200ML)	5051
SCOOTER/MOTO/AUTO (AEROSOL 300ML)	388569



/MASSE/PLOMB EQUILIBRAGE ADHESIVE

Description	Nbre Pièces	Réf.
POUR ROUE (BARETTE 4X5GR - 4X10GR)	x100	521106



/MASSE/PLOMB EQUILIBRAGE ADHESIVE

Description	Réf.
POUR ROUE - BARETTE 4X5GR - 4X10GR	493340



/ OUTIL DEMONTE OBUS

Description	Réf.
OUTIL DEMONTE OBUS DE VALVE L*95MM	480442



/ TIRE VALVE ET DEMONTE OBUS

Description	Réf.
TIRE VALVE ET DEMONTE OBUS	518376



/ VALVE

Description	Réf.
OUTIL REPARATION VALVE TYPE SCHRADER AVEC DEMONTE OBUS/TIRE VALVE	484971



/ TIRE VALVE ET DEMONTE OBUS JANTE

Description	Réf.
TIRE VALVE ET DEMONTE OBUS JANTE TUBELESS	483333



/ PROTECTION DE JANTE

Description	Réf.
SCOOTER/MECABOITE/MOTO DEMONTE PNEU	494245





/ DEMONTE PNEU

Description	Réf.
PROFESSIONNEL - 200MM (JEU DE 3)	449966
PROFESSIONNEL - 240MM (JEU DE 3)	465276
PROFESSIONNEL TYPE FUSIL 2 DE 350MM + 1 DE 240MM (JEU DE 3)	482664



/ PATE A JOINT

Description	Réf.
110H (TUBE 50G) BLANC	504370
1184 (TUBE 200G) GRIS	504373
1207B (TUBE 100G) NOIR	504371
1215 (TUBE 250G) GRIS	504372



/ PATE A JOINT

Description	Réf.
ELRING (TUBE 70ML) GRISE (300°)	481487
ELRING (TUBE 70ML) ROUGE (315°)	481488



/ PATE A JOINT

Description	Réf.
510 (SERINGUE 25ML) (ALU/ALU)	279134



/ PATE A JOINT

Description	Réf.
518 GEL ROUGE (STYLO APPLICATEUR 25ML)	503919



/ PATE A JOINT SILICONE

Description	Réf.
5660 GRIS (TUBE 40ML)	279172
5910 NOIR (CARTOUCHE 100ML)	501941
5910 NOIR (TUBE 40ML)	493800
5926 BLEU (TUBE 100ML)	279168
5926 BLEU (TUBE 40ML)	484613



/ PATE A JOINT

Description	Réf.
CAF 1 (TUBE 100G) ROUGE	2374
CAF 4 (TUBE 100G) BLANCHE	168917



/ PATE A JOINT

Description	Réf.
TUBE 70ML - NOIR (315°)	516952



LOCTITE

/ PRODUIT ANTI-FUITE RADIATEUR

Description	Réf.
BIDON 250ML	484614



LOCTITE

/OUTIL REPARATION/FIXATION

279005 492217

Description	Réf.
401 COLLE SUPER GLUE 3 (TUBE 3G) ADHESIF INSTANTANEE	279005
401 COLLE TYPE SUPER GLUE (TUBE 5G) ADHESIF INSTANTANE	492217



/ COLLE

504380

504377

504378

504379

Description	Réf.
COLLE ADHESIVE NEOPRENE THREEBOND 1521 (TUBE 150G) - SPECIALE REVETEMENTS/POIGNEE	504380
COLLE POLYMERE THREEBOND 1533C (TUBE 23G) -	504377
COLLE THREEBOND 1786 SUPER FORTE CYANOACRYLATE (FLACON 20G)	504379
COLLE THREEBOND 1786 SUPER FORTE CYANOACRYLATE (TUBE 3G)	504378



LOCTITE

/COLLE

Description	Réf.
454 TYPE SUPER GLUE GEL (TUBE 5G) ADHESIF INSTANTANE	503921



LOCTITE

/COLLE BI-COMPOSANTS

Description	Réf.
3090 COLLE BI-COMPOSANTS PLASTIQUE (SERINGUE 10ML)	484616



LOCTITE

/ COLLE

494114 279081 279058

Description	Réf.
641 COLLE ROULEMENT BLOCPRESSE (FLACON 50ML)	494114
648 COLLE ROULEMENT BLOCPRESSE (FLACON 24ML)	279081
648 COLLE ROULEMENT BLOCPRESSE (TUBE 5ML)	279058



LOCTITE

/COLLE

Description	Réf.
HY4070 COLLE BI COMPOSANT PLASTIQUE (SERINGUE 11 G)	524558

ThreeBond

/ FREIN FILET THREEBOND



504374

504375

504376

Description	Réf.
1305 RESISTANCE FORTE (FLACON 50G) - VERT	504374
1327 RESISTANCE MOYENNE (FLACON 50G) - ROUGE	504375
1344E RESISTANCE NORMALE (FLACON 50G) - BLEU	504376



279010 484617 496870 484618



/ FREIN DE FILET

Description	Réf.
243 FREIN FILET RESISTANCE NORMALE (TUBE 5ML)	279010
248 FREIN FILET RESISTANCE MOYENNE (STICK 9G)	484617
271 FREIN FILET RESISTANCE FORTE (FLACON 24ML)	496870
271 FREIN FILET RESISTANCE FORTE (FLACON 5ML)	484618



/ PATE EPOXY

Description	Réf.
3450 EPOXY ACIER POXYMATIC (SERINGUE 24ML)	279115
3455 EPOXY ALU POXYMATIC (SERINGUE 24ML)	279120



/ RUBAN ADHÉSIF AMERICAIN MULTI REPARATION

Description	Réf.
48MM x 25M (ROULEAU) - GRIS	506873
48MM x 25M (ROULEAU) - NOIR	506871
48MM x 25M (ROULEAU) - ROUGE	506872
48MM x 50M (ROULEAU) - GRIS + OFFRE WD40	520347
48MM x 50M (ROULEAU) - NOIR + OFFRE WD40	520346
48MM x 5M (ROULEAU) - BLANC	500249
48MM x 5M (ROULEAU) - GRIS	500248
48MM x 5M (ROULEAU) - NOIR	288279



/ RUBAN ADHÉSIF ALUMINIUM

Description	Réf.
50MM X 5M (ROULEAU)	506874



/ RUBAN ADHÉSIF DOUBLE FACE

Description	Réf.
19MM X 2M (ROULEAU)	506877



/ RUBAN ADHÉSIF ISOLANTE

Description	Réf.
19MM x 10M (ROULEAU) NOIR	520618



/ RUBAN ADHÉSIF TEXTILE PROTECTEUR

Description	Réf.
19MM X 25M (ROULEAU) - NOIR	506879



/ RUBAN ADHÉSIF SPECIAL EMBALLAGE

Description	Réf.
50MM x 66M (ROULEAU) BRUN	506876
50MM x 66M (ROULEAU) TRANSPARENT	506875



/ BANDE CACHE/RUBAN DE MASQUAGE

Description	Réf.
19MM X 50M (ROULEAU) - BLANC/CREME	506880
50MM X 50M (ROULEAU) - BLANC/CREME	506881



/ RUBAN ADHÉSIF VULCANISATION

Description	Réf.
19MM X 10M (ROULEAU) - NOIR	506878



/ COLLIER RILSAN PLASTIQUE



Description	Nbre Pièces	Réf.
BLANC LONG 2,6X200 MM	x100	499075
BLANC LONG 3,6X250 MM	x100	499069
BLEU LONG 2,6X200 MM	x100	499076
BLEU LONG 3,6X250 MM	x100	499070
JAUNE LONG 2,6X200 MM	x100	499078
JAUNE LONG 3,6X250 MM	x100	499073
NOIR LONG 3,6X250 MM	x100	508594
NOIR LONG 4X200 MM	x100	491612
NOIR LONG 4,8X250 MM	x100	491613
NOIR TYPE SIGMA COURT 2,5X95 MM	x100	482849
NOIR TYPE SIGMA LONG 2,6X200 MM	x100	482848
ORANGE LONG 2,6X200 MM	x100	499079
ORANGE LONG 3,6X250 MM	x100	499074
ROUGE LONG 3,6X250 MM	x100	499071
TRANSPARENT LONG 3,6X250 MM	x100	516930
TRANSPARENT LONG 4,8X200 MM	x100	516932
VERT LONG 2,6X200 MM	x100	499077
VERT LONG 3,6X250 MM	x100	499072
NOIR COURT 2,5 x 95 MM	x100	479106
NOIR LONG 2,6 x 200 MM	x100	479105



/ COFFRET COLLIER RILSAN PLASTIQUE



Description	Réf.
(BOITE DE 250 PCS - 2,5X100MM + 4,8X160MM - NOIR + TRANSPARENT)	504936



/ PAPIER À PONCER À L'EAU

Description	Réf.
P120 (23CMX28CM)	491809
P240 (23CMX28CM)	491810
P400 (23CMX28CM)	491811
P600 (23CMX28CM)	491812
P1000 (23CMX28CM)	520625



/FRAMETO

Description	Réf.
7503 PONCABLE SPECIAL RETOUCHE ANTI ROUILLE (TUBE 12ML)	491806



/FRAMETO

Description	Réf.
RUBSON TRAITEMENT HAUTE RESISTANCE ANTI ROUILLE (TUBE 90ML)	491804



/PATE A RODER

Description	Réf.
VR2200 (BOITE 100ML)	524560



/ GRAISSE CUIVRE

Description	Réf.
8008 ANTI GRIPPAGE (POT 113GR)	503918



/ GRAISSE CUIVRE

Description	Réf.
8065 ANTI GRIPPAGE (STICK 20GR)	503923



/PURGEUR PNEUMATIQUE

Description	Réf.
POUR CIRCUIT DE FREIN (KIT)	498811



/PURGEUR

Description	Réf.
POUR CIRCUIT DE FREIN (KIT)	484628





/ OUTIL DEMONTE/PINCE/EXTRACTEUR PISTON ETRIER FREIN

Description	Réf.
DIAMETRE DE 17.3 A 33.8MM	496356



/ OUTIL ECARTEUR PLAQUETTE DE FREIN

Description	SELECTION CGN MOTORISE	TUNR
	477411	
REPOUSSE PISTON ETRIER FREIN		476159



/ JOINT BOUCHON VIDANGE MOTO

Description	Réf.
COFFRET PANACHE DE M10 A M24 BOITE DE 110 PIECES : 15 joints : M10 - 15 joints : M12 - 15 joints : M14 - 15 joints : M16 - 15 joints : M18 - 15 joints : M20 - 10 joints : M22 - 10 joints : M24	509533



/ BAC VIDANGE/ RECUPERATEUR FLUIDE

Description	BUZETTI	CGN
BAC 2L	484622	
BAC 8L		517683
BAC 10L		517682



/ CLAPET ANTI-RETOUR



Description	Réf.
POUR PURGE FREIN/CIRCUIT HYDRAULIQUE	484629

495308	495309	495310	527396	527397
527398	527399	527404	527405	527406
527407	527408	527409	527410	527400
527401	527411	527412	527394	527395
			527402	527403



/ JOINT BOUCHON VIDANGE MOTO X1

Description	Réf.
DIAM. 8X12MM - EPAISSEUR 1.00MM - CUIVRE	527394
DIAM. 8X14MM - EPAISSEUR 1.00MM - CUIVRE	527395
DIAM. 10X14MM - EPAISSEUR 1.00MM - CUIVRE	527396
DIAM. 10X16MM - EPAISSEUR 1.00MM - CUIVRE	527397
DIAM. 12X18MM - EPAISSEUR 1.50MM - CUIVRE	527398
DIAM. 12X20MM - CUIVRE	495309
DIAM. 14X20MM - CUIVRE	495308
DIAM. 16X22MM - CUIVRE	495310
DIAM. 18X24MM - EPAISSEUR 1.50MM - CUIVRE	527399
DIAM. 20X26MM - EPAISSEUR 1.50MM - CUIVRE	527400
DIAM. 24X30MM - EPAISSEUR 1.50MM - CUIVRE	527401
DIAM. 8X12MM - EPAISSEUR 1.50MM - ALU	527402
DIAM. 8X14MM - EPAISSEUR 1.50MM - ALU	527403
DIAM. 10X14MM - EPAISSEUR 1.50MM - ALU	527404
DIAM. 10X16MM - EPAISSEUR 1.50MM - ALU	527405
DIAM. 12X18MM - EPAISSEUR 1.50MM - ALU	527406
DIAM. 12X20MM - EPAISSEUR 1.50MM - ALU	527407
DIAM. 14X20MM - EPAISSEUR 1.50MM - ALU	527408
DIAM. 16X22MM - EPAISSEUR 1.50MM - ALU	527409
DIAM. 18X24MM - EPAISSEUR 1.50MM - ALU	527410
DIAM. 20X26MM - EPAISSEUR 1.50MM - ALU	527411
DIAM. 24X30MM - EPAISSEUR 1.50MM - ALU	527412



/ JOINT BOUCHON VIDANGE

Description	Réf.
BOITE AM6 Ø 8 x 12 MM CUIVRE	483805
BOITE DERBI SENDA/GPR EURO2/EURO3/EURO4 Ø 10 x 18 MM CUIVRE	484774
MOTO Ø 12 x 20 MM CUIVRE	495309
MOTO Ø 14 x 20 MM CUIVRE	495308
MOTO Ø 16 x 22 MM CUIVRE	495310



/ BOUCHON VIDANGE AIMANTÉ

Désignation	Réf.
M10X1.25 -16MM - NOIR AVEC JOINT CUIVRE	513583
M10X1.5 -15MM - NOIR AVEC JOINT CUIVRE	513584
M10X1.5 -22MM - NOIR AVEC JOINT CUIVRE	513585
M12X1.25 -10MM - NOIR AVEC JOINT CUIVRE	513586
M12X1.5 -12MM - NOIR AVEC JOINT CUIVRE	513588
M12X1.5 -15MM - NOIR AVEC JOINT CUIVRE	513587
M8X1.25 -15MM - NOIR AVEC JOINT CUIVRE	513579
M8X1.25 -20MM - NOIR AVEC JOINT CUIVRE	513580
M8X1.25 -25MM - NOIR AVEC JOINT CUIVRE	513581
M8X1.25 -35MM - NOIR AVEC JOINT CUIVRE	513582
M8X1.5 -16MM - NOIR AVEC JOINT CUIVRE	513589



/ JOINT BOUCHON VIDANGE CARTER MOTEUR



Désignation	Réf.
JOINT BOUCHON VIDANGE CARTER MOTEUR MAXI SCOOTER OEM 125 XMAX/MBK SKYCRUISER 93210347A100	510418



/ BOUCHON VIDANGE



Désignation	Réf.
BOUCHON VIDANGE MAXI SCOOTER OEM 125 XMAX/MBK SKYCRUISER/MAJESTY (1S7E5351000)	510416



/ BOUCHON VIDANGE, CRÉPINE ET JOINT

Désignation	Réf.
BOUCHON VIDANGE+CRÉPINE+JOINT MAXI SCOOTER TEKNIX ADAPT. CHINOIS M36X150	483637
BOUCHON VIDANGE+CRÉPINE+JOINT SCOOTER/ MAXI SCOOTER TEKNIX ADAPT. CHINOIS GY6/139QMB/152QMI	502694



/ JOINT ETANCHEITE



Désignation	Réf.
JOINT ETANCHEITE CUIVRE (COFFRET PANACHE 400)	484833



518367



518363

/ AGRAFE FIXATION CARROSSERIE

Description	Réf.
(4.5 PARKER) CM017410	518367
(M5) 254485	518363



/ AGRAFE FIXATION CARROSSERIE

Description	Nbre Pièces	Réf.
M5	X10	504526
M6 TYPE OEM PIAGGIO 254485	X1	519358
M6	X10	504527
M8	X10	504528



/ AGRAFES POUR CARROSSERIE

Description	Nbre Pièces	Réf.
COFFRET PANACHE	700	498813



/ VIS OEM PIAGGIO

Description	Réf.
M6X100 LONG 30 MM	518368
M6X100 LONG 35 MM	518371



/ VIS 6 PANS CREUX TC BTR ACIER ZINGUE



Description	Réf.
M5X12 MM	518798
M5X16 MM	518799
M5X20 MM	518800
M5X25 MM	518801
M5X30 MM	518802
M5X35 MM	518803
M5X40 MM	518804
M5X45 MM	518805
M5X50 MM	518806
M6X10 MM	518807
M6X12 MM	518808
M6X20 MM	518809
M6X25 MM	518810
M6X30 MM	518811
M6X35 MM	518812
M6X40 MM	518813
M6X50 MM	518814

Description	Réf.
M6X110 MM	518815
M8X40 MM	518816
M8X70 MM	518817
M8X75 MM	518818
M8X80 MM	518819
M8X90 MM	518820
M10X12 MM	518821
M10X16 MM	518822
M10X20 MM	518823
M10X25 MM	518824
M10X30 MM	518825
M10X35 MM	518826
M10X40 MM	518827
M10X45 MM	518828
M10X50 MM	518829
M10X55 MM	518830
M10X60 MM	518831



/ VIS 6 PANS CREUX TC BTR NOIR



Description	Nbre Pièces	Réf.
M4X20	Sachet X100	509573
M4X25	Sachet X100	509574
M5X20	Boite X100	208448
M5X20	Sachet X100	509562
M5X25	Boite X100	208433
M5X25	Sachet X100	509563
M5X30	Sachet X100	509564
M6X16	Boite X100	162560
M6X16	Sachet X100	509565
M6X20	Boite X100	162574
M6X20	Sachet X100	509566
M6X25	Sachet X100	162589
M6X25	Sachet X100	509567
M6X30	Boite X100	162593
M6X30	Sachet X100	509568
M6X40	Boite X100	162608
M6X40	Sachet X100	509569
M8X20	Sachet X100	509570
M8X30	Sachet X100	509571
M8X40	Sachet X100	509575
M8X60	Sachet X50	509576



/ VIS CARROSSERIE



Description	Réf.
M6X100 LONG 10 MM	518365
M6X100 LONG 16 MM	518369



/ VIS AUTOTARAUEUSE TYPE PARKER



Description	Réf.
Ø 4 - LONG 12 MM	518364
Ø 4 - LONG 12.5 MM	518366
Ø 4 - LONG 20 MM	518373
Ø 4 - LONG 35 MM	518374



/ VIS PARKER TETE RONDE NOIR



Description	Réf.
2,9X9,5 MM ACIER ZINGUE	518763
2,9X13 MM ACIER ZINGUE	518764
2,9X19 MM ACIER ZINGUE	518765
3,5X16 MM ACIER ZINGUE	518766
3,9X9,5 MM ACIER ZINGUE	518770
3,9X13 MM ACIER ZINGUE	518767
3,9X19 MM ACIER ZINGUE	518768
3,9X25 MM ACIER ZINGUE	518769
4,2X9,5 MM ACIER ZINGUE	518775
4,2X13 MM ACIER ZINGUE	518771
4,2X16 MM ACIER ZINGUE	518772
4,2X19 MM ACIER ZINGUE	518773
4,2X32 MM ACIER ZINGUE	518774
5,5X13 MM ACIER ZINGUE	518776
5,5X19 MM ACIER ZINGUE	518777
5,5X32 MM ACIER ZINGUE	518778



/ VIS INOX DE COUVERCLE



Description	Réf.
VIS INOX DE COUVERCLE/CAPOT MAITRE CYLINDRE DE FREIN (4 X12)	483092



/ VIS TETE HEXAGONALE ACIER ZINGUE



Description	Réf.
M6X16 MM	518782
M6X20 MM	518783
M6X25 MM	518784
M6X30 MM	518785
M6X40 MM	518786
M6X50 MM	518787
M6X90 MM	518788
M6X100 MM	518781
M8X10 MM	518789
M8X16 MM	518791
M8X20 MM	518792
M8X30 MM	518793
M8X35 MM	518794
M8X40 MM	518796
M8X50 MM	518797
M8X80 MM	518795
M8X100 MM	518790
M10X25 MM	518780
M10X80 MM	518779



/ VIS BOMBEE 6 PANS CREUX INOX BHC



Description	Réf.	Description	Réf.
M4X6	513030	M5X25	513040
M4X8	513031	M6X10	513041
M4X10	513032	M6X16	513042
M4X12	513033	M6X20	513043
M4X16	513034	M6X25	513044
M5X8	513035	M6X30	513045
M5X10	513036	M6X40	513046
M5X12	513037	M8X20	513047
M5X16	513038	M8X30	513048
M5X20	513039		



/ VIS TOLE ZINGUE TETE BOMBE CRUCIFORME ET FENDUE

Description	Nbre Pièces	Réf.
Tête cruciforme 2.8X12 Qté : 300 - 3.5X12 Qté : 100 3.5X18 Qté : 100 - 4.1X12 Qté : 100 4.1X18 Qté : 100 - 4.7X12 Qté : 100 4.7X18 Qté : 50 - 5.4X19 Qté : 50 Tête fendue 2.8X12 Qté : 300 - 3.5X12 Qté : 100 3.5X18 Qté : 100 - 4.1X12 Qté : 100 4.2X18 Qté : 100 - 4.7X12 Qté : 100 4.7X18 Qté : 50 - 5.3X18 Qté : 50	X1800	504937



/ VIS CARROSSERIE

Description	Nbre Pièces	Réf.
VIS CARROSSERIE (6X1/2 - 8X1/2 - 10X1/2 - 6X3/4 - 8X3/4 - 10X3/4)	Coffret 420	498798
VIS CARROSSERIE (6X1/2 - 8X1/2 - 10X1/2 - 6X3/4 - 8X3/4 - 10X3/4)	Coffret 700	498814



506033



520527

/ VIS FIXATION DISQUE FREIN

Description	Nbre Pièces	Réf.
VIS FIXATION COURONNE/DISQUE FREIN M8X125-30 (COMPRED 6 VIS TETE FRAISE/6 RONDELLES/ 6 E		506033
VIS FIXATION DISQUE FREIN M8X20 PAS 125	X6	520527



/ VIS ET AGRAFE POUR CARROSSERIE

Description	Nbre Pièces	Réf.
11X16X4.5X0.6	Livrée X20	478430
12.5X20X4.5X0.6	Livrée X20	478431



/ VIS QUART DE TOUR CARROSSERIE TYPEE DZUS

Description	Nbre Pièces	Réf.
NOIR Ø 6	Kit de 10	494527



/ RONDELLE PLATE ACIER

Description	Nbre Pièces	Réf.
4X10	Boite X100	8814
4X16	Boite X100	263473
7X14	Boite X100	8819



/ RONDELLE PLATE ACIER

Description	Nbre Pièces	Réf.
5X10X1	Boite X200	509532
5X13	Boite X50	8817
5X19	Boite X50	8823
5.4X19X1.4	Boite X120	517958
6X12X1.5	Boite X200	509531
6X13	Boite X50	8818
6X19	Boite X50	263488
8X16X1.5	Boite X200	509530
10X20	Boite X50	8821
10X20X1.9	Boite X100	509529



**/ COFFRET
RONDELLE PLATE - ACIER**



Description	Nbre Pièces	Réf.
PANACHE M5/M6/M8/M10	Boite XI550	509554



504631 483800 517234 504632 504630



**/ RIVET/CLIPS PLASTIQUE - NOIR
POUR CARENAGE/CARROSSERIE**

Description	Réf.
Ø 5.5	504631
Ø 5.8	483800
Ø 6	517234
Ø 7.5	504632
Ø 8	504630



/ ECROU HEXAGONAL

Description	Nbre Pièces	Réf.
M4	Boite X100	8933
M5	Boite X100	8934
M5/16X26 BSC	Boite X100	8844
M6	Boite X100	8935
M8X125	Boite X50	263454



/ ECROU 6 PANS NYLSTOP/FREIN ZINC

Description	Nbre Pièces	Réf.
M10	X50	509550
M12	X30	509552
M4	X100	509526
M5	X100	509527
M6	X100	509528



525668 525669 525670 525671



/ ECROU 6 PANS ZINC

Description	Nbre Pièces	Réf.
M4	x1	525668
M5	x1	525669
M6	x1	525670
M7	x1	525671
M8	x1	525672
M10	x1	525673



525672 525673



/ ECROU 6 PANS NYLSTOP/FREIN ZINC

Description	Nbre Pièces	Réf.
M3/M4/M5/M6/M8/M10/M12	Coffret 320	504935



/ ECROU 6 PANS EPAULE ZINGUE

Description	Nbre Pièces	Réf.
M6X1.00 MM/M8X1.25 MM/M10X1.5 MM	Coffret 310	504938



/ BANDE PLAQUE IMMATRICULATION NR BLANCHE 210X145-130 SIV (X10)

Désignation	Réf.	Désignation	Réf.	Désignation	Réf.
DEPT 01 - AIN	496501	DEPT 45 - LOIRET	496545	DEPT 88 - VOSGES	496588
DEPT 02 - AISNE	496502	DEPT 46 - LOT	496546	DEPT 89 - YONNE	496589
DEPT 03 - ALLIER	496503	DEPT 47 - LOT ET GARONNE	496547	DEPT 90 - TERRITOIRE DE BELFORT	496590
DEPT 04 - ALPES HAUTES PROVENÇE	496504	DEPT 48 - LOZERE	496548	DEPT 91 - ESSONNE	496591
DEPT 05 - HAUTES ALPES	496505	DEPT 49 - MAINE ET LOIRE	496549	DEPT 92 - HAUTS DE SEINE	496592
DEPT 06 - ALPES MARITIMES	496506	DEPT 50 - MANCHE	496550	DEPT 93 - SEINE SAINT DENIS	496593
DEPT 07 - ARDECHE	496507	DEPT 51 - MARNE	496551	DEPT 94 - VAL DE MARNE	496594
DEPT 08 - ARDENNES	496508	DEPT 52 - HAUTE MARNE	496552	DEPT 95 - VAL D'OISE	496595
DEPT 09 - ARIEGES	496509	DEPT 53 - MAYENNE	496553	DEPT 2A - CORSE DU SUD	496601
DEPT 10 - AUBE	496510	DEPT 54 - MEURTHE ET MOSELLE	496554	DEPT 2B - HAUTE CORSE	496602
DEPT 11 - AUDE	496511	DEPT 55 - MEUSE	496555	DEPT 971 - GUADELOUPE	496596
DEPT 12 - AVEYRON	496512	DEPT 56 - MORBIHAN	496556	DEPT 972 - MARTINIQUE	496597
DEPT 13 - BOUCHES DU RHONE	496513	DEPT 57 - MOSELLE	496557	DEPT 973 - GUYANE	496598
DEPT 14 - CALVADOS	496514	DEPT 58 - NIEVRE	496558	DEPT 974 - LA REUNION	496599
DEPT 15 - CANTAL	496515	DEPT 59 - NORD	496559	DEPT 976 - MAYOTTE	496600
DEPT 16 - CHARENTE	496516	DEPT 60 - OISE	496560		
DEPT 17 - CHARENTE MARITIME	496517	DEPT 61 - ORNE	496561		
DEPT 18 - CHER	496518	DEPT 62 - PAS DE CALAIS	496562		
DEPT 19 - CORREZE	496519	DEPT 63 - PUY DE DOME	496563		
DEPT 21 - COTE D'OR	496521	DEPT 64 - PYRENEES ATLANTIQUES	496564		
DEPT 22 - COTES D'ARMOR	496522	DEPT 65 - HAUTES PYRENEES	496565		
DEPT 23 - CREUSE	496523	DEPT 66 - PYRENEES ORIENTALES	496566		
DEPT 24 - DORDOGNE	496524	DEPT 67 - BAS RHIN	496567		
DEPT 25 - DOUBS	496525	DEPT 68 - HAUT RHIN	496568		
DEPT 26 - DROME	496526	DEPT 69 - RHONE	496569		
DEPT 27 - EURE	496527	DEPT 70 - HAUTE SAONE	496570		
DEPT 28 - EURE ET LOIRE	496528	DEPT 71 - SAONE ET LOIRE	496571		
DEPT 29 - FINISTERE	496529	DEPT 72 - SARTHE	496572		
DEPT 30 - GARD	496530	DEPT 73 - SAVOIE	496573		
DEPT 31 - HAUTE GARONNE	496531	DEPT 74 - HAUTE SAVOIE	496574		
DEPT 32 - GERS	496532	DEPT 75 - PARIS	496575		
DEPT 33 - GIRONDE	496533	DEPT 76 - SEINE MARITIME	496576		
DEPT 34 - HERAULT	496534	DEPT 77 - SEINE ET MARNE	496577		
DEPT 35 - ILE ET VILAINE	496535	DEPT 78 - YVELINES	496578		
DEPT 36 - INDRE	496536	DEPT 79 - DEUX SEVRES	496579		
DEPT 37 - INDRE ET LOIRE	496537	DEPT 80 - SOMME	496580		
DEPT 38 - ISERE	496538	DEPT 81 - TARN	496581		
DEPT 39 - JURA	496539	DEPT 82 - TARN ET GARONNE	496582		
DEPT 40 - LANDES	496540	DEPT 83 - VAR	496583		
DEPT 41 - LOIR ET CHER	496541	DEPT 84 - VAUCLUSE	496584		
DEPT 42 - LOIRE	496542	DEPT 85 - VENDEE	496585		
DEPT 43 - HAUTE LOIRE	496543	DEPT 86 - VIENNE	496586		
DEPT 44 - LOIRE ATLANTIQUE	496544	DEPT 87 - HAUTE VIENNE	496587		

Exemples de plaque

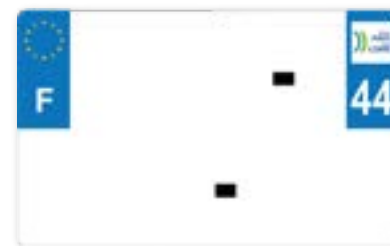

496544



**/ PLAQUE IMMATRICULATION NR 210X145
MOTO/SCOOTER/CYCLO - PLEXI (X10)**

Réf. 496496

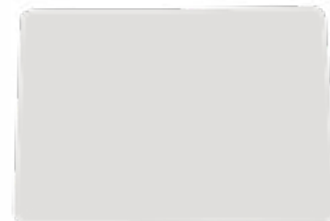

**/ PLAQUE IMMATRICULATION NR
210X130 MOTO - PLEXI (X10)**

210X130 MOTO/SCOOTER/CYCLO

Réf. 496495



**/ BANDE PLAQUE IMMATRICULATION NR 210X145
(X10) - RETRO NOIR (COLLECTION)**

Réf. 505199



**/ BANDE PLAQUE IMMATRICULATION NR 210X145-130
(X10) - EUROLOGO - POUR 50 CC ET ANCIENNE IMMAT**

Réf. 496497



/ IMPRIMANTE PLAQUE IMMATRICULATION LASER

SOUS CONTRAT DE PRET

Réf. 501145



**/ IMPRIMANTE PLAQUE IMMATRICULATION
THERMIQUE**

SOUS CONTRAT DE PRET

Réf. 496603



/ ROULEAU BANDE THERMIQUE

Désignation	Réf.
PLAQUE IMMATRICULATION SPM - 300 M (GRIS POUR BANDE RETRO NOIR)	505335
IMPRIMANTE PLAQUE IMMATRICULATION SPM - 300 M (SOIT ENVIRON 490 PLAQUES)	496869



505335

TIFLEX
/ PLAQUE IMMATRICULATION PREPERCEE BLANCHE 210X130 SIV X10

Désignation	Réf.	Désignation	Réf.	Désignation	Réf.
DEPT 01 - AIN	491501	DEPT 47 - LOT ET GARONNE	491547	DEPT 92 - HAUTE SEINE	491592
DEPT 02 - AISNE	491502	DEPT 48 - LOZERE	491548	DEPT 93 - SEINE SAINT DENIS	491593
DEPT 03 - ALLIER	491503	DEPT 49 - MAINE ET LOIRE	491549	DEPT 94 - VAL DE MARNE	491594
DEPT 04 - ALPES HAUTES PROVENÇE	491504	DEPT 50 - MANCHE	491550	DEPT 95 - VAL D'OISE	491595
DEPT 05 - HAUTES ALPES	491505	DEPT 51 - MARNE	491551	DEPT 2A - CORSE DU SUD	491601
DEPT 06 - ALPES MARITIMES	491506	DEPT 52 - HAUTE MARNE	491552	DEPT 2B - HAUTE CORSE	491602
DEPT 07 - ARDECHE	491507	DEPT 53 - MAYENNE	491553	DEPT 971 - GUADELOUPE	491596
DEPT 08 - ARDENNES	491508	DEPT 54 - MEURTHE ET MOSELLE	491554	DEPT 972 - MARTINIQUE	491597
DEPT 09 - ARIEGES	491509	DEPT 55 - MEUSE	491555	DEPT 973 - GUYANE	491598
DEPT 10 - AUBE	491510	DEPT 56 - MORBIHAN	491556	DEPT 974 - LA REUNION	491599
DEPT 11 - AUDE	491511	DEPT 57 - MOSELLE	491557	DEPT 976 - MAYOTTE	491600
DEPT 12 - AVEYRON	491512	DEPT 58 - NIEVRE	491558		
DEPT 13 - BOUCHES DU RHONE	491513	DEPT 59 - NORD	491559		
DEPT 14 - CALVADOS	491514	DEPT 60 - OISE	491560		
DEPT 15 - CANTAL	491515	DEPT 61 - ORNE	491561		
DEPT 16 - CHARENTE	491516	DEPT 62 - PAS DE CALAIS	491562		
DEPT 17 - CHARENTE MARITIME	491517	DEPT 63 - PUY DE DOME	491563		
DEPT 18 - CHER	491518	DEPT 64 - PYRENEES ATLANTIQUES	491564		
DEPT 19 - CORREZE	491519	DEPT 65 - HAUTES PYRENEES	491565		
DEPT 21 - COTE D'OR	491521	DEPT 66 - PYRENEES ORIENTALES	491566		
DEPT 22 - COTES D'ARMOR	491522	DEPT 67 - BAS RHIN	491567		
DEPT 23 - CREUSE	491523	DEPT 68 - HAUT RHIN	491568		
DEPT 24 - DORDOGNE	491524	DEPT 69 - RHONE	491569		
DEPT 25 - DOUBS	491525	DEPT 70 - HAUTE SAONE	491570		
DEPT 26 - DROME	491526	DEPT 71 - SAONE ET LOIRE	491571		
DEPT 27 - EURE	491527	DEPT 72 - SARTHE	491572		
DEPT 28 - EURE ET LOIR	491528	DEPT 73 - SAVOIE	491573		
DEPT 29 - FINISTERE	491529	DEPT 74 - HAUTE SAVOIE	491574		
DEPT 30 - GARD	491530	DEPT 75 - PARIS	491575		
DEPT 31 - HAUTE GARONNE	491531	DEPT 76 - SEINE MARITIME	491576		
DEPT 32 - GERS	491532	DEPT 77 - SEINE ET MARNE	491577		
DEPT 33 - GIRONDE	491533	DEPT 78 - YVELINES	491578		
DEPT 34 - HERAULT	491534	DEPT 79 - DEUX SEVRES	491579		
DEPT 35 - ILE ET VILAINE	491535	DEPT 80 - SOMME	491580		
DEPT 36 - INDRE	491536	DEPT 81 - TARN	491581		
DEPT 37 - INDRE ET LOIRE	491537	DEPT 82 - TARN ET GARONNE	491582		
DEPT 38 - ISERE	491538	DEPT 83 - VAR	491583		
DEPT 39 - JURA	491539	DEPT 84 - VAUCLUSE	491584		
DEPT 40 - LANDES	491540	DEPT 85 - VENDEE	491585		
DEPT 41 - LOIR ET CHER	491541	DEPT 86 - VIENNE	491586		
DEPT 42 - LOIRE	491542	DEPT 87 - HAUTE VIENNE	491587		
DEPT 43 - HAUTE LOIRE	491543	DEPT 88 - VOSGES	491588		
DEPT 44 - LOIRE ATLANTIQUE	491544	DEPT 89 - YONNE	491589		
DEPT 45 - LOIRET	491545	DEPT 90 - TERRITOIRE DE BELFORT	491590		
DEPT 46 - LOT	491546	DEPT 91 - ESSONNE	491591		

Exemple de plaque



491501

TIFLEX
/ PLAQUE IMMATRICULATION PREPERCEE BLANCHE SIV 210X140 (X50)

Réf. 468820



/ PLAQUE IMMATRICULATION PLEXI BLANCHE 210X140 SIV REALISE (X1)

Désignation	Réf.	Désignation	Réf.	Désignation	Réf.
DEPT 01 - AIN	513662	DEPT 44 - LOIREATLANTIQUE	513704	DEPT 86 - VIENNE(XI)	513746
DEPT 02 - AISNE(XI)	513663	DEPT 45 - LOIRET(XI)	513705	DEPT 87 - HAUTEVIENNE	513747
DEPT 03 - ALLIER	513664	DEPT 46 - LOT	513706	DEPT 88 - VOSGES(XI)	513748
DEPT 04 - ALPESH. PRO.	513665	DEPT 47 - LOT ETGARONNE	513707	DEPT 89 - YONNE(XI)	513749
DEPT 05 - HAUTES ALPES	513666	DEPT 48 - LOZERE(XI)	513708	DEPT 90 - TER. DE BELFORT(XI)	513750
DEPT 06 - ALPESMARITIMES(XI)	513667	DEPT 49 - MAINEET LOIRE	513709	DEPT 91 - ESSONE(XI)	513751
DEPT 07 - ARDECHE	513668	DEPT 50 - MANCHE(XI)	513710	DEPT 92 - HAUTESEINE	513752
DEPT 08 - ARDENNES	513669	DEPT 51 - MARNE(XI)	513711	DEPT 93 - SEINEST DENIS	513753
DEPT 09 - ARIEGES	513670	DEPT 52 - HAUTEMARNE	513712	DEPT 94 - VAL DEMARNE	513754
DEPT 10 - AUBE(XI)	513671	DEPT 53 - MAYENNE	513713	DEPT 95 - VAL D'OISE	513755
DEPT 11 - AUDE(XI)	513672	DEPT 54 - MEURTHE ET MO.	513714	DEPT 2A - CORSEDU SUD	513756
DEPT 12 - AVEYRON	513673	DEPT 55 - MEUSE(XI)	513715	DEPT 2B - HAUTECORSE	513757
DEPT 13 - BOUCHES/RHONE	513674	DEPT 56 - MORBIHAN	513716	DEPT 971 - GUADELOUPE	514046
DEPT 14 - CALVADOS	513675	DEPT 57 - MOSELLE	513717	DEPT 972 - MARTINIQUE	514047
DEPT 15 - CANTAL	513676	DEPT 58 - NIEVRE(XI)	513718	DEPT 973 - GUYANE	514048
DEPT 16 - CHARENTE	513677	DEPT 59 - NORD	513719	DEPT 974 - LA REUNION	514049
DEPT 17 - CHARENTE MAR.	513678	DEPT 60 - OISE	513720	DEPT 976 - MAYOTTE	514050
DEPT 18 - CHER	513679	DEPT 61 - ORNE	513721		
DEPT 19 - CORREZE	513680	DEPT 62 - PAS DECALAIS	513722		
DEPT 21 - COTE D'OR	513681	DEPT 63 - PUY DEDOME	513723		
DEPT 22 - COTESD'ARMOR	513682	DEPT 64 - PYRENEES ATL.	513724		
DEPT 23 - CREUSE(XI)	513683	DEPT 65 - HAUTESPYRENEES	513725		
DEPT 24 - DORDOGNE	513684	DEPT 66 - PYRENEES ORIEN.	513726		
DEPT 25 - DOUBS(XI)	513685	DEPT 67 - BAS RHIN	513727		
DEPT 26 - DROME(XI)	513686	DEPT 68 - HAUT RHIN	513728		
DEPT 27 - EURE	513687	DEPT 69 - RHONE(XI)	513729		
DEPT 28 - EURE ET LOIR	513688	DEPT 70 - HAUTESAONE	513730		
DEPT 29 - FINISTERE	513689	DEPT 71 - SAONEET LOIRE	513731		
DEPT 30 - GARD	513690	DEPT 72 - SARTHE(XI)	513732		
DEPT 31 - HAUTEGARONNE	513691	DEPT 73 - SAVOIE(XI)	513733		
DEPT 32 - GERS	513692	DEPT 74 - HAUTESAVOIE	513734		
DEPT 33 - GIRONDE	513693	DEPT 75 - PARIS(XI)	513735		
DEPT 34 - HERAULT	513694	DEPT 76 - SEINEMARITIME	513736		
DEPT 35 - ILE ETVILAINE	513695	DEPT 77 - SEINEET MARNE	513737		
DEPT 36 - INDRE(XI)	513696	DEPT 78 - YVELINES	513738		
DEPT 37 - INDREET LOIRE	513697	DEPT 79 - DEUX SEVRES	513739		
DEPT 38 - ISERE(XI)	513698	DEPT 80 - SOMME(XI)	513740		
DEPT 39 - JURA	513699	DEPT 81 - TARN(XI)	513741		
DEPT 40 - LANDES(XI)	513700	DEPT 82 - TARN ET GAR.	513742		
DEPT 41 - LOIR ET CHER	513701	DEPT 83 - VAR	513743		
DEPT 42 - LOIRE(XI)	513702	DEPT 84 - VAUCLUSE	513744		
DEPT 43 - HAUTLOIRE	513703	DEPT 85 - VENDEE(XI)	513745		

Exemple de plaque



513662

**PLAQUE RÉALISÉE
SUR DEMANDE,
AR NOS SOINS**

/ BANDE PLAQUE IMMATRICULATION NR BLANCHE 520X110 AUTO (X10)

Désignation	Réf.	Désignation	Réf.	Désignation	Réf.
DEPT 01	496938	DEPT 45	496981	DEPT 88 - SUR COMMANDE	497024
DEPT 02	496939	DEPT 46 - SUR COMMANDE	496982	DEPT 89 - SUR COMMANDE	497025
DEPT 03 - SUR COMMANDE	496940	DEPT 47	496983	DEPT 90 - SUR COMMANDE	497026
DEPT 04	496941	DEPT 48 - SUR COMMANDE	496984	DEPT 91	497027
DEPT 05 - SUR COMMANDE	496942	DEPT 49	496985	DEPT 92	497028
DEPT 06	496943	DEPT 50	496986	DEPT 93 - SUR COMMANDE	497029
DEPT 07	496944	DEPT 51 - SUR COMMANDE	496987	DEPT 94 - SUR COMMANDE	497030
DEPT 08	496945	DEPT 52 - SUR COMMANDE	496988	DEPT 95 - SUR COMMANDE	497031
DEPT 09	496946	DEPT 53	496989	DEPT 2A - SUR COMMANDE	497041
DEPT 10	496947	DEPT 54	496990	DEPT 2B	497042
DEPT 11 - SUR COMMANDE	496948	DEPT 55 - SUR COMMANDE	496991	DEPT 97I	497032
DEPT 12 - SUR COMMANDE	496949	DEPT 56	496992	DEPT 972 - SUR COMMANDE	497033
DEPT 13 - SUR COMMANDE	496950	DEPT 57	496993	DEPT 973 - SUR COMMANDE	497034
DEPT 14	496951	DEPT 58 - SUR COMMANDE	496994	DEPT 974 - SUR COMMANDE	497035
DEPT 15	496952	DEPT 59	496995	DEPT 976	497036
DEPT 16 - SUR COMMANDE	496953	DEPT 60 - SUR COMMANDE	496996	EUROLOGO	496872
DEPT 17	496954	DEPT 61	496997		
DEPT 18	496955	DEPT 62	496998		
DEPT 19 - SUR COMMANDE	496956	DEPT 63 - SUR COMMANDE	496999		
DEPT 21 - SUR COMMANDE	496957	DEPT 64 - SUR COMMANDE	497000		
DEPT 22	496958	DEPT 65 - SUR COMMANDE	497001		
DEPT 23	496959	DEPT 66	497002		
DEPT 24 - SUR COMMANDE	496960	DEPT 67 - SUR COMMANDE	497003		
DEPT 25	496961	DEPT 68 - SUR COMMANDE	497004		
DEPT 26	496962	DEPT 69 - SUR COMMANDE	497005		
DEPT 27	496963	DEPT 70 - SUR COMMANDE	497006		
DEPT 28	496964	DEPT 71	497007		
DEPT 29	496965	DEPT 72 - SUR COMMANDE	497008		
DEPT 30	496966	DEPT 73	497009		
DEPT 31	496967	DEPT 74	497010		
DEPT 32 - SUR COMMANDE	496968	DEPT 75 - SUR COMMANDE	497011		
DEPT 33	496969	DEPT 76	497012		
DEPT 34	496970	DEPT 77	497013		
DEPT 35	496971	DEPT 78	497014		
DEPT 36	496972	DEPT 79	497015		
DEPT 37	496973	DEPT 80	497016		
DEPT 38 - SUR COMMANDE	496974	DEPT 81	497017		
DEPT 39 - SUR COMMANDE	496975	DEPT 82 - SUR COMMANDE	497018		
DEPT 40 - SUR COMMANDE	496976	DEPT 83	497019		
DEPT 41 - SUR COMMANDE	496977	DEPT 84	497020		
DEPT 42 - SUR COMMANDE	496978	DEPT 85 - SUR COMMANDE	497021		
DEPT 43	496979	DEPT 86 - SUR COMMANDE	497022		
DEPT 44	496980	DEPT 87 - SUR COMMANDE	497023		

Exemple de plaque

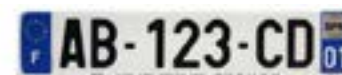

496938

/ PLAQUE IMMATRICULATION NR 520X110 AUTO - PLEXI (X10)

 PLAQUE IMMATRICULATION NR SPM
 520X110 AUTO - PLEXI (X10)

Réf. 496873



/ PLAQUE IMMATRICULATION PLEXI PMMA BLANCHE AUTO 520X110 SIV REALISE (X1)

Désignation	Réf.	Désignation	Réf.	Désignation	Réf.
DEPT 01 - AIN	513759	DEPT 44 - LOIRE ATLANTIQUE (X1)	513801	DEPT 86 - VIENNE	513843
DEPT 02 - AISNE	513760	DEPT 45 - LOIRET	513802	DEPT 87 - HAUTE VIENNE	513844
DEPT 03 - ALLIER	513761	DEPT 46 - LOT	513803	DEPT 88 - VOSGES	513845
DEPT 04 - ALPES H. PRO.	513762	DEPT 47 - LOT ET GARONNE	513804	DEPT 89 - YONNE	513846
DEPT 05 - HAUTES ALPES	513763	DEPT 48 - LOZERE	513805	DEPT 90 - TER. DE BELFORT	513847
DEPT 06 - ALPES MARITIMES	513764	DEPT 49 - MAINE ET LOIRE	513806	DEPT 91 - ESSONE	513848
DEPT 07 - ARDECHE	513765	DEPT 50 - MANCHE	513807	DEPT 92 - HAUTE SEINE	513849
DEPT 08 - ARDENNES	513766	DEPT 51 - MARNE	513808	DEPT 93 - SEINE ST DENIS	513850
DEPT 09 - ARIEGES	513767	DEPT 52 - HAUTE MARNE	513809	DEPT 94 - VAL DE MARNE	513851
DEPT 10 - AUBE	513768	DEPT 53 - MAYENNE	513810	DEPT 95 - VAL D'OISE	513852
DEPT 11 - AUDE	513769	DEPT 54 - MEURTHE ET MO.	513811	DEPT 2A - CORSE DU SUD	513853
DEPT 12 - AVEYRON	513770	DEPT 55 - MEUSE	513812	DEPT 2B - HAUTE CORSE	513854
DEPT 13 - BOUCHES/RHONE	513771	DEPT 56 - MORBIHAN	513813	DEPT 971 - GUADELOUPE	514051
DEPT 14 - CALVADOS	513772	DEPT 57 - MOSELLE	513814	DEPT 972 - MARTINIQUE	514052
DEPT 15 - CANTAL	513773	DEPT 58 - NIEVRE	513815	DEPT 973 - GUYANE	514053
DEPT 16 - CHARENTE	513774	DEPT 59 - NORD	513816	DEPT 974 - LA REUNION	514054
DEPT 17 - CHARENTE MAR.	513775	DEPT 60 - OISE	513817	DEPT 976 - MAYOTTE	514055
DEPT 18 - CHER	513776	DEPT 61 - ORNE	513818		
DEPT 19 - CORREZE	513777	DEPT 62 - PAS DE CALAIS	513819		
DEPT 21 - COTE D'OR	513778	DEPT 63 - PUY DE DOME	513820		
DEPT 22 - COTES D'ARMOR	513779	DEPT 64 - PYRENEES ATL.	513821		
DEPT 23 - CREUSE	513780	DEPT 65 - HAUTES PYRENEES	513822		
DEPT 24 - DORDOGNE	513781	DEPT 66 - PYRENEES ORIEN.	513823		
DEPT 25 - DOUBS	513782	DEPT 67 - BAS RHIN	513824		
DEPT 26 - DROME	513783	DEPT 68 - HAUT RHIN	513825		
DEPT 27 - EURE	513784	DEPT 69 - RHONE	513826		
DEPT 28 - EURE ET LOIR	513785	DEPT 70 - HAUTE SAONE	513827		
DEPT 29 - FINISTERE	513786	DEPT 71 - SAONE ET LOIRE	513828		
DEPT 30 - GARD	513787	DEPT 72 - SARTHE	513829		
DEPT 31 - HAUTE GARONNE	513788	DEPT 73 - SAVOIE	513830		
DEPT 32 - GERS	513789	DEPT 74 - HAUTE SAVOIE	513831		
DEPT 33 - GIRONDE	513790	DEPT 75 - PARIS	513832		
DEPT 34 - HERAULT	513791	DEPT 76 - SEINE MARITIME	513833		
DEPT 35 - ILE ET VILAINE	513792	DEPT 77 - SEINE ET MARNE	513834		
DEPT 36 - INDRE	513793	DEPT 78 - YVELINES	513835		
DEPT 37 - INDRE ET LOIRE	513794	DEPT 79 - DEUX SEVRES	513836		
DEPT 38 - ISERE	513795	DEPT 80 - SOMME	513837		
DEPT 39 - JURA	513796	DEPT 81 - TARN	513838		
DEPT 40 - LANDES	513797	DEPT 82 - TARN ET GAR.	513839		
DEPT 41 - LOIR ET CHER	513798	DEPT 83 - VAR	513840		
DEPT 42 - LOIRE	513799	DEPT 84 - VAUCLUSE	513841		
DEPT 43 - HAUTE LOIRE	513800	DEPT 85 - VENDEE	513842		

Exemple de plaque



513759



497039



497038

/ BANDE PLAQUE IMMATRICULATION NR 100X100 MOTO - BLANCHE

Désignation	Réf.
SPECIAL ENDURO -TRAPEZE NON HOMOLOGUE	497039
SPECIAL ENDURO - NON HOMOLOGUE (X10)	497037

/ PLAQUE IMMATRICULATION NR 100X100 MOTO - PLEXI (X10)

Désignation	Réf.
SPECIAL ENDURO -TRAPEZE NON HOMOLOGUE	497040
SPECIAL ENDURO - NON HOMOLOGUE	497038

TIFLEX

/ LETTRE POUR PLAQUE PREPERCEE 45MM X10

Désignation	Réf.	Désignation	Réf.	Désignation	Réf.
A	450907	J	450916	S	450926
B	450908	K	450917	T	450927
C	450909	L	450918	U	450928
D	450910	M	450919	V	450929
E	450911	N	450920	W	450930
F	450912	P	450923	X	450931
G	450913	Q	450924	Y	450932
H	450914	R	450925	Z	450933



TIFLEX

/ LETTRE POUR PLAQUE PREPERCEE 45MM X10

Désignation	Réf.	Désignation	Réf.
0	451599	6	450948
1	450943	7	450949
2	450944	8	450950
3	450945	9	450951
4	450946		
5	450947		

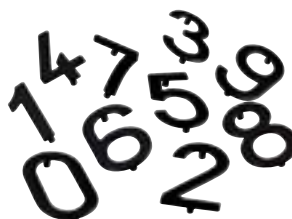

TIFLEX

/ PLOMB

PLOMB PLAQUE IMMATRICULATION TIFLEX (SACHET)
Réf. 455353



/ RIVET PLAQUE IMMATRICULATION

RIVET PLAQUE IMMATRICULATION BLANC 4X16 (X100)
Réf. 455310



CONCEPT NR[®]

Contactez nous :

☎ 04 74 42 27 02

✉ contact@spm-groupe.com



NR2 . MOTO & CYCLO

- Plaque haut de gamme.
- Impression thermique ou laser.
- Formats autos et carrés disponibles
- Formats motos disponibles :
 - 210 x 130 mm ou
 - 210 x 145 mm avec RS



MOTEUR

CYCLE

PNEUMATIQUE

ATELIER

ACCESSOIRES

ÉLECTRICITÉ

FILTRATION

FREINAGE

TRANSMISSION

/ ACCESSOIRES / ACCESORIES	502
/ EQUIPEMENTS VEHICULES / VEHICLES EQUIPMENTS	504
/ LUNETTES / GLASSES	520
/ TOP CASES / TOP CASES	523





/ ANNEAU ANCRAGE

Description	Réf.
ANNEAU ANCRAGE ANTIVOL RANGERS (D.14MM)	508912



/ ANTIVOL VELO/SCOOTER/MOTO CABLE MAGASIN

Description	Réf.
LONGUEUR 5M DIAMETRE 10	494352
AXA DOUBLE LOOP 1000 LONGUEUR 10M DIAMETRE 10	527865



494352

527865



517933

516845

516846

517838

517934

517839

517935



/ ANTIVOL U

Description	Réf.
48X75 CLASSE SRA FABRICATION EUROPE - BLACK EDITION - LIVRE AVEC 6 CLES	517933
85X125 CLASSE SRA FABRICATION EUROPE - BLACK EDITION - LIVRE AVEC 6 CLES	516845
85X250 CLASSE SRA FABRICATION EUROPE - BLACK EDITION - LIVRE AVEC 6 CLES	516846
48X75 CLASSE SRA FABRICATION EUROPE - BLACK EDITION	517838
85X125 CLASSE SRA FABRICATION EUROPE - BLACK EDITION	517934
85X250 CLASSE SRA FABRICATION EUROPE - BLACK EDITION	517839
120X220 CLASSE SRA FABRICATION EUROPE - BLACK EDITION	517935



/ ANTIVOL U

Description	Réf.
120X125 CLASSE SRA FABRICATION EUROPE	498806



/ ANTIVOL U

Description	Réf.
46X69 CLASSE SRA FABRICATION EUROPE	486955





/ ANTIVOL BLOQUE DISQUE



526725



526726

Description	Réf.
MAX10 + ALARME (D.10MM) CLASSE SRA MADE IN EUROPE	526725
MAX15 + ALARME (D.14MM) CLASSE SRA MADE IN EUROPE	526726



/ ANTIVOL BLOQUE DISQUE + ALARME

Description	Réf.
D.6MM MADE IN CEE	486957



/ ANTIVOL U

Description	Réf.
46X69 + CHAINE SRA 1.00M DIAM.14.5MM CLASSE SRA EUROPE	480339



/ ANTIVOL U

Description	Réf.
46X69 + CHAINE LASSO 1.20M CLASSE SRA FABRICATION EUROPE	486954



/ ANTIVOL CHAINE

Description	Réf.
SEUL TYPE LASSO 1.20M POUR U DIAMETRE ANSE 20MM MAXI MADE IN CEE	487311



ACCESSOIRES & ÉQUIPEMENTS VEHICULE / ACCESORIES & VEHICLES EQUIPMENTS

CGN
LE SENS DU DÉTAIL

MOTEUR

CYCLE

PNEUMATIQUE

ATELIER

ACCESSOIRES

ÉLECTRICITÉ

FILTRATION

FREINAGE

TRANSMISSION



/ CEINTURE LOMBAIRE



Description	Réf.
CINTUKAWARM CHAUFFANT	509020



/ COUSSIN CHAUFFANT



Description	Réf.
TERMOWARM POUR TABLIER TERMOSCUD	509021



/ COUVRE SELLE CHAUFFANT



Description	Réf.
COOLWARM	509022



/ MANCHON/PROTECTION SELECTEUR



Description	Réf.
NEW FOOT ON - SILICONE	508033



/ SAC ETANCHE CASQUE



Description	Réf.
PROTECTION CASQUE - 488	508030



/ MANCHON/PROTECTION SELECTEUR



Description	Réf.
LAFASCETTA	508034



/ COUVRE SELLE ETANCHE

Description	Réf.
POUR SELLE MAXI SCOOTER/MOTO 130X80 CM	508003
POUR SELLE SCOOTER 60X95 CM	508001
POUR SELLE SCOOTER/MAXI SCOOTER 100X55 CM	518134



508003



508001 > 518134



/ HOUSSE/BACHE DE PROTECTION ETANCHE START NOIR

Description	Réf.
TAILLE L 219X127X90CM	509029
TAILLE M 204X163X92CM	509028
TAILLE S 186X124X86CM	509027



/ REVETEMENT POIGNEE CHAUFFANTE



Description	Réf.
A CLIPSER(PR)	508685

DS COVERS

HOUSSE DE MOTO/SCOOTER DELTA

HOUSSE DE MOTO/SCOOTER assurant une protection solide en extérieur.



Désignations	Tailles	Couleurs	Réf.
DELTA	M	■	527993
DELTA	L	■	527994
DELTA	XL	■	527995
DELTA	XXL	■	527996



Protection extérieure
contre pluie, saleté, gel et UV



Ourllet élastique pour
un ajustement douillet



Coutures doubles
avec du ruban anti-eau



Ouvertures antivol renforcées



Sangle réglable maintient
housses en place



Volets de ventilation pour
réduire la condensation



Matière: **polyester 300D**
(100% imperméable)



Livré dans un **sac de rangement pratique**



Disponible dans les tailles
suivantes:
Coupe régulière: M | L | XL | XXL

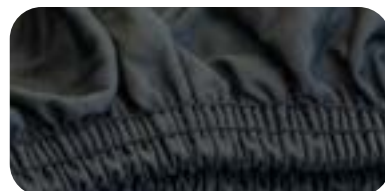

DS COVERS

HOUSSE DE MOTO/SCOOTER ALFA

HOUSSE DE MOTO/SCOOTER de luxe qui protège des agressions climatiques extrêmes. Disponible pour plusieurs types de motos.



Disponibles dans les tailles suivantes :
Coupe régulière : M | L | XL | XXL



Désignations	Tailles	Couleurs	Réf.
ALFA	M	■	527981
ALFA	L	■	527982
ALFA	XL	■	527983
ALFA	XXL	■	527984



Protection extérieure
contre pluie, saleté, gel et UV



Panneaux résistants à la chaleur en position d'échappement (jusqu'à 300°C)



En option: **fenêtre de la plaque d'immatriculation**



Ourlet élastique pour un ajustement douillet



Coutures doubles



Ouvertures antivol renforcées



DS COVERS

HOUSSE DE MOTO/SCOOTER ALFA TOPCASE

Coupe Topcase



↔ Disponible dans les tailles suivantes :
Coupe régulière : L | XL | XXL
*Voir le tableau des dimensions page 9.

DS COVERS

HOUSSE DE MOTO/SCOOTER ALFA 3W

Coupe 3W : extra large à l'avant (pour Piaggio MP3, Gilera Fuoco, Peugeot Metropolis)



↔ Disponible dans les tailles suivantes :
Coupe 3W : sans topcase | avec topcase
*Voir le tableau des dimensions page 9.

Désignations	Tailles	Couleurs	Réf.
ALFA TOPCASE	L	■	527985
ALFA TOPCASE	XL	■	527986
ALFA TOPCASE	XXL	■	527987
ALFA 3W		■	527990
ALFA 3W TOPCASE		■	527992



Sangle réglable maintient housse en place



Volets de ventilation pour réduire la condensation



Doublure douce protège contre les rayures



Matière: **polyester 300D** (100% imperméable)



Livré dans un **sac de rangement pratique**



DS COVERS
HOUSSE DE MOTO/SCOOTER FLEXX

Housse Stretch-Fit, qui protège de la poussière et la saleté.



Désignations	Tailles	Couleurs	Réf.
FLEXX (INTÉRIEUR)	M	■	527997
FLEXX (INTÉRIEUR)	L	■	527998
FLEXX (INTÉRIEUR)	XL	■	527999
FLEXX (INTÉRIEUR)	XXL	■	528000
FLEXX TOPCASE (INTÉRIEUR)	L	■	528001
FLEXX TOPCASE (INTÉRIEUR)	XL	■	528002
FLEXX TOPCASE (INTÉRIEUR)	XXL	■	528003

Protection intérieure
 contre poussière et saleté

Ourlet élastique pour
 un ajustement douillet

Respirant
 (empêche la condensation)

Antistatique (anti-poussière)

Lavable en machine
 (30°C), ne pas repasser

 Matière: **Spandex**
 (95% polyester / 5% lycra)

 Livré dans **un sac de rangement pratique**

 Disponible dans les tailles suivantes:
Coupe régulière: M | L | XL | XXL
Coupe Topcase: L | XL | XXL

DS COVERS

HOUSSE DE MOTO/SCOOTER FOX

HOUSSE DE MOTO/SCOOTER, qui protège de la poussière et la saleté.



Désignations	Tailles	Couleurs	Réf.
FOX (INTÉRIEUR)	M	■	528004
FOX (INTÉRIEUR)	L	■	528005
FOX (INTÉRIEUR)	XL	■	528006
FOX (INTÉRIEUR)	XXL	■	528007



Protection intérieure
contre poussière et saleté



Ourlet élastique pour
un ajustement douillet



Coutures doubles



Respirant et hydrofuge



Matière: **polypropylène**



Livré dans un **sac de rangement pratique**



Disponible dans les tailles suivantes:
Coupe régulière: M | L | XL | XXL

DS COVERS

HOUSSE DE SCOOTER BARR

Housse de scooter pour la protection intérieure.



Désignations	Tailles	Couleurs	Réf.
BARR (INTÉRIEUR)	M	■	528012
BARR (INTÉRIEUR)	L	■	528013
BARR AVEC PARE BRISE (INTÉRIEUR)	M	■	528014
BARR AVEC PARE BRISE (INTÉRIEUR)	L	■	528015



Protection intérieure contre poussière et saleté



Ourllet élastique pour un ajustement douxillet



Coutures doubles.



Respirant et hydrofuge



Matière: **polypropylène**



Livré dans **un sac de rangement pratique**



Disponible dans les suivants variantes:
- **sans pare-brise** - **avec pare-brise**
tailles: **M | L**



DS COVERS

HOUSSE DE SCOOTER CUP

Housse Stretch-Fit d'intérieur, qui protège de la poussière et la saleté.



Désignations	Tailles	Couleurs	Réf.
CUP (EXTÉRIEUR)	M	■	528008
CUP (EXTÉRIEUR)	L	■	528009
CUP AVEC PARE BRISE (EXTÉRIEUR)	M	■	528010
CUP AVEC PARE BRISE (EXTÉRIEUR)	L	■	528011



Protection extérieure contre pluie, saleté, gel et UV



Ourlet élastique pour un ajustement douillet



Coutures doubles avec du ruban anti-eau



Ouvertures antivol renforcées



Sangle réglable maintient housse en place



Volets de ventilation pour réduire la condensation



Matière: **polyester 300D** (100% imperméable)



Livré dans un **sac de rangement pratique**



Disponible dans les suivants:
- **sans pare-brise**
- **avec pare-brise**
tailles: **M | L**



DS COVERS
HOUSSE DE VTT/QUAD ECHO

Pour une protection extérieur robuste



Désignations	Tailles	Couleurs	Réf.
ECHO (EXTÉRIEUR)	M	■	529151
ECHO (EXTÉRIEUR)	L	■	529152

Protection extérieure
 contre pluie, saleté, gel et UV

Ourlet élastique pour
 un ajustement douillet

Coutures doubles

Sangle réglable maintient
 housse en place

 Matière: **polyester 300D**
 (100% imperméable)

 Livré dans un **sac de rangement pratique**

 Disponible dans les tailles suivantes:
M (215 x 125 x 105 cm)
L (250 x 130 x 130 cm)



/ SUPPORT SMARTPHONE

Description	Réf.
SUPPORT SMARTPHONE ALU BLACKWAY FIXATION GUIDON	517420
SUPPORT SMARTPHONE AVEC AUTOCOLLANT	517418
SUPPORT SMARTPHONE UNIVERSEL ALU NOIR BLACKWAY FIXATION GUIDON/CHARGEUR INCLUS	517416
SUPPORT SMARTPHONE UNIVERSEL ALU NOIR BLACKWAY FIXATION RETROVISEUR/CHARGEUR INCLUS	517417
SUPPORT SMARTPHONE UNIVERSEL BLACKWAY FIXATION GUIDON	517414
SUPPORT SMARTPHONE/IPHONE DIMENSION ECRAN 5.5" (10X16CM) BLACKWAY FIXATION GUIDON	497577
SUPPORT SMARTPHONE/IPHONE DIMENSION ECRAN 5.5" (10X16CM) BLACKWAY FIXATION RETROVISEUR	497449
SUPPORT SMARTPHONE/IPHONE DIMENSION ECRAN 7" (15,5 x 8,7CM) BLACKWAY FIXATION RETROVISEUR	511641
SUPPORT SMARTPHONE/IPHONE DIMENSION ECRAN 7" (15,5 x 8,7CM) BLACKWAY FIXATION GUIDON	511642
SUPPORT SMARTPHONE/IPHONE BOX UNIVERSEL BLACKWAY FIXATION GUIDON	510918
BOX SMARTPHONE ETANCHE BLACKWAY/ CHARGEUR INDUCTION	517419



/ MANCHON

Description	TUCANO	GIWI	SHAD	DS COVER
MAXI SCOOTER NOIR GUIDON AVEC RETRO AC/SS STABILISATEUR	496068			
MAXI SCOOTER NOIR POUR GUIDON AC/SS STABILISATEUR	496067			
SCOOTER/MAXI SCOOTER NEOPRENE NOIR AC STABILISATEUR ET COMMODO INDEPENDANT	502055			
SCOOTER/CYCLO KAPPA UNIVERSEL (AVEC THERMO-DOUBLURE)		481811		
SCOOTER/CYCLO AVEC STABILISATEUR (POLYCUIR ET NEOPRENE AVEC THERMO-DOUBLURE)			495193	
SCOOTER/CYCLO NEOPRENE NOIR AVEC STABILISATEUR	476559			
SCOOTER/CYCLO NEOPRENE NOIR SANS STABILISATEUR	488103			
SCOOTER/CYCLO DS COVERS CRUISERS NEOPRENE NOIR				528016
MOTO NEOPRENE NOIR - POUR MODELE AVEC PROTEGE MAIN	507557			



/ TABLIER

Description	Réf.
MAXI SCOOTER ADAPT. 125 HONDA FORZA 2015->2018	492532
MAXI SCOOTER ADAPT. 125 HONDA FORZA 2018->- R 198 X	507072
MAXI SCOOTER ADAPT. 125 HONDA PCX ->2017	485628
MAXI SCOOTER ADAPT. 125 HONDA PCX 2018->	507071
MAXI SCOOTER ADAPT. 125 HONDA SH 2020-> -R212	508979
MAXI SCOOTER ADAPT. 125 PCX 2021->	512789
MAXI SCOOTER ADAPT. 125 PEUGEOT DJANGO	493607
MAXI SCOOTER ADAPT. 125 SUZUKI BURGMAN 2007->	485631
MAXI SCOOTER ADAPT. 125 YAMAHA NMAX 2021->	515647
MAXI SCOOTER ADAPT. 125 YAMAHA NMAX/MBK OCITO ->2020	495136
MAXI SCOOTER ADAPT. 125 YAMAHA/MBK TRICITY/TRIPTICK	499116
MAXI SCOOTER ADAPT. 125/150HONDA SWING	502374
MAXI SCOOTER ADAPT. 125/180 YAMAHA MAJESTY/MBK SKYLINER	482903
MAXI SCOOTER ADAPT. 125/200 SYM JOYRIDE/EVO	493613
MAXI SCOOTER ADAPT. 125/200/300 KYMCO DINK STREET ->2017	493611
MAXI SCOOTER ADAPT. 125/250 SYM GTS/300 GTS EVO/125 GTS EFI ->2011	482905
MAXI SCOOTER ADAPT. 125/250/300 SYM GTS 2012->	485632
MAXI SCOOTER ADAPT. 125/250/400 XMAX 2017-> (TERMOSCUUD 4 SEASON SYSTEM)	499119
MAXI SCOOTER ADAPT. 125/250/400 XMAX 2017->/EVOLIS 2017->	517000
MAXI SCOOTER ADAPT. 125/250/400 YAMAHA XMAX/MBK EVOLIS 2014->2017	486273
MAXI SCOOTER ADAPT. 125/250/500 PIAGGIO X9	485641
MAXI SCOOTER ADAPT. 125/300 HONDA FORZA 2019->	512788
MAXI SCOOTER ADAPT. 125/300 KYMCO XTOWN 2016->2018- R183	505750
MAXI SCOOTER ADAPT. 125/300 SYMJOYMAX	506237
MAXI SCOOTER ADAPT. 125/300 SYM CITYCOM	507069
MAXI SCOOTER ADAPT. 125/400 METROPOLIS (TERMOSCUUD 4 SEASON SYSTEM)	507073
MAXI SCOOTER ADAPT. 125/400/500 PIAGGIO MP3 ->2015	491658
MAXI SCOOTER ADAPT. 350 HONDA XADV	519750
MAXI SCOOTER ADAPT. 350 QUADRO 350D/S	487850
MAXI SCOOTER ADAPT. 360 KYMCO DTX	519752
MAXI SCOOTER ADAPT. 50/125 PEUGEOT CITYSTAR	493604
MAXI SCOOTER ADAPT. 50-125ELYSTAR/ELYSEO/SYM JOYRIDE/250-400 BURGMAN ->02	482904
MAXI SCOOTER ADAPT. 530 YAMAHA TMAX 2012->	485629

Description	Réf.
MAXI SCOOTER ADAPT. 530/560 YAMAHA TMAX 2017-> (TERMOSCUUD 4 SEASON SYSTEM)	499118
MAXI SCOOTER ADAPT. 550 KYMCO AK 2017-> (TERMOSCUUD 4 SEASON SYSTEM)	499120
MAXI SCOOTER ADAPT. 560 YAMAHA TMAX 2022->	519756
MAXI SCOOTER ADAPT. APRILIA 850 SRV/ GILERA GP800	507570
MAXI SCOOTER ADAPT. KYMCO 125 GRAND DINK/DINK/SPACER - R029	507967
MAXI SCOOTER ADAPT. KYMCO 125 XTOWN CITY /GRAND DINK E4 2019-> - R211	507973
MAXI SCOOTER ADAPT. KYMCO 300 AGILITY CITY 2019->-> - R210	508978
MAXI SCOOTER ADAPT. KYMCO PEOPLE/SYM 125 HD/HONDA 125 SH ->2008- R049	507968
MAXI SCOOTER ADAPT. MBK CITYLINER/KILIBRE/PIEAGGIO BERVERLY/XCITY - R152	507969
MAXI SCOOTER ADAPT. PEUGEOT SATELIS	482902
MAXI SCOOTER ADAPT. PIAGGIO 125/150 MEDLEY2020-> - R214	508981
MAXI SCOOTER ADAPT. PIAGGIO 50/125 VESPALX/LXV/S - R153	507970
MAXI SCOOTER ADAPT. PIAGGIO MP3 HPE 2018-> - R207	507972
MAXI SCOOTER ADAPT. PIAGGIO MP3 YOURBAN	499115
MAXI SCOOTER ADAPT. PIAGGIO VESPA PK/PX/HP - R013	507966
MAXI SCOOTER ADAPT. PIAGGIO X10	493608
MAXI SCOOTER ADAPT. PIAGGIO X8/XEVO	482900
MAXI SCOOTER ADAPT. SYM 50/125 FIDDLE 2 ET 3 - R205	507971
MAXI SCOOTER ADAPT. SYM MAXSYM 500 TL2020-> - R213	508980
MAXI SCOOTER ADAPT. VESPA GT/GTS/GTV	485630
MAXI SCOOTER ADAPT. VESPA PRIMAVERA/SPRINT 2014->	503186
MAXI SCOOTER ADAPT. YAMAHA 300 TRICITY2020-> - R216 PRO	508982
MAXI SCOOTER ADAPT. YAMAHA CYGNUS X/MBK FLAMEX X	493605
MAXI SCOOTER ADAPT. YAMAHA XMAX/MBK SKYCRUISER ->2010	482898
MAXI SCOOTER ADAPT. YAMAHA XMAX/MBK SKYCRUISER 2010->2013	482899
MAXI SCOOTER PRO ADAPT. 125/300 HONDA FORZA 2019->	512787
MAXI SCOOTER PRO ADAPT. HONDA 750 FORZA 2021->	512791
MAXI SCOOTER PRO ADAPT. HONDA 750 XADV 2021->	512790
MAXI SCOOTER/SCOOTER LINUSCUUD A PORTER UNIVERSEL	499722
MAXI SCOOTER/SCOOTER ADAPT. 50/125 KYMCO AGILITY S	519754
MAXI SCOOTER/SCOOTER ADAPT. 50/125/200 SYM SYNPHONY ST	519749
MAXI SCOOTER/SCOOTER PASSAGER -R091	507554
MOTO/MAXI SCOOTER PASSAGER -R092	507555
SCOOTER ADAPT. OVETTO/STUNT/FLY/ET2/ET4/VIVACITY/MIO/KISBEE - R151	483877
MAXI SCOOTER ADAPT. 400 KYMCO XCITING S ->2018- R192	505752

VISUELS TABLIER



MOTEUR

CYCLE

PNEUMATIQUE

ATELIER

ACCESSOIRES

ÉLECTRICITÉ

FILTRATION

FREINAGE

TRANSMISSION



517000



486273



485641



512788



505750



506237



507069



507073



491658



519750



487850



519752



493604



482904



485629



499118



499120



519756



507570



507967



507973



508978



507968



507969



482902



508981



507970



507972



499115



507966



493608



482900



507971



508980



485630



503186

MOTEUR

CYCLE

PNEUMATIQUE

ATELIER

ACCESSOIRES

ÉLECTRICITÉ

FILTRATION

FREINAGE

TRANSMISSION



508982



493605



482898



482899



512787



512791



512790



499722



519754



519749



507554



507555



483877



505752



/ POMPE TABLIER



Description	Réf.
POMPE POUR TABLIER TUCANO SYSTEME SGAS	507553



493738



502029



/ STABILISATEUR TABLIER

Description	Réf.
STABILISATEUR TABLIER TUCANO - 62 CM	493738
STABILISATEUR TABLIER TUCANO - 72 CM	502029
STABILISATEUR TABLIER TUCANO -79 CM (MODELE PRO)	518460
STABILISATEUR TABLIER TUCANO - 82 CM	503624



503624



518460



486148



486153



486152



486150



486147



486151



486154



486149



501230



501229



501231



294213



/ LUNETTE/MASQUE CROSS

Description	PRO GRIP
LUNETTE/MASQUE CROSS PROGRIP 3201 DUAL ARGENT ANTI-RAYURE/ANTI UV - HOMOLOGUE CE	486148
LUNETTE/MASQUE CROSS PROGRIP 3201 DUAL BLANC ANTI-RAYURE/ANTI UV - HOMOLOGUE CE	486153
LUNETTE/MASQUE CROSS PROGRIP 3201 DUAL BLEU ANTI-RAYURE/ANTI UV - HOMOLOGUE CE	486152
LUNETTE/MASQUE CROSS PROGRIP 3201 DUAL JAUNE ANTI-RAYURE/ANTI UV - HOMOLOGUE CE	486150
LUNETTE/MASQUE CROSS PROGRIP 3201 DUAL NOIR ANTI-RAYURE/ANTI UV - HOMOLOGUE CE	486147
LUNETTE/MASQUE CROSS PROGRIP 3201 DUAL ORANGE ANTI-RAYURE/ANTI UV - HOMOLOGUE CE	486151
LUNETTE/MASQUE CROSS PROGRIP 3201 DUAL ROUGE ANTI-RAYURE/ANTI UV - HOMOLOGUE CE	486154
LUNETTE/MASQUE CROSS PROGRIP 3201 DUAL VERT ANTI-RAYURE/ANTI UV - HOMOLOGUE CE	486149
LUNETTE/MASQUE CROSS PROGRIP 3204 NOIR MAT/ECRAN ARGENT MIROIR ANTI-RAYURE/ANTI UV - HOMOL	501230
LUNETTE/MASQUE CROSS PROGRIP 3204 NOIR MAT/ECRAN BLEU MIROIR ANTI-RAYURE/ANTI UV - HOMOLOG	501229
LUNETTE/MASQUE CROSS PROGRIP 3204 NOIR MAT/ECRAN ROUGE MIROIR ANTI-RAYURE/ANTI UV - HOMOLO	501231
LUNETTE/MASQUE CROSS PROGRIP 3301 NOIR ANTI-BUEE/RAYURE - HOMOLOGUE CE	294213



506392



506408



506391



506393



506396



506395

trendy

/ LUNETTE/MASQUE CROSS

Description	TRENDY
LUNETTE/MASQUE CROSS TRENDY CAMO BLANC- HOMOLOGUE CE	506399
LUNETTE/MASQUE CROSS TRENDY CAMO NOIR MATT- HOMOLOGUE CE	506397
LUNETTE/MASQUE CROSS TRENDY CAMO ROUGE MATT- HOMOLOGUE CE	506398
LUNETTE/MASQUE CROSS TRENDY MTC01 BLANC - HOMOLOGUE CE	506392
LUNETTE/MASQUE CROSS TRENDY MTC01 BLEU - HOMOLOGUE CE	506408
LUNETTE/MASQUE CROSS TRENDY MTC01 NOIR - HOMOLOGUE CE	506391
LUNETTE/MASQUE CROSS TRENDY MTC01 NOIR MAT- HOMOLOGUE CE	506393
LUNETTE/MASQUE CROSS TRENDY MTC01 ORANGE FLUO - HOMOLOGUE CE	506396
LUNETTE/MASQUE CROSS TRENDY MTC01 ROUGEMAT- HOMOLOGUE CE	506395



441926



490527



490528

/ LUNETTE/MASQUE ENFANT

Description	PRO GRIP
LUNETTE/MASQUE CROSS PROGRIP ENFANT 3101 NOIR ECRAN ANTI BUEE - HOMOLOGUE CE	441926
LUNETTE/MASQUE CROSS PROGRIP ENFANT 3101 ROUGE ECRAN ANTI BUEE - HOMOLOGUE CE	490527
LUNETTE/MASQUE CROSS PROGRIP ENFANT 3101 VERT ECRAN ANTI BUEE - HOMOLOGUE CE	490528



521258



521262



521257



521259



521260



521261



/ LUNETTE / MASQUE CROSS ADRENALINE PRIMIS

Modèle	Réf.
BLEU / JAUNE ANTI-RAYURE / ANTI UV- HOMOLOGUE CE	521258
BLEU / VERT ANTI-RAYURE / ANTI UV- HOMOLOGUE CE	521262
NOIR / BLANC ANTI-RAYURE / ANTI UV - HOMOLOGUE C	521257

Modèle	Réf.
NOIR / CAMO ANTI-RAYURE / ANTI UV - HOMOLOGUE C	521259
NOIR / JAUNE ANTI-RAYURE / ANTI UV - HOMOLOGUE C	521260
NOIR / ORANGE ANTI-RAYURE / ANTI UV - HOMOLOGUE	521261



501236

465706

501227

501228

171140

481755

460233

374748

/ ECRAN LUNETTE 3101/3201/3204/3301/3400/3450

Description	Réf.
LIGHT SENSITIVE	501236
MIROIR ARGENT SIMPLE ECRAN	465706
POLARISE SIMPLE ECRAN	501227
RAINBOW SIMPLE ECRAN	501228

Description	Réf.
TRANSPARENT SIMPLE ECRAN	171140
FUME SIMPLE ECRAN	481755
MIROIR BLEU SIMPLE ECRAN	460233
TRANSPARENT DOUBLE ECRAN	374748

/ ECRAN JETABLE

Description	Réf.
ECRAN JETABLE LUNETTE PROGRIP - TEAR OFF (X10)	171154

/ FILM/LENTILLE ANTI-BUEE

Description	Réf.
30 - TRANSPARENTE	515218
70 - TRANSPARENTE	515219
70 - TRANSPARENTE POUR MODELE TRENDY T-406	519549

/ FILTRE MASQUE

Description	Réf.
FILTRE POUR MASQUE ANTI POLLUTION	497398

/ MASQUE DE CONFORT

Description	Réf.
EN NEOPRENE AVEC SYSTEME ANTI POLLUTION (AVEC CAPSULE CHARBON ACTIF)	497397



509018

/ SOUS CASQUE INTERIEUR

496749

508032

Description	Réf.
ETANCHE NEOPRENE - TAILLE UNIQUE -	509018
OSIER 344 PANAMA- TAILLE UNIQUE	496749
TISSUS COTTON PAPAM - LAVABLE- TU - PAR 2	508032

/ TOUR DE COU

Description	Réf.
TOUR DE COU TUCANO NECKWARM CHAUFFANT	509019





509830



509832



472501



492713



472502



492715



472505



492716



/ AUTOCOLLANT CASQUE



512065



512063

Désignation	Réf.
o Réfléchissant - Blanc (sachet de 4)	512065
• Réfléchissant - Noir (sachet de 4)	512063



/ AUTOCOLLANT CASQUE

Désignation	Réf.
Réfléchissant - Noir (sachet de 4)	497241



492551



501951

SHAD / PLATINE POUR TOP CASE

Description	Réf.
26L/29L/32L/33L NOIR	492551
39L/40L/45L/46L NOIR	501951

/ TOP CASE

Description	SELECTION CGN MOTORISE	SHAD
28L NOIR (CAPACITE 1 CASQUE INTEGRAL)	509830	
32L NOIR (CAPACITE 1 CASQUE INTEGRAL)	509832	
26L NOIR (CAPACITE 1 CASQUE INTEGRAL)		472501
29L NOIR (CAPACITE 1 CASQUE INTEGRAL)		492713
37L NOIR (CAPACITE 2 CASQUES - JET+INTEGRAL)		472502
39L NOIR (CAPACITE 2 CASQUES - JET+INTEGRAL)		492715
40L CARGO NOIR (CAPACITE 2 CASQUES - JET+INTEGRAL)		472505
45L NOIR (CAPACITE 2 CASQUES INTEGRAUX)		492716



488034



479513

506222

/ DOSSERET POUR TOP CASE

Description	Réf.
26/29/33/34 L	488034
37/40/45/49L	479513
39L	506222

PORTE BAGAGE / SUPPORT TOP CASE

SHAD

Modèle	Cylindre	Année début	Année fin	Référence
APRILIA				
SPORT CITY ONE 125	125	2009	2016	483465
SPORT CITY ONE 4T 125	125	2010	2016	483465
SR 125/200 GT	125	2021	2023	526368
SR MAX 125	125	2012	2017	526369
SR125 MOTARD	125	2011	2019	483465
SR MAX 300	300	2012	2017	526369
TUAREG 660	660	2021	2023	526370
BENELLI				
BN125	125	2018	2023	526371
LEONCINO 125	125	2022	2023	526374
LEONCINO 250	250	2019	2023	526374
TRK 125/251	251	2019	2023	526377
BN302 / TNT300	300	2015	2023	526372
BN302S	302	2019	2023	526373
LEONCINO TRAIL	500	2017	2023	526375
TRK 502	500	2016	2023	526377
LEONCINO 502i	502	2017	2023	526375
TRK 502X	502	2018	2023	526377
LEONCINO 800 /TRAIL	800	2021	2023	526376
BMW				
CE 04	125	2022	2023	526384
G310GS	300	2017	2023	526393
G310R	300	2017	2023	526394
C400GT	400	2019	2023	526380
C400X	400	2018	2023	526381
C EVOLUTION ELECTRIC	600	2015	2021	526379
C600	600	2015	2023	526382
C600 SPORT	600	2011	2023	526382
C650GT	600	2012	2022	526383
DAKAR	650	2004	2007	526385
DAKAR	650	2013	2013	526385
F650GS	650	2004	2018	526385
G650GS	650	2010	2016	526385
F700GS	700	2008	2018	526386
F750GS	750	2018	2023	526387
F750GS	750	2018	2023	526388
F800GS	800	2008	2018	526386
F800GT	800	2013	2020	526389
F800R	800	2009	2022	526390
F800S	800	2007	2015	526390
F850GS	850	2018	2023	526387
F850GS	850	2018	2023	526388
F850GS ADVENTURE	850	2019	2023	526391
F900R	900	2020	2023	526392



PORTE BAGAGE / SUPPORT TOP CASE

SHAD

Modèle	Cylindre	Année début	Année fin	Référence
F900XR	900	2020	2023	526392
SI000XR	1000	2015	2023	526401
SI000XR	1000	2020	2023	526402
SI000XR	1000	2020	2023	526403
K1100LT	1100	1996	2005	526395
R110RT	1100	1996	2006	526395
R1150RS	1150	1996	1996	526395
R1150RT	1150	1996	2005	526395
R1200 /R/RS	1200	2015	2019	526397
R1200 GS	1200	2013	2019	526399
R1200GS ADVENTURE	1200	2014	2018	526391
R1200RT	1200	2008	2018	526396
R1250GS	1250	2019	2022	526399
R1250GS ADVENTURE	1250	2019	2022	526391
R1250R	1250	2019	2022	526397
R1250R	1250	2019	2022	526398
R1250RS	1250	2019	2022	526397
R1250RS	1250	2019	2022	526398
R1250RT	1250	2019	2022	526400
K1600GT	1600	2012	2017	526396
CAN AM				
SPIDER F3/F3S	1330	2016	2023	526404
CF MOTO				
400GT/650GT	400	2019	2023	526405
650MT	650	2020	2023	526406
700CL-X	700	2021	2023	526407
800MT	800	2022	2023	526408
DAELIM				
ROADWIN 125R/ 250R	125	2006	2012	526409
S2 125	125	2006	2017	526410
S3 125	125	2010	2023	526411
XQ1 125/250	125	2018	2023	503682
ROADWIN 125Fi/ 250Fi	250	2006	2014	526409
S2 250	250	2006	2017	526410
S3 250	250	2010	2023	526411
XQ2 300	300	2021	2023	503682
DERBI				
BOULEVARD 125	125	2010	2014	526412
BOULEVARD TWO	125	2010	2010	526412
VARIANT SPORT 125 4T	125	2012	2014	483465
BOULEVARD 250	250	2010	2014	526412
DUCATI				
MULTISTRADA 950	937	2017	2023	526413
MULTISTRADA 1200 / Enduro	1200	2016	2023	526413
MULTISTRADA V4 S1200	1200	2021	2023	526414

PORTE BAGAGE / SUPPORT TOP CASE

SHAD

Modèle	Cylindre	Année début	Année fin	Référence
MULTISTRADA 1260/ENDURO	1260	2018	2023	526413
GENERIC				
WORX 125	125	2014	2014	526415
GILERA				
NEXUS 125	125	2007	2023	526369
RUNNER 125	125	2003	2023	526417
RUNNER 50SP VX 125	125	2003	2018	526417
RUNNER 150	150	2003	2023	526417
RUNNER 50SP VX 150	150	2003	2018	526417
RUNNER 200	200	2003	2023	526417
RUNNER 50SP VX 200	200	2003	2018	526417
NEXUS 250	250	2006	2014	526369
NEXUS 300	300	2013	2023	526369
FUOCO 500	500	2007	2023	526416
NEXUS 500	500	2006	2014	526369
HARLEY DAVIDSON				
PAN AMERICAN	1250	2021	2023	526418
HONDA				
CB 125R NEO SPORTS CAFE	125	2018	2023	526423
CB125F	125	2015	2022	526424
CBR 125R	125	2011	2017	527379
CBF 125	125	2008	2014	526433
DYLAN SES 125	125	2002	2008	526439
FORZA 125	125	2015	2023	495908
FORZA 125	125	2021	2022	519337
MSX 125	125	2017	2020	503680
PCX 125	125	2010	2022	501126
SH-MODE 125	125	2014	2023	526451
SH125	125	2017	2022	519338
VISION 125	125	2011	2022	526450
DYLAN SES 150	150	2002	2008	526439
CBF 250	250	2004	2008	526434
CBR 250R	250	2011	2017	527379
CRF 250L	250	2012	2017	526437
CB300F	300	2011	2016	527379
CBR 300R	300	2011	2016	527379
FORZA 300	300	2013	2017	526441
FORZA 300	300	2018	2023	495908
SH300	300	2019	2020	526453
ADV 350	350	2022	2023	495908
FORZA 350	350	2021	2022	519337
SH350	350	2021	2022	526454
CB500F	500	2013	2023	526426
CBF 500	500	2004	2008	526431
CB500X	500	2013	2023	511864



PORTE BAGAGE / SUPPORT TOP CASE

SHAD

Modèle	Cylindre	Année début	Année fin	Référence
CBR500R	500	2014	2023	526426
CBF 600 S/N	600	2004	2012	526431
CBR 600F	600	2001	2008	526436
HORNET CB600F	600	2007	2010	526445
CB650F	650	2014	2019	526429
CB650R	650	2019	2022	526430
CBR650F	650	2013	2018	526429
CBR650R	650	2019	2022	526430
CTX700	700	2014	2018	526438
INTEGRA 700	700	2012	2022	526446
INTEGRA 700	700	2012	2022	526447
NC700S	700	2012	2015	526446
NC700S	700	2012	2015	526447
X-ADV 750	745	2017	2020	526457
X-ADV 750	745	2017	2020	526458
X-ADV 750	745	2021	2022	526442
FORZA 750	750	2021	2022	526442
FORZA 750	750	2021	2022	526443
INTEGRA 750	750	2014	2022	526446
NC750S	750	2016	2019	526449
NC750X	750	2014	2015	526446
NC750X	750	2014	2015	526447
NC750X	750	2016	2022	526449
VFR 800	800	2005	2013	526455
VFR 800 VTEC	800	2002	2004	526455
VFR 800X CROSSRUNNER	800	2015	2022	526456
NT1100	863	2022	2023	526443
AFRICA TWIN ADVENTURE SPORTS CRF1000L	1000	2018	2022	526419
AFRICA TWIN CRF1000L	1000	2016	2022	526421
CBF 1000	1000	2005	2013	526431
AFRICA TWIN ADVENTURE SPORTS CRF1100L SPECIAL EDITION	1100	2021	2022	526420
CBR 1100 XX	1100	1997	2007	526435
VRF 1200X CROSSTOURER	1200	2012	2022	526421
GOLDWING GL1800	1800	2018	2023	526444
HUSQVARNA				
NORDEN 901	901	2022	2023	526459
KAWASAKI				
J125	125	2016	2017	526464
Z125	125	2019	2023	526474
J300	300	2013	2023	526464
VERSYS-X 300	300	2017	2023	526471
Z400	400	2019	2023	526475
ER6 N-F	600	2005	2017	526460
NINJA 650	650	2017	2022	526467
VERSYS 650	650	2007	2009	526468

PORTE BAGAGE / SUPPORT TOP CASE

SHAD

Modèle	Cylindre	Année début	Année fin	Référence
VERSYS 650	650	2010	2014	526469
VERSYS 650	650	2015	2023	526470
Z650	650	2016	2022	526467
Z650RS	650	2021	2023	526476
ZR-7 S	738	2001	2005	526479
Z750	750	2007	2012	526472
ZR-7	750	2001	2005	526479
Z900RS	900	2018	2023	526478
Z900RS CAFE	900	2020	2023	526478
Z900	948	2017	2022	526477
KLV 1000	1000	2005	2007	526465
NINJA 1000 SX	1000	2021	2023	526466
VERSYS 1000	1000	2012	2023	526463
Z1000 K	1000	2007	2009	526472
Z1000SX	1000	2011	2021	526473
GTR 1400 / CONCOURS 1400	1400	2007	2017	526463

KEEWAY

FACT EVO 125	125	2021	2023	526480
RKF 125	125	2018	2023	526481
RKS 125	125	2011	2023	526415
SILVER BLADE 125	125	2012	2017	526482
VIESTE 125/300	125	2020	2023	526483
ZAHARA 125	125	2021	2023	526484
RKV 125	125	2011	2023	504709
RKS 150/200/200S	200	2011	2023	526415
RKV 150/200S/200S FACTORY	200	2011	2023	504709

KTM

DUKE 125	125	2011	2016	524532
DUKE 125	125	2017	2023	526487
DUKE 200	200	2011	2016	524532
DUKE 200	200	2018	2023	524532
DUKE 200	200	2017	2018	526487
DUKE 250	250	2017	2023	526487
DUKE 390	390	2011	2016	524532
DUKE 390	390	2017	2023	526487
DUKE 390 ADVENTURE	390	2020	2023	526488
790 ADVENTURE / 790 R	790	2019	2020	526459
890 ADVENTURE L/R/RALLY	890	2021	2023	526459
1050 ADVENTURE	1050	2014	2016	526459
ADVENTURE 1090 R / CLASSIC	1050	2014	2019	526459
1190 ADVENTURE / R	1190	2013	2016	526485
1290 SUPER ADVENTURE R/S/T	1290	2014	2023	526459
1290 SUPER ADVENTURE R/S/T	1290	2021	2023	526486

KYMCO

AGILITY 125 RS	125	2010	2022	501136
----------------	-----	------	------	--------



PORTE BAGAGE / SUPPORT TOP CASE

SHAD

Modèle	Cylindre	Année début	Année fin	Référence
AGILITY CITY 125i 16/4T	125	2014	2023	501137
AGILITY S 50/125/200	125	2022	2023	520974
DTX 125/360	125	2021	2023	526490
FILLY 125	125	2018	2023	503685
GRAND DINK 125	125	2016	2023	501139
K-XCT 125i	125	2013	2017	526491
LIKE 125	125	2015	2020	526492
PEOPLE 125	125	2018	2023	526494
SUPER 8 50/125/150	125	2021	2023	526495
SUPER DINK/DOWNTOWN 125/350/350i	125	2016	2023	501138
X-TOWN 125i	125	2016	2021	501139
X-TOWN 125i	125	2022	2023	526498
AGILITY CITY 200i 16/4T	200	2014	2023	501137
XCITING 250	250	2005	2015	526499
GRAND DINK 300	300	2016	2023	501139
K-XCT 300i	300	2013	2017	526491
SUPER DINK/DOWNTOWN/DINK STREET 125/300	300	2009	2015	526496
SUPER DINK/DOWNTOWN/DINK STREET 125/300	300	2009	2015	495914
X-TOWN 125/300 CITY/CT	300	2022	2023	526498
X-TOWN 300i	300	2016	2021	501139
XCITING 400	400	2013	2017	526500
XCITING 400S	400	2018	2023	503681
XCITING 500 / 500R	500	2005	2015	526499
AK 550	550	2017	2023	526489
CV3 550	550	2022	2023	520972
LINHAI				
BUCK 125	125	2021	2021	526501
MACBOR				
EIGHT MILLE 500 SCRAMBLER/STREET	500	2022	2023	526502
MONTANA XR5 500	5000	2020	2023	526503
MALAGUTI				
DUNE 125 ADVENTURE/X BLACK EDITION	125	2018	2023	526504
MADISON 125	125	2022	2023	526505
MASH				
FIFTY EURO 5	125	2021	2023	507400
SEVENTY-FIVE	125	2017	2020	507400
MITT				
125 GT MAX	125	2018	2023	507400
125 GT MAX	125	2018	2023	526506
MOTO GUZZI				
V85TT	850	2019	2023	526507
MOTO MORINI				
X-CAPE 649	649	2022	2023	526508
NERVA				
EXE	125	2022	2023	526509

PORTE BAGAGE / SUPPORT TOP CASE

SHAD

Modèle	Cylindre	Année début	Année fin	Référence
NIU				
M+ SPORT ELECTRICA	125	2019	2023	507399
M+ SPORT ELECTRICA	125	2020	2023	507399
MQiGT	125	2021	2023	519624
N SERIES ELECTRICA	125	2018	2023	504734
PEUGEOT				
ELYSTAR 125	125	2002	2012	526510
PULSION 125	125	2018	2023	526511
VIVACITY 125	125	1999	2007	503934
ELYSTAR 150	150	2002	2012	526510
CITYSTAR 125i/200i	200	2012	2023	495911
PIAGGIO				
BEVERLY 125	125	2009	2018	526512
BEVERLY TOURER 125 /250	125	2008	2023	526512
FLY 125	125	2005	2014	526412
LIBERTY 125	125	2005	2023	526515
LX 125	125	2005	2014	526516
MEDLEY 125/150	125	2016	2023	495910
MP3 125	125	2007	2021	501132
MP3 HYBRID 125 LT	125	2007	2021	501132
ONE ELECTRICA	125	2022	2023	526518
TYPHOON 125	125	2011	2023	508107
VESPA GTS SUPER 125/300	125	2019	2023	526519
VESPA PRIMAVERA 50/SI150 /125 AB/150 AB /SPRINT 125/150	125	2014	2023	526520
ZIP 125	125	2009	2014	483463
FLY 150	150	2005	2014	526412
MP3 250	250	2007	2021	501132
MP3 RL	250	2007	2021	501132
BEVERLY 300/400/300S/400S	300	2021	2023	526513
MP3 125/300 YOURBAN	300	2011	2018	501134
MP3 300 HPE / 300 HPE SPORT	300	2011	2023	501134
MP3 300 YOURBAN / SPORT 300	300	2011	2023	501134
MP3 HYBRID 300 LT	300	2007	2021	501132
BEVERLY SPORT TOURING 350	350	2013	2021	526512
MP3 300/350/500 BUSINESS LT/SPORT	350	2018	2023	503683
BEVERLY TOURER 300 /400	400	2008	2023	526512
MP3 400	400	2007	2021	501132
MP3 400 / MP3 SPORT 400 / MP3 EXCLUSIVE 530	400	2022	2023	520975
MP3 400 HPE EURO 5 / MP3 Sport 400 EURO 5 / MP3 SPORT ADVANCE 500 EURO 5	400	2022	2023	503683
MP3 500	500	2011	2017	501132
MP3 500 SPORT/BUS	500	2014	2017	501133
MP3 500i Sport	500	2010	2010	501132
QJMOTOR				
SRT550	550	2022	2023	526378
SRK 700	700	2022	2023	526521



PORTE BAGAGE / SUPPORT TOP CASE					SHAD
Modèle	Cylindre	Année début	Année fin	Référence	
SRT800/X	800	2022	2023	526522	
SRV550	898	2022	2023	526523	
QUADRO					
3D 350	350	2013	2016	496742	
3D 350S	350	2014	2023	496742	
ROYAL ENFIELD					
HIMALAYAN 410	410	2018	2023	526524	
SEAT					
MO 125/PERFORMANCE	125	2020	2023	526526	
SILENCE					
S01	125	2020	2023	526526	
SUPER SOCO					
CPX	125	2020	2023	526527	
CUX	125	2019	2023	526528	
TC MAX	125	2019	2023	510186	
SUZUKI					
BURGMAN 125 / UH 125	125	2002	2006	526532	
BURGMAN 125 / UH 125	125	2007	2020	501129	
BURGMAN 125R	125	2007	2013	501129	
GSX R/S 125	125	2017	2021	526543	
BURGMAN 150	150	2002	2007	526532	
BURGMAN 200 / UH 200	200	2007	2019	501129	
BURGMAN 250/BUSINESS	250	2001	2009	526533	
V-STROM 250	250	2017	2022	526551	
BURGMAN 400	400	2001	2006	526533	
BURGMAN 400	400	2007	2016	526534	
BURGMAN 400	400	2017	2023	526535	
BURGMAN 400 ABS	400	2010	2016	526534	
BURGMAN 400 K7	400	2006	2007	526534	
GS500	500	2001	2011	526538	
GS500 E	500	1989	2000	526539	
GS500 F	500	2001	2011	526538	
BANDIT GSF600	600	2000	2004	526530	
BANDIT GSF600 N	600	1994	1999	526529	
GSR-600	600	2005	2011	526541	
GSX 600 F	600	1998	2004	526542	
BANDIT 650 ABS1	650	2011	2017	526531	
BANDIT 650 N/S	650	2005	2017	526531	
BANDIT GSX 650F	650	2008	2017	526531	
BURGMAN 650	650	2002	2014	526536	
BURGMAN 650 EXECUTIVE	650	2004	2022	526536	
GLADIUS 650	650	2009	2016	526537	
GSX 650F	650	2011	2011	526531	
SV650 / SV650X	650	1999	2022	526548	
SV650 / SV650X	650	2016	2023	526549	

PORTE BAGAGE / SUPPORT TOP CASE

SHAD

Modèle	Cylindre	Année début	Année fin	Référence
V-STROM 650/XT	650	2004	2011	526465
V-STROM 650/XT	650	2012	2016	526552
V-STROM 650/XT	650	2017	2023	526550
BANDIT 750	750	1996	1997	526529
GSR 750	750	2011	2017	526540
GSX 750 F	750	1998	2002	526542
GSX-S 750	750	2017	2022	526544
GSX-S 750	750	2017	2022	526545
GSX-SI000GT	1000	2022	2023	526546
KATANA 1000	1000	2018	2023	526547
V-STROM 1000	1000	2002	2013	526465
V-STROM 1000	1000	2014	2019	526550
V-STROM 1050/XT	1050	2020	2022	526550
BANDIT 1200 N/S	1200	1996	2004	526529
BANDIT GSF 1200S	1200	2005	2014	526531
BANDIT GSF 1250	1250	2007	2014	526531
BANDIT GSX 1250 N/FA	1250	2011	2017	526531
SYM				
CRUISYM 125i/300i	125	2018	2023	503684
GTS 125	125	2005	2017	526553
JET 14	125	2015	2023	515118
JET X 125	125	2021	2022	515118
JOYMAX Z+ 125/300	125	2021	2023	503684
SYMPHONY 50/125 S-LX-SR	125	2015	2023	526558
SYMPHONY ST 125	125	2021	2023	526558
SYMPHONY ST 200 ABS	200	2018	2023	526558
GTS 250	250	2005	2017	526553
JOYMAX 125/125i/250i	250	2013	2020	499510
GTS 300	300	2010	2017	526553
HD 300	300	2019	2022	526554
JOYMAX 300i	300	2013	2022	499510
MAXSYM 400	400	2011	2020	526555
MAXSYM 400	400	2021	2023	526556
MAXSYM 500 TL	500	2020	2023	526557
MAXSYM 600i ABS	600	2014	2021	526555
TRIUMPH				
TIGER 660	660	2022	2023	526559
TIGER 800 XC/XR/XRX	800	2011	2022	526560
TIGER SPORT 1050	1050	2015	2022	526562
TIGER EXPLORER 1200	1200	2017	2021	526561
UM				
DSR ADVENTURE 125 EFI	125	2018	2023	526504
DSR ADVENTURE TT 125 EFI	125	2018	2023	526504
SCRAMBLER	125	2017	2023	526504
VOGE				
300AC	300	2020	2023	526563



PORTE BAGAGE / SUPPORT TOP CASE

SHAD

Modèle	Cylindre	Année début	Année fin	Référence
300R	300	2020	2023	526564
SR4 MAX	350	2022	2022	526570
500AC	500	2021	2022	526565
500DS	500	2020	2022	526566
500DSX	500	2020	2022	526566
500R	500	2020	2022	526567
650DS	650	2021	2022	526568
650DSX	650	2021	202	526568
650DSX	650	2021	2022	526569

WOTTAN

STORM T125	125	2018	2022	526506
STORM S300	300	2022	2022	526509

YAMAHA

CYGNUS X 125	125	2004	2006	526572
CYGNUS X 125	125	2007	2016	492245
MAJESTY 125	125	2014	2016	526585
MAJESTY 125S	125	2014	2017	526585
NEOS 125	125	2008	2022	491682
NMAX 125	125	2015	2020	495145
NMAX 125	125	2021	2022	519340
SMAX 155	125	2014	2016	526585
TRICITY 125	125	2014	2022	495909
X-MAX 125	125	2005	2009	526607
X-MAX 125	125	2010	2013	491683
X-MAX 125	125	2014	2016	491685
X-MAX 125	125	2017	2020	501127
X-MAX 125	125	2021	2022	519339
XSR 125	125	2019	2022	526610
YS 125	125	2017	2021	526612
NMAX 155	155	2021	2022	519340
X-MAX 250	250	2005	2009	526607
X-MAX 250	250	2010	2013	491683
X-MAX 250	250	2014	2017	491685
MT03	300	2015	2020	526587
MT03	300	2021	2021	526588
TRICITY 300	300	2020	2022	526606
X-MAX 300	300	2017	2021	501127
YZF-R3	321	2016	2017	526587
MAJESTY 400	400	2004	2006	526586
MAJESTY 400	400	2010	2012	526586
X-MAX 400	400	2014	2016	491685
X-MAX 400	400	2017	2021	501127
T-MAX 500	500	2001	2007	526598
T-MAX 500	500	2008	2012	518128
T-MAX 530	530	2012	2016	491684

PORTE BAGAGE / SUPPORT TOP CASE

SHAD

Modèle	Cylindre	Année début	Année fin	Référence
T-MAX 530	530	2017	2020	501128
TMAX 560	560	2020	2021	501128
TMAX 560 Tech MAX	560	2022	2022	526600
DIVERSION XJ6 ABS	600	2009	2016	526576
FAZER 600	600	2001	2003	526579
FAZER FZ6 N	600	2004	2012	526580
FAZER FZ6 S 600	600	2004	2012	526580
XT660 R	660	2004	2016	526611
MT07	700	2013	2022	526589
MT07	700	2017	2022	526589
TENERE 700	700	2019	2022	526599
TRACER 7	700	2021	2022	526601
TRACER 700	700	2016	2020	526601
TRACER 700 GT	700	2019	2022	526602
FAZER FZ8	800	2010	2016	526581
MT09	850	2013	2016	526590
MT09	850	2017	2019	526591
MT09	850	2021	2021	526592
DIVERSION XJ 900 SN	900	1994	2003	526575
MT09 SP	900	2018	2021	526591
MT09 TRACER	900	2015	2017	526593
NIKEN 900	900	2018	2022	526595
TRACER 9/GT	900	2021	2022	526603
TRACER 9/GT	900	2021	2022	526604
TRACER 900 / GT	900	2018	2020	526605
FAZER 1000	1000	2001	2005	526577
FAZER 1000	1000	2006	2015	526578
FZ1	1000	2006	2015	526578
MT10	1000	2016	2021	526594
FJR 1300	1300	2001	2005	526582
FJR 1300	1300	2006	2022	526583
XJR 1300	1300	1998	2006	526609
ZONTES				
G1-125/X/SCRAMBLER 125	125	2020	2022	526613
GK125/X	125	2022	2022	526613
M125	125	2022	2022	526614
U/UJ/HYPER TRAIL 125	125	2020	2022	526616
Z2/ZT 125	125	2021	2022	526617
M310	310	2021	2022	526614
T310/T2-310	310	2019	2022	526615
T350/T350X	350	2022	2022	526615



483463



483465



491682



491683



491684



491685



492245



495145



495908



495909



495910



495911



496742



501126



501127



501128



501139



503680



503681



503682



503683



503684



503685



504734



507399



508107



510186



519337



519338



519339



519340



519624



520974



520975



524532



526368



526370



526371



526372



526373



526374



526375

MOTEUR

CYCLE

PNEUMATIQUE

ATELIER

ACCESSOIRES

ÉLECTRICITÉ

FILTRATION

FREINAGE

TRANSMISSION



526376



526377



526378



526379



526380



526381



526382



526383



526384



526386



526387



526388



526389



526391



526392



526393



526394



526397



526398



526400



526401



526402



526403



526404



526405



526406



526407



526408



526413



526414



526417



526418



526419



526420



526423



526424



526426



526429



526430



526438



526441



526442



526443



526444



526446



526447



526449



526451



526453



526454



526456



526458



526459



526463



526464



526466



526467



526469



526470



526471



526473



526474



526475



526476



526477



526478



526480



526481



526483



526484



526485



526486



526487



526488



526489



526490



526491



526492



526494



526495



526498



526500



526501



526502



526503



526504



526505



526506



526507



526508



526509



526510



526511



526512



526513



526518

MOTEUR

CYCLE

PNEUMATIQUE

ATELIER

ACCESSOIRES

ÉLECTRICITÉ

FILTRATION

FREINAGE

TRANSMISSION



526519



526520



526521



526522



526523



526524



526526



526527



526528



526533



526534



526535



526540



526543



526544



526545



526546



526547



526549



526550



526551



526552



526554



526555



526556



526557



526558



526559



526560



526561



526562



526563



526564



526565



526566



526567



526568



526569



526570



526581



526583



526585



526587



526588



526589



526590



526591



526592



526594



526595



526593



SHAD

/ SACOCHE LATÉRALE

Description	Réf.
NOIR/MARRON 10 LITRES TYPE CAFE RACER	506225



SHAD

/ SACOCHE RESERVOIR

Description	Réf.
NOIR/MARRON 8 LITRES TYPE CAFE RACER	506224



/ SAC ETANCHE

Description	Réf.
20 LITRES- 500D TARPULIN PVC 24X24X45 - SUB20	508031

SHAD

/ TOP CASE



Description	Réf.
FEU STOP PLATINE TOP CASE SHAD 26L/29L/33L	494305

trendy

/ PROTECTION DORSALE



Description	Réf.
PROTECTION DORSALE BLOUSON TRENDY NIVEAU 1	505598

SHAD

/ SERRURE COMPLET TOP CASE SHAD



Description	Réf.
26L/29L	492552
33L/34L	503496

SHAD

/ SERRURE COMPLETE



Description	Réf.
POUR TOP CASE SHAD 39L	528806

SHAD

/ BARILLET



Description	Réf.
BARILLET + 2 CLES POUR TOP CASE JUSQU'A 46L	492553

Sélection **CGN**

/ SIÈGE ENFANT



Description	Réf.
SIÈGE ENFANT KAPPA ADAPT.SCOOTER/MOTO (ENFANT 5 à 8 ANS) AVEC SANGLES ET CROCHETS	481527

FULBAT®

BATTERIES PRÊTES À L'EMPLOI



LITHIUM | GEL

/ BATTERIES / BATTERIES

540

/ BOUGIES / SPARK PLUGS

652

/ ANTIPARASITES / SPARK PLUG CAPS

776



FULBAT

/ LA GAMME LITHIUM

La gamme Lithium est conçue pour offrir une expérience de conduite unique. Prête à l'emploi et ultra légère, cette gamme LiFeP04 garantit des et ultra légère, cette gamme LiFeP04 garantit des autodécharge très faible et une durée de vie extrême. Désormais équipée d'un BMS, cette gamme offre une sécurité renforcée. Idéale pour les pilotes les plus exigeants !

Réf	Désignation	Puissance (Wh)	Capacité (10Hr) Ah	Dimensions (±2mm)			Polarité	Courant de charge (A)	
				L	I	H		Std	Max
512625	FLTK01	24	2	86	48	90		1	4
520919	FLTX4L/5L - FLTZ5S/6S	25.6	2	113	70	85		1.0	2.0
503443	FLTX7L	30.7	2.4	113	70	85		1.2	4.8
520920	FLTX7L/S	38.4	3	113	70	105		1.5	3.0
520921	FLT7B/9B	51.2	4	150	65	93		2.0	4.0
520922	FLTZ10S	64	5	150	87	93		2.5	5.0
520923	FLT12B/14B	76.8	6	150	69	130		3	6
520925	FLTX20H	153.6	12	175	87	155		6.0	12.0
520924	FLTX20HL	153.6	12	175	87	155		6.0	12.0
520926	FLTX30HL	230.4	18	168	127	177		9.0	18.0

CARACTÉRISTIQUES





















- Prête à l'emploi & sans entretien.
- Poids ultra léger comparé aux batteries plomb.
- Haute performance de démarrage à froid.
- Conception fiable et sécurisée grâce au système BMS.
- Charge rapide (jusqu'à 5x plus rapide qu'une batterie plomb).
- Peut se monter dans toutes les positions.
- Testeur de batterie intégré avec écran LCD.
- Très faible autodécharge.
- Conforme à la nouvelle réglementation Européenne (UE) 2019/1148 de 2021 concernant la vente d'acide pour batteries.



/ BATTERIES GEL

La gamme de batteries GEL est conçue pour offrir des performances et une sécurité maximales ! Prête à l'emploi, la batterie GEL ne nécessite aucune manipulation d'acide, aucune préparation initiale ni aucun entretien. Sa conception 100% étanche (VRLA) associée à ses hautes performances en font la batterie idéale pour tous les sports motorisés.

6 V





Réf	Désignation	Capacité Ah (10h)	Capacité Ah (20h)	Dimensions (±2mm)			Polarité
				L	I	H	
517776	6N4-2A/A-4	4	4.2	71	71	93	
517777	6N6-3B/B-1	6	6.3	95	55	117	
517778	6N11A-1B/3A	11	11.6	121	58	130	
517779	6N11A-4A	11	11.6	121	58	130	
513061	FT4B-BS	2.3	2.4	113	38	85	
513062	FTR4A-BS	2.3	2.4	113	48	85	
511532	FB3L-A/B	3	3.2	98	56	110	
499699	FB4L-B	5	5.3	120	70	92	
511534	FB5L-B	5	5.3	120	60	130	
489939	FTX4L-BS/FTZ5S	5	5.3	113	70	85	
499703	FTX5L-BS/FTZ6S	5	5.3	113	70	105	
513055	12N5.5-3B	5.5	5.8	135	60	130	
513056	12N5.5-4A	5.5	5.8	135	60	130	
493802	FTZ7S	6	6.3	113	70	105	
499705	FTX7L-BS	6	6.3	113	70	130	
499704	FTX7A-BS	6	6.3	150	87	93	
491434	FT7B-4	6.5	6.8	150	65	93	
517317	FTZ7V	6.5	6.8	113	70	121	
500281	FTZ8V	7	7.4	113	70	130	
499706	FTX9-BS	8	8.4	150	87	105	
513058	FB7C-A	8	8.4	129	89	114	

Réf	Désignation	Capacité Ah (10h)	Capacité Ah (20h)	Dimensions (±2mm)			Polarité
				L	I	H	
513057	FB7-A	8	8.4	135	75	133	⊖ ⊖ ⊖ ⊖ ⊕
511535	FB7L-B/B2	8	8.4	136	76	130	⊖ ⊖ ⊖ ⊖ ⊕
490564	FT9B-4	8	8.4	150	68	105	⊖ ⊖ ⊖ ⊖ ⊕
490331	FTZ10S	8.6	9.1	150	88	93	⊖ ⊖ ⊖ ⊖ ⊕
499700	FB9-B (12N9-4B-1)	9	9.5	135	75	139	⊖ ⊖ ⊖ ⊖ ⊕
519520	FT12-10Z	10	10,5	194	59	112	⊖ ⊖ ⊖ ⊖ ⊕
517780	FT12A-BS	10	10.5	150	88	105	⊖ ⊖ ⊖ ⊖ ⊕
499707	FTX12-BS	10	10.5	150	87	130	⊖ ⊖ ⊖ ⊖ ⊕
493803	FT12B-4	10	10.5	150	69	130	⊖ ⊖ ⊖ ⊖ ⊕
511537	FB10L-A2/B2	11	11.6	133	90	145	⊖ ⊖ ⊖ ⊖ ⊕
490330	FTZ12S	11	11.6	150	88	110	⊖ ⊖ ⊖ ⊖ ⊕
490556	FTZ14S	11.2	11.8	150	88	110	⊖ ⊖ ⊖ ⊖ ⊕
511538	FB12A-A/B (12N12A-4A-1)	12	12.6	134	80	161	⊖ ⊖ ⊖ ⊖ ⊕
499701	FB12AL-A2	12	12.6	134	80	161	⊖ ⊖ ⊖ ⊖ ⊕
499708	FTX14-BS	12	12.6	150	87	145	⊖ ⊖ ⊖ ⊖ ⊕
517781	FTX14L-BS	12	12.6	150	87	145	⊖ ⊖ ⊖ ⊖ ⊕
493804	FT14B-4	12	12.6	150	69	145	⊖ ⊖ ⊖ ⊖ ⊕
511540	FTX14AH-BS/ FB 14-A2/B2 12N14-4A)	14	14.7	135	90	167	⊖ ⊖ ⊖ ⊖ ⊕
499702	FTX14AHL-BS/FB 14L-A2/ B2(12N14-3A)	14	14.7	135	90	167	⊖ ⊖ ⊖ ⊖ ⊕
513059	FB14A-A2	14	14.7	134	88	176	⊖ ⊖ ⊖ ⊖ ⊕
517782	FTX16	14	14.7	150	87	161	⊖ ⊖ ⊖ ⊖ ⊕
511541	FB16AL-A2	16	16.8	205	70	162	⊖ ⊖ ⊖ ⊖ ⊕
513063	FTX20-BS	18	18.9	175	87	155	⊖ ⊖ ⊖ ⊖ ⊕
513064	FTX20A-BS	18	18.9	150	57	161	⊖ ⊖ ⊖ ⊖ ⊕

Réf	Désignation	Capacité Ah (10h)	Capacité Ah (20h)	Dimensions (±2mm)			Polarité
				L	I	H	
499709	FTX20HL-BS	18	18.9	175	87	155	⊖ ⊕ ⊖ ⊕ ⊖ ⊕ ⊖ ⊕
513060	FB16CL-B	19	20	175	100	175	⊖ ⊕ ⊖ ⊕ ⊖ ⊕ ⊖ ⊕
511545	F50-N18L-A GEL (12N18-3A)	21	22,1	205	87	162	⊖ ⊕ ⊖ ⊕ ⊖ ⊕ ⊖ ⊕
513065	FTX24HL-BS/ F50-N18L-A/A2/ A3 (12N18-3A)	21	22.1	205	87	162	⊖ ⊕ ⊖ ⊕ ⊖ ⊕ ⊖ ⊕
513066	FIX30L-BS	30	31.6	165	125	175	⊖ ⊕ ⊖ ⊕ ⊖ ⊕ ⊖ ⊕
511544	53030 GEL (F60-N30L-A)	30	31.6	186	130	171	⊖ ⊕ ⊖ ⊕ ⊖ ⊕ ⊖ ⊕

BATTERIES GEL FITHD

La gamme GEL FitHD est composée des batteries renforcées de haute capacité conçues pour les Harley Davidson ainsi que pour les applications les plus exigeantes. Avec des bornes spécifiques et une coque renforcée, ces batteries offrent une résistance maximale aux vibrations.

Réf	Désignation	Capacité Ah (10h)	Capacité Ah (20h)	Dimensions (±2mm)			Polarité
				L	I	H	
504752	NH12-20 	20	21.1	186	82	171	⊖ ⊕ ⊖ ⊕ ⊖ ⊕ ⊖ ⊕
493807	FHD14HL-BS 	14	14.7	150	87	145	⊖ ⊕ ⊖ ⊕ ⊖ ⊕ ⊖ ⊕
493808	FHD20HL-BS 	20	21.1	175	87	155	⊖ ⊕ ⊖ ⊕ ⊖ ⊕ ⊖ ⊕
504080	FHD30HL-BS 	30	31.6	165	130	175	⊖ ⊕ ⊖ ⊕ ⊖ ⊕ ⊖ ⊕



/ BATTERIES MF

La gamme de batteries MF est conçue pour offrir davantage de confort et performances. Sans aucun entretien, la batterie MF est livrée avec un pack d'acide et nécessite d'être activée avant la première utilisation.

Sa conception de type VRLA lui permet de devenir étanche une fois activée ainsi que d'améliorer sa durée de vie et sa résistance aux conditions les plus exigeantes.

Réf	Désignation	Capacité Ah (10h)	Capacité Ah (20h)	Dimensions (±2mm)			Polarité
				L	I	H	
494764	FT4B-BS	2.3	2.4	113	38	85	⊖ ⊖ ⊖ ⊖
490563	FTR4A-BS	2.3	2.4	113	48	85	⊖ ⊖ ⊖ ⊖
489937	FTX4L-BS/ FTZ5S-BS	4	4.2	113	70	85	⊖ ⊖ ⊖ ⊖ ⊖
489944	FTX5L-BS	4	4.2	113	70	105	⊖ ⊖ ⊖ ⊖ ⊖
489947	FTX4L-BS	4	4.2	113	70	85	⊖ ⊖ ⊖ ⊖ ⊖
489942	FTX7L-BS	6	6.3	113	70	130	⊖ ⊖ ⊖ ⊖ ⊖
489941	FTX7A-BS	6	6.3	150	87	93	⊖ ⊖ ⊖ ⊖ ⊖
489940	FTX9-BS	8	8.4	150	87	105	⊖ ⊖ ⊖ ⊖ ⊖
490561	FT12A-BS	10	10.5	150	88	105	⊖ ⊖ ⊖ ⊖ ⊖
489943	FTX12-BS	10	10.5	150	87	130	⊖ ⊖ ⊖ ⊖ ⊖
489946	FTX14-BS	12	12.6	150	87	145	⊖ ⊖ ⊖ ⊖ ⊖
500866	FTX14L-BS	12	12.6	150	87	145	⊖ ⊖ ⊖ ⊖ ⊖
512637	FTX14AHL-BS	12	12.6	135	90	167	⊖ ⊖ ⊖ ⊖ ⊖
512638	FTX14AH-BS	12	12.6	135	90	167	⊖ ⊖ ⊖ ⊖ ⊖
524567	FB12A-A	12	12.6	134	80	160	⊖ ⊖ ⊖ ⊖ ⊖
524568	FB12A-B	12	12.6	134	80	160	⊖ ⊖ ⊖ ⊖ ⊖
490560	FTX16-BS	14	14.7	150	87	161	⊖ ⊖ ⊖ ⊖ ⊖
524569	FB14-A2	14	14.7	134	89	166	⊖ ⊖ ⊖ ⊖ ⊖
524570	FB14L-B2	14	14.7	134	89	166	⊖ ⊖ ⊖ ⊖ ⊖
500867	FTX20-BS	18	18.9	175	87	155	⊖ ⊖ ⊖ ⊖ ⊖



Réf	Désignation	Capacité Ah (10h)	Capacité Ah (20h)	Dimensions (±2mm)			Polarité
				L	I	H	
500868	FTX20A-BS	18	18.9	150	87	161	⊕ ⊖ ⊕ ⊖
489948	FTX20L-BS	18	18.9	175	87	155	⊖ ⊖ ⊖ ⊖ ⊕
504082	FTX24HL-BS	21	22.1	205	87	162	⊖ ⊖ ⊖ ⊖ ⊕
505706	FIX30L-BS	30	31.6	165	125	175	⊖ ⊖ ⊖ ⊖ ⊕

CARACTÉRISTIQUES

- ↗ Technologie AGM.
- ↗ Livrée avec un pack d'acide.
- ↗ Doit être activée avant la première utilisation.
- ↗ Aucun entretien une fois activée.
- ↗ Durée de vie plus longue.
- ↗ Montage vertical uniquement.
- ↗ Sulfatation interne minimisée.
- ↗ Adaptée par temps froid.
- ↗ Durée de stockage illimitée.
- ↗ 12 Volts.



**100 ANS de qualité,
de fiabilité et de performance
pour tous types de véhicules**

**YUASA
BATTERY**
by 

**OFFICIAL
SPONSOR**



 **JAPANESE
MANUFACTURER**
FOR OVER 100 YEARS

 **GS YUASA** Creating the Future of Energy

**Leader mondial des
fabricants de batteries**

MOTEUR

CYCLE

PNEUMATIQUE

ATELIER

ACCESSOIRES

ÉLECTRICITÉ

FILTRATION

FREINAGE

TRANSMISSION



Modèle	Cylindre	Année	FULBAT	FULBAT	YUASA		Réf.
			Préconisation constructeur	Sans entretien acide	Sans entretien gel	Lithium	
AJP							
SPR 125 Enduro SPR	125	2019 - 2023	493802			520919	483662
SPR 240 Enduro SPR	240	2019 - 2023	493802			520919	483662
AJS							
Custom JS 1256C	125	2012 - 2015	489938	526367	499700		462573
ECO JS 125E	125	2007 - 2009	489935		511534	520919	462568
ECO-2 JS 125E	125	2009 - 2015	489935		511534	520919	462568
Regal Raptor CR3 125	125	2006 - 2006	489941		499704	520922	465834
Regal Raptor DD 125E	125	2004 - 2015	489938	526367	499700		462573
Sport R7 125	125	2014 - 2015	489938	526367	499700		462573
Regal Raptor DD 250E	250	2004 - 2009	489938	526367	499700		462573
APRILIA							
Atlantic 125	125	2003 - 2012	491025		499701		462574
Atlantic 125	125	2007 - 2013	489940		499706	520922	465836
Classic 125	125	1995 - 2001	489938	526367	499700		462573
ETX 125	125	1999 - 2002	489949 489936		499699	520919	462567 483973 510611 512772
Europa AF1 125	125	1990 - 1994	489938	526367	499700		462573
Futura AF1 125	125	1987 - 1989	489938	526367	499700		462573
GP Replica RS4 125	125	2018 - 2020	489942		499705	520919	465840
Habana 125	125	2000 - 2002	489940		499706	520922	465836
Leonardo 125	125	1999 - 2001	491025		499701		462574
Leonardo 125ST	125	2003 - 2004	491025		499701		462574
Leonardo 125ST	125	2002 - 2002	489940		499706	520922	465836
Leonardo SR 125	125	1996 - 1998	491025		499701		462574
Max SR 125	125	2011 - 2016	489946		499708	520922	465838
Mojito 125	125	2003 - 2012	489942		499705	520919	465840
Mojito Custom 125	125	2003 - 2012	489942		499705	520919	465840
Mojito E3 125	125	2008 - 2008	489942		499705	520919	465840
Motard SR 125	125	2012 - 2016	489938	526367	499700		462573
MX 125	125	2003 - 2007	489949 489936		499699	520919	462567 483973 510611 512772
New Driven Shaft RS4 125	125	2011 - 2013	489942		499705	520919	465840
Old Driven Shaft RS4 125	125	2011 - 2013	489942		499705	520919	465840
Pegaso 125	125	1989 - 1996	489938	526367	499700		462573
Red Rose 125	125	1988 - 1995	489938	526367	499700		462573
Replica AF1 125	125	1987 - 1988	489938	526367	499700		462573
RS 125	125	1992 - 2012	489938	526367	499700		462573
RS 125	125	2021 - 2023	489943		499707	520922	465837
RS4 125	125	2014 - 2020	489942		499705	520919	465840

Modèle	Cylindre	Année	FULBAT		FULBAT		Lithium	Réf.
			Préconisation constructeur	Sans entretien acide	Sans entretien gel			
RX 125	125	2000 - 2012	489949 489936		499699	520919	462567 483973 510611 512772	
RX 125	125	2021 - 2023	489942		499705	520919	465840	
RX 125E	125	1993 - 1999	489949 489936		499699	520919	462567 483973 510611 512772	
RX 125IE	125	2018 - 2020	489942		499705	520919	465840	
RX 125R	125	1992 - 1995	489949 489936		499699	520919	462567 483973 510611 512772	
Scarabeo 125	125	1999 - 2006	491025		499701		462574	
Scarabeo 125GT	125	2004 - 2006	491025		499701		462574	
Scarabeo Light	125	2008 - 2010	489943		499707	520922	465837	
Scarabeo Light 125	125	2007 - 2007	491025		499701		462574	
Scarabeo Light 125IE	125	2009 - 2012	489943		499707	520922	465837	
Sport AF1 125	125	1989 - 1990	489938	526367	499700		462573	
Sport City	125	2004 - 2008	489943		499707	520922	465837	
Sport City Cube	125	2008 - 2012	489943		499707	520922	465837	
Sport City One 125	125	2008 - 2012	489938	526367	499700		462573	
Sport Pro F40 AF1 125	125	1992 - 1993	489938	526367	499700		462573	
SR 125	125	1999 - 2002	489942		499705	520919	465840	
SR GT	125	2023 -	489942		499705	520919	465840	
SRX	125	2023 -	489942		499705	520919	465840	
SX 125	125	2008 - 2013	489949 489936		499699	520919	462567 483973 510611 512772	
SX 125	125	2021 - 2023	489942		499705	520919	465840	
SX 125IE	125	2018 - 2020	489942		499705	520919	465840	
Tuareg 125	125	1985 - 1987	493810		513055			
Tuareg 125	125	1988 - 1988	489938	526367	499700		462573	
Tuareg Rally 125	125	1989 - 1994	489938	526367	499700		462573	
Tuareg Wind 125	125	1988 - 1991	489938	526367	499700		462573	
Tuono 125	125	2003 - 2007	489938	526367	499700		462573	
Tuono 125 4T E4	125	2017 - 2020	489942		499705	520919	465840	
Tuono 125 4T E5	125	2021 - 2023	489943		499707	520922	465837	
Leonardo 150	150	1999 - 2001	491025		499701		462574	
Leonardo 150ST	150	2002 - 2002	491025		499701		462574	
Leonardo 150ST	150	2003 - 2004	489940		499706	520922	465836	
Leonardo SR 150	150	1996 - 1998	491025		499701		462574	
Mojito 150	150	2003 - 2007	489942		499705	520919	465840	
Scarabeo 150	150	1999 - 2004	491025		499701		462574	
Scarabeo 150GT	150	2004 - 2006	491025		499701		462574	
SR 150	150	1999 - 2002	489942		499705	520919	465840	



Modèle	Cylindre	Année	FULBAT	FULBAT	Lithium	Réf.
			Préconisation constructeur	Sans entretien acide		
Atlantic 200 (4T)	200	2003 - 2005	491025		499701	462574
Scarabeo 200	200	1999 - 2006	491025		499701	462574
Scarabeo Light	200	2007 - 2010	489943		499707	520922
Scarabeo Light 200IE	200	2009 - 2010	489943		499707	520922
Sport City	200	2004 - 2005			493803	520923
Sport City	200	2006 - 2008	489943		499707	520922
Sport City Cube	200	2008 - 2009			493803	520923
Atlantic 250	250	2003 - 2005	491025		499701	462574
Atlantic 250ie	250	2006 - 2008	491025		499701	462574
Leonardo SR 250	250	2000 - 2004	491025		499701	462574
RS 250	250	1995 - 2003	489949 489936		499699	520919
Scarabeo 250	250	2004 - 2006	491025		499701	462574
Scarabeo Light E3	250	2006 - 2010	489943		499707	520922
Sport City 250ie	250	2006 - 2008	489943		499707	520922
Sport City Cube	250	2008 - 2010	489943		499707	520922
Atlantic 300	300	2010 - 2011	491025		499701	462574
Leonardo 300	300	2002 - 2004	491025		499701	462574
Max SR	300	2011 - 2016	489943		499707	520922
Scarabeo Light E3	300	2009 - 2011	489943		499707	520922
Sport City Cube	300	2008 - 2012	489943		499707	520922
Sport Cube	300	2011 - 2011	489943		499707	520922
Tuareg ETX 350	350	1985 - 1987	490558	512637	499702	465842
Tuareg Wind ETX 350	350	1988 - 1989	489938	526367	499700	462573
Atlantic 400 Sprint	400	2005 - 2008	489943		499707	520922
Scarabeo Light 400	400	2006 - 2010	489943		499707	520922
RXV 450	450	2006 - 2013	489941		499704	520922
Supermoto SXV 450	450	2006 - 2013	489941		499704	520922
Atlantic 500	500	2001 - 2004	490558	512637	499702	465842
Atlantic Sprint 500	500	2005 - 2010	489943		499707	520922
Scarabeo 500	500	2003 - 2006	490558	512637	499702	465842
Scarabeo 500ie	500	2007 - 2012	489943		499707	520922
Scarabeo Light 500	500	2006 - 2006	489943		499707	520922
RXV 550	550	2006 - 2013	489941		499704	520922
Supermoto SXV 550	550	2006 - 2013	489941		499704	520922
Pegaso 600	600	1990 - 1992	490558	512637	499702	465842
Tuareg ETX 600	600	1985 - 1987	490558	512637	499702	465842
Tuareg Wind 600	600	1987 - 1991	490558	512637	499702	465842
Moto 6.5 6,5	650	1995 - 2001	491025		499701	462574
Pegaso 650	650	1993 - 1996	490558	512637	499702	465842
Pegaso 650ie	650	2001 - 2004	491025		499701	462574
Pegaso Factory 650ie	650	2006 - 2010	489943		499707	520922
Pegaso III 650	650	1997 - 2001	491025		499701	462574
Pegaso Strada 650ie	650	2005 - 2010	489943		499707	520922

MOTEUR

CYCLE

PNEUMATIQUE

ATELIER

ACCESSOIRES

ÉLECTRICITÉ

FILTRATION

FREINAGE

TRANSMISSION

Modèle	Cylindre	Année	FULBAT		FULBAT		YUASA
			Préconisation constructeur	Sans entretien acide	Sans entretien gel	Lithium	Réf.
Pegaso Trail 650ie	650	2006 - 2008	489943		499707	520922	465837
Dorsoduro 750	750	2008 - 2016	489946		499708	520922	465838
Dorsoduro Factory 750	750	2010 - 2013	489943		499707	520922	465837
Shiver 750GT	750	2010 - 2013	489943		499707	520922	465837
Shiver 750GT	750	2009 - 2009	489946		499708	520922	465838
Shiver 750RA	750	2010 - 2010	489943		499707	520922	465837
Shiver 750RA	750	2007 - 2009	489946		499708	520922	465838
Shiver 750RAE	750	2010 - 2016	489943		499707	520922	465837
Mana GT NA 850	850	2009 - 2013	489946		499708	520922	465838
Mana NA 850	850	2007 - 2013	489946		499708	520922	465838
SRV 850	850	2012 - 2014	489946		499708	520922	465838
Dorsoduro 900	900	2017 - 2020	489943		499707	520922	465837
Shiver 900	900	2017 - 2020	489943		499707	520922	465837
Caponord ETV 1000	1000	2001 - 2008	489946		499708	520922	465838
Caponord Rally ETV 1000	1000	2001 - 2009	489946		499708	520922	465838
Factory RSV 1000R	1000	2004 - 2008	489943		499707	520922	465837
Factory RSV4 1000	1000	2009 - 2010	489943		499707	520922	465837
Factory RSV4 1000APRC SE	1000	2011 - 2014	490561		517780	520922	472408 481623
Falco SL 1000	1000	1999 - 2004	489946		499708	520922	465838
Futura RST 1000	1000	2001 - 2004	489943		499707	520922	465837
Racing Factory RSV 1000R	1000	2004 - 2008	489943		499707	520922	465837
Racing Factory RSV4 1000RF	1000	2015 - 2018	490561		517780	520922	472408 481623
RSV 1000	1000	2000 - 2008	489943		499707	520922	465837
RSV 1000	1000	1998 - 1999	489946		499708	520922	465838
RSV 1000SP	1000	1999 - 2000	489943		499707	520922	465837
RSV4 1000APRC R	1000	2012 - 2014	490561		517780	520922	472408 481623
RSV4 1000R	1000	2010 - 2011	489943		499707	520922	465837
RSV4 1000RR	1000	2015 - 2020	490561		517780	520922	472408 481623
Tuono Factory RSV 1000R	1000	2006 - 2010	489943		499707	520922	465837
Tuono RSV 1000R	1000	2002 - 2010	489943		499707	520922	465837
Tuono RSV4 1000V4 APRC R	1000	2011 - 2014	490561		517780	520922	472408 481623
Tuono V4 1100 Factory	1100	2015 - 2020	490561		517780	520922	472408 481623
Tuono V4 1100RR	1100	2015 - 2021	490561		517780	520922	472408 481623
Caponord 1200	1200	2013 - 2016	489946		499708	520922	465838
Caponord Rally 1200	1200	2015 - 2019	489946		499708	520922	465838
Dorsoduro 1200	1200	2011 - 2014	489946		499708	520922	465838
ARCTIC CAT							
250	250	1999 - 2005	490558	512637	499702		465842
250DVX	250	2006 - 2008	489943		499707	520922	465837



Modèle	Cylindre	Année	FULBAT		YUASA		Réf.
			Préconisation constructeur	Sans entretien acide	Sans entretien gel	Lithium	
300	300	1998 - 2011	490558	512637	499702		465842
400	400	1998 - 2004	524569	512638	511540		
2-UP TRV 400	400	2009 - 2011	524569	512638	511540		
400DVX	400	2004 - 2008	489940		499706	520922	465836
Auto 400	400	2003 - 2008	524569	512638	511540		
Manual 400	400	2005 - 2008	524569	512638	511540		
500	500	1998 - 2004	524569	512638	511540		
Auto 500	500	2000 - 2009	524569	512638	511540		
Manual 500	500	2005 - 2009	524569	512638	511540		
650HI	650	2011 - 2011	524569	512638	511540		
Auto 650HI TBX	650	2009 - 2011	524569	512638	511540		
Auto 650HI TRV	650	2009 - 2009	524569	512638	511540		
Mudpro 650HI	650	2010 - 2011	524569	512638	511540		
Prowler XT 650HI	650	2005 - 2010	524569	512638	511540		
TRV 700HI Efi	700	2009 - 2009	524569	512638	511540		
BAROSSA							
Baja 170	170	2003 - 2004	489941		499704	520922	465834
Cheetah 170	170	2003 - 2006	489941		499704	520922	465834
Magna 170	170	2003 - 2005	489941		499704	520922	465834
Puma Inverse 250	250	2006 - 2007	489940		499706	520922	465836
Quarterback 250	250	2005 - 2005	489941		499704	520922	465834
Quarterback Inverse 250	250	2006 - 2006	489941		499704	520922	465834
Silverhawk Inverse 250	250	2006 - 2007	489940		499706	520922	465836
BENELLI							
Adiva 125	125	2000 - 2004	489946		499708	520922	465838
BN 125	125	2018 - 2022	489941		499704	520922	465834
Caffe Nero 125	125	2011 - 2016	489942		499705	520919	465840
Jarno 125	125	1989 - 1989	500869				
Leoncino 150	125	2021 - 2022	489942		499705	520919	465840
Tornado Naked T TNT 125	125	2017 - 2022	489941		499704	520922	465834
TRK 125	125	2018 - 2020	489940		499706	520922	465836
Velvet 125	125	1999 - 2007	489940		499706	520922	465836
Adiva 150	150	2000 - 2004	489946		499708	520922	465838
Caffe Nero 150	150	2011 - 2016	489942		499705	520919	465840
Velvet 150	150	1999 - 2003	489940		499706	520922	465836
BN 251	250	2014 - 2018	489942		499705	520919	465840
Caffe Nero 250	250	2008 - 2014	489940		499706	520922	465836
Leoncino 250	250	2018 - 2020	489942		499705	520919	465840
Velvet 250	250	1999 - 2007	489943		499707	520922	465837
254	254	1983 - 1983	489938	526367	499700		462573
BN 302	300	2015 - 2018	489940		499706	520922	465836
BN 302R	300	2017 - 2020	489940		499706	520922	465836
BN 302S	300	2018 - 2020	489940		499706	520922	465836
Zenzero 350	350	2012 - 2017	489943		499707	520922	465837

Modèle	Cylindre	Année	FULBAT		FULBAT		Lithium	Réf.
			Préconisation constructeur	Sans entretien acide	Sans entretien gel			
354	354	1982 - 1982	490558	512637	499702		465842	
Sport 2 354	354	1983 - 1983	490558	512637	499702		465842	
Imperiale 400	400	2019 - 2022	489940		499706	520922	465836	
5004	500	1976 - 1976	490558	512637	499702		465842	
502C	500	2021 - 2022	489940		499706	520922	465836	
Leoncino 500	500	2017 - 2022	489940		499706	520922	465836	
Leoncino Trail 500	500	2017 - 2022	489940		499706	520922	465836	
TRK 502	500	2017 - 2022	489940		499706	520922	465836	
TRK 502X	500	2018 - 2022	489940		499706	520922	465836	
BN 600GT	600	2014 - 2017	489940		499706	520922	465836	
BN 600i	600	2014 - 2017	489940		499706	520922	465836	
BN 600R	600	2014 - 2016	489940		499706	520922	465836	
BN 600S	600	2014 - 2015	489940		499706	520922	465836	
Sport 654	654	1983 - 1983	490558	512637	499702		465842	
Sei 750	750	1975 - 1975	490558	512637	499702		465842	
752 S	752	2019 - 2021	489940		499706	520922	465836	
TRK 800	800	2022 - 2023	489940		499706	520922	465836	
Cafe Racer TNT 899	899	2008 - 2012	490556			520922	490512	
Century Racer TNT 899	899	2011 - 2012	490556			520922	490512	
TNT 899	899	2013 - 2016	490556			520922	490512	
TNT 899S	899	2007 - 2011	490556			520922	490512	
Tornado TNT 899	899	2007 - 2016	490556			520922	490512	
TRE-K 899	899	2007 - 2016	490556			520922	490512	
SEI 900	900	1983 - 1983	493814		511544	520926		
Tornado TRE 900	900	2002 - 2006	493803			520923	510622	
Amazonas TRE-K 1130	1130	2007 - 2015	490556			520922	490512	
Cafe Racer TNT 1130	1130	2005 - 2012	490556			520922	490512	
Century Racer TNT 1130	1130	2011 - 2011	490556			520922	490512	
Sport TNT 1130	1130	2004 - 2009	490556			520922	490512	
Titanium TNT 1130	1130	2005 - 2006	490556			520922	490512	
Tornado Naked Tre TNT 1130R	1130	2013 - 2016	490556			520922	490512	
Tornado R 160 TNT 1130R	1130	2009 - 2012	490556			520922	490512	
Tornado TNT 1130	1130	2006 - 2014	490556			520922	490512	
Tornado TRE 1130	1130	2006 - 2010	490556			520922	490512	
Tornado TRE 1130TR	1130	2009 - 2010	490556			520922	490512	
TRE-K 1130	1130	2006 - 2017	490556			520922	490512	
BETA								
ALP 125 (4T)	125	2008 - 2015	489944		499703	520919	465835	
ALP 125 (4T)	125	2003 - 2007	489942		499705	520919	465840	
Eikon 125	125	2000 - 2006	489940		499706	520922	465836	
Enduro RE 125 (4T)	125	2009 - 2016	489944		499703	520919	465835	
Enduro RR 125	125	2009 - 2020	489944		499703	520919	465835	
Motard RR 125	125	2008 - 2020	489944		499703	520919	465835	
Urban 125	125	2008 - 2015	489944		499703	520919	465835	



Modèle	Cylindre	Année	FULBAT		FULBAT		YUASA
			Préconisation constructeur	Sans entretien acide	Sans entretien gel	Lithium	Réf.
Urban Special 125	125	2009 - 2015	489944		499703	520919	465835
Eikon 150	150	2000 - 2006	489940		499706	520922	465836
ALP 200 (4T)	200	2008 - 2018	489944		499703	520919	465835
ALP 200 (4T)	200	2003 - 2007	489942		499705	520919	465840
Urban 200	200	2008 - 2015	489944		499703	520919	465835
Urban Special 200	200	2009 - 2015	489944		499703	520919	465835
EnduroRacing RR 250 (2T)	250	2013 - 2016	489944		499703	520919	465835
Enduro RR 250 (4T)	250	2005 - 2009	489944		499703	520919	465835
X-Trainer 250 (2T)	250	2019 - 2020	489944		499703	520919	465835
EnduroRacing RR 300 (2T)	300	2013 - 2016	489944		499703	520919	465835
X-Trainer 300 (2T)	300	2015 - 2020	489944		499703	520919	465835
ALP 4.0 (4T)	350	2005 - 2015	489942		499705	520919	465840
EnduroRacing RR 350	350	2013 - 2015	489944		499703	520919	465835
EnduroRacing RR 350EFI	350	2015 - 2017	489944		499703	520919	465835
Enduro RR 350	350	2011 - 2012	489944		499703	520919	465835
Motard M4 350	350	2007 - 2015	489942		499705	520919	465840
Supermotard M4 350	350	2004 - 2006	489942		499705	520919	465840
EnduroRacing RR 390EFI	390	2015 - 2017	489944		499703	520919	465835
Enduro RR 400	400	2005 - 2014	489944		499703	520919	465835
EnduroRacing RR 430	430	2015 - 2015	489944		499703	520919	465835
EnduroRacing RR 430EFI	430	2016 - 2017	489944		499703	520919	465835
Cross Country RR 450	450	2012 - 2012	489944		499703	520919	465835
EnduroRacing RR 450	450	2013 - 2014	489944		499703	520919	465835
Enduro RR 450	450	2005 - 2012	489944		499703	520919	465835
EnduroRacing RR 480EFI	480	2015 - 2017	489944		499703	520919	465835
Enduro RR 498	498	2012 - 2014	489944		499703	520919	465835
Enduro RR 520	520	2010 - 2012	489944		499703	520919	465835
Enduro RR 525	525	2005 - 2009	489944		499703	520919	465835
BMW							
Electric C Evolution	-	2014 - 2019	489940		499706	520922	465836
C1 125	125	1999 - 2003	490558	512637	499702		465842
C1 200	200	2001 - 2003	490558	512637	499702		465842
G 310GS	310	2016 - 2023	489940		499706	520922	465836
G 310GS	310	2021 - 2023	489940		499706	520922	465836
G 310R	310	2016 - 2020	489940		499706	520922	465836
G 310R	310	2021 - 2023	489940		499706	520922	465836
C 400GT	400	2018 - 2020	489940		499706	520922	465836
C 400X	400	2018 - 2020	489940		499706	520922	465836
G 450X	450	2008 - 2011	493802			520919	483662
R 45	450	1978 - 1985	512640		504752		
R 45N	450	1978 - 1985	512640		504752		
R 45T	450	1980 - 1985	512640		504752		
R 50 5	500	1969 - 1976			504752		
R 60 5	600	1969 - 1973			504752		

MOTEUR

CYCLE

PNEUMATIQUE

ATELIER

ACCESSOIRES

ÉLECTRICITÉ

FILTRATION

FREINAGE

TRANSMISSION

Modèle	Cylindre	Année	FULBAT	FULBAT	YUASA		Réf.
			Préconisation constructeur	Sans entretien acide	Sans entretien gel	Lithium	
R 60 6	600	1973 - 1976	493814		511544	520926	
R 60 7	600	1976 - 1980	493814		511544	520926	
R 60TIC	600	1978 - 1982	493814		511544	520926	
Sport Highline Scooter C 600	600	2013 - 2015	489946		499708	520922	465838
Sport Scooter C 600	600	2011 - 2020	489946		499708	520922	465838
30 Years GS F 650GS	650	2011 - 2011	489946		499708	520922	465838
30 Years GS F 650GS	650	2011 - 2011	489946		499708	520922	465838
Dakar F 650GS	650	1999 - 2007	491025		499701		462574
F 650GS	650	1999 - 2007	491025		499701		462574
F 650GS	650	2006 - 2012	489946		499708	520922	465838
Funduro F 650	650	1997 - 2003	491025		499701		462574
G 650GS	650	2008 - 2015	491025		499701		462574
Highline Scooter C 650GT	650	2013 - 2015	489946		499708	520922	465838
R 65	650	1988 - 1989	493814		511544	520926	
R 65GS	650	1987 - 1992	512640		504752		
R 65LS	650	1981 - 1985	512640		504752		
R 65RT	650	1985 - 1988	493814		511544	520926	
R 65T	650	1980 - 1985	512640		504752		
Scarver F 650CS	650	2000 - 2007	491025		499701		462574
Scooter C 650GT	650	2011 - 2020	489946		499708	520922	465838
Sertao G 650GS	650	2012 - 2014	491025		499701		462574
Sport C 650	650	2016 - 2020	489946		499708	520922	465838
Standard F 650	650	1993 - 1996	491025		499701		462574
Strada F 650ST	650	1997 - 2000	491025		499701		462574
Xchallenge G 650	650	2007 - 2009	490331			520922	483849
Xcountry G 650	650	2006 - 2009	490331			520922	483849
Xmoto G 650	650	2007 - 2009	490331			520922	483849
F 700GS	700	2011 - 2018	489946		499708	520922	465838
F 750GS	750	2017 - 2023	489943		499707	520922	465837
F 750GS 40th years GS edition F 750GS	750	2021 - 2023	489943		499707	520922	465837
K 75	750	1984 - 1995	493814		511544	520926	
K 752	750	1984 - 1996	493814		511544	520926	
K 75C	750	1985 - 1990	493814		511544	520926	
K 75RT	750	1989 - 1996	493814		511544	520926	
K 75S	750	1984 - 1996	493814		511544	520926	
R 75 5	750	1969 - 1973			504752		
R 75 6	750	1973 - 1976	493814		511544	520926	
R 75 7	750	1973 - 1979	493814		511544	520926	
30 Years GS F 800GS	800	2011 - 2011	489946		499708	520922	465838
Adventure F 800GS	800	2012 - 2018	489946		499708	520922	465838
F 650GS	800	2006 - 2012	489946		499708	520922	465838
F 800GS	800	2006 - 2018	489946		499708	520922	465838
F 800GT	800	2011 - 2020	489946		499708	520922	465838
F 800R	800	2005 - 2020	489946		499708	520922	465838
F 800R Chris Pfeiffer Edition	800	2009 - 2011	489946		499708	520922	465838



Modèle	Cylindre	Année	FULBAT		YUASA		Réf.
			Préconisation constructeur	Sans entretien acide	Sans entretien gel	Lithium	
F 800S	800	2004 - 2010	489946		499708	520922	465838
F 800ST	800	2004 - 2012	489946		499708	520922	465838
Mystic R 80	800	1994 - 1995	493814		511544	520926	
Paris Dakar CH R 80GS	800	1990 - 1995	493814		511544	520926	
R 80	800	1977 - 1995	493814		511544	520926	
R 80GS	800	1980 - 1987	512640		504752		
R 80GS	800	1987 - 1996	493814		511544	520926	
R 80R	800	1991 - 1994	493814		511544	520926	
R 80RT	800	1982 - 1995	493814		511544	520926	
R 80ST	800	1982 - 1984	512640		504752		
R 80TIC	800	1978 - 1985	493814		511544	520926	
Triple Black F 800GS	800	2012 - 2012	489946		499708	520922	465838
Trophy F 800GS	800	2012 - 2012	489946		499708	520922	465838
Adventure F 850GS	850	2017 - 2023	489943		499707	520922	465837
F 850GS	850	2017 - 2023	489943		499707	520922	465837
R 850C	850	1997 - 2000	512640		504752		
R 850GS	850	1996 - 2000	512640		504752		
R 850R	850	1994 - 2007	512640		504752		
R 850RT	850	1996 - 2006	512640		504752		
F 900R	900	2020 - 2023	499707		499707	520922	510619
F 900R FORCE	900	2021 - 2023	499707		499707	520922	510619
F 900XR	900	2020 - 2021	499707		499707	520922	510619
R 90 6	900	1973 - 1976	493814		511544	520926	
R 900RT	900	2005 - 2013	512640		504752		
R 90S	900	1973 - 1976	493814		511544	520926	
16 valve K 1	1000	1988 - 1993	493814		511544	520926	
16 valve K 100RS	1000	1989 - 1992	493814		511544	520926	
8 valve K 100RS	1000	1989 - 1989	493814		511544	520926	
Carbon S 1000RR HP4	1000	2013 - 2014	493802			520919	483662
K 100	1000	1982 - 1988	493814		511544	520926	
K 1002	1000	1987 - 1990	493814		511544	520926	
K 100LT	1000	1986 - 1991	493814		511544	520926	
K 100RS	1000	1983 - 1988	493814		511544	520926	
K 100RT	1000	1983 - 1989	493814		511544	520926	
Mystic R 100	1000	1993 - 1996	493814		511544	520926	
Optional Forged Wheels S 1000R	1000	2017 - 2020	489940		499706	520922	465836
Optional Forged Wheels S 1000RR	1000	2017 - 2018	489940		499706	520922	465836
Optional Forged Wheels S 1000RR	1000	2014 - 2016	490331			520922	483849
Optional Forged Wheels S 1000RR	1000	2014 - 2016	493802			520919	483662
Paris Dakar R 100GS	1000	1989 - 1996	493814		511544	520926	
R 100 7	1000	1976 - 1977	493814		511544	520926	
R 100 7T	1000	1977 - 1984	493814		511544	520926	
R 100GS	1000	1986 - 1994	493814		511544	520926	
R 100R	1000	1991 - 1995	493814		511544	520926	
R 100RS	1000	1976 - 1992	493814		511544	520926	

MOTEUR

CYCLE

PNEUMATIQUE

ATELIER

ACCESSOIRES

ÉLECTRICITÉ

FILTRATION

FREINAGE

TRANSMISSION

Modèle	Cylindre	Année	FULBAT	FULBAT	Lithium	Réf.	
			Préconisation constructeur	Sans entretien acide			Sans entretien gel
R 100RT	1000	1978 - 1995	493814		511544	520926	
R 100S	1000	1976 - 1980	493814		511544	520926	
S 1000R	1000	2013 - 2021	489940		499706	520922	465836
S 1000R	1000	2021 - 2023	489940		499706	520922	465836
S 1000R	1000	2022 - 2023	489940		499706	520922	465836
S 1000RR	1000	2017 - 2023	489940		499706	520922	465836
S 1000RR	1000	2009 - 2013	490331			520922	483849
S 1000RR	1000	2014 - 2016	493802			520919	483662
S 1000RR HP4	1000	2013 - 2014	490331			520922	483849
S 1000RR HP4	1000	2013 - 2014	493802			520919	483662
S 1000XR (with Keyless) S 1000XR	1000	2015 - 2023	499707		499707	520922	510619
S 1000XR (without Keyless) S 1000XR	1000	2015 - 2023	489940		499706	520922	465836
K 1100LT	1100	1989 - 1999	512640		504752		
K 1100RS	1100	1992 - 1996	512640		504752		
R 1100GS	1100	1993 - 1999	512640		504752		
R 1100R	1100	1993 - 2001	512640		504752		
R 1100RS	1100	1992 - 2001	512640		504752		
R 1100RT	1100	1994 - 2001	512640		504752		
R 1100S	1100	1996 - 2006	512640		504752		
Adventure R 1150GS	1150	2001 - 2006	512640		504752		
Evo R 1150GS	1150	2001 - 2003	512640		504752		
R 1150GS	1150	1998 - 2001	512640		504752		
R 1150R	1150	1999 - 2006	512640		504752		
R 1150RS	1150	2001 - 2004	512640		504752		
R 1150RT	1150	2000 - 2006	512640		504752		
Rockster Edition 80 R 1150R	1150	2004 - 2004	512640		504752		
Rockster R 1150R	1150	2003 - 2006	512640		504752		
Caf, Racer R NineT	1170	2019 - 2020	489946		499708	520922	465838
Enduro HP2 1170	1170	2005 - 2006	489946		499708	520922	465838
Megamoto HP2 1170	1170	2007 - 2008	489946		499708	520922	465838
Pure R NineT	1170	2017 - 2023	489946		499708	520922	465838
R NineT	1170	2013 - 2023	489946		499708	520922	465838
R NineT Urban GS 40th years GS edition R NineT	1170	2021 - 2023	489946		499708	520922	465838
Racer R NineT	1170	2017 - 2018	489946		499708	520922	465838
Scrambler R NineT	1170	2016 - 2023	489946		499708	520922	465838
Sport HP2 1170	1170	2008 - 2011	489946		499708	520922	465838
Urban R NineT	1170	2017 - 2023	489946		499708	520922	465838
Adventure M R 1200GS	1200	2006 - 2009	489946		499708	520922	465838
Adventure R 1200GS	1200	2005 - 2018	489946		499708	520922	465838
Adventure Triple Black R 1200GS	1200	2012 - 2012	489946		499708	520922	465838
Classic R 1200C	1200	2003 - 2004	512640		504752		
Independent R 1200C	1200	2000 - 2004	512640		504752		
K 1200GT	1200	2003 - 2008	512640		504752		
K 1200LT	1200	1997 - 2009	512640		504752		



Modèle	Cylindre	Année	FULBAT		FULBAT		YUASA
			Préconisation constructeur	Sans entretien acide	Sans entretien gel	Lithium	Réf.
K 1200R	1200	2005 - 2010	489946		499708	520922	465838
K 1200RS	1200	1996 - 2004	512640		504752		
K 1200S	1200	2003 - 2008	489946		499708	520922	465838
Montauk R 1200C	1200	2004 - 2004	512640		504752		
R 1200C	1200	1996 - 2002	512640		504752		
R 1200CL	1200	2002 - 2004	512640		504752		
R 1200GS	1200	2002 - 2018	489946		499708	520922	465838
R 1200R	1200	2006 - 2018	489946		499708	520922	465838
R 1200RS	1200	2015 - 2018	489946		499708	520922	465838
R 1200RT	1200	2005 - 2014	512640		504752		
R 1200RT	1200	2014 - 2018	517782				510624
R 1200RT-SE	1200	2010 - 2013	512640		504752		
R 1200S	1200	2005 - 2008	489946		499708	520922	465838
R 1200ST	1200	2003 - 2008	489946		499708	520922	465838
Rallye R 1200GS	1200	2012 - 2012	489946		499708	520922	465838
Sport K 1200R	1200	2005 - 2007	489946		499708	520922	465838
Triple Black R 1200GS	1200	2011 - 2013	489946		499708	520922	465838
Exclusive R 1250GS	1250	2019 - 2020	520922				
Exclusive TE R 1250GS	1250	2020 - 2020	520922				
R 1250 GS 40th years GS edition R 1250GS	1250	2021 - 2023	520922				
R 1250 GS Adventure 40th years GS edition R 1250GS	1250	2021 - 2023	520922				
R 1250 GS Adventure R 1250GS	1250	2019 - 2021	520922				
R 1250GS	1250	2019 - 2023	520922				
R 1250R	1250	2019 - 2023	520922				
R 1250RS	1250	2019 - 2023	489946		499708	520922	465838
R 1250RT	1250	2019 - 2023	517782				510624
R 1250RT LE R 1250RT	1250	2020 - 2023	517782				510624
R 1250RT SE R 1250RT	1250	2020 - 2023	517782				510624
Rallye R 1250GS	1250	2019 - 2020	520922				
Rallye TE R 1250GS	1250	2020 - 2020	520922				
TE R 1250GS	1250	2020 - 2020	520922				
Carbon K 1300R	1300	2012 - 2012	489946		499708	520922	465838
Dynamic K 1300R	1300	2011 - 2016	489946		499708	520922	465838
K 1300GT	1300	2009 - 2011	512640		504752		
K 1300GT EE	1300	2010 - 2011	512640		504752		
K 1300GT SE	1300	2010 - 2011	512640		504752		
K 1300R	1300	2007 - 2012	489946		499708	520922	465838
K 1300S	1300	2007 - 2016	489946		499708	520922	465838
Bagger K 1600B	1600	2017 - 2021	517782				510624
Exclusive K 1600GTL	1600	2013 - 2016	512640		504752		
Grand America K 1600B	1600	2018 - 2021	517782				510624
K 1600GT	1600	2011 - 2016	512640		504752		
K 1600GT	1600	2017 - 2021	517782				510624
K 1600GTL	1600	2011 - 2021	512640		504752		

MOTEUR

CYCLE

PNEUMATIQUE

ATELIER

ACCESSOIRES

ÉLECTRICITÉ

FILTRATION

FREINAGE

TRANSMISSION

Modèle	Cylindre	Année	FULBAT	FULBAT	YUASA		Réf.
			Préconisation constructeur	Sans entretien acide	Sans entretien gel	Lithium	
K 1600GTLE	1600	2012 - 2013	512640		504752		
K 1600GTSE	1600	2012 - 2015	512640		504752		
R 18 (Classic, B, Transcontinental)	1800	2020 - 2023	504080			520926	
BUELL							
Blast 492	492	2000 - 2007	489946		499708	520922	465838
Firebolt XB 9R	984	2002 - 2007	489946		499708	520922	465838
Lightning City X XB 9SX	984	2005 - 2010	489946		499708	520922	465838
Lightning XB 9S	984	2003 - 2004	489946		499708	520922	465838
1125CR	1125	2009 - 2010	493807				
1125R	1125	2008 - 2010	500866		517781		
Cyclone M2 1200	1200	1994 - 2002	489948		499709	520924	
Firebolt XB 12R	1200	2004 - 2010	489946		499708	520922	465838
Lightning Long XB 12Ss	1200	2006 - 2010	489946		499708	520922	465838
Lightning S1 1200	1200	1994 - 2000	489946		499708	520922	465838
Lightning X1 1200	1200	1998 - 2005	489948		499709	520924	
Lightning XB 12S	1200	2004 - 2008	489946		499708	520922	465838
Lightning XB 12SCG	1200	2006 - 2010	489946		499708	520922	465838
Lightning XB 12STT	1200	2008 - 2008	489946		499708	520922	465838
Thunderbolt S2 1200	1200	1995 - 1996	500867		513063		
Thunderbolt S3 1200	1200	1997 - 2000	489948		499709	520924	
Ulysses XB 12X	1200	2006 - 2010	489946		499708	520922	465838
Ulysses XB 12XT	1200	2008 - 2010	489946		499708	520922	465838
Whitelighting S1 1200	1200	1998 - 2000	489948		499709	520924	
BULL							
HuntS 125	125	2017 - 2017	489940		499706	520922	465836
BULLIT							
Hero 125	125	2018 - 2020	526367		499700		
Hunt S 125	125	2017 - 2018	526367		499700		
Spirit 125	125	2017 - 2018	526367		499700		
CAGIVA							
125W8	125	1992 - 1996	489949 489936		499699	520919	462567 483973 510611 512772
SXT 125	125	1982 - 1982	493810		513055		
W8 125	125	1993 - 1998	489949 489936		499699	520919	462567 483973 510611 512772
Aletta Rossa WSXT 125	125	1983 - 1984	524567		511538		
Blues 125	125	1987 - 1995	524567		511538		
Cruiser 125	125	1987 - 1989	489938	526367	499700		462573
Freccia 125C10	125	1989 - 1989	489938	526367	499700		462573
Freccia 125C12	125	1989 - 1992	489938	526367	499700		462573



Modèle	Cylindre	Année	FULBAT		FULBAT		YUASA
			Préconisation constructeur	Sans entretien acide	Sans entretien gel	Lithium	Réf.
K7 125	125	1989 - 1992	489949 489936		499699	520919	462567 483973 510611 512772
Mito 125	125	1990 - 2010	489938	526367	499700		462573
Mito Evo 125	125	1992 - 2007	489938	526367	499700		462573
N90 125	125	1990 - 1992	489938	526367	499700		462573
Planet 125	125	1997 - 2003	489938	526367	499700		462573
Super City 125	125	1991 - 2000	489938	526367	499700		462573
Tamanaco 125	125	1988 - 1991	489938	526367	499700		462573
T4 E-R 350	350	1987 - 1992	489945		511532		465832
W12	350	1993 - 1996	490558	512637	499702		465842
Canyon 500	500	1991 - 2000	489946		499708	520922	465838
T4 E-R 500	500	1987 - 1990	490558	512637	499702		465842
Canyon 600	600	1996 - 1999	489946		499708	520922	465838
River 600	600	1996 - 1999	490558	512637	499702		465842
W16	600	1994 - 1997	490558	512637	499702		465842
W16 > 2G 100001	600	1994 - 1998	490558	512637	499702		465842
V-Raptor 650	650	2001 - 2007	489940		499706	520922	465836
CAN AM							
Spyder RS 990	990	2010 - 2011	504082		511545	520924	
Spyder RS 990S	990	2010 - 2011	504082		511545	520924	
Spyder RS 990SE5	990	2008 - 2009	504082		511545	520924	
Spyder RS 990SM5	990	2008 - 2009	504082		511545	520924	
CCM							
404DS	404	2003 - 2004	491434			520921	488128 510616
404E	404	2003 - 2004	491434			520921	488128 510616
Supermoto 404DS	404	2003 - 2009	491434			520921	488128 510616
Trail 404DS	404	2007 - 2009	491434			520921	488128 510616
Dual Sport - Trail 604E DS	604	1998 - 2003	489940		499706	520922	465836
Roadster 604RS	604	2000 - 2003	489940		499706	520922	465836
Supermoto 604E	604	1999 - 2003	489940		499706	520922	465836
644DS	644	2004 - 2004	489940		499706	520922	465836
R 30	644	2002 - 2004	489940		499706	520922	465836
Supermoto 644DS	644	2004 - 2004	489940		499706	520922	465836
CF MOTO							
NK300	300	2020 - 2023	489943		499707	520922	465837
400GT CF 400GT	400	2019 - 2023	489943		499707	520922	465837
400NK CF 400NK	400	2019 - 2023	489943		499707	520922	465837
650GT CF 650GT	650	2018 - 2023	489943		499707	520922	465837
650MT CF 650MT	650	2018 - 2021	489943		499707	520922	465837
650NK	650	2012 - 2013	489943		499707	520922	465837

MOTEUR

CYCLE

PNEUMATIQUE

ATELIER

ACCESSOIRES

ÉLECTRICITÉ

FILTRATION

FREINAGE

TRANSMISSION

Modèle	Cylindre	Année	FULBAT		FULBAT		YUASA
			Préconisation constructeur	Sans entretien acide	Sans entretien gel	Lithium	Réf.
650NK CF 650NK	650	2018 - 2021	489943		499707	520922	465837
650TK	650	2013 - 2015	489943		499707	520922	465837
650TR	650	2013 - 2014	489943		499707	520922	465837
700CL-X	700	2020 - 2021	490556			520922	490512
700CL-X Adventure	700	2023 -	490556			520922	490512
700CL-X Heritage	700	2023 -	490556			520922	490512
700CL-X Sport	700	2023 -	490556			520922	490512
700CL-X Sport Georide	700	2023 -	490556			520922	490512
700MT CF 800MT	800	2020 - 2021	490556			520922	490512
DAELIM							
Altino 125ES	125	2001 - 2004	489938	526367	499700		462573
Evolution VS 125	125	2000 - 2004	489938	526367	499700		462573
Freewing SQ 125S2	125	2007 - 2009	489943		499707	520922	465837
Roadsport VJF 125Fi	125	2008 - 2016	489943		499707	520922	465837
Roadwin R VJF 125Fi	125	2008 - 2012	489943		499707	520922	465837
Roadwin VJ 125	125	2004 - 2013	489943		499707	520922	465837
VC-S 125	125	1995 - 1997	489938	526367	499700		462573
VS 125	125	1998 - 1999	489938	526367	499700		462573
Roadsport VJF 250	250	2010 - 2013	489943		499707	520922	465837
SV 250S3	250	2012 - 2014	489943		499707	520922	465837
DERBI							
Cross City 125	125	2007 - 2013	489942		499705	520919	465840
GPR 1254V	125	2009 - 2016	489942		499705	520919	465840
Mulhacen 125	125	2007 - 2010	489942		499705	520919	465840
Mulhacen Cafe 125	125	2008 - 2011	489942		499705	520919	465840
Nude GPR 125	125	2004 - 2008	489944		499703	520919	465835
Racing GPI 125	125	2007 - 2009	489942		499705	520919	465840
Racing GPR 125	125	2004 - 2009	489944		499703	520919	465835
Rambla 125	125	2008 - 2012	489943		499707	520922	465837
Scooter GPI 125	125	2006 - 2006	489942		499705	520919	465840
Senda 125R	125	2004 - 2005	489942		499705	520919	465840
Senda 125SM	125	2004 - 2007	489944		499703	520919	465835
Senda Baja 125R	125	2006 - 2012	489942		499705	520919	465840
Senda Baja 125SM	125	2006 - 2012	489942		499705	520919	465840
Senda DRD 125R	125	2010 - 2013	489942		499705	520919	465840
Senda DRD 125SM	125	2009 - 2015	489942		499705	520919	465840
Sonar 125	125	2010 - 2011	489943		499707	520922	465837
Terra Adventure 125	125	2007 - 2014	489942		499705	520919	465840
Terra Euro 125	125	2007 - 2013	489942		499705	520919	465840
Variant Sport 125 (4T)	125	2012 - 2012	489938	526367	499700		462573
Sonar 150	150	2009 - 2010	489943		499707	520922	465837
Rambla 300i	300	2010 - 2012	489943		499707	520922	465837
DUCATI							
F3 350	350	1987 - 1988	490558	512637	499702		465842



Modèle	Cylindre	Année	FULBAT		YUASA		Réf.
			Préconisation constructeur	Sans entretien acide	Sans entretien gel	Lithium	
Indiana 350	350	1987 - 1988	490558	512637	499702		465842
Sport 350	350	1992 - 1992		504082	511545	520924	
SS 350	350	1993 - 1994			511541		
Monster 400	400	1995 - 1997			511541		
Monster 400	400	2000 - 2004	493803			520923	510622
Monster 400ie	400	2007 - 2008	493803			520923	510622
Monster Dark 400ie	400	2005 - 2006	493803			520923	510622
Scrambler Sixty 2 400	400	2017 - 2020			493803	520923	
Supersport 400	400	1993 - 1997			511541		
500GTL	500	1975 - 1975		504082	511545	520924	
Pantah 500	500	1979 - 1979	490558	512637	499702		465842
Pantah 500GTV	500	1977 - 1977		504082	511545	520924	
Sport Desmo 500	500	1977 - 1977		504082	511545	520924	
Monster 600	600	1993 - 1999			511541		
Monster 600	600	2000 - 2001	493803			520923	510622
Monster City (Dark) 600	600	1999 - 1999			511541		
Monster Dark 600	600	1998 - 1999			511541		
Pantah 600	600	1981 - 1982	490558	512637	499702		465842
Supersport 600	600	1994 - 1998			511541		
Monster 620	620	2005 - 2006	493803			520923	510622
Monster 620ie	620	2002 - 2004	493803			520923	510622
Monster Dark 620	620	2003 - 2004	493803			520923	510622
Multistrada 620	620	2005 - 2006	493803			520923	510622
Multistrada Dark 620	620	2005 - 2006	493803			520923	510622
Supersport 620S	620	2003 - 2003	493803			520923	510622
Indiana 650	650	1987 - 1988	490558	512637	499702		465842
Pantah 650	650	1984 - 1984	490558	512637	499702		465842
Monster 695	695	2006 - 2008	493803			520923	510622
Monster 696	696	2008 - 2014	493803			520923	510622
Monster 696+	696	2009 - 2012	493803			520923	510622
748R	748	2000 - 2002	493803			520923	510622
748SP	748	1995 - 1998			511541		
748SPS	748	1998 - 1999			511541		
Biposto 748	748	1995 - 2000			511541		
Biposto 748	748	2001 - 2002	493803			520923	510622
Biposto 748S	748	2000 - 2002	493803			520923	510622
Monoposto 748S	748	2000 - 2002	493803			520923	510622
Monoposto 748SP	748	1999 - 2000			511541		
Monoposto 748SP	748	2001 - 2002	493803			520923	510622
Testa Bassa 748	748	2001 - 2001	493803			520923	510622
749R	749	2004 - 2006	493803			520923	510622
749S	749	2003 - 2007	493803			520923	510622
Dark 749	749	2004 - 2006	493803			520923	510622
Monoposto Biposto 749	749	2003 - 2006	493803			520923	510622
750SS	750	1975 - 1976	524567		511538		

MOTEUR

CYCLE

PNEUMATIQUE

ATELIER

ACCESSOIRES

ÉLECTRICITÉ

FILTRATION

FREINAGE

TRANSMISSION

Modèle	Cylindre	Année	FULBAT		FULBAT		YUASA
			Préconisation constructeur	Sans entretien acide	Sans entretien gel	Lithium	Réf.
Desmo 750F1	750	1984 - 1987	490558	512637	499702		465842
Indiana 750	750	1987 - 1990	490558	512637	499702		465842
Monster (Dark) 750	750	1999 - 1999			511541		
Monster 750	750	1996 - 1998			511541		
Monster 750	750	2000 - 2002	493803			520923	510622
Monster 750ie	750	2002 - 2002	493803			520923	510622
Monster City (Dark) 750	750	1999 - 1999			511541		
Montjuich 750	750	1987 - 1987	490558	512637	499702		465842
Paso 750	750	1987 - 1988	490558	512637	499702		465842
Santamonica 750	750	1987 - 1988	490558	512637	499702		465842
Sport 750	750	1988 - 1990			511541		
Super Sport 750SS	750	1974 - 1974	524567		511538		
Supersport 750	750	1991 - 1999			511541		
Supersport 750IE	750	1999 - 1999			511541		
Supersport 750IE	750	2000 - 2002	493803			520923	510622
Supersport Sport 750	750	2001 - 2002	493803			520923	510622
Hypermotard 796	796	2010 - 2012	493803			520923	510622
Monster 796	796	2010 - 2014	493803			520923	510622
Monster 797	797	2017 - 2020			493803	520923	
Monster 797+	797	2018 - 2020			493803	520923	
Monster 800	800	2003 - 2004	493803			520923	510622
Monster 800S2R	800	2005 - 2007	493803			520923	510622
Monster Dark 800	800	2003 - 2003	493803			520923	510622
Monster Dark 800S2R	800	2005 - 2006	493803			520923	510622
Scrambler Caf, Racer 803	800	2017 - 2020			493803	520923	
Scrambler Classic 803	800	2015 - 2020			493803	520923	
Scrambler Desert Sled 803	800	2017 - 2021			493803	520923	
Scrambler Flat Track Pro 803	800	2016 - 2016			493803	520923	
Scrambler Full Throttle 803	800	2015 - 2023			493803	520923	
Scrambler Icon 803	800	2015 - 2023			493803	520923	
Scrambler Mach 2.0 803	800	2018 - 2018			493803	520923	
Scrambler Nightshift 803	800	2021 - 2023			493803	520923	
Scrambler Street Classic 803	800	2018 - 2018			493803	520923	
Scrambler Urban Enduro 803	800	2015 - 2016			493803	520923	
Supersport 800	800	2003 - 2005	493803			520923	510622
Supersport 800S	800	2003 - 2003	493803			520923	510622
Hypermotard 821	821	2013 - 2015	493803			520923	510622
Hypermotard 821SP	821	2013 - 2015	493803			520923	510622
Hyperstrada 821	821	2013 - 2015	493803			520923	510622
Monster 821	821	2015 - 2017	493803			520923	510622
Monster 821	821	2018 - 2020			493803	520923	
Monster Dark 821	821	2014 - 2017	493803			520923	510622
Monster Dark 821	821	2018 - 2018			493803	520923	
Monster Stealth 821	821	2019 - 2020			493803	520923	
Monster Stripe 821	821	2015 - 2016	493803			520923	510622



Modèle	Cylindre	Année	FULBAT		YUASA		
			Préconisation constructeur	Sans entretien acide	Sans entretien gel	Lithium	Réf.
Monster Stripe 821	821	2017 - 2018			493803	520923	
848	848	2008 - 2010	493803			520923	510622
Evo 848	848	2010 - 2013	493803			520923	510622
Evo Corse 848SE	848	2012 - 2013	493803			520923	510622
Evo Dark 848	848	2012 - 2012	493803			520923	510622
Streetfighter 848	848	2011 - 2015	493803			520923	510622
Sport 851	851	1988 - 1991			511541		
Strada 851	851	1992 - 1994			511541		
Superbike Biposto 85ISP1	851	1988 - 1989			511541		
Superbike Biposto 85ISP2	851	1990 - 1990			511541		
Superbike Biposto 85ISP3	851	1991 - 1991			511541		
Superbike Biposto 85ISP4	851	1992 - 1992			511541		
860GT GTS	860	1975 - 1976	493814		511544	520926	
Superbike Strada 888SP4	888	1992 - 1992			511541		
Superbike Strada 888SP5	888	1993 - 1995			511541		
Panigale 899	899	2014 - 2015			491434	520921	
900GTS	900	1975 - 1976	493814		511544	520926	
900SS	900	1975 - 1976	524567		511538		
Darmah 900SD	900	1977 - 1979	493814		511544	520926	
Evoluzione MH 900IE	900	2000 - 2001			511541		
Hailwood Replica 900	900	1979 - 1979	524567		511538		
Monster 900	900	1993 - 1999			511541		
Monster 900IE	900	2000 - 2000			511541		
Monster 900IE	900	2001 - 2002	493803			520923	510622
Monster City (Dark) 900	900	1999 - 1999			511541		
Monster Cromo 900	900	1998 - 1998			511541		
Monster Dark 900IE	900	2000 - 2000			511541		
Monster Dark 900IE	900	2001 - 2001	493803			520923	510622
Supersport 900	900	1989 - 1999			511541		
Supersport 900	900	2001 - 2002	493803			520923	510622
Supersport 900CR	900	1998 - 1998			511541		
Supersport 900FE	900	1998 - 1998			511541		
Supersport Sport 900	900	2002 - 2002	493803			520923	510622
Supersport Superlight 900	900	1991 - 1997			511541		
Paso 906	906	1988 - 1991	490558	512637	499702		465842
907IE	907	1990 - 1993					
916SP	916	1994 - 1998			511541		
916ST4	916	1999 - 2000			511541		
916ST4	916	2001 - 2002	493803			520923	510622
Biposto 916	916	1994 - 1998			511541		
Monster 916S4	916	2001 - 2003	493803			520923	510622
Monster Foggy 916S4	916	2002 - 2002	493803			520923	510622
Senna 916	916	1994 - 1996			511541		
Monster + 937	937	2023 -			491434	520921	
Monster 937	937	2021 - 2023			491434	520921	

Modèle	Cylindre	Année	FULBAT	FULBAT	YUASA		Réf.
			Préconisation constructeur	Sans entretien acide	Sans entretien gel	Lithium	
Monster SP 937	937	2023 -			491434	520921	
Multistrada V2 (Permis A2)	937	2022 - 2023	493803			520923	510622
Multistrada V2 S	937	2022 - 2023	493803			520923	510622
Multistrada V2 S Travel	937	2022 - 2023	493803			520923	510622
Hypermotard 939	939	2016 - 2020			493803	520923	
Hypermotard 939SP	939	2016 - 2018			493803	520923	
Hyperstrada 939	939	2016 - 2016			493803	520923	
Supersport 939	939	2017 - 2018	493803			520923	510622
Supersport 939	939	2019 - 2020			493803	520923	
Supersport 939S	939	2017 - 2018	493803			520923	510622
Supersport 939S	939	2019 - 2020			493803	520923	
944ST2	944	1997 - 2000			511541		
944ST2	944	2001 - 2003	493803			520923	510622
Hypermotard 950	950	2019 - 2023			493803	520923	
Hypermotard RVE 950	950	2019 - 2023			493803	520923	
Hypermotard SP 950	950	2019 - 2023			493803	520923	
Multistrada 950	950	2017 - 2021			493803	520923	
SuperSport 950	950	2021 - 2023			491434	520921	
SuperSport S 950	950	2021 - 2023			491434	520921	
Streetfighter 955 V2	955	2022 - 2023			491434	520921	
Panigale 959	959	2016 - 2017			491434	520921	
Panigale V2 959	959	2020 - 2023			491434	520921	
Panigale V2 Bayliss 959	959	2022 - 2023			491434	520921	
Desmosedici 989	989	2008 - 2008	493803			520923	510622
992ST3	992	2004 - 2007	493803			520923	510622
996R	996	2001 - 2001	493803			520923	510622
996S	996	2001 - 2001	493803			520923	510622
996SPS	996	1997 - 1999			511541		
996ST4S	996	2001 - 2005	493803			520923	510622
Monoposto Biposto 996	996	1999 - 2000			511541		
Monoposto Biposto 996	996	2001 - 2001	493803			520923	510622
Monster 996S4R	996	2003 - 2006	493803			520923	510622
998R	998	2002 - 2002	493803			520923	510622
998S	998	2002 - 2004	493803			520923	510622
Bayliss Bostrom 998S	998	2002 - 2002	493803			520923	510622
Matrix 998	998	2004 - 2004	493803			520923	510622
Monoposto Biposto 998	998	2002 - 2003	493803			520923	510622
Monster Testastretta 998S4R	998	2007 - 2008	493803			520923	510622
Monster Testastretta 998S4RS	998	2006 - 2008	493803			520923	510622
Monster Testastretta Tricolore 998S4RS	998	2008 - 2008	493803			520923	510622
999	999	2003 - 2006	493803			520923	510622
999R	999	2003 - 2006	493803			520923	510622
999S	999	2003 - 2004	493803			520923	510622
Fila 999R	999	2003 - 2003	493803			520923	510622
Monoposto Biposto 999S	999	2005 - 2006	493803			520923	510622



Modèle	Cylindre	Année	FULBAT		YUASA		
			Préconisation constructeur	Sans entretien acide	Sans entretien gel	Lithium	Réf.
Xerox 999R	999	2006 - 2006	493803			520923	510622
1000GT	1000	2006 - 2010	493803			520923	510622
Mike Hailwood Replica 1000RI	1000	1984 - 1984	493803			520923	510622
Monster 1000	1000	2003 - 2003	493803			520923	510622
Monster 1000ie	1000	2004 - 2005	493803			520923	510622
Monster 1000S ie	1000	2003 - 2005	493803			520923	510622
Monster 1000S2R	1000	2006 - 2008	493803			520923	510622
Multistrada 1000DS	1000	2003 - 2006	493803			520923	510622
Multistrada S 1000DS	1000	2005 - 2006	493803			520923	510622
Panigale V4 R 998	1000	2019 - 2023					
Panigale V4 Superleggera 998	1000	2023 -					
Paul Smart 1000LE	1000	2006 - 2008	493803			520923	510622
Sport 1000S	1000	2007 - 2009	493803			520923	510622
Sport Classic 1000	1000	2006 - 2008	493803			520923	510622
Supersport 1000DS	1000	2005 - 2006	493803			520923	510622
Supersport 1000SS	1000	2003 - 2004	493803			520923	510622
Touring 1000GT	1000	2009 - 2009	493803			520923	510622
1098	1098	2007 - 2008	493803			520923	510622
1098R	1098	2008 - 2009	493803			520923	510622
1098S	1098	2007 - 2008	493803			520923	510622
Bayliss 1098R	1098	2009 - 2009	493803			520923	510622
Tricolore 1098S	1098	2007 - 2007	493803			520923	510622
Evo Hypermotard 1100	1100	2010 - 2012	493803			520923	510622
Evo Hypermotard 1100SP	1100	2010 - 2012	493803			520923	510622
Hypermotard 1100	1100	2007 - 2009	493803			520923	510622
Hypermotard 1100S	1100	2007 - 2009	493803			520923	510622
Monster 1100	1100	2009 - 2010	493803			520923	510622
Monster 1100S	1100	2009 - 2010	493803			520923	510622
Monster Diesel 1100	1100	2013 - 2013	493803			520923	510622
Monster Evo 1100	1100	2011 - 2013	493803			520923	510622
Multistrada 1100	1100	2007 - 2009	493803			520923	510622
Multistrada 1100S	1100	2007 - 2009	493803			520923	510622
Panigale V4 1103	1100	2019 - 2023			491434	520921	
Panigale V4 S 1103	1100	2022 - 2023			491434	520921	
Panigale V4 SP2 1103	1100	2022 - 2023			491434	520921	
Scrambler 1100	1100	2018 - 2021			493803	520923	
Scrambler Dark Pro 1100	1100	2022 - 2023			493803	520923	
Scrambler Special 1100	1100	2018 - 2021			493803	520923	
Scrambler Sport 1100	1100	2019 - 2021			493803	520923	
Scrambler Sport Pro 1100	1100	2022 - 2023			493803	520923	
Scrambler Tribute Pro 1100	1100	2022 - 2023			493803	520923	
Streetfighter 1100	1100	2009 - 2010	493803			520923	510622
Streetfighter 1100S	1100	2009 - 2013	493803			520923	510622
Streetfighter V4 1103	1100	2020 - 2023			491434	520921	
Streetfighter V4 Lamborghini 1103	1100	2023 -			491434	520921	

MOTEUR

CYCLE

PNEUMATIQUE

ATELIER

ACCESSOIRES

ÉLECTRICITÉ

FILTRATION

FREINAGE

TRANSMISSION

Modèle	Cylindre	Année	FULBAT		YUASA		Réf.
			Préconisation constructeur	Sans entretien acide	Sans entretien gel	Lithium	
Streetfighter V4 S 1103	1100	2023 -			491434	520921	
Streetfighter V4 SP2 1103	1100	2023 -			491434	520921	
Diavel V4 1158	1158	2023 -			493803	520923	
Multistrada V4 1160	1160	2021 - 2023	493803			520923	510622
Multistrada V4 4Ever Ducati 1160	1160	2021 - 2023	493803			520923	510622
Multistrada V4 Pikes Peak 1160	1160	2021 - 2023	493803			520923	510622
Multistrada V4 Rally 1160	1160	2023 -	493803			520923	510622
Multistrada V4 S 1160	1160	2021 - 2023	493803			520923	510622
Multistrada V4 S Sport 1160	1160	2021 - 2023	493803			520923	510622
1198	1198	2009 - 2011	493803			520923	510622
1198S	1198	2009 - 2010	493803			520923	510622
1198SP	1198	2011 - 2011	493803			520923	510622
Corse 1198R	1198	2010 - 2010	493803			520923	510622
Corse 1198S	1198	2010 - 2010	493803			520923	510622
Panigale 1199	1199	2012 - 2014			491434	520921	
Panigale R 1199	1199	2013 - 2015			491434	520921	
Panigale S 1199	1199	2012 - 2014			491434	520921	
Panigale S Tricolore 1199	1199	2012 - 2014			491434	520921	
Diavel 1200	1200	2011 - 2016	493803			520923	510622
Diavel 1200	1200	2017 - 2018			493803	520923	
Diavel AMG 1200	1200	2012 - 2013	493803			520923	510622
Diavel Carbon 1200	1200	2011 - 2016	493803			520923	510622
Diavel Carbon 1200	1200	2017 - 2018			493803	520923	
Diavel Chromo 1200	1200	2012 - 2014	493803			520923	510622
Diavel Dark 1200	1200	2013 - 2014	493803			520923	510622
Diavel Diesel 1200	1200	2017 - 2018			493803	520923	
Diavel Strada 1200	1200	2013 - 2014	493803			520923	510622
Monster 1200	1200	2014 - 2020	493803			520923	510622
Monster 1200	1200	2017 - 2018			493803	520923	
Monster 1200R	1200	2019 - 2020	493803			520923	510622
Monster 1200R	1200	2016 - 2018			493803	520923	
Monster 1200S	1200	2014 - 2020	493803			520923	510622
Monster 1200S	1200	2017 - 2018			493803	520923	
Monster Stripe 1200S	1200	2015 - 2018	493803			520923	510622
Multistrada 1200	1200	2010 - 2014	493803			520923	510622
Multistrada 1200S	1200	2010 - 2012	493803			520923	510622
Multistrada D Air DVT 1200S	1200	2015 - 2017			493803	520923	
Multistrada DVT 1200	1200	2015 - 2017			493803	520923	
Multistrada DVT 1200S	1200	2015 - 2017			493803	520923	
Multistrada Enduro 1200	1200	2016 - 2018			493803	520923	
Multistrada Enduro Pro 1200	1200	2018 - 2018			493803	520923	
Multistrada Granturismo 1200S	1200	2013 - 2014	493803			520923	510622
Multistrada Pikes Peak 1200S	1200	2016 - 2016			493803	520923	
Multistrada Pikes Peak 1200SE	1200	2011 - 2014	493803			520923	510622
Multistrada Pikes Peak 1200SE	1200	2017 - 2017			493803	520923	



Modèle	Cylindre	Année	FULBAT		YUASA		Réf.
			Préconisation constructeur	Sans entretien acide	Sans entretien gel	Lithium	
Multistrada Sports Edition 1200S	1200	2010 - 2014	493803			520923	510622
Multistrada Touring Edition 1200	1200	2011 - 2012	493803			520923	510622
Multistrada Touring Edition 1200S	1200	2010 - 2014	493803			520923	510622
Diavel 1260	1260	2019 - 2021			493803	520923	
Diavel 1260 S Lamborghini 1260	1260	2021 - 2023			493803	520923	
Multistrada 1260	1260	2018 - 2021			493803	520923	
Multistrada 1260S	1260	2018 - 2020			493803	520923	
Multistrada D Air 1260S	1260	2018 - 2020			493803	520923	
Multistrada Enduro 1260	1260	2018 - 2021			493803	520923	
Multistrada Pikes Peak 1260S	1260	2018 - 2020			493803	520923	
Multistrada Touring 1260	1260	2018 - 2018			493803	520923	
XDiavel 1262	1262	2016 - 2021			493803	520923	
XDiavel Dark 1262	1262	2021 - 2023			493803	520923	
XDiavel Nera 1262	1262	2023 -			493803	520923	
XDiavel S 1262	1262	2016 - 2023			493803	520923	
XDiavel Star 1262	1262	2021 - 2022			493803	520923	
Panigale 1299	1299	2015 - 2017			491434	520921	
Panigale 1299S	1299	2015 - 2017			491434	520921	
Superleggera 1299	1299	2017 - 2017			491434	520921	
E-TON							
Challenger CXL 150	150	2002 - 2003	489940		499706	520922	465836
Yukon YXL 150	150	2000 - 2002	489940		499706	520922	465836
FANTIC							
XE 125	125	2020 - 2023	489937		489939	520919	465833
XEF 125 Competition	125	2021 - 2023	489937		489939	520919	465833
XEF 125 Performance	125	2021 - 2023	489937		489939	520919	465833
XMF 125 Competition	125	2021 - 2023	489937		489939	520919	465833
XMF 125 Performance	125	2021 - 2023	489937		489939	520919	465833
Caballero Anniversary 500	500	2020 - 2023	489940		499706	520922	465836
Caballero Deluxe 500	500	2020 - 2023	489940		499706	520922	465836
Caballero Explorer 500	500	2020 - 2023	489940		499706	520922	465836
Caballero Flat Track 500	500	2020 - 2023	489940		499706	520922	465836
Caballero Rally 500 500	500	2020 - 2023	489940		499706	520922	465836
Caballero Scrambler 500	500	2020 - 2023	489940		499706	520922	465836
GARELLI							
Tiger 125XLE	125	1986 - 1986	489938	526367	499700		462573
Tiger 125XR	125	1983 - 1983	489935		511534	520919	462568
GAS-GAS							
EC 200	200	2013 - 2017	493802			520919	483662
EC 200ER	200	2014 - 2017	493802			520919	483662
Cami EC 250F (4T)	250	2014 - 2015	493802			520919	483662
EC 250	250	2012 - 2017	493802			520919	483662
EC 250ER	250	2014 - 2017	493802			520919	483662
EC 250F (4T)	250	2010 - 2015	493802			520919	483662

MOTEUR

CYCLE

PNEUMATIQUE

ATELIER

ACCESSOIRES

ÉLECTRICITÉ

FILTRATION

FREINAGE

TRANSMISSION

Modèle	Cylindre	Année	FULBAT	FULBAT	Lithium	Réf.	
			Préconisation constructeur	Sans entretien acide			Sans entretien gel
Pampera 250	250	1996 - 2004	489937		489939	520919	465833
EC 300	300	2012 - 2015	493802			520919	483662
EC 300ER	300	2014 - 2017	493802			520919	483662
EC 300F (4T)	300	2013 - 2015	493802			520919	483662
Pampera 370	370	1996 - 1997	489937		489939	520919	465833
EC 400FSE	400	2002 - 2002	493802			520919	483662
SM 400FSE	400	2001 - 2002	493802			520919	483662
EC 450F (4T)	450	2013 - 2015	493802			520919	483662
EC 450FSR	450	2005 - 2009	493802			520919	483662
Enduro EC 450FSE	450	2003 - 2009	493802			520919	483662
Supermotard SM 450FSE	450	2003 - 2004	493802			520919	483662
Supermotard SM 450FSR	450	2007 - 2009	493802			520919	483662
Wild Quad HP 450	450	2004 - 2009	493802			520919	483662
EC 515FSE	515	2005 - 2009	493802			520919	483662
EC 515FSR	515	2005 - 2009	493802			520919	483662
SM 515FSR	515	2007 - 2009	493802			520919	483662
Wild Quad HP 515	515	2009 - 2009	493802			520919	483662
GILERA							
125XR1	125	1988 - 1988	493810		513055		
125XR1 - XR2	125	1989 - 1989	489938	526367	499700		462573
125XR2	125	1990 - 1993	489938	526367	499700		462573
Arizona RX 125	125	1988 - 1988	493810		513055		
Coguar 125	125	1999 - 2002	489938	526367	499700		462573
DNA 125	125	2001 - 2003	497358		511537		467893
Fastbike 125	125	1987 - 1987	493810		513055		
Freestyle 125	125	1991 - 1993	493810		513055		
GFR 125	125	1994 - 1994	493810		513055		
Nexus 125	125	2007 - 2008	489943		499707	520922	465837
Nexus 125ie	125	2008 - 2011	489946		499708	520922	465838
Rally RC 125	125	1987 - 1988	497358		511537		467893
Runner FX 125	125	1999 - 2002	489938	526367	499700		462573
Runner FXR 125	125	1999 - 2002	489938	526367	499700		462573
Runner SP 125	125	1999 - 2002	489938	526367	499700		462573
Runner VX 125	125	2001 - 2006	489938	526367	499700		462573
Runner VX 125	125	2007 - 2007	489943		499707	520922	465837
Runner VX 125ST	125	2008 - 2013	489943		499707	520922	465837
RV 125	125	1988 - 1988	489938	526367	499700		462573
Top Rally RC 125	125	1989 - 1992	493810		513055		
Typhoon 125	125	1995 - 1998	493812		513057		462571
DNA 180	180	2001 - 2003	493813		511537		465841
Runner FXR 180	180	1999 - 2002	497358		511537		467893
Runner SP 180	180	1999 - 2002	497358		511537		467893
Runner VXR 180	180	2001 - 2004	493803			520923	510622
Arizona Hawk 200	200	1985 - 1985	493810		513055		



Modèle	Cylindre	Année	FULBAT		FULBAT		YUASA
			Préconisation constructeur	Sans entretien acide	Sans entretien gel	Lithium	Réf.
Fast Bike 200	200	1987 - 1987	493810		513055		
RTX 200	200	1985 - 1985	493810		513055		
Runner VXR 200	200	2002 - 2004	493813		511537		465841
Runner VXR 200	200	2005 - 2006	489943		499707	520922	465837
RV 200	200	1985 - 1986	493810		513055		
RV 200ES	200	1987 - 1987	489938	526367	499700		462573
T4 200	200	-	493810		513055		
Arizona Rally RX 250	250	1986 - 1986	497358		511537		467893
NGR 250	250	1985 - 1985	493810		513055		
Nexus 300i	300	2009 - 2012	489943		499707	520922	465837
Nexus 300i	300	2008 - 2008	489946		499708	520922	465838
Dakota 350	350	1985 - 1985	493810		513055		
ER 350	350	1985 - 1988	493810		513055		
XRT 350	350	1990 - 1990	490558	512637	499702		465842
Dakota 500	500	1987 - 1987	493810		513055		
Fuoco LT 500 (4T)	500	2013 - 2015	489946		499708	520922	465838
Fuoco RC 500ie	500	2007 - 2013	490560		517782		478136
Nexus 500	500	2003 - 2008	490558	512637	499702		465842
Nexus 500	500	2009 - 2010	512637		499702		
Nexus 500IE	500	2010 - 2012	512637		499702		
Nexus 500SP	500	2006 - 2007	512637		499702		
RC 600	600	1989 - 1990	490558	512637	499702		465842
XRT 600	600	1988 - 1989	490558	512637	499702		465842
GP 800	800	2008 - 2014	489946		499708	520922	465838
HANWAY							
MUSCLE 125 I	125	-	526329				
Raw 125 Cafe Racer Euro4	125	-	526329				
Raw 125 SR	125	-	526329				
Raw 125i	125	-	526329				
Raw 125SR Chrome SR Sport Euro4	125	-	526329				
Raw Cafe	125	-	526329				
Raw Cafe	125	-	526329				
Raw Cafe Racer	125	-	526329				
Raw Cafe SE Green	125	-	526329				
Scrambler 125	125	-	526329				
Scrambler 125 Euro4	125	-	526329				
HARLEY DAVIDSON							
Street XG 500	500	2014 - 2022	493807				
Street Rod XG 750A	750	2017 - 2022	493807				
Street XG 750	750	2014 - 2022	493807				
Iron XL 883N	883	2009 - 2021	493807				
Roadster XL 883R	883	2010 - 2010	493807				
Sportster Custom XL 53C	883	2000 - 2003	493808			520924	
Sportster Custom XL 883C	883	2004 - 2009	493807				

MOTEUR

CYCLE

PNEUMATIQUE

ATELIER

ACCESSOIRES

ÉLECTRICITÉ

FILTRATION

FREINAGE

TRANSMISSION

Modèle	Cylindre	Année	FULBAT	FULBAT	Lithium	Réf.
			Préconisation constructeur	Sans entretien acide		
Sportster Custom XL 883C	883	1999 - 2003	493808		520924	
Sportster Deluxe XL 883DLX	883	1990 - 1995	513063			510625
Sportster Deluxe XLH 883DLX	883	1988 - 1989	513063			510625
Sportster Flat Track XLH 883R	883	2000 - 2003	493808		520924	
Sportster Hugger XL 883HUG	883	1997 - 2003	493808		520924	
Sportster Hugger XL 883HUG	883	1990 - 1996	513063			510625
Sportster Hugger XLH 883HUG	883	1988 - 1989	513063			510625
Sportster Low XL 883L	883	2005 - 2010	493807			
Sportster R XL 883R	883	2005 - 2010	493807			
Sportster R XL 883R	883	2002 - 2003	493808		520924	
Sportster Standard XL 883	883	2004 - 2008	493807			
Sportster XL 883L	883	2006 - 2009	493807			
Sportster XLH 883	883	1997 - 2003	493808		520924	
Sportster XLH 883	883	1993 - 1996	513063			510625
Sportster XLH 8834 speed	883	1986 - 1990	513063			510625
Sportster XLH 8835 speed	883	1991 - 1992	513063			510625
Superlow XL 883L	883	2011 - 2021	493807			
RH 975 Nighster	975	2022	493807			
Roadster XLS 997	1000	1984 - 1985	513063			510625
Sportster XLH 997	1000	1984 - 1985	513063			510625
XLCH 997	1000	1973 - 1977	513057			472409
XR1000	1000	1984 - 1985	513063			510625
Sportster XLH 1100	1100	1986 - 1987	513063			510625
50th Anniversary Sportster XL 50	1200	2007 - 2007	493807			
Custom 1200 XL 1200C	1200	2019 - 2021	493807			
Custom XL 1200C	1200	2011 - 2011	493807			
Forty Eight Special XL 1200XS	1200	2019 - 2021	493807			
Forty Eight XL 1200X	1200	2010 - 2021	493807			
Iron 1200 XL 1200NS	1200	2019 - 2021	493807			
Nightster XL 1200N	1200	2007 - 2012	493807			
Roadster XL 1200CX	1200	2016 - 2021	493807			
Seventy Two XL 1200V	1200	2012 - 2016	493807			
Sportster Custom XL 1200C	1200	2004 - 2018	493807			
Sportster Custom XL 1200C	1200	1997 - 2003	493808		520924	
Sportster Custom XL 1200C	1200	1996 - 1996	513063			510625
Sportster Low XL 1200L	1200	2006 - 2011	493807			
Sportster Nightster XL 1200N	1200	2008 - 2008	493807			
Sportster Roadster XL 1200R	1200	2004 - 2008	493807			
Sportster Sport XL 1200S	1200	1997 - 2003	493808		520924	
Sportster Sport XL 1200S	1200	1996 - 1996	513063			510625
Sportster XLH 1200	1200	1997 - 2003	493808		520924	
Sportster XLH 1200	1200	1988 - 1996	513063			510625
Sportster XR 1200	1200	2009 - 2010	493807			
Sportster XR 1200X	1200	2010 - 2012	493807			



Modèle	Cylindre	Année	FULBAT		YUASA		Réf.
			Préconisation constructeur	Sans entretien acide	Sans entretien gel	Lithium	
SuperLow XL 1200T	1200	2014 - 2018	493807				
Pan America 1250	1250	2021 - 2022	493807				
Pan America 1250 Special	1250	2021 - 2022	493807				
Pan America 1250 Special G.I	1250	2022 - 2023	493807				
Sportster 1250 S RH1250S	1250	2021 - 2022	493807				
V-Rod Muscle VRSCF 1250	1250	2008 - 2017	493808			520924	
V-Rod VRSCAW 1250	1250	2007 - 2009	493808			520924	
V-Rod VRSCX 1250	1250	2007 - 2007	493808			520924	
Bad Boy FXSTB 1340	1340	1995 - 1996	493808			520924	
Disc Glide FXRDG 1340	1340	1984 - 1984	513063				510625
Dyna Convertible FXDS CON 1340	1340	1995 - 1996	493808			520924	
Dyna Convertible FXDS CON 1340	1340	1997 - 1998	493808			520924	
Dyna Daytona FXDB 1340	1340	1992 - 1992	493808			520924	
Dyna Glide Custom FXDC 1340	1340	1992 - 1992	493808			520924	
Dyna Low Rider Convertible FXDS CON 1340	1340	1994 - 1994	493808			520924	
Dyna Low Rider FXDL 1340	1340	1993 - 1996	493808			520924	
Dyna Low Rider FXDL 1340	1340	1997 - 1998	493808			520924	
Dyna Super Glide FXD 1340	1340	1995 - 1996	493808			520924	
Dyna Super Glide FXD 1340	1340	1995 - 1998	493808			520924	
Dyna Wide Glide FXDWG 1340	1340	1993 - 1996	493808			520924	
Dyna Wide Glide FXDWG 1340	1340	1997 - 1998	493808			520924	
Electra Glide Classic FLHTC 1340	1340	1997 - 2003	504080			520926	
Electra Glide Classic FLHTC 1340	1340	1984 - 1996	511545			520924	
Electra Glide Classic FLHTCI 1340	1340	1997 - 1998	504080			520926	
Electra Glide Classic FLHTCI 1340	1340	1996 - 1996	511545			520924	
Electra Glide Classic Liberty FLHTC 1340	1340	1986 - 1986	511545			520924	
Electra Glide FLH 1340	1340	1978 - 1983	504080			520926	
Electra Glide FLHT 1340	1340	1986 - 1987	511545			520924	
Electra Glide Road King FLHR 1340	1340	1994 - 1994	511545			520924	
Electra Glide Standard FLHT 1340	1340	1997 - 1998	504080			520926	
Electra Glide Standard FLHT 1340	1340	1995 - 1996	511545			520924	
Fat Boy FLSTF 1340	1340	1991 - 1996	493808			520924	
Fat Boy FLSTF 1340	1340	1997 - 1998	493808			520924	
Fat Boy FLSTF 1340	1340	1990 - 1990	513063				510625
FXE 1340	1340	1984 - 1984	513063				510625
Grand Touring Edition FXRD 1340	1340	1986 - 1986	513063				510625
Heritage Softail Classic FLSTC 1340	1340	1991 - 1996	493808			520924	
Heritage Softail Classic FLSTC 1340	1340	1997 - 1998	493808			520924	
Heritage Softail Classic FLSTC 1340	1340	1988 - 1990	513063				510625
Heritage Softail FLST 1340	1340	1986 - 1990	513063				510625
Heritage Softail Nostalgia FLSTN 1340	1340	1993 - 1993	493808			520924	
Heritage Softail Special FLSTN 1340	1340	1994 - 1996	493808			520924	
Heritage Springer FLSTS 1340	1340	1997 - 1998	493808			520924	
Low Glide FXRC 1340	1340	1985 - 1985	513063				510625

MOTEUR

CYCLE

PNEUMATIQUE

ATELIER

ACCESSOIRES

ÉLECTRICITÉ

FILTRATION

FREINAGE

TRANSMISSION

Modèle	Cylindre	Année	FULBAT	FULBAT	YUASA		Réf.
			Préconisation constructeur	Sans entretien acide	Sans entretien gel	Lithium	
Low Glide FXRS 1340	1340	1984 - 1985	513063				510625
Low Rider Chrome FXRC 1340	1340	1987 - 1987	513063				510625
Low Rider Convertible FXDS CON 1340	1340	1990 - 1993	513063				510625
Low Rider Custom FXLR 1340	1340	1987 - 1994	513063				510625
Low Rider FXRS 1340	1340	1986 - 1992	513063				510625
Low Rider FXSB 1340	1340	1984 - 1985	513063				510625
Low Rider Sport Edition FXRS SP 1340	1340	1991 - 1993	513063				510625
Road Glide FLTR 1340	1340	1998 - 1998	504080			520926	
Road King Classic FLHRCI 1340	1340	1998 - 1999	504080			520926	
Road King FLHR 1340	1340	1997 - 1999	504080			520926	
Road King FLHR 1340	1340	1995 - 1996	511545			520924	
Softail Custom FXSTC 1340	1340	1991 - 1996	493808			520924	
Softail Custom FXSTC 1340	1340	1997 - 1999	493808			520924	
Softail Custom FXSTC 1340	1340	1986 - 1990	513063				510625
Softail FXST 1340	1340	1984 - 1990	513063				510625
Sport Glide FXRT 1340	1340	1984 - 1992	513063				510625
Springer Softail FXSTS 1340	1340	1991 - 1996	493808			520924	
Springer Softail FXSTS 1340	1340	1997 - 1998	493808			520924	
Springer Softail FXSTS 1340	1340	1988 - 1990	513063				510625
Sturgis FXDB 1340	1340	1991 - 1991	493808			520924	
Super Glide Fat Bob FXEF 1340	1340	1985 - 1985	513063				510625
Super Glide FXR 1340	1340	1986 - 1994	513063				510625
Tour Glide Classic FLTC 1340	1340	1984 - 1991	511545			520924	
Ultra Classic Electra Glide FLHTCU 1340	1340	1997 - 1997	504080			520926	
Ultra Classic Electra Glide FLHTCU 1340	1340	1989 - 1996	511545			520924	
Ultra Classic Electra Glide FLHTCUI 1340	1340	1997 - 1998	504080			520926	
Ultra Classic Electra Glide FLHTCUI 1340	1340	1995 - 1996	511545			520924	
Ultra Classic Tour Glide FLTCT 1340	1340	1989 - 1995	511545			520924	
Ultra Classic Tour Glide FLTCT 1340	1340	1996 - 1996	511545			520924	
Wide Glide FXWG 1340	1340	1984 - 1986	513063				510625
35th Anniversary Super Glide FXDi 1450	1450	2006 - 2006	493808			520924	
35th Anniversary Super Glide FXDi35 1450	1450	2005 - 2005	493808			520924	
Dyna Low Rider FXDL 1450	1450	1999 - 2005	493808			520924	
Dyna Low Rider FXDLi 1450	1450	2004 - 2006	493808			520924	
Dyna Super Glide Convertible FXDS CON 1450	1450	1999 - 2000	493808			520924	
Dyna Super Glide Custom FXDC 1450	1450	2005 - 2005	493808			520924	
Dyna Super Glide Custom FXDCi 1450	1450	2005 - 2006	493808			520924	
Dyna Super Glide FXD 1450	1450	2000 - 2005	493808			520924	
Dyna Super Glide FXDi 1450	1450	2004 - 2007	493808			520924	
Dyna Super Glide Sport FXDX 1450	1450	1999 - 2005	493808			520924	
Dyna Super Glide Sport FXDXi 1450	1450	2004 - 2005	493808			520924	
Dyna Super Glide T-Sport FXDXT 1450	1450	2001 - 2003	493808			520924	
Dyna Wide Glide FXDWG 1450	1450	1999 - 2005	493808			520924	
Dyna Wide Glide FXDWGi 1450	1450	2004 - 2006	493808			520924	



Modèle	Cylindre	Année	FULBAT		YUASA		Réf.
			Préconisation constructeur	Sans entretien acide	Sans entretien gel	Lithium	
Electra Glide Standard FLHT 1450	1450	1999 - 2007	504080			520926	
Electra Glide Standard FLHTi 1450	1450	2003 - 2006	504080			520926	
Electra Glide Ultra Classic FLHTCUI 1450	1450	1999 - 2006	504080			520926	
Fat Boy FLSTF 1450	1450	1999 - 2006	493808			520924	
Fat Boy FLSTFi 1450	1450	2001 - 2006	493808			520924	
Heritage Softail Classic FLSTC 1450	1450	1999 - 2007	493808			520924	
Heritage Softail Classic FLSTCi 1450	1450	2000 - 2006	493808			520924	
Heritage Softail FLSTi 1450	1450	2006 - 2006	493808			520924	
Heritage Springer FLSTS 1450	1450	1999 - 2003	493808			520924	
Heritage Springer FLSTSi 1450	1450	2001 - 2003	493808			520924	
Night Train FXSTB 1450	1450	1999 - 2006	493808			520924	
Night Train FXSTBi 1450	1450	2001 - 2005	493808			520924	
Night Train Softail FXSTB 1450	1450	2006 - 2006	493808			520924	
Night Train Softail FXSTBi 1450	1450	2006 - 2006	493808			520924	
Road Glide FLTR 1450	1450	1999 - 2007	504080			520926	
Road Glide FLTRi 1450	1450	1998 - 2006	504080			520926	
Road King Custom FLHRS 1450	1450	2004 - 2007	504080			520926	
Road King Custom FLHRSi 1450	1450	2004 - 2006	504080			520926	
Road King FLHR 1450	1450	1999 - 2006	504080			520926	
Softail Deluxe FLSTN 1450	1450	2005 - 2006	493808			520924	
Softail Deluxe FLSTNi 1450	1450	2005 - 2006	493808			520924	
Softail Deuce FXSTD 1450	1450	2000 - 2007	493808			520924	
Softail Deuce FXSTDi 1450	1450	2001 - 2006	493808			520924	
Softail Springer Classic FLSTSC 1450	1450	2005 - 2006	493808			520924	
Softail Springer Classic FLSTSCi 1450	1450	2005 - 2006	493808			520924	
Softail Standard FXST 1450	1450	1999 - 2005	493808			520924	
Softail Standard FXSTi 1450	1450	2001 - 2006	493808			520924	
Springer Softail FXSTS 1450	1450	1999 - 2006	493808			520924	
Springer Softail FXSTSi 1450	1450	2000 - 2006	493808			520924	
Street Bob FXDBi 1450	1450	2006 - 2006	493808			520924	
Super Glide FXD 1450	1450	2010 - 2010	493808			520924	
Softail Cross Bones FLSTSB 1573	1573	2008 - 2008	493808			520924	
Blackline FXS 1584	1584	2011 - 2013	493808			520924	
Cross Bones FLSTSB 1584	1584	2010 - 2011	493808			520924	
Dyna Fat Bob FXDF 1584	1584	2009 - 2009	493808			520924	
Dyna Low Rider FXDL 1584	1584	2007 - 2009	493808			520924	
Dyna Street Bob FXDB 1584	1584	2009 - 2009	493808			520924	
Dyna Super Glide Custom FXDC 1584	1584	2007 - 2009	493808			520924	
Dyna Super Glide FXD 1584	1584	2007 - 2009	493808			520924	
Dyna Wide Glide FXDWG 1584	1584	2007 - 2008	493808			520924	
Electra Glide Classic FLHTC 1584	1584	2004 - 2010	504080			520926	
Electra Glide Classic FLHTCi 1584	1584	1999 - 2006	504080			520926	
Electra Glide Standard FLHT 1584	1584	2008 - 2009	504080			520926	
Fat Bob FXDF 1584	1584	2008 - 2012	493808			520924	
Fat Boy FLSTF 1584	1584	2007 - 2011	493808			520924	

MOTEUR

CYCLE

PNEUMATIQUE

ATELIER

ACCESSOIRES

ÉLECTRICITÉ

FILTRATION

FREINAGE

TRANSMISSION

Modèle	Cylindre	Année	FULBAT	FULBAT	Lithium	Réf.
			Préconisation constructeur	Sans entretien acide		
Fat Boy Lo FLSTFB 1584	1584	2010 - 2014	493808		520924	
Heritage Softail Classic FLSTC 1584	1584	2008 - 2011	493808		520924	
Night Train FXSTB 1584	1584	2007 - 2009	493808		520924	
Night Train Softail FXSTB 1584	1584	2007 - 2007	493808		520924	
Night Train Softail FXSTBi 1584	1584	2007 - 2007	493808		520924	
Road Glide Custom FLTRX 1584	1584	2010 - 2010	504080		520926	
Road Glide FLTR 1584	1584	2008 - 2009	504080		520926	
Road King Classic FLHRC 1584	1584	2007 - 2011	504080		520926	
Road King Classic FLHRCi 1584	1584	1999 - 2006	504080		520926	
Road King FLHR 1584	1584	2007 - 2011	504080		520926	
Road King FLHRI 1584	1584	2000 - 2006	504080		520926	
Rocker C FXCWC 1584	1584	2010 - 2011	493808		520924	
Softail Cross Bones FLSTSB 1584	1584	2009 - 2009	493808		520924	
Softail Custom FXSTC 1584	1584	2007 - 2010	493808		520924	
Softail Deluxe FLSTN 1584	1584	2007 - 2015	493808		520924	
Softail Rocker C FXCWC 1584	1584	2008 - 2009	493808		520924	
Softail Rocker FXCW 1584	1584	2008 - 2009	493808		520924	
Softail Springer Classic FLSTSC 1584	1584	2007 - 2007	493808		520924	
Softail Standard FXST 1584	1584	2006 - 2007	493808		520924	
Street Bob FXDB 1584	1584	2007 - 2017	493808		520924	
Street Glide FLHX 1584	1584	2006 - 2011	504080		520926	
Street Glide FLHXi 1584	1584	2006 - 2006	504080		520926	
Super Glide Custom FXDC 1584	1584	2010 - 2014	493808		520924	
Switchback FLD 1584	1584	2012 - 2013	493808		520924	
Ultra Classic Electra Glide FLHTCU 1584	1584	2007 - 2011	504080		520926	
Ultra LTD FLHTK 1584	1584	2015 - 2016	504080		520926	
Ultra LTD Low FLHTKL 1584	1584	2015 - 2016	504080		520926	
Wide Glide FXDWG 1584	1584	2010 - 2017	493808		520924	
Blackline FXS 1690	1690	2012 - 2013	493808		520924	
Breakout FXSB 1690	1690	2013 - 2017	493808		520924	
Electra Glide Classic FLHTC 1690	1690	2011 - 2013	504080		520926	
Electra Glide Ultra LTD FLHTK 1690	1690	2010 - 2013	504080		520926	
Fat Bob FXDF 1690	1690	2013 - 2017	493808		520924	
Fat Boy FLSTF 1690	1690	2012 - 2017	493808		520924	
Fat Boy Lo FLSTFB 1690	1690	2012 - 2017	493808		520924	
Freewheeler FLRT 1690	1690	2015 - 2016	504080		520926	
Heritage Softail Classic FLSTC 1690	1690	2012 - 2017	493808		520924	
Heritage Softail Deluxe FLSTC 1690	1690	2015 - 2015	493808		520924	
Low Rider FXDL 1690	1690	2014 - 2017	493808		520924	
Low Rider S FXDLS 1690	1690	2016 - 2017	493808		520924	
Road Glide Custom FLTRX 1690	1690	2011 - 2013	504080		520926	
Road Glide FLTRX 1690	1690	2015 - 2016	504080		520926	
Road Glide Special FLTRXS 1690	1690	2015 - 2016	504080		520926	
Road Glide Ultra FLTRU 1690	1690	2011 - 2016	504080		520926	
Road King Classic FLHRC 1690	1690	2012 - 2013	504080		520926	



Modèle	Cylindre	Année	FULBAT		YUASA		Réf.
			Préconisation constructeur	Sans entretien acide	Sans entretien gel	Lithium	
Road King FLHR 1690	1690	2012 - 2016	504080			520926	
Softail Deluxe FLSTN 1690	1690	2012 - 2017	493808			520924	
Softail Slim FLS 1690	1690	2012 - 2017	493808			520924	
Street Bob FXDB 1690	1690	2012 - 2017	493808			520924	
Street Glide FLHX 1690	1690	2012 - 2016	504080			520926	
Street Glide Special FLHXS 1690	1690	2014 - 2016	504080			520926	
Street Glide Trike FLHXXX 1690	1690	2010 - 2011	504080			520926	
Switchback FLD 1690	1690	2014 - 2016	493808			520924	
Tri Glide Ultra Classic Trike FLHTCUTG 1690	1690	2009 - 2013	504080			520926	
Tri Glide Ultra Trike FLHTCUTG 1690	1690	2014 - 2016	504080			520926	
Ultra Classic Electra Glide FLHTCU 1690	1690	2012 - 2017	504080			520926	
Ultra Classic Electra Glide Low FLHTCUL 1690	1690	2015 - 2016	504080			520926	
Ultra Limited FLHTK 1690	1690	2015 - 2016	504080			520926	
Ultra Limited Low FLHTKL 1690	1690	2015 - 2018	504080			520926	
Ultra LTD FLHTK 1690	1690	2014 - 2014	504080			520926	
Wide Glide FXDWG 1690	1690	2010 - 2017	493808			520924	
Breakout FXBR 1750	1750	2018 - 2021	493808			520924	
Deluxe FLDE 1750	1750	2018 - 2021	493808			520924	
Electra Glide Standard FLHT	1750	2019 - 2021	504080			520926	
Electra Glide Ultra Classic FLHTCU 1750	1750	2017 - 2021	504080			520926	
Fat Bob FXBS 1750	1750	2018 - 2018	493808			520924	
Fat Bob FXFB 1750	1750	2018 - 2021	493808			520924	
Fat Boy FLFB 1750	1750	2018 - 2021	493808			520924	
Freewheeler FLRT 1750	1750	2017 - 2021	504080			520926	
Heritage Classic FLHC 1750	1750	2018 - 2021	493808			520924	
Low Rider FXLR 1750	1750	2018 - 2021	493808			520924	
Low Rider S FXLRS 1750	1750	2020 - 2021	493808			520924	
Road Glide FLTRX 1750	1750	2017 - 2021	504080			520926	
Road Glide Limited FL TRK 1750	1750	2020 - 2021	504080			520926	
Road Glide Special FL TRXS 1750	1750	2017 - 2021	504080			520926	
Road Glide Ultra FLTRU 1750	1750	2017 - 2021	504080			520926	
Road King FLHR 1750	1750	2017 - 2022	504080			520926	
Road King Special FLHRXS 1750	1750	2017 - 2021	504080			520926	
Softail Slim FLSL 1750	1750	2018 - 2021	493808			520924	
Softail Standard FXST 1750	1750	2020 - 2021	493808			520924	
Sport Glide FLSB 1750	1750	2018 - 2022	493808			520924	
Street Bob FXBB 1750	1750	2018 - 2021	493808			520924	
Street Glide FLHX 1750	1750	2017 - 2021	504080			520926	
Street Glide Special FLHXS 1750	1750	2017 - 2021	504080			520926	
Tri Glide Ultra FLHTCUTG 1750	1750	2017 - 2021	504080			520926	
Ultra Limited FLHTK 1750	1750	2017 - 2021	504080			520926	
Ultra Limited Low FLHTKL 1750	1750	2019 - 2021	504080			520926	
Ultra Limited Shrine Edition FLHTK 1750	1750	2018 - 2018	504080			520926	
Fat Boy S FLSTFBS 1800	1800	2016 - 2017	493808			520924	

MOTEUR

CYCLE

PNEUMATIQUE

ATELIER

ACCESSOIRES

ÉLECTRICITÉ

FILTRATION

FREINAGE

TRANSMISSION

MOTEUR

CYCLE

PNEUMATIQUE

ATELIER

ACCESSOIRES

ÉLECTRICITÉ

FILTRATION

FREINAGE

TRANSMISSION

Modèle	Cylindre	Année	FULBAT	FULBAT	Lithium	Réf.	
			Préconisation constructeur	Sans entretien acide			Sans entretien gel
Softail Slim S FLSS 1800	1800	2016 - 2017	493808		520924		
Breakout 114 Anniversary FXBRS 1868	1868	2018 - 2018	493808		520924		
Breakout 114 FXBRS 1868	1868	2018 - 2022	493808		520924		
Electra Glide Revival FLH 1868	1868	2021	504080		520926		
Fat Bob 114 FXFBS 1868	1868	2018 - 2022	493808		520924		
Fat Bob FXBS 1868	1868	2018 - 2018	493808		520924		
Fat Bob FXFB 1868	1868	2018 - 2018	493808		520924		
Fat Boy 114 Anniversary FLFBS 1868	1868	2018 - 2018	493808		520924		
Fat Boy 114 FLFBS 1868	1868	2018 - 2022	493808		520924		
Freewheeler FLRT 1868	1868	2019 - 2022	504080		520926		
FXDR 114 FXDRS FXDR 1868	1868	2019 - 2021	493808		520924		
Heritage Classic 114 Anniversary FLHCS 1868	1868	2018 - 2018	493808		520924		
Road Glide Limited FLTRK 1868	1868	2021	504080		520926		
Road Glide Special FLTRXS 1868	1868	2021 - 2022	504080		520926		
Road Glide Ultra FLTRU 1868	1868	2019	504080		520926		
Road King Special FLHRXS 1868	1868	2019 - 2022	504080		520926		
Softail FXDR 114 1868	1868	2019 - 2020	493808		520924		
Softail Heritage Classic 114 FLHC S 1868	1868	2018 - 2022	493808		520924		
Softail Low Rider S FXLRS 1868	1868	2020 - 2021	493808		520924		
Softail Street Bob FXBB 1868	1868	2021 - 2022	493808		520924		
Street Glide Special Arctic Blast Limited Edition FLHXS 1868	1868	2021 - 2022	504080		520926		
Street Glide Special FLHXS 1868	1868	2021 - 2022	504080		520926		
Tri Glide Ultra FLHTCUTG 1868	1868	2019 - 2022	504080		520926		
Ultra Limited FLHTK 1868	1868	2019 - 2022	504080		520926		
Ultra Limited Low FLHTKL 1868	1868	2019	504080		520926		
1923 Road Glide ST FLHXST	1923	2022 - 2023	504080		520926		
1923 Softail Low Rider S FXLRS	1923	2022 - 2023	493808		520924		
1923 Street Glide ST FLHXST	1923	2022 - 2023	504080		520926		
CVO 1923 Limited FLHTKSE	1923	2021	504080		520926		
CVO 1923 Limited FLHTKSE	1923	2018 - 2020	504080		520926		
CVO 1923 Road Glide FLTRXSE	1923	2018 - 2022	504080		520926		
CVO 1923 Road Glide Limited FLHTKSE	1923	2022	504080		520926		
CVO 1923 Street Glide FLHXSE	1923	2021	504080		520926		
CVO 1923 Street Glide FLHXSE	1923	2018 - 2020	504080		520926		
CVO 1923 Street Glide FLTRXSE	1923	2022 - 2023	504080		520926		
CVO Tri Glide FLHTCUTGSE 1923	1923	2020 - 2022	504080		520926		
HONDA							
ATC 125M	125	1986 - 1986	489943		499707	520922	465837
Big Wheels CRF 125FB	125	2020 - 2020	489939			520919	506882
Big Wheels CRF 125FB	125	2014 - 2020	489937		489939	520919	465833
Bros NXR 125	125	2005 - 2005	489944		499703	520919	465835
Cargo CG 125	125	2009 - 2010	489937		489939	520919	465833
CB 125	125	1976 - 1983	512639		517777		



Modèle	Cylindre	Année	FULBAT		YUASA		
			Préconisation constructeur	Sans entretien acide	Sans entretien gel	Lithium	Réf.
CB 125	125	1972 - 1976					
CB 125 R	125	2023 -	500281			520919	506883
CB 125J	125	1975 - 1975	512639		517777		
CB 125JX	125	1975 - 1979	512639		517777		
CB 125N	125	1979 - 1979	512639		517777		
CB 125S	125	1975 - 1979	512639		517777		
CB 125T	125	1977 - 1978	512639		517777		
CB 125T2	125	1978 - 1982	512639		517777		
CB 125TD	125	1982 - 1988	489938	526367	499700		462573
CBF 125 N NA, CB 125R	125	2018 - 2021	499703			520919	510612
CBF 125M	125	2009 - 2016	489942		499705	520919	465840
CBR 125R	125	2012 - 2016	499703			520919	510612
CBR 125R	125	2004 - 2006	493802			520919	483662
CBR 125RW	125	2011 - 2011	499703			520919	510612
CBR 125RW	125	2005 - 2010	493802			520919	483662
CBX 125F	125	1984 - 1984	512639		517777		
CG 125	125	1977 - 2003	489937		489939	520919	465833
CG 125BR	125	1985 - 1997	489937		489939	520919	465833
CG 125ES	125	2004 - 2008	489944		499703	520919	465835
City Fly CLR 125W	125	1998 - 2003	489944		499703	520919	465835
CM 125C	125	1982 - 1985	489938	526367	499700		462573
CM 125T	125	1981 - 1982	489938	526367	499700		462573
CRM 125R	125	1990 - 1999	489937		489939	520919	465833
CT 125C	125	1985 - 1985					
Custom CBX 125	125	1988 - 1988	512639		517777		
Custom CBX 125TS	125	1982 - 1982	512639		517777		
Dax 125	125	2022 - 2023	489939			520919	506882
Dylan SES 125	125	2002 - 2007	489942		499705	520919	465840
Forza NSS 125AD	125	2015 - 2023	500281			520919	506883
GLR 125 CB 125F	125	2015 - 2021	489942		499705	520919	465840
Grom MSX 125	125	2013 - 2017	489939			520919	506882
Grom MSX 125A	125	2017 - 2021	489939			520919	506882
Innova ANF 125	125	2003 - 2011	493802			520919	483662
Job CG 125	125	2005 - 2005	489937		489939	520919	465833
Lead NH 125	125	1986 - 1987	489935		511534	520919	462568
Lead NH 125MD	125	1983 - 1983	489935		511534	520919	462568
MBX 125F	125	1984 - 1986	489935		511534	520919	462568
Mode SH 125	125	2014 - 2018	493802			520919	483662
Monkey Z 125MA	125	2018 - 2023	489939			520919	506882
MTX 125R	125	1986 - 1995	489935		511534	520919	462568
MTX 125RW	125	1983 - 1995	489945		511532		465832
NES 125	125	2000 - 2006	489942		499705	520919	465840
NS 125F	125	1986 - 1987	489935		511534	520919	462568
NS 125R	125	1987 - 1987	489935		511534	520919	462568
NSR 125F	125	1988 - 1992	489944		499703	520919	465835

MOTEUR

CYCLE

PNEUMATIQUE

ATELIER

ACCESSOIRES

ÉLECTRICITÉ

FILTRATION

FREINAGE

TRANSMISSION

Modèle	Cylindre	Année	FULBAT	FULBAT	Lithium	Réf.	
			Préconisation constructeur	Sans entretien acide			Sans entretien gel
NSR 125R	125	1989 - 2001	489944		499703	520919	465835
Pantheon FES 125	125	2003 - 2006	489942		499705	520919	465840
Pantheon FES 125	125	1998 - 2002	489940		499706	520922	465836
Paris Dakar XL 125	125	1985 - 1987	489938	526367	499700		462573
PCX 125	125	2010 - 2017	493802			520919	483662
PCX PCX 125A	125	2018 - 2020	500281			520919	506883
PS125 PES 125	125	2006 - 2013	489942		499705	520919	465840
PS125 PES 125R	125	2008 - 2013	489942		499705	520919	465840
Rebel CA 125	125	1995 - 2000	489942		499705	520919	465840
Scoopy SH 125	125	2001 - 2004	489942		499705	520919	465840
Scoopy SH 125i	125	2004 - 2012	489942		499705	520919	465840
Scoopy SH 125iD	125	2009 - 2009	489942		499705	520919	465840
Scoopy SH 125iR	125	2008 - 2013	489942		499705	520919	465840
Scoopy SH 125iS	125	2007 - 2011	489942		499705	520919	465840
SH 125	125	2013 - 2016	493802			520919	483662
SH 125A	125	2013 - 2014	493802			520919	483662
SH 125AD	125	2013 - 2015	493802			520919	483662
SH 125D	125	2013 - 2016	493802			520919	483662
SH 125i	125	2014 - 2020	493802			520919	483662
SH 125S	125	2016 - 2016	493802			520919	483662
Shadow VT 125C	125	1999 - 2008	489942		499705	520919	465840
Shadow VT 125C	125	2001 - 2003	493802			520919	483662
Shadow VT 125C2	125	2000 - 2000	489942		499705	520919	465840
Shadow VT 125C2	125	2001 - 2001	493802			520919	483662
SL 125	125	1976 - 1980	512639		517777		
Small Wheels CRF 125F	125	2020 - 2020	489939			520919	506882
Small Wheels CRF 125F	125	2014 - 2020	489937		489939	520919	465833
Spacy CH 125	125	1983 - 1986	489938	526367	499700		462573
Spacy CH 125	125	1988 - 1996	489940		499706	520922	465836
Sporty SH 125ADS	125	2014 - 2016	493802			520919	483662
Sporty SH 125AS	125	2014 - 2016	493802			520919	483662
Sporty SH 125DS	125	2014 - 2014	493802			520919	483662
Sporty SH 125S	125	2014 - 2014	493802			520919	483662
Super Cub C 125A	125	2019 - 2020	489939			520919	506882
Supra X ANF 125	125	2011 - 2012	493802			520919	483662
S-Wing FES 125	125	2007 - 2013	489942		499705	520919	465840
S-Wing FES 125A	125	2007 - 2015	489942		499705	520919	465840
TL 125	125	1976 - 1989					
Top Box SH 125AD	125	2017 - 2017	493802			520919	483662
Transcity NX 125	125	1989 - 1997	489942		499705	520919	465840
TRX 125	125	1988 - 1988	489940		499706	520922	465836
Varadero XL 125V	125	2000 - 2016	493802			520919	483662
Wave ANF 125	125	2011 - 2012	493802			520919	483662
XL 125	125	1978 - 1978					
XL 125R	125	1982 - 1997	489938	526367	499700		462573



Modèle	Cylindre	Année	FULBAT		YUASA		Réf.
			Préconisation constructeur	Sans entretien acide	Sans entretien gel	Lithium	
XL 125S	125	1979 - 1982	491024		517776		502678
XLR 125R	125	1997 - 2001	489941		499704	520922	465834
XR 125L	125	2003 - 2008	489944		499703	520919	465835
CBF 150	150	2011 - 2012	489942		499705	520919	465840
CRF 150F	150	2006 - 2017	489944		499703	520919	465835
Dylan SES 150	150	2002 - 2006	489942		499705	520919	465840
NES 150	150	2001 - 2006	489942		499705	520919	465840
Pantheon FES 150 (2T)	150	2003 - 2003	489942		499705	520919	465840
Pantheon FES 150 (2T)	150	1998 - 2002	489940		499706	520922	465836
Pantheon FES 150 (4T)	150	2004 - 2006	489942		499705	520919	465840
PSI50 PES 150	150	2006 - 2010	489942		499705	520919	465840
PSI50 PES 150R	150	2008 - 2011	489942		499705	520919	465840
Scoopy SH 150	150	2001 - 2003	489942		499705	520919	465840
Scoopy SH 150i	150	2004 - 2012	489942		499705	520919	465840
Scoopy SH 150iD	150	2009 - 2009	489942		499705	520919	465840
Scoopy SH 150iR	150	2008 - 2014	489942		499705	520919	465840
Scoopy SH 150iS	150	2007 - 2011	489942		499705	520919	465840
SH 150	150	2013 - 2014	493802			520919	483662
SH 150A	150	2013 - 2014	493802			520919	483662
SH 150AD	150	2013 - 2014	493802			520919	483662
SH 150D	150	2013 - 2014	493802			520919	483662
SH 150i Std - A - D	150	2014 - 2018	493802			520919	483662
Sporty SH 150ADS	150	2014 - 2014	493802			520919	483662
Sporty SH 150AS	150	2014 - 2014	493802			520919	483662
Sporty SH 150DS	150	2014 - 2014	493802			520919	483662
Sporty SH 150S	150	2014 - 2014	493802			520919	483662
S-Wing FES 150	150	2007 - 2013	489942		499705	520919	465840
S-Wing FES 150A	150	2007 - 2013	489942		499705	520919	465840
Titan CG 150ES	150	2004 - 2005	489942		499705	520919	465840
Titan CG 150ESD	150	2004 - 2005	489942		499705	520919	465840
WW150 PCX 150A	150	2018 - 2020	500281			520919	506883
WW150EX PCX 150	150	2010 - 2014	493802			520919	483662
WW150EX PCX 150	150	2015 - 2020	500281			520919	506883
ATC 185	185	1980 - 1980	501411		513059		
ATC 185S	185	1981 - 1981	501411		513059		
XL 185S	185	1979 - 1981	491024		517776		502678
ATC 200	200	1981 - 1983	501411		513059		
ATC 200ES	200	1984 - 1985	501411		513059		
ATC 200S	200	1984 - 1984	501411		513059		
ATC 200X	200	1983 - 1983	501411		513059		
CB 200B	200	1976 - 1979	489938	526367	499700		462573
CM 200T	200	1980 - 1984	489938	526367	499700		462573
MTX 200RW	200	1983 - 1986	489945		511532		465832
TLR 200	200	1983 - 1987					
TRX 200	200	1990 - 1993	489943		499707	520922	465837

MOTEUR

CYCLE

PNEUMATIQUE

ATELIER

ACCESSOIRES

ÉLECTRICITÉ

FILTRATION

FREINAGE

TRANSMISSION

Modèle	Cylindre	Année	FULBAT	FULBAT	YUASA		Réf.
			Préconisation constructeur	Sans entretien acide	Sans entretien gel	Lithium	
TRX 200D	200	1991 - 1997	489943		499707	520922	465837
TRX 200SX	200	1986 - 1987	489943		499707	520922	465837
XL 200R	200	1982 - 1990	489945		511532		465832
FTR 223	223	2000 - 2002	489944		499703	520919	465835
FTR 223A	223	2002 - 2002	489944		499703	520919	465835
CRF 230F	230	2004 - 2020	489944		499703	520919	465835
CRF 230L	230	2008 - 2010	493802			520919	483662
CRF 230M	230	2009 - 2010	493802			520919	483662
Free landsports SL 230	230	1997 - 2001	489944		499703	520919	465835
XL 230	230	2002 - 2002	489944		499703	520919	465835
ATC 250ES	250	1985 - 1988	489943		499707	520922	465837
ATC 250R	250	1981 - 1986	489943		499707	520922	465837
AX-1 NX 250	250	1989 - 1994	489942		499705	520919	465840
Big Ruckus PS 250	250	2005 - 2006	490330			520922	490511
CB 250N	250	1979 - 1981	524567		511538		
CB 250ND	250	1981 - 1982	524567		511538		
CB 250RS	250	1980 - 1983	489938	526367	499700		462573
CB 250T	250	1978 - 1978	524567		511538		
CBF 250	250	2004 - 2006	489942		499705	520919	465840
CBR 250R	250	1987 - 2013	489942		499705	520919	465840
CBR 250RA	250	2011 - 2013	489942		499705	520919	465840
CBR 250RR	250	1990 - 1994	489942		499705	520919	465840
CBX 250	250	1984 - 1998	489942		499705	520919	465840
CBX 250RS	250	1984 - 1984	489942		499705	520919	465840
CD 250U	250	1988 - 1992	489940		499706	520922	465836
CJ 250T	250	1977 - 1977	489938	526367	499700		462573
CL 250S	250	1982 - 1982	524567		511538		
Clubman GB 250	250	1984 - 1994	489938	526367	499700		462573
Clubman GB 250	250	1995 - 1997	489940		499706	520922	465836
CM 250	250	1983 - 1984	489938	526367	499700		462573
CM 250C	250	1982 - 1985	489938	526367	499700		462573
CM 250T	250	1981 - 1981	489938	526367	499700		462573
CMX 250	250	1988 - 1988	489942		499705	520919	465840
CN 250	250	2000 - 2007	489943		499707	520922	465837
CRF 250L	250	2012 - 2015	489942		499705	520919	465840
CRF 250LA	250	2017 - 2020	500281			520919	506883
CRF 250M	250	2013 - 2016	489942		499705	520919	465840
CRF 250R	250	2018 - 2023	512625				
CRF 250RX	250	2019 - 2023	512625				
CRF 250X	250	2004 - 2018	489944		499703	520919	465835
Elite CH 250	250	1987 - 1990	489943		499707	520922	465837
Foresight FES 250	250	1998 - 2000	489943		499707	520922	465837
Foresight FES 250	250	2001 - 2005	490330			520922	490511
Forza NSS 250A	250	2000 - 2011	490330			520922	490511
Forza NSS 250AX	250	2005 - 2006	490330			520922	490511



Modèle	Cylindre	Année	FULBAT		YUASA		
			Préconisation constructeur	Sans entretien acide	Sans entretien gel	Lithium	Réf.
Forza NSS 250EX	250	2005 - 2008	490330			520922	490511
Fusion CN 250	250	2003 - 2003	489943		499707	520922	465837
Hornet CB 250F	250	1996 - 2001	489942		499705	520919	465840
Jazz NSS 250	250	2000 - 2007	490330			520922	490511
Jazz NSS 250A	250	2003 - 2004	490330			520922	490511
Magna VT 250C	250	1994 - 1997	489942		499705	520919	465840
Nighthawk CB 250	250	1992 - 2000	489942		499705	520919	465840
NS 250F	250	1984 - 1984	489937		489939	520919	465833
NS 250R	250	1984 - 1986	489937		489939	520919	465833
NSR 250R	250	1986 - 1994	489937		489939	520919	465833
NSR 250R2	250	1994 - 1994	489937		489939	520919	465833
NX 250	250	1987 - 1993	489942		499705	520919	465840
NX 2502	250	1990 - 1993	489942		499705	520919	465840
Rally CRF 250RL	250	2017 - 2017	500281			520919	506883
Rally CRF 250RLA	250	2017 - 2020	500281			520919	506883
Re Con TRX 250	250	2000 - 2014	489943		499707	520922	465837
Rebel CMX 250C	250	1996 - 2000	489942		499705	520919	465840
Reflex NSS 250	250	2000 - 2007	490330			520922	490511
Spacy CH 250	250	1985 - 1986	489943		499707	520922	465837
Spada VT 250FL	250	1988 - 1990	489942		499705	520919	465840
Spazio CN 250	250	1999 - 1999	489943		499707	520922	465837
Spazio - Helix CN 250	250	1987 - 1998	489943		499707	520922	465837
TRX 250	250	1985 - 1999	489943		499707	520922	465837
TRX 250EX	250	2001 - 2008	489940		499706	520922	465836
TRX 250R	250	1986 - 1989	489943		499707	520922	465837
TRX 250X	250	2009 - 2014	489940		499706	520922	465836
Two Fifty CB 250	250	1992 - 2005	489942		499705	520919	465840
VT 250F	250	1983 - 1986	489938	526367	499700		462573
VTR 250	250	1998 - 2002	489942		499705	520919	465840
VTR 250	250	2003 - 2010	493802			520919	483662
XL 250	250	1978 - 1979	491024		517776		502678
XL 250	250	1982 - 1982	489945		511532		465832
XL 250R	250	1982 - 1987	489945		511532		465832
XL 250S	250	1978 - 1981	491024		517776		502678
ADV 350	300	2021 - 2023	490331			520922	483849
CB 300FA	300	2015 - 2020	489942		499705	520919	465840
CBF 300 NA CB 300R	300	2018 - 2020	500281			520919	506883
CBR 300R	300	2019 - 2020	489942		499705	520919	465840
CBR 300RA	300	2014 - 2017	489942		499705	520919	465840
CMX 300A	300	2019 - 2020	500281			520919	506883
Forza NSS 300	300	2013 - 2015	490330			520922	490511
Forza NSS 300A	300	2018 - 2020	490331			520922	483849
Forza NSS 300A	300	2013 - 2017	490330			520922	490511
Scoopy SH 300AR	300	2012 - 2013	490330			520922	490511
Scoopy SH 300i	300	2007 - 2013	490330			520922	490511

MOTEUR

CYCLE

PNEUMATIQUE

ATELIER

ACCESSOIRES

ÉLECTRICITÉ

FILTRATION

FREINAGE

TRANSMISSION

Modèle	Cylindre	Année	FULBAT		YUASA		Réf.
			Préconisation constructeur	Sans entretien acide	Sans entretien gel	Lithium	
Scoopy SH 300iA	300	2007 - 2014	490330			520922	490511
Scoopy SH 300iAR	300	2008 - 2010	490330			520922	490511
Scoopy SH 300iR	300	2008 - 2013	490330			520922	490511
SH 300i	300	2013 - 2020	490330			520922	490511
Sporty SH 300AR	300	2014 - 2015	490330			520922	490511
Sporty SH 300iR	300	2014 - 2014	490330			520922	490511
TRX 300	300	1988 - 2000	489946		499708	520922	465838
TRX 300EX	300	1993 - 2008	489940		499706	520922	465836
TRX 300FW	300	1988 - 2000	489946		499708	520922	465838
TRX 300X	300	2009 - 2009	489940		499706	520922	465836
CB 350	350	1974 - 1974	524567		511538		
CB 350S	350	1986 - 1990	524568		511538		
Forza 350 NSS 350 AM, 6ED	350	2021 - 2023	490331			520922	483849
Four CB 350F	350	1972 - 1975	524567		511538		
Odyssey FL 350R	350	1985 - 1987	489943		499707	520922	465837
Rancher TRX 350ES	350	2000 - 2003	489946		499708	520922	465838
SH 350i	350	2021 - 2023	490330			520922	490511
TRX 350	350	1986 - 1993	489946		499708	520922	465838
XL 350R	350	1984 - 1987	489945		511532		465832
CB 360	360	1975 - 1975	524567		511538		
CJ 360T	360	1978 - 1978	489938	526367	499700		462573
Bros NT 400	400	1988 - 1988	489940		499706	520922	465836
CB 400F	400	1975 - 1979	524567		511538		
CB 400N	400	1978 - 1983	524567		511538		
CB 400SS	400	2001 - 2005	490563		513062		
CB 400T	400	1978 - 1978	489938	526367	499700		462573
CB-1400	400	1989 - 1990	489940		499706	520922	465836
CBR 400R	400	1986 - 1987	489940		499706	520922	465836
CBR 400RR	400	1988 - 1994	489940		499706	520922	465836
CBX 400F,F2	400	1982 - 1983	524567		511538		
CM 400T	400	1979 - 1981	524567		511538		
CM 400T	400	1982 - 1983	524567		511538		
FJS400 SW-T 400A	400	2009 - 2016	490330			520922	490511
FJS400 SW-T 400D	400	2009 - 2009	490330			520922	490511
Fourtrax Rancher at Gscape TRX 400FGA	400	2004 - 2007	489946		499708	520922	465838
Fourtrax TRX 400FA	400	2004 - 2007	489946		499708	520922	465838
Honda Matic CB 400	400	1980 - 1980	524567		511538		
NS 400R	400	1985 - 1989	489944		499703	520919	465835
Odyssey Pilot FL 400R	400	1989 - 1993	489946		499708	520922	465838
RVF 400R	400	1994 - 1996	489941		499704	520922	465834
Shadow Slasher NV 400DC	400	2000 - 2002	490331			520922	483849
Silverwing FJS 400A	400	2009 - 2011	490330			520922	490511
Silverwing FJS 400D	400	2006 - 2010	490330			520922	490511
Steed NV 400C	400	1988 - 1997	489940		499706	520922	465836
Superfour CB 400SF	400	1999 - 2001	489941		499704	520922	465834



Modèle	Cylindre	Année	FULBAT		YUASA		
			Préconisation constructeur	Sans entretien acide	Sans entretien gel	Lithium	Réf.
Superfour CB 400SF	400	1992 - 1996	489940		499706	520922	465836
Superfour CB 400SF	400	2002 - 2005	490331			520922	483849
Superfour CB 400SF2	400	1997 - 1997	489940		499706	520922	465836
Superfour CB 400SF3	400	1997 - 1997	489940		499706	520922	465836
TRX 400EX	400	1999 - 2008	489940		499706	520922	465836
TRX 400FW	400	1995 - 2002	489946		499708	520922	465838
TRX 400X	400	2009 - 2015	489940		499706	520922	465836
VF 400F	400	1983 - 1985	524567		511538		
VFR 400R	400	1985 - 1988	500869				
VFR 400R	400	1989 - 1992	489941		499704	520922	465834
VRX 400	400	1996 - 1996	489940		499706	520922	465836
Fourtrax Auto TRX 420FA	420	2009 - 2011	489946		499708	520922	465838
Fourtrax Auto TRX 420FM	420	2007 - 2011	489946		499708	520922	465838
Fourtrax Auto TRX 420FPA	420	2009 - 2011	489946		499708	520922	465838
Fourtrax ES TRX 420TE	420	2007 - 2009	489946		499708	520922	465838
Fourtrax Rancher ES TRX 420TE	420	2007 - 2008	489946		499708	520922	465838
Fourtrax TRX 420FE	420	2007 - 2011	489946		499708	520922	465838
Fourtrax TRX 420FPM	420	2009 - 2011	489946		499708	520922	465838
TRX 420TM	420	2007 - 2011	489946		499708	520922	465838
CB 450DX	450	1989 - 1992	524567		511538		
CB 450S	450	1986 - 1987	524568		511538		
CB 450S	450	1988 - 1988	524570		511540		
CB 450T	450	1982 - 1982	524567		511538		
CRF 450 L, RL, X CRF 450RLM	450	2021 - 2023	512625				
CRF 450L	450	2019 - 2023	512625				
CRF 450R	450	2019 - 2023	512625				
CRF 450R	450	2017 - 2017	489937		489939	520919	465833
CRF 450R, RX ENDURO, RW CRF 450RM	450	2021 - 2023	512625				
CRF 450RX	450	2019 - 2023	512625				
CRF 450RX	450	2017 - 2017	489937		489939	520919	465833
CRF 450X	450	2005 - 2018	493802			520919	483662
Rebel CMX 450C	450	1987 - 1988	524567		511538		
TRX 450ES	450	1998 - 2001	489946		499708	520922	465838
TRX 450R	450	2004 - 2014	493802			520919	483662
CB 500	500	1975 - 1976	524567		511538		
CB 500	500	1994 - 2003	489940		499706	520922	465836
CB 500F	500	1977 - 1977	524567		511538		
CB 500F	500	2013 - 2016	490331			520922	483849
CB 500FA	500	2013 - 2023	490331			520922	483849
CB 500S	500	1998 - 2003	489940		499706	520922	465836
CB 500T	500	1975 - 1977	524567		511538		
CB 500X	500	2013 - 2015	490331			520922	483849
CB 500XA	500	2013 - 2018	490331			520922	483849
CB 500XA	500	2019 - 2021	500281			520919	506883
CBF 500	500	2004 - 2007	490331			520922	483849

Modèle	Cylindre	Année	FULBAT	FULBAT	Lithium	Réf.	
			Préconisation constructeur	Sans entretien acide			Sans entretien gel
CBF 500A	500	2004 - 2007	490331		520922	483849	
CBR 500F	500	1987 - 1990	489940		499706	520922	465836
CBR 500R	500	2013 - 2017	490331			520922	483849
CBR 500RA	500	2013 - 2018	490331			520922	483849
CBR 500RA	500	2019 - 2023	500281			520919	506883
CL 500	500	2023 -	500281			520919	506883
CMX 500 REBEL CMX500A2L, AL, AL_J	500	2021 - 2023	500281			520919	506883
CMX 500 REBEL CMX500A2M, AM, M	500	2021 - 2023	500281			520919	506883
CMX 500A	500	2017 - 2020	500281			520919	506883
CX 500	500	1979 - 1981	490558	512637	499702		465842
CX 500C	500	1980 - 1982	490558	512637	499702		465842
CX 500E	500	1982 - 1982	490558	512637	499702		465842
Dominator NX 500	500	1988 - 1999	489940		499706	520922	465836
Fourtrax Foreman Auto TRX 500FA	500	2001 - 2011	489946		499708	520922	465838
Fourtrax Foreman TRX 500FA	500	2012 - 2013	489946		499708	520922	465838
Fourtrax Foreman TRX 500FE	500	2005 - 2012	489946		499708	520922	465838
Fourtrax Foreman TRX 500FM	500	2005 - 2012	489946		499708	520922	465838
Fourtrax Foreman TRX 500FPE	500	2008 - 2012	489946		499708	520922	465838
Fourtrax Foreman TRX 500TM	500	2005 - 2006	489946		499708	520922	465838
FT 500	500	1982 - 1984	490558	512637	499702		465842
Silver Wing GL 500D	500	1982 - 1982	490558	512637	499702		465842
Turbo CX 500TC	500	1982 - 1982	490558	512637	499702		465842
VF 500F	500	1983 - 1984	524567		511538		
VF 500F2	500	1985 - 1987	524567		511538		
VT 500E	500	1983 - 1985	524567		511538		
XBR 500	500	1985 - 1987	524568		511538		
XBR 500S	500	1986 - 1988	524568		511538		
XL 500R	500	1982 - 1987	489945		511532		465832
XL 500S	500	1979 - 1981	491024		517776		502678
CB 550F K	550	1977 - 1980	524567		511538		
CBX 550F	550	1982 - 1983	524567		511538		
CBF 600N	600	2004 - 2007	489942		499705	520919	465840
CBF 600N	600	2008 - 2012	490331			520922	483849
CBF 600NA	600	2004 - 2007	489942		499705	520919	465840
CBF 600NA	600	2008 - 2012	490331			520922	483849
CBF 600S	600	2004 - 2007	489942		499705	520919	465840
CBF 600S	600	2008 - 2013	490331			520922	483849
CBF 600SA	600	2004 - 2007	489942		499705	520919	465840
CBF 600SA	600	2008 - 2013	490331			520922	483849
CBR 600F	600	1987 - 2000	489940		499706	520922	465836
CBR 600F	600	2001 - 2013	490331			520922	483849
CBR 600F4	600	1999 - 2000	489940		499706	520922	465836
CBR 600FA	600	2011 - 2013	490331			520922	483849
CBR 600FS	600	2001 - 2002	490331			520922	483849
CBR 600RA	600	2009 - 2020	490331			520922	483849



Modèle	Cylindre	Année	FULBAT		YUASA		
			Préconisation constructeur	Sans entretien acide	Sans entretien gel	Lithium	Réf.
CBR 600RR	600	2003 - 2020	490331			520922	483849
Hornet CB 600F	600	1998 - 2006	489942		499705	520919	465840
Hornet CB 600F	600	2007 - 2013	490331			520922	483849
Hornet CB 600FA	600	2000 - 2004	489942		499705	520919	465840
Hornet CB 600FA	600	2007 - 2013	490331			520922	483849
Revere NTV 600	600	1988 - 1992	489940		499706	520922	465836
Shadow Custom VT 600C	600	1986 - 2000	489940		499706	520922	465836
SilverWing FJS 600	600	2001 - 2002	490330			520922	490511
SilverWing FJS 600A	600	2003 - 2016	490330			520922	490511
SilverWing FJS 600D	600	2003 - 2012	490330			520922	490511
Transalp XL 600V	600	1987 - 2000	524568		511538		
XL 600LM	600	1985 - 1987	524569	512638	511540		
XL 600R	600	1983 - 1987	489945		511532		465832
XL 600RM	600	1986 - 1986	524569	512638	511540		
Africa Twin XRV 650	650	1988 - 1989	524570		511540		
Bros NT 650	650	1988 - 1992	489940		499706	520922	465836
CB 650	650	1979 - 1981	524567		511538		
CB 650F	650	2014 - 2016	490331			520922	483849
CB 650FA	650	2014 - 2020	490331			520922	483849
CB 650R	650	2019 - 2023	490331			520922	483849
CBR 650F	650	2014 - 2016	490331			520922	483849
CBR 650FA	650	2014 - 2018	490331			520922	483849
CBR 650R	650	2019 - 2023	490331			520922	483849
Custom CB 650C	650	1980 - 1981	524567		511538		
Custom CB 650SC	650	1982 - 1982	524567		511538		
CX 650E	650	1983 - 1983	490558	512637	499702		465842
Deauville NT 650V	650	1998 - 2001	489940		499706	520922	465836
Deauville NT 650V	650	2002 - 2003	490331			520922	483849
Deauville NT 650V	650	2004 - 2005	490556			520922	490512
Dominator NX 650	650	1988 - 2002	489940		499706	520922	465836
FMX 650	650	2005 - 2008	489940		499706	520922	465836
GL 650D2	650	1984 - 1984	490558	512637	499702		465842
Hawk NT 650GT	650	1988 - 1991	489940		499706	520922	465836
Revere NTV 650	650	1988 - 1997	489940		499706	520922	465836
Rincon TRX 650FA	650	2003 - 2005	489948		499709	520924	
SLR 650	650	1997 - 1998	489940		499706	520922	465836
Transalp XL 650V	650	2000 - 2007	490330			520922	490511
Turbo CX 650T	650	1983 - 1983	490558	512637	499702		465842
Vigor FX 650	650	1999 - 2003	489940		499706	520922	465836
XR 650L	650	1993 - 2019	489940		499706	520922	465836
DN-01 680A	680	2008 - 2011	490556			520922	490512
Rubicon TRX 680FA	680	2006 - 2014	489948		499709	520924	
Big Red MUV 700	700	2009 - 2009	489946		499708	520922	465838
CTX 700	700	2014 - 2014	490330			520922	490511
CTX 700D	700	2014 - 2014	490330			520922	490511

MOTEUR

CYCLE

PNEUMATIQUE

ATELIER

ACCESSOIRES

ÉLECTRICITÉ

FILTRATION

FREINAGE

TRANSMISSION

Modèle	Cylindre	Année	FULBAT	FULBAT	Lithium	Réf.	
			Préconisation constructeur	Sans entretien acide			Sans entretien gel
CTX 700N	700	2014 - 2014	490330		520922	490511	
CTX 700ND	700	2014 - 2016	490330		520922	490511	
Deauville NT 700V	700	2006 - 2013	490556		520922	490512	
Deauville NT 700VA	700	2007 - 2015	490556		520922	490512	
Integra NC 700D	700	2012 - 2013	490330		520922	490511	
NC 700S	700	2012 - 2013	490330		520922	490511	
NC 700SA	700	2012 - 2013	490330		520922	490511	
NC 700X	700	2012 - 2014	490330		520922	490511	
NC 700XA	700	2012 - 2013	490330		520922	490511	
NC 700XD	700	2012 - 2014	490330		520922	490511	
Transalp XL 700V	700	2008 - 2013	490556		520922	490512	
Transalp XL 700VA	700	2008 - 2013	490556		520922	490512	
TRX 700XX	700	2008 - 2009	489940		499706	520922	465836
VF 700S	700	1984 - 1985	490558	512637	499702		465842
Africa Twin XRV 750	750	1990 - 1992	524570		511540		
Africa Twin XRV 750	750	1993 - 2003	489946		499708	520922	465838
Black Widow VT 750DC	750	2000 - 2004	490556			520922	490512
CB 750 Hornet R	750	2023 -	490331			520922	483849
CB 750F	750	1976 - 1984	490558	512637	499702		465842
CB 750F1	750	1977 - 1977	490558	512637	499702		465842
CB 750F2	750	1978 - 1978	490558	512637	499702		465842
CB 750K	750	1969 - 1981	490558	512637	499702		465842
CBR 750F	750	1987 - 1988	497358		511537		467893
CBX 750F	750	1984 - 1987	524569	512638	511540		
Custom CB 750C	750	1980 - 1981	490558	512637	499702		465842
Integra NC 750D	750	2014 - 2020	490556			520922	490512
Integra S NC 750D	750	2014 - 2020	490556			520922	490512
Interceptor VF 750F	750	1983 - 1985	524569	512638	511540		
NC 750 X ABS, DCT NC 750XAM	750	2021 - 2023	490330			520922	490511
NC 750S	750	2014 - 2016	490556			520922	490512
NC 750SA	750	2014 - 2020	490556			520922	490512
NC 750X	750	2014 - 2015	490556			520922	490512
NC 750X DCT	750	2021 - 2023	490330			520922	490511
NC 750XA	750	2014 - 2020	490556			520922	490512
NC 750XA DCT	750	2021 - 2023	490330			520922	490511
NC 750XD	750	2014 - 2020	490556			520922	490512
Nighthawk CB 750	750	1991 - 2003	512638		511540		
NM 4 Vultus NC 750J	750	2015 - 2019	490556			520922	490512
RVF 750R	750	1994 - 1998	489940		499706	520922	465836
Sabre VF 750S	750	1982 - 1982	490558	512637	499702		465842
Seven Fifty CB 750F2	750	1992 - 2003	524569	512638	511540		
Shadow Aero VT 750C	750	2009 - 2009	490556			520922	490512
Shadow Aero VT 750CA	750	2009 - 2009	490330			520922	490511
Shadow Aero VTC 750C	750	2018 - 2019	490556			520922	490512
Shadow Aero VTC 750CS	750	2018 - 2019	490556			520922	490512



Modèle	Cylindre	Année	FULBAT		YUASA		
			Préconisation constructeur	Sans entretien acide	Sans entretien gel	Lithium	Réf.
Shadow Phantom VT 750C2B	750	2011 - 2012	490556			520922	490512
Shadow Spirit VT 750C2	750	2007 - 2008	490556			520922	490512
Shadow Spirit VT 750C2B	750	2013 - 2016	490556			520922	490512
Shadow Spirit VT 750C2S	750	2010 - 2014	490556			520922	490512
Shadow Spirit VT 750DC	750	2007 - 2009	490556			520922	490512
Shadow VF 750C	750	1983 - 1983	524569	512638	511540		
Shadow VT 750C	750	1997 - 2003	489946		499708	520922	465838
Shadow VT 750C	750	2004 - 2007	490330			520922	490511
Shadow VT 750C	750	2008 - 2008	490556			520922	490512
Shadow VT 750C2	750	1997 - 2001	489946		499708	520922	465838
Shadow VT 750C2	750	2009 - 2014	490556			520922	490512
Shadow VT 750C2B	750	2010 - 2010	490556			520922	490512
Shadow VT 750CA	750	2004 - 2008	490330			520922	490511
Shadow VT 750CA	750	2012 - 2014	490556			520922	490512
Shadow VT 750CS	750	2010 - 2014	490556			520922	490512
VF 750C	750	1987 - 1987	524567		511538		
VF 750C	750	1993 - 2004	489943		499707	520922	465837
VF 750C2	750	1997 - 2000	489943		499707	520922	465837
VF 750CD	750	1995 - 1996	489943		499707	520922	465837
VFR 750F	750	1986 - 1997	489943		499707	520922	465837
VFR 750R	750	1988 - 1990	489940		499706	520922	465836
VT 750C	750	2010 - 2015	490556			520922	490512
VT 750S	750	2011 - 2011	490556			520922	490512
VT750RS VT 750S	750	2010 - 2010	490556			520922	490512
X-ADV ADV 750	750	2017 - 2020	490556			520922	490512
XLV 750R	750	1983 - 1988	524569	512638	511540		
Crossrunner VFR 800X	800	2015 - 2015	490330			520922	490511
Crossrunner VFR 800XA	800	2011 - 2019	490330			520922	490511
Pacific Coast PC 800	800	1989 - 1998	489943		499707	520922	465837
VFR 800	800	2002 - 2005	490330			520922	490511
VFR 800A	800	2002 - 2005	490330			520922	490511
VFR 800FA	800	2014 - 2019	490330			520922	490511
VFR 800Fi	800	1998 - 2001	489943		499707	520922	465837
VFR 800Fi	800	2002 - 2005	490330			520922	490511
VTEC VFR 800	800	2006 - 2009	490330			520922	490511
VTEC VFR 800A	800	2006 - 2013	490330			520922	490511
Bol d'Or CB 900F	900	1979 - 1981	490558	512637	499702		465842
CB 900F	900	1982 - 1983	490558	512637	499702		465842
Evolution Blade CBR 900	900	1999 - 1999	489940		499706	520922	465836
Fireblade CBR 900RR	900	1992 - 1999	489940		499706	520922	465836
Fireblade CBR 929RR	900	2000 - 2001	490331			520922	483849
Fireblade CBR 954RR	900	2002 - 2003	490331			520922	483849
Hornet CB 900F	900	2002 - 2007	490331			520922	483849
Africa Twin CRF 1000A	1000	2016 - 2017	490556			520922	490512
Africa Twin CRF 1000AL	1000	2016 - 2017	490556			520922	490512

MOTEUR

CYCLE

PNEUMATIQUE

ATELIER

ACCESSOIRES

ÉLECTRICITÉ

FILTRATION

FREINAGE

TRANSMISSION

Modèle	Cylindre	Année	FULBAT	FULBAT		Lithium	Réf.
			Préconisation constructeur	Sans entretien acide	Sans entretien gel		
Africa Twin CRF 1000D	1000	2016 - 2017	490556			520922	490512
Africa Twin CRF 1000DL	1000	2016 - 2017	490556			520922	490512
Africa Twin Replica CRF 1000A	1000	2017 - 2017	490556			520922	490512
Big One CB 1000F	1000	1993 - 1997	489943		499707	520922	465837
CB 1000R	1000	2009 - 2015	490331			520922	483849
CB 1000RA	1000	2009 - 2022	490331			520922	483849
CB 1000RA Black Edition	1000	2023 -	490331			520922	483849
CBF 1000	1000	2006 - 2012	490331			520922	483849
CBF 1000A	1000	2006 - 2010	490331			520922	483849
CBF 1000F	1000	2010 - 2015	490331			520922	483849
CBF 1000FA	1000	2010 - 2016	490331			520922	483849
CBF 1000FS	1000	2010 - 2013	490331			520922	483849
CBF 1000FT	1000	2010 - 2013	490331			520922	483849
CBF 1000S	1000	2007 - 2011	490331			520922	483849
CBF 1000T	1000	2007 - 2015	490331			520922	483849
CBR 1000F	1000	1987 - 1999		512637	499702		
CBR Fireblade 1000RA	1000	2009 - 2016	490331			520922	483849
CBR Fireblade 1000RA	1000	2017 - 2019	493802			520919	483662
CBR Fireblade 1000RR	1000	2004 - 2007	490331			520922	483849
CBR Fireblade 1000RR	1000	2008 - 2023	493802			520919	483662
CBR Fireblade 1000RR SP S	1000	2014 - 2016	493802			520919	483662
CBR Fireblade 1000RR SP SA	1000	2014 - 2016	493802			520919	483662
CBR Fireblade 1000RR SP SA TT Edition	1000	2016 - 2016	493802			520919	483662
CBR Fireblade 1000RR-R SP	1000	2020 - 2023	493802			520919	483662
CBX 1000	1000	1979 - 1982		489948	499709	520924	
Firestorm VTR 1000F	1000	1997 - 2000	489943		499707	520922	465837
Firestorm VTR 1000F	1000	2001 - 2006	490330			520922	490511
Goldwing GL 1000	1000	1975 - 1979		504082	511545	520924	
ProLink CBX 1000	1000	1980 - 1980		489948	499709	520924	
SP1 VTR 1000SP	1000	2000 - 2001	490330			520922	490511
SP2 VTR 1000SP	1000	2002 - 2006	490330			520922	490511
Varadero XL 1000V	1000	1999 - 2002	489946		499708	520922	465838
Varadero XL 1000V	1000	2003 - 2011	500868		513064		
Varadero XL 1000VA	1000	2004 - 2012	500868		513064		
Blackbird CBR 1100XX	1100	1997 - 2000	489943		499707	520922	465837
Blackbird CBR 1100XX	1100	2001 - 2008	490330			520922	490511
CB 1100 DCT CB1100NTADK	1100	2021 - 2023	490556			520922	490512
CB 1100 EX DCT CB1100CADK	1100	2021 - 2023	490556			520922	490512
CB 1100 RS DCT CB1100NADL	1100	2021 - 2023	490556			520922	490512
CB 1100A	1100	2013 - 2015	490556			520922	490512
CB 1100EX	1100	2014 - 2019	490556			520922	490512
CB 1100F	1100	1983 - 1983	490558	512637	499702		465842
CB 1100R	1100	1980 - 1985	490558	512637	499702		465842
CB 1100RS	1100	2017 - 2019	490556			520922	490512
CB 1100SA	1100	2014 - 2014	490556			520922	490512



Modèle	Cylindre	Année	FULBAT		FULBAT		YUASA
			Préconisation constructeur	Sans entretien acide	Sans entretien gel	Lithium	Réf.
CMX 1100 REBEL, DCT CMX1000AM, DM	1100	2021 - 2023	490556			520922	490512
GL 1100	1100	1980 - 1981		504082	511545	520924	
Goldwing Aspencade GL 1100	1100	1983 - 1983		504082	511545	520924	
Goldwing GL 1100	1100	1982 - 1982		504082	511545	520924	
NT 1100	1100	2022 - 2023	490556			520922	490512
Pan European ST 1100	1100	1990 - 2002	489946		499708	520922	465838
Pan European ST 1100A	1100	1992 - 2002	489946		499708	520922	465838
VT 1100C2	1100	2000 - 2005	489946		499708	520922	465838
XII CB 1100SF	1100	2000 - 2003	489943		499707	520922	465837
Crosstourer Highlander VFR 1200XD	1200	2013 - 2016	490556			520922	490512
Crosstourer VFR 1200XA	1200	2012 - 2019	490556			520922	490512
Crosstourer VFR 1200XD	1200	2012 - 2019	490556			520922	490512
DCT VFR 1200FAD	1200	2010 - 2017	490556			520922	490512
DCT VFR 1200FAD GT	1200	2014 - 2015	490556			520922	490512
Goldwing GL 1200A	1200	1984 - 1986		504082	511545	520924	
Goldwing GL 1200D	1200	1984 - 1986		504082	511545	520924	
VFR 1200FA	1200	2010 - 2016	490556			520922	490512
CB 1300F	1300	1998 - 2001	490556			520922	490512
CB 1300N	1300	2005 - 2009	490556			520922	490512
CB 1300NA	1300	2005 - 2009	490556			520922	490512
CB 1300S	1300	2005 - 2009	490556			520922	490512
CB 1300SA	1300	2005 - 2013	490556			520922	490512
CTX 1300	1300	2014 - 2014	490556			520922	490512
CTX 1300A	1300	2014 - 2016	490556			520922	490512
Pan European ST 1300	1300	2002 - 2009	490556			520922	490512
Pan European ST 1300A	1300	2002 - 2016	490556			520922	490512
Superfour CB 1300F	1300	2003 - 2009	490556			520922	490512
VT 1300CTA	1300	2011 - 2013	490556			520922	490512
VT 1300CX	1300	2010 - 2017	490556			520922	490512
VT 1300CXA	1300	2010 - 2019	490556			520922	490512
VTX 1300S	1300	2003 - 2008	489946		499708	520922	465838
X4 CB 1300DC	1300	1997 - 2000	489946		499708	520922	465838
Aspencade GL 1500A	1500	1991 - 2000		504082	511545	520924	
F6C GL 1500C	1500	1997 - 2003	489946		499708	520922	465838
Goldwing GL 1500	1500	1988 - 1990		504082	511545	520924	
Goldwing GL 1500SE	1500	1990 - 2000		504082	511545	520924	
Goldwing GL 1800	1800	2012 - 2017	499709			520924	
Goldwing GL 1800	1800	2001 - 2011	489948		499709	520924	
Goldwing GL 1800A	1800	2001 - 2005	489948		499709	520924	
Goldwing GL 1800B	1800	2018 - 2023	499709			520924	
Goldwing GL 1800BD	1800	2018 - 2023	499709			520924	
Goldwing GLF6BA 1800B	1800	2013 - 2017	499709			520924	
Goldwing GLF6CA 1800C	1800	2014 - 2017	499709			520924	
Goldwing Tour Airbag GL 1800DA	1800	2018 - 2023	499709			520924	

Modèle	Cylindre	Année	FULBAT	FULBAT	YUASA		Réf.
			Préconisation constructeur	Sans entretien acide	Sans entretien gel	Lithium	
Goldwing Tour GL 1800	1800	2018 - 2023	499709			520924	
Goldwing Tour GL 1800D	1800	2018 - 2023	499709			520924	
VTX 1800C	1800	2002 - 2004	489948		499709	520924	
VTX 1800C1	1800	2005 - 2007	489948		499709	520924	
VTX 1800F1	1800	2008 - 2008	489948		499709	520924	
HUSABERG							
FE 250e (4T)	250	2013 - 2014	489944		499703	520919	465835
TE 250 (2T)	250	2011 - 2013	489937		489939	520919	465833
TE 250 (2T)	250	2014 - 2014	489944		499703	520919	465835
TE 300 (2T)	300	2011 - 2013	489937		489939	520919	465833
TE 300 (2T)	300	2014 - 2014	489944		499703	520919	465835
FE 350e (4T)	350	2014 - 2014	489944		499703	520919	465835
TE 350	350	1996 - 1999	489940		499706	520922	465836
FE 400	400	2000 - 2002	489944		499703	520919	465835
FE 450	450	2013 - 2014	489944		499703	520919	465835
FE 450	450	2008 - 2012	493802			520919	483662
FE 450E	450	2003 - 2008	493802			520919	483662
FE 501	501	2000 - 2002	489944		499703	520919	465835
FE 501 (4T)	501	2013 - 2014	489944		499703	520919	465835
FE 501E	501	2003 - 2004	489944		499703	520919	465835
TE 501	501	1996 - 1999	489940		499706	520922	465836
FE 550E	550	2004 - 2008	493802			520919	483662
Supermoto FS 550E	550	2005 - 2007	493802			520919	483662
Enduro FE 600	600	2000 - 2003	489944		499703	520919	465835
FE 650E	650	2004 - 2005	493802			520919	483662
Supermotard FS 650	650	2004 - 2007	493802			520919	483662
Supermoto FS 650E	650	2005 - 2008	493802			520919	483662
HUSQVARNA							
SM 125S	125	2002 - 2013	489937		489939	520919	465833
SMS 4 125	125	2011 - 2014	489937		489939	520919	465833
Svartpilen 125	125	2021 - 2023	517780			520922	510621
WRE 125	125	1994 - 2013	489937		489939	520919	465833
FC 250 (4T)	250	2016 - 2018	512625				
FC 250 (4T)	250	2014 - 2015	489937		489939	520919	465833
FE 250 (4T)	250	2014 - 2016	489944		499703	520919	465835
TE 250 (2T)	250	2014 - 2016	489944		499703	520919	465835
TE 300 (2T)	300	2014 - 2016	489944		499703	520919	465835
FC 350	350	2016 - 2017	512625				
FC 350	350	2014 - 2015	489937		489939	520919	465833
FE 350	350	2014 - 2016	489944		499703	520919	465835
FX 350	350	2017 - 2017	512625				
TE 400	400	2001 - 2002	489946		499708	520922	465838
Svartpilen 401	401	2017 - 2022	517780			520922	510621
Vitpilen 401	401	2017 - 2023	517780			520922	510621



Modèle	Cylindre	Année	FULBAT		YUASA		
			Préconisation constructeur	Sans entretien acide	Sans entretien gel	Lithium	Réf.
Vitpilen Aero 401	401	2017 - 2017	517780			520922	510621
TE 410	410	2000 - 2001	489946		499708	520922	465838
TE 410	410	1997 - 1999	489937		489939	520919	465833
TE 410E	410	2000 - 2000	489946		499708	520922	465838
FC 450	450	2016 - 2017	512625				
FC 450	450	2014 - 2015	489937		489939	520919	465833
FE 450	450	2014 - 2016	489944		499703	520919	465835
FS 450	450	2016 - 2017	512625				
FS 450	450	2015 - 2015	489937		489939	520919	465833
FX 450	450	2017 - 2017	512625				
SM 450R	450	2003 - 2010	489937		489939	520919	465833
SM 450RR	450	2008 - 2010	489937		489939	520919	465833
SMR 450RR	450	2006 - 2007	489937		489939	520919	465833
TC 450	450	2002 - 2002	489937		489939	520919	465833
TE 450	450	2002 - 2005	489937		489939	520919	465833
TE 450	450	2006 - 2010	493802			520919	483662
FE 501	501	2019 - 2020	489939			520919	506882
FE 501	501	2014 - 2018	489944		499703	520919	465835
TE 510	510	2004 - 2010	493802			520919	483662
SM 610IE	610	2007 - 2009	489946		499708	520922	465838
SM 610S	610	2002 - 2006	489942		499705	520919	465840
Enduro 701	701	2016 - 2022	490331			520922	483849
Enduro 701LR	701	2020 - 2020	490331			520922	483849
Supermoto 701	701	2016 - 2023	490331			520922	483849
Svartpilen 701	701	2019 - 2022	490331			520922	483849
Vitpilen 701	701	2018 - 2022	490331			520922	483849
Nuda 900	900	2012 - 2013	489946		499708	520922	465838
Nuda R 900	900	2012 - 2013	489946		499708	520922	465838
Norden 901 Expedition	901	2023 -	517780			520922	510621
HYOSUNG							
Aquila GV 125	125	2001 - 2010	489940		499706	520922	465836
Bobber GV 125	125	2020 - 2022	489943		499707	520922	465837
Comet GT 125	125	2003 - 2010	489946		499708	520922	465838
GT 125R	125	2006 - 2015	489946		499708	520922	465838
GV 125C	125	2007 - 2015	489940		499706	520922	465836
Karion RT 125	125	2002 - 2015	489941		499704	520922	465834
Karion RX 125D	125	2007 - 2011	489941		499704	520922	465834
MS3 125	125	2007 - 2009	489940		499706	520922	465836
Naked GT 125	125	2003 - 2012	489946		499708	520922	465838
Naked GT 125i	125	2013 - 2015	489946		499708	520922	465838
RX 125	125	2001 - 2007	489941		499704	520922	465834
RX 125D	125	2008 - 2011	489941		499704	520922	465834
Supermoto XRX 125SM	125	2007 - 2008	489941		499704	520922	465834
Aquila GV 250	250	2004 - 2007	489940		499706	520922	465836

MOTEUR

CYCLE

PNEUMATIQUE

ATELIER

ACCESSOIRES

ÉLECTRICITÉ

FILTRATION

FREINAGE

TRANSMISSION

Modèle	Cylindre	Année	FULBAT	FULBAT	YUASA		
			Préconisation constructeur	Sans entretien acide	Sans entretien gel	Lithium	Réf.
Comet GT 250	250	2004 - 2010	489946		499708	520922	465838
GT 250iR	250	2008 - 2015	489946		499708	520922	465838
GT 250R	250	2004 - 2007	489946		499708	520922	465838
GV 250C	250	2008 - 2015	489940		499706	520922	465836
MS3 250i	250	2007 - 2009	489940		499706	520922	465836
Naked GT 250	250	2011 - 2012	489946		499708	520922	465838
Naked GT 250Pi	250	2013 - 2015	489946		499708	520922	465838
Sport GT 250R	250	2004 - 2008	489946		499708	520922	465838
Bobber GV 125	300	2020 - 2022	489943		499707	520922	465837
Quad Rapier TE 450	450	2006 - 2011	489940		499706	520922	465836
Aquila GV 650	650	2004 - 2006	489946		499708	520922	465838
Comet Naked GT 650	650	2004 - 2008	489946		499708	520922	465838
GT 650iR	650	2009 - 2018	489946		499708	520922	465838
GT 650R	650	2006 - 2008	489946		499708	520922	465838
GT 650S	650	2005 - 2008	489946		499708	520922	465838
GT 650X	650	2007 - 2007	489946		499708	520922	465838
GV 650i	650	2007 - 2015	489946		499708	520922	465838
Naked GT 650	650	2009 - 2011	489946		499708	520922	465838
Naked GT 650i	650	2012 - 2018	489946		499708	520922	465838
Deluxe ST 7	700	2012 - 2015	489946		499708	520922	465838
ST 7	700	2010 - 2015	489946		499708	520922	465838
INDIAN							
Scout Sixty 1000	1000	2016 - 2020	512638		511540		
Scout Sixty 1000	1000	2016 - 2021	512638		511540		
Scout 100th anniversary Edition 1130	1130	2020 - 2020	512637		499702		
Scout 100th anniversary Edition 1130	1130	2020 - 2020	512637		499702		
Scout 1130	1130	2015 - 2020	512638		511540		
Scout 1130	1130	2015 - 2021	512638		511540		
Scout Bobber 1130	1130	2018 - 2020	512637		499702		
Scout Bobber 1130	1130	2018 - 2020	512637		499702		
FTR FTR 1200	1200	2019 - 2022	499708			520922	510623
FTR Rally FTR 1200	1200	2020 - 2022	499708			520922	510623
FTR S FTR 1200 R Carbon	1200	2019 - 2022	499708			520922	510623
FTR S FTR 1200S	1200	2019 - 2022	499708			520922	510623
Challenger 1800	1800	2020 - 2022	489948		499709	520924	
Challenger Dark Horse 1800	1800	2020 - 2022	489948		499709	520924	
Challenger Limited 1800	1800	2020 - 2022	489948		499709	520924	
Pursuit Dark Horse 1800	1800	2022 - 2023	489948		499709	520924	
Chief 1811	1811	2022 - 2023	489948		499709	520924	
Chief Bobber 1811	1811	2022 - 2023	489948		499709	520924	
Chief Bobber Dark Horse 1811	1811	2016 - 2021	489948		499709	520924	
Chief Classic 1811	1811	2014 - 2018	489948		499709	520924	
Chief Dark Horse 1811	1811	2014 - 2020	489948		499709	520924	
Chief Vintage 1811	1811	2014 - 2019	489948		499709	520924	



Modèle	Cylindre	Année	FULBAT		YUASA		Réf.
			Préconisation constructeur	Sans entretien acide	Sans entretien gel	Lithium	
Chieftain 1811	1811	2014 - 2021	489948		499709	520924	
Chieftain Classic 1811	1811	2018 - 2020	489948		499709	520924	
Chieftain Dark Horse 1811	1811	2016 - 2021	489948		499709	520924	
Chieftain Elite 1811	1811	2017 - 2021	489948		499709	520924	
Chieftain Limited 1811	1811	2017 - 2021	489948		499709	520924	
Indian Chief Dark Horse 1811	1811	2020 - 2020	489948		499709	520924	
Indian Springfield 1811	1811	2020 - 2021	489948		499709	520924	
Indian Vintage 1811	1811	2020 - 2021	489948		499709	520924	
Roadmaster 1811	1811	2015 - 2021	489948		499709	520924	
Roadmaster Classic 1811	1811	2017 - 2018	489948		499709	520924	
Roadmaster Dark Horse 1811	1811	2019 - 2021	489948		499709	520924	
Roadmaster Elite 1811	1811	2017 - 2020	489948		499709	520924	
Roadmaster Limited 1811	1811	2020 - 2021	489948		499709	520924	
Springfield 1811	1811	2016 - 2020	489948		499709	520924	
Springfield 1811	1811	2016 - 2020	489948		499709	520924	
Springfield Dark Horse 1811	1811	2018 - 2021	489948		499709	520924	
Chief Dark Horse 1890	1890	2022 - 2023	489948		499709	520924	
Chief Dark Horse 1890	1890	2022 - 2023	489948		499709	520924	
Chief Bobber Dark Horse 1890	1890	2022 - 2023	489948		499709	520924	
Chieftain Dark Horse 1890	1890	2022 - 2023	489948		499709	520924	
Chieftain Elite 1890	1890	2022 - 2023	489948		499709	520924	
Chieftain Elite 1890	1890	2022 - 2023	489948		499709	520924	
Chieftain Limited 1890	1890	2022 - 2023	489948		499709	520924	
Roadmaster 1890	1890	2022 - 2023	489948		499709	520924	
Roadmaster Dark Horse 1890	1890	2022 - 2023	489948		499709	520924	
Roadmaster Limited 1890	1890	2022 - 2023	489948		499709	520924	
Springfield 1890	1890	2022 - 2023	489948		499709	520924	
Springfield Dark Horse 1890	1890	2022 - 2023	489948		499709	520924	
Super Chief (Limited) 1890	1890	2022 - 2023	489948		499709	520924	
Super Chief 1890	1890	2022 - 2023	489948		499709	520924	
ITALJET							
Dragster 125LC	125	1999 - 2012	497358		511537		467893
Formula 125LC	125	1996 - 2003	489938	526367	499700		462573
Millennium M 125LC	125	2000 - 2004	489941		499704	520922	465834
Torpedo 125	125	2007 - 2008	489938	526367	499700		462573
Millennium M 150LC	150	2000 - 2004	489941		499704	520922	465834
Dragster 180LC	180	1999 - 2012	497358		511537		467893
KAWASAKI							
BR 125 Z 125	125	2016 - 2017	489937		489939	520919	465833
BR 125 Z 125PRO	125	2016 - 2020	489937		489939	520919	465833
BR 125 Z 125PRO SE	125	2018 - 2020	489937		489939	520919	465833
D-Tracker KLX 125	125	2010 - 2014	489942		499705	520919	465840
Eliminator BN 125	125	1998 - 2009	489938	526367	499700		462573
KDX 125	125	1990 - 1999	489945		511532		465832
KH 125	125	1981 - 1986	512639		517777		

MOTEUR

CYCLE

PNEUMATIQUE

ATELIER

ACCESSOIRES

ÉLECTRICITÉ

FILTRATION

FREINAGE

TRANSMISSION

Modèle	Cylindre	Année	FULBAT	FULBAT	Lithium	Réf.
			Préconisation constructeur	Sans entretien acide		
KH 125	125	1987 - 1990	490557		511532	467892
KLX 125	125	2003 - 2016	489942		499705	465840
KMX 125	125	1986 - 2002	489949 489936		499699	462567 483973 510611 512772
NINJA 125	125	2019 - 2023	489941		499704	520919
SC125 J 125	125	2016 - 2020	490561		517780	465834
SC125 J 125SE	125	2016 - 2020	490561		517780	472408 481623
Z 125	125	2019 - 2023	489941		499704	520922
KLX 140R, L, F	140	2022 - 2023	499705			465834
KLF 185	185	1987 - 1987			511537	510615
KLT 200	200	1981 - 1984			511537	
KMX 200	200	1988 - 1992	489949 489936		499699	520919
KLF 220	220	1992 - 2002	501411		513059	
KLX 230	230	2020 - 2021	489941		499704	520922
Balius ZR 250	250	1991 - 2002	489942		499705	520919
Bayou KLF 250	250	2003 - 2005	501411		513059	
BJ 250	250	2002 - 2003	489940		499706	520922
BR 250 Z 250SL	250	2015 - 2017	489940		499706	520922
BX 250 Ninja Z 250SL	250	2015 - 2016	489940		499706	520922
D-Tracker KLX 250	250	1998 - 2003	489942		499705	520919
EL 250	250	1991 - 1999	489942		499705	520919
Estrella BJ 250	250	1992 - 1999	489940		499706	520922
Estrella Custom BJ 250	250	1996 - 2002	489940		499706	520922
Estrella RS BJ 250	250	1999 - 2002	489940		499706	520922
Estrella RS Custom BJ 250	250	1996 - 1999	489940		499706	520922
GPX 250R	250	1994 - 1995	489942		499705	520919
KH 250	250	1977 - 1977	493810		513055	
KL 250 KLR 250	250	1985 - 2005			499699	520919
KLE 250	250	1995 - 2001	489942		499705	520919
KLX 250	250	1994 - 2019	489942		499705	520919
KLX 250S	250	2006 - 2014	489942		499705	520919
KR-1 KR 250	250	1989 - 1989	489949 489936		499699	520919
KR-IS KR 250	250	1990 - 1991	489949 489936		499699	520919
Ninja EX 250R	250	2008 - 2012	489940		499706	520922
Prairie KLT 250	250	1984 - 1985			511537	
Prairie KLT 250	250	1983 - 1983	524567		511538	
Scorpion ER 250	250	1983 - 1988	500869			
Super Sherpa KL 250	250	2000 - 2010	489942		499705	520919
ZZR 250	250	1994 - 2003	489942		499705	520919
Bayou KLF 300	300	1988 - 2005	501411		513059	



Modèle	Cylindre	Année	FULBAT		YUASA		Réf.
			Préconisation constructeur	Sans entretien acide	Sans entretien gel	Lithium	
Bayou KLF 300	300	1986 - 1987			513060	520924	
Brute Force KVF 300	300	2012 - 2017	489943		499707	520922	
ER 300 Ninja Z 300	300	2015 - 2016	489940		499706	520922	
ER 300 Z 300	300	2015 - 2016	489940		499706	520922	
J 300	300	2014 - 2020	490561		517780	520922	
KFX 300 KEF 300	300	2004 - 2004	501411		513059		
Lakota Sport KEF 300	300	1995 - 2003	501411		513059		
Mule 500 KAF 300	300	2007 - 2007	501411		513059		
Ninja EX 300	300	2013 - 2016	489940		499706	520922	
Ninja Special Edition EX 300	300	2014 - 2016	489940		499706	520922	
Prairie KVF 300	300	1999 - 2002	501411		513059		
Versys-X KLE 300	300	2017 - 2020	489940		499706	520922	
KVF 360	360	2003 - 2013	501411		513059		
Bayou KLF 400	400	1993 - 1999			513060	520924	
KFX400 KSF 400	400	2003 - 2006	489940		499706	520922	
KLX 400R	400	2003 - 2004	491434			520921	
KLX 400SR	400	2003 - 2004	491434			520921	
Mule 600 KAF 400	400	2006 - 2014	501411		513059		
Mule 610 KAF 400	400	2006 - 2014	501411		513059		
Ninja EX 400	400	2018 - 2023	489940		499706	520922	
Prairie KVF 400	400	1999 - 2002	501411		513059		
Prairie KVF 400	400	1997 - 1998			513060	520924	
Xanthus ZR 400	400	1992 - 1995	489940		499706	520922	
Z 400	400	1978 - 1980	524567		511538		
Z 400	400	2019 - 2023	489940		499706	520922	
Z400 ER 400	400	2019 - 2023	489940		499706	520922	
Z400F2 ZX 400	400	1991 - 1994	524567		511538		
Zephyr ZR 400	400	1997 - 2001	489943		499707	520922	
ZR400 ZRX 400	400	1994 - 1996	489940		499706	520922	
ZX400 FX 400R	400	1986 - 1988	524567		511538		
ZX400 GPZ 400R	400	1985 - 1987	524567		511538		
ZX400 ZRX 400	400	1998 - 2001	489940		499706	520922	
ZXR 400	400	1989 - 1990	524567		511538		
ZXR 400	400	1991 - 1999	489940		499706	520922	
ZZR 400	400	1993 - 1999	489943		499707	520922	
Z 440	440	1980 - 1983	524567		511538		
Z 440LTD	440	1979 - 1984	524567		511538		
EN 450LTD	450	1985 - 1990	524567		511538		
KFX 450R	450	2008 - 2014	489942		499705	520919	
KLX 450R	450	2007 - 2022	493802			520919	483662
Mule 1000 KAF 450	450	1982 - 1982			513060	520924	
EN 500	500	1990 - 1996	524567		511538		
EN 500	500	1996 - 2009	491025		499701		462574
ER500 ER 5	500	1997 - 2007	489943		499707	520922	465837
EX 500 GPZ 500S	500	1987 - 2004	490558	512637	499702		465842

MOTEUR

CYCLE

PNEUMATIQUE

ATELIER

ACCESSOIRES

ÉLECTRICITÉ

FILTRATION

FREINAGE

TRANSMISSION

Modèle	Cylindre	Année	FULBAT		FULBAT		YUASA
			Préconisation constructeur	Sans entretien acide	Sans entretien gel	Lithium	Réf.
KH 500	500	1976 - 1976	500869				
KL500 KLR 500	500	1987 - 1989	490558	512637	499702		465842
KLE 500	500	1991 - 2007	489943		499707	520922	465837
Mach 3 H1 500	500	1969 - 1972	489938	526367	499700		462573
Vulcan LTD VN 500	500	2002 - 2002	491025		499701		462574
Z 500	500	1979 - 1981	524567		511538		
ZX500 GPX 500R	500	1988 - 1990	489943		499707	520922	465837
ZX500 ZZR 500	500	1990 - 1992	524567		511538		
Mule 2010 KAF 540	540	-			513060	520924	
Mule 2020 KAF 540	540	-			513060	520924	
Mule 2030 KAF 540	540	-			513060	520924	
GPZ 550	550	1981 - 1983	524567		511538		
KZ550 Z 550	550	1980 - 1982	524567		511538		
Z 550	550	1981 - 1982	524567		511538		
Z 550LTD	550	1980 - 1984	524567		511538		
Z550 GT 550	550	1983 - 1994	524567		511538		
Z550F ZR 550	550	1983 - 1984	524567		511538		
Zephyr ZR 550	550	1990 - 1993	524567		511538		
Zephyr ZR 550	550	1994 - 1999	489943		499707	520922	465837
ZX 550 GPZ 550	550	1984 - 1988	524567		511538		
Eliminator ZL 600	600	1995 - 1997	524567		511538		
KLR 600	600	1985 - 1995	490558	512637	499702		465842
ZX 600 GPX 600R	600	1988 - 1997	524567		511538		
ZX 600 GPZ 600R	600	1985 - 1989	524567		511538		
ZX 6R	600	1995 - 1997	489943		499707	520922	465837
ZX 6R	600	1998 - 2016	489940		499706	520922	465836
ZX 6RR	600	2003 - 2007	489940		499706	520922	465836
ZZR 600	600	1990 - 1993	524567		511538		
ZZR 600	600	1993 - 2005	489943		499707	520922	465837
ZZR 600	600	2006 - 2007	489940		499706	520922	465836
Mule 2500 KAF 620	620	2007 - 2007			513060	520924	
Mule 2510 KAF 620	620	2007 - 2007			513060	520924	
Mule 2520 KAF 620	620	2007 - 2007			513060	520924	
Mule 3000 KAF 620	620	2007 - 2007	489948		499709	520924	
Mule 3010 KAF 620	620	2004 - 2007	489948		499709	520924	
Mule 3020 KAF 620	620	2007 - 2007	489948		499709	520924	
Mule 4000 KAF 620	620	2009 - 2017			517782		
Mule 4010 Hardwood Green KAF 620	620	2009 - 2012			517782		
Mule 4010 KAF 620	620	2009 - 2017			517782		
ZX636 30th Anniversary Edition ZX 6R	636	2015 - 2015	489940		499706	520922	465836
ZX636 Special Edition ZX 6R	636	2016 - 2020	489940		499706	520922	465836
ZX636 ZX 6R	636	2002 - 2020	489940		499706	520922	465836
Brute Force Hardwoods Green KVF 650	650	2005 - 2009	489946		499708	520922	465838
Brute Force KVF 650	650	2005 - 2014	489946		499708	520922	465838
Custom Z 650	650	1977 - 1979	500870		511537		



Modèle	Cylindre	Année	FULBAT		YUASA		
			Préconisation constructeur	Sans entretien acide	Sans entretien gel	Lithium	Réf.
EJ650 W 650	650	2006 - 2006	489943		499707	520922	465837
EJ650 W 650	650	1999 - 2005	489946		499708	520922	465838
ER650 ER 6N	650	2012 - 2016	490561		517780	520922	472408 481623
ER650 ER 6N	650	2006 - 2011	489943		499707	520922	465837
EX650 ER 6F	650	2012 - 2016	490561		517780	520922	472408 481623
EX650 ER 6F	650	2005 - 2011	489943		499707	520922	465837
EX650 NINJA 650	650	2017 - 2023	490331			520922	483849
KL650 KLR 650	650	1987 - 2014	490558	512637	499702		465842
KLX 650	650	1993 - 2002	489940		499706	520922	465836
Prairie KVF 650	650	2002 - 2003	489946		499708	520922	465838
Tengai KL 650	650	1989 - 1992	490558	512637	499702		465842
Versys KLE 650	650	2007 - 2021	489943		499707	520922	465837
Versys KLE 650	650	2017 - 2023	489943		499707	520922	465837
Vulcan S Speciale Edition EN 650	650	2017 - 2023	490331			520922	483849
Vulcan S EN 650	650	2015 - 2023	490331			520922	483849
Z 650	650	1977 - 1983	500870		511537		
Z 650 ER 650	650	2017 - 2023	490331			520922	483849
Z 650 RS	650	2022 - 2023	490331			520922	483849
Z 650SR	650	1979 - 1980	500870		511537		
KSV700 V-Force KFX 700	700	2004 - 2011	489946		499708	520922	465838
Prairie KVF 700	700	2004 - 2008	489946		499708	520922	465838
Team Green KVF 700	700	2005 - 2005	489946		499708	520922	465838
Vulcan VN 700	700	1985 - 1985	490558	512637	499702		465842
Z 700LTD	700	1984 - 1984	524567		511538		
ZN 700LTD	700	1984 - 1985	490558	512637	499702		465842
Black Edition Z 750R	750	2012 - 2012	489940		499706	520922	465836
Brute Force KVF 750	750	2004 - 2014	489946		499708	520922	465838
GPZ 750	750	1982 - 1982	524567		511538		
GPZ 750R	750	1985 - 1987	490558	512637	499702		465842
KZ750 GT 750	750	1982 - 1996	490558	512637	499702		465842
KZ750 Z 750	750	1980 - 1984	524567		511538		
KZ750 Z 750	750	1977 - 1979	490558	512637	499702		465842
Mach IV KH 750H2	750	1972 - 1975	493811		513056		
Teryx 4 KRT 750	750	2012 - 2013			517782		
Teryx Fi KRF 750	750	2010 - 2013			517782		
Teryx KRF 750	750	2008 - 2009			517782		
Turbo GPZ 750	750	1983 - 1987	490558	512637	499702		465842
Unitrak GPZ 750X	750	1983 - 1987	490558	512637	499702		465842
Vulcan VN 750	750	1986 - 2006	490558	512637	499702		465842
Z 750LTD	750	1980 - 1982	524567		511538		
Z 750R	750	2011 - 2012	489940		499706	520922	465836
Z 750S	750	2005 - 2007	489940		499706	520922	465836
Zephyr ZR 750	750	1991 - 1998	489943		499707	520922	465837

Modèle	Cylindre	Année	FULBAT	FULBAT	Lithium	Réf.
			Préconisation constructeur	Sans entretien acide		
ZR 750 Z 750	750	2004 - 2013	489940		499706	520922 465836
ZR 750 ZR 7	750	1999 - 2004	489943		499707	520922 465837
ZR 750 ZR 7S	750	2001 - 2005	489943		499707	520922 465837
ZX 750 GPX 750R	750	1987 - 1990	490558	512637	499702	465842
ZX750 ZX 7R	750	1996 - 2003	489943		499707	520922 465837
ZX750 ZX 7RR	750	1996 - 1999	489940		499706	520922 465836
ZX750 ZXR 750	750	1990 - 1990	491025		499701	462574
ZX750 ZXR 750	750	1989 - 1989	490558	512637	499702	465842
ZX750 ZXR 750	750	1991 - 1995	489943		499707	520922 465837
ZXR 750R	750	1992 - 1995	489943		499707	520922 465837
Classic VN 800	800	2004 - 2005	489943		499707	520922 465837
Classic VN 800	800	1996 - 2006	489946		499708	520922 465838
Drifter VN 800	800	2004 - 2006	489943		499707	520922 465837
Drifter VN 800	800	1999 - 2003	489946		499708	520922 465838
EJ800 Caf, Racer W 800	800	2019 - 2021	489943		499707	520922 465837
EJ800 Cafe Style W 800	800	2011 - 2011	489943		499707	520922 465837
EJ800 Special Edition W 800	800	2012 - 2014	489943		499707	520922 465837
EJ800 Street W 800	800	2019 - 2021	489943		499707	520922 465837
EJ800 W 800	800	2011 - 2023	489943		499707	520922 465837
Teryx 4 KRT 800	800	2014 - 2014			517782	
Teryx KRF 800	800	2014 - 2014			517782	
VN 800	800	1995 - 2005	489946		499708	520922 465838
ZR800 Special Edition Z 800e	800	2016 - 2016	489940		499706	520922 465836
ZR800 Z 800	800	2013 - 2016	489940		499706	520922 465836
ZR800 Z 800e	800	2013 - 2016	489940		499706	520922 465836
Cafe Z 900RS	900	2019 - 2020	489940		499706	520922 465836
Classic LT VN 900	900	2006 - 2020	489943		499707	520922 465837
Classic LT VN 900	900	2015 - 2015	490556			520922 490512
Classic Special Edition VN 900	900	2011 - 2016	489943		499707	520922 465837
Classic VN 900	900	2006 - 2020	489943		499707	520922 465837
Custom VN 900	900	2007 - 2020	489943		499707	520922 465837
Eliminator ZL 900	900	1985 - 1986	490558	512637	499702	465842
GPZ 900R	900	1984 - 1996	490558	512637	499702	465842
Z 900	900	1977 - 1977	500870		511537	
Z 900	900	1974 - 1976	490558	512637	499702	465842
Z 900RS	900	2018 - 2023	489940		499706	520922 465836
Z 900RS SE Z 900RS	900	2021 - 2023	489940		499706	520922 465836
ZR900 Z 900	900	2017 - 2022	489940		499706	520922 465836
ZX900 ZX 9R	900	1994 - 1997	489943		499707	520922 465837
ZX900 ZX 9R	900	1998 - 2004	489940		499706	520922 465836
GPZ 1000RX	1000	1986 - 1988	490558	512637	499702	465842
LVI1000 KLV 1000	1000	2004 - 2005	489946		499708	520922 465838
MK2 Z 1000	1000	1979 - 1980	490558	512637	499702	465842
Versys KLZ 1000	1000	2012 - 2023	489940		499706	520922 465836



Modèle	Cylindre	Année	FULBAT		YUASA		Réf.
			Préconisation constructeur	Sans entretien acide	Sans entretien gel	Lithium	
Versys S KLZ 1000	1000	2021 - 2023	489940		499706	520922	465836
Versys SE KLZ 1000	1000	2019 - 2023	489940		499706	520922	465836
Z 1000	1000	1977 - 1980	490558	512637	499702		465842
Z 1000	1000	1981 - 1983		489948	499709	520924	
Z 1000LTD	1000	1981 - 1983		489948	499709	520924	
Z 1000R2	1000	1983 - 1983		489948	499709	520924	
Z 1000ST	1000	1979 - 1982			499709	520924	
Z 1000ZIR	1000	1978 - 1979	490558	512637	499702		465842
Z H2 ZR 1000K	1000	2020 - 2021	490331			520922	483849
ZG 1000 GTR 1000	1000	1986 - 2006		489948	499709	520924	
ZL 1000	1000	1987 - 1988	490558	512637	499702		465842
ZR 1000 Z 1000	1000	2014 - 2016	490561		517780	520922	472408 481623
ZR 1000 Z 1000	1000	2003 - 2020	489940		499706	520922	465836
ZR 1000 Z 1000R	1000	2017 - 2021	489940		499706	520922	465836
ZX 1000 30th Anniversary Edition ZX 10R	1000	2015 - 2015	490331			520922	483849
ZX 1000 30th Anniversary Edition ZX 10R	1000	2015 - 2015	493802			520919	483662
ZX 1000 ZX 10	1000	1988 - 1990	490558	512637	499702		465842
ZX 1000 ZX 10R	1000	2004 - 2010			493803	520923	
ZX 1000 ZX 10R	1000	2011 - 2018	490331			520922	483849
ZX 1000 ZX 10R	1000	2011 - 2015	493802			520919	483662
ZX 1000 ZX 10R SE	1000	2018 - 2021	490331			520922	483849
ZX 1000 ZX 10RR	1000	2017 - 2021	490331			520922	483849
ZX1000 H2 1000SX	1000	2018 - 2020	490331			520922	483849
ZX1000 KRT Edition ZX 10R	1000	2019 - 2020	490331			520922	483849
ZX1000 KRT Replica ZX 10R	1000	2016 - 2018	490331			520922	483849
ZX1000 Ninja H2 1000	1000	2015 - 2023	490331			520922	483849
ZX1000 Ninja H2 1000	1000	2015 - 2023	490331			520922	483849
ZX1000 Ninja H2 1000R	1000	2015 - 2023	490331			520922	483849
ZX1000 Ninja H2 1000SX SE	1000	2018 - 2023	490331			520922	483849
ZX1000 Winter Test Edition ZX 10R	1000	2016 - 2016	490331			520922	483849
ZX1000 Z 1000SX	1000	2014 - 2016	490561		517780	520922	472408 481623
ZX1000 Z 1000SX	1000	2011 - 2021	489940		499706	520922	465836
ZX1000 ZX 10R	1000	2016 - 2016	490331			520922	483849
GPZ 1100	1100	1982 - 1983			499709	520924	
GPZ 1100	1100	1995 - 1999	489946		499708	520922	465838
GPZ 1100X	1100	1983 - 1985			499709	520924	
Z 1100	1100	1981 - 1983			499709	520924	
Zephyr ZR 1100	1100	1992 - 1997	490560		517782		478136
ZR 1100 ZRX 1100	1100	1997 - 2000	489946		499708	520922	465838
ZX 1100 ZZR 1100	1100	1990 - 1992	490558	512637	499702		465842
ZX 1100 ZZR 1100	1100	1993 - 2001	489946		499708	520922	465838
ZR 1200 ZRX 1200R	1200	2001 - 2008	489946		499708	520922	465838
ZR 1200 ZRX 1200S	1200	2001 - 2007	489946		499708	520922	465838

Modèle	Cylindre	Année	FULBAT	FULBAT		Lithium	Réf.
			Préconisation constructeur	Sans entretien acide	Sans entretien gel		
ZX 12R	1200	2000 - 2006	489946		499708	520922	465838
ZX1200 ZZR 1200	1200	2002 - 2005	489946		499708	520922	465838
Z 1300	1300	1979 - 1983		504082	511545	520924	
ZG 1300	1300	1984 - 1989		504082	511545	520924	
Performance Sport ZZR 1400	1400	2016 - 2019	489946		499708	520922	465838
ZG 1400 GTR 1400	1400	2008 - 2015	489946		499708	520922	465838
ZG 1400 GTR 1400	1400	2016 - 2018	490556			520922	490512
ZX 1400 Special Edition ZZR 1400	1400	2015 - 2015	489946		499708	520922	465838
ZX 1400 ZZR 1400	1400	2006 - 2020	489946		499708	520922	465838
Classic Fi VN 1500	1500	2000 - 2004	490560		517782		478136
Classic Tourer Fi VN 1500	1500	2000 - 2004	490560		517782		478136
Classic Tourer VN 1500	1500	1998 - 1999	490560		517782		478136
Classic VN 1500	1500	1996 - 2008	490560		517782		478136
Drifter VN 1500	1500	1999 - 2005	490560		517782		478136
Mean Streak VN 1500	1500	2002 - 2004	490560		517782		478136
Nomad VN 1500	1500	1999 - 2001	490560		517782		478136
VN 1500	1500	1987 - 2006		504082	511545	520924	
VN 15SE	1500	1987 - 1992		504082	511545	520924	
Classic Tourer VN 1600	1600	2005 - 2008	490560		517782		478136
Classic VN 1600	1600	2003 - 2008	490560		517782		478136
Mean Streak VN 1600	1600	2004 - 2008	490560		517782		478136
Classic Tourer VN 1700	1700	2009 - 2015	490560		517782		478136
Classic VN 1700	1700	2009 - 2014	490560		517782		478136
Vaquero VN 1700	1700	2019 - 2020	490560		517782		478136
Voyager Custom VN 1700	1700	2011 - 2014	490560		517782		478136
Voyager VN 1700	1700	2009 - 2020	490560		517782		478136
Vulcan Nomad VN 1700	1700	2016 - 2016	490560		517782		478136
Classic VN 2000	2000	2008 - 2009	490560		517782		478136
VN 2000	2000	2004 - 2007	490560		517782		478136
KEEWAY							
Cityblade 125	125	2013 - 2019	489941		499704	520922	465834
F-Act 125	125	2007 - 2011	489942		499705	520919	465840
Focus 125	125	2006 - 2007	489942		499705	520919	465840
Logik 125	125	2013 - 2019	489942		499705	520919	465840
Matrix 125	125	2006 - 2010	489942		499705	520919	465840
RKS 125	125	2010 - 2014	493812				462571
RKV 125	125	2016 - 2019	493812		513057		462571
Silverblade 125i	125	2013 - 2015	489940		499706	520922	465836
Speed 125	125	2007 - 2012	489938	526367	499700		462573
Superlight 125	125	2007 - 2019	489941		499704	520922	465834
Target 125	125	2013 - 2015	489944		499703	520919	465835
TX 125SM	125	2010 - 2014	489942		499705	520919	465840
Cityblade 150	150	2013 - 2015	489941		499704	520922	465834
Logik 150	150	2013 - 2015	489942		499705	520919	465840



Modèle	Cylindre	Année	FULBAT		YUASA		Réf.
			Préconisation constructeur	Sans entretien acide	Sans entretien gel	Lithium	
RKS 150	150	2012 - 2015	493812				462571
Superlight 150	150	2007 - 2012	489941		499704	520922	465834
RKS 200	200	2012 - 2014	493812				462571
TX 200	200	2013 - 2014	489942		499705	520919	465840
Blackster 250	250	2014 - 2015	489938	526367	499700		462573
Silverblade 250i	250	2013 - 2014	489940		499706	520922	465836
KREIDLER							
Enduro 125DD	125	2008 - 2011	489940		499706	520922	465836
Enduro 4T 125	125	2014 - 2015	489940		499706	520922	465836
Insignio 4T 125	125	2014 - 2015	489940		499706	520922	465836
Street 125DD	125	2008 - 2011	489940		499706	520922	465836
Supermoto 125DD	125	2008 - 2011	489940		499706	520922	465836
Supermoto 4T 125	125	2014 - 2015	489940		499706	520922	465836
Insignio 4T 250	250	2014 - 2015	489940		499706	520922	465836
KTM							
Duke 125	125	2017 - 2023	489940		499706	520922	465836
Duke 125	125	2017 - 2023	489940		499706	520922	465836
Duke 125	125	2011 - 2016	493802			520919	483662
EXE 125	125	2000 - 2001	489937		489939	520919	465833
LC2 125	125	1996 - 1998	489937		489939	520919	465833
RC 125	125	2014 - 2023	489940		499706	520922	465836
Sting 125	125	1997 - 1998	489937		489939	520919	465833
Supermoto SM 125	125	2000 - 2001	489937		489939	520919	465833
Duke 200	200	2012 - 2020	489940		499706	520922	465836
EXC 200	200	2013 - 2016	489937		489939	520919	465833
EXC-GS 200	200	2002 - 2002	489937		489939	520919	465833
RC 200	200	2014 - 2020	489940		499706	520922	465836
Champion Edition EXC-F 250	250	2010 - 2010	489944		499703	520919	465835
Duke 250	250	2015 - 2020	489940		499706	520922	465836
E-Starter EXC 250	250	2010 - 2010	489937		489939	520919	465833
EXC 250	250	2011 - 2016	489937		489939	520919	465833
EXC Racing EXC-F 250	250	2002 - 2006	489944		499703	520919	465835
EXC-F 250	250	2008 - 2016	489937		489939	520919	465833
EXC-F 250	250	2006 - 2011	489944		499703	520919	465835
Factory Edition EXC-F 250	250	2015 - 2015	489937		489939	520919	465833
Factory Edition EXC-F 250	250	2011 - 2011	489944		499703	520919	465835
Factory EXC 250	250	2005 - 2005	489944		499703	520919	465835
Racing EXC 250	250	2001 - 2006	489944		499703	520919	465835
Racing Six Days EXC 250	250	2003 - 2003	489944		499703	520919	465835
Six Days EXC 250	250	2011 - 2016	489937		489939	520919	465833
Six Days EXC-F 250	250	2012 - 2016	489937		489939	520919	465833
Six Days EXC-F 250	250	2007 - 2011	489944		499703	520919	465835
SX-F 250	250	2016 - 2017	512625				
SX-F 250	250	2012 - 2015	489937		489939	520919	465833
XC 250	250	2011 - 2017	489937		489939	520919	465833

MOTEUR

CYCLE

PNEUMATIQUE

ATELIER

ACCESSOIRES

ÉLECTRICITÉ

FILTRATION

FREINAGE

TRANSMISSION

Modèle	Cylindre	Année	FULBAT	FULBAT	YUASA		Réf.
			Préconisation constructeur	Sans entretien acide	Sans entretien gel	Lithium	
XC 250	250	2014 - 2014	489944		499703	520919	465835
XC-F 250	250	2011 - 2015	489944		499703	520919	465835
2T XC 300	300	2011 - 2017	489937		489939	520919	465833
2T XC 300	300	2014 - 2014	489944		499703	520919	465835
2T XC 300TPI	300	2018 - 2020	489937		489939	520919	465833
EXC 300	300	2008 - 2016	489937		489939	520919	465833
EXC-E 300	300	2007 - 2007	489937		489939	520919	465833
Factory Edition EXC 300	300	2011 - 2011	489937		489939	520919	465833
Six Days EXC 300	300	2009 - 2016	489937		489939	520919	465833
Six Days EXC-E 300	300	2008 - 2011	489937		489939	520919	465833
EXC-F 350	350	2011 - 2016	489937		489939	520919	465833
Freeride 350F	350	2012 - 2016	489944		499703	520919	465835
Six Days EXC-F 350	350	2012 - 2016	489937		489939	520919	465833
SX-F 350	350	2016 - 2017	512625				
SX-F 350	350	2010 - 2015	489937		489939	520919	465833
XC-F 350	350	2012 - 2015	489944		499703	520919	465835
390 Adventure	390	2020 - 2023	489940		499706	520922	465836
Duke 390	390	2013 - 2023	489940		499706	520922	465836
RC 390	390	2014 - 2023	489940		499706	520922	465836
RC 390R	390	2018 - 2020	489940		499706	520922	465836
Enduro EGS 400	400	1999 - 1999	489940		499706	520922	465836
Enduro EGS-E 400LC4	400	1997 - 1997	489940		499706	520922	465836
Enduro LC4 R 400	400	1999 - 1999	489940		499706	520922	465836
EXC 400	400	2009 - 2011	489944		499703	520919	465835
Factory Edition EXC 400	400	2011 - 2011	489944		499703	520919	465835
Factory Racing EXC 400	400	2005 - 2007	489944		499703	520919	465835
LC4 400	400	1998 - 1999	489940		499706	520922	465836
LC4-E 400	400	2000 - 2001	489940		499706	520922	465836
LSE 400	400	1996 - 1997	489940		499706	520922	465836
Racing EXC 400	400	2000 - 2007	489944		499703	520919	465835
Racing Six Days EXC 400	400	2001 - 2003	489944		499703	520919	465835
Champion Edition EXC 450	450	2010 - 2010	489944		499703	520919	465835
EXC 450	450	2006 - 2016	489944		499703	520919	465835
EXC-R 450	450	2008 - 2008	489944		499703	520919	465835
Factory EXC 450	450	2005 - 2005	489944		499703	520919	465835
Factory Racing EXC 450	450	2007 - 2007	489944		499703	520919	465835
Quad SX 450	450	2008 - 2010	489944		499703	520919	465835
Quad XC 450	450	2007 - 2010	489944		499703	520919	465835
Racing EXC 450	450	2003 - 2007	489944		499703	520919	465835
Racing Six Days EXC 450	450	2004 - 2007	489944		499703	520919	465835
Rally Factory Replica 450	450	2011 - 2013	489937		489939	520919	465833
Six Days EXC 450	450	2009 - 2016	489944		499703	520919	465835
Six Days EXC-R 450	450	2008 - 2008	489944		499703	520919	465835
SMR 450	450	2008 - 2014	489937		489939	520919	465833
SX-F 450	450	2016 - 2017	512625				



Modèle	Cylindre	Année	FULBAT		YUASA		
			Préconisation constructeur	Sans entretien acide	Sans entretien gel	Lithium	Réf.
SX-F 450	450	2007 - 2015	489937		489939	520919	465833
SX-F 450	450	2008 - 2010	489944		499703	520919	465835
XC-F 450	450	2008 - 2020	489944		499703	520919	465835
EXC 500	500	2012 - 2016	489944		499703	520919	465835
Six Days EXC 500	500	2012 - 2016	489944		499703	520919	465835
Quad SX 505	505	2009 - 2012	489944		499703	520919	465835
SX-F 505	505	2007 - 2007	489944		499703	520919	465835
XC-F 505	505	2009 - 2009	489944		499703	520919	465835
Racing EXC 520	520	2000 - 2002	489944		499703	520919	465835
Racing Six Days EXC 520	520	2001 - 2002	489944		499703	520919	465835
Desert Racing MXC 525	525	2003 - 2005	489944		499703	520919	465835
Desert Racing XC 525	525	2006 - 2007	489944		499703	520919	465835
Factory EXC 525	525	2005 - 2005	489944		499703	520919	465835
Factory Racing EXC 525	525	2007 - 2007	489944		499703	520919	465835
Quad XC 525	525	2008 - 2012	489944		499703	520919	465835
Racing EXC 525	525	2003 - 2007	489944		499703	520919	465835
Racing Six Days EXC 525	525	2003 - 2007	489944		499703	520919	465835
EXC 530	530	2009 - 2011	489944		499703	520919	465835
EXC-R 530	530	2008 - 2008	489944		499703	520919	465835
Factory Edition EXC 530	530	2011 - 2011	489944		499703	520919	465835
Six Days EXC 530	530	2009 - 2012	489944		499703	520919	465835
Six Days EXC-R 530	530	2008 - 2008	489944		499703	520919	465835
Adventure EGS-E 620	620	1997 - 1997	489940		499706	520922	465836
Competition LC4 620	620	1999 - 1999	489940		499706	520922	465836
Duke 620LC4	620	1994 - 1999	489940		499706	520922	465836
EGS 620	620	1998 - 1999	489940		499706	520922	465836
EGS-E 620	620	1997 - 1997	489940		499706	520922	465836
GS XC 620LC4	620	1994 - 1999	489940		499706	520922	465836
Super Competition LC4 620	620	1998 - 1998	489940		499706	520922	465836
Supermoto LC4 620	620	1999 - 1999	489940		499706	520922	465836
SMC 625	625	2004 - 2006	490331			520922	483849
SXC 625	625	2003 - 2007	490331			520922	483849
Adventure 640	640	2005 - 2007	490331			520922	483849
Adventure LC-4 640	640	2003 - 2006	490331			520922	483849
Adventure-R 640	640	1998 - 2002	489940		499706	520922	465836
Adventure-R 640	640	2004 - 2004	490331			520922	483849
Duke II 640	640	1998 - 2002	489940		499706	520922	465836
Duke II 640	640	2003 - 2007	490331			520922	483849
Enduro LC4 640	640	1998 - 1999	489940		499706	520922	465836
Enduro LC4 640	640	2003 - 2006	490331			520922	483849
Enduro LC4-E 640	640	2000 - 2001	489940		499706	520922	465836
Enduro LC4-E 640	640	2002 - 2002	490331			520922	483849
Six Days LC4 640	640	1999 - 1999	489940		499706	520922	465836
Six Days LC4-E 640	640	2002 - 2002	489940		499706	520922	465836
SMC 640LC4	640	2005 - 2005	490331			520922	483849

MOTEUR

CYCLE

PNEUMATIQUE

ATELIER

ACCESSOIRES

ÉLECTRICITÉ

FILTRATION

FREINAGE

TRANSMISSION

MOTEUR

CYCLE

PNEUMATIQUE

ATELIER

ACCESSOIRES

ÉLECTRICITÉ

FILTRATION

FREINAGE

TRANSMISSION

Modèle	Cylindre	Année	FULBAT		YUASA		Réf.
			Préconisation constructeur	Sans entretien acide	Sans entretien gel	Lithium	
Supermoto LC4 640	640	1999 - 1999	489940		499706	520922	465836
Supermoto LC4 640	640	2003 - 2006	490331			520922	483849
Supermoto LC4-E 640	640	2000 - 2002	489940		499706	520922	465836
Rallye 660	660	2000 - 2000	489944		499703	520919	465835
Rallye 660	660	2001 - 2004	489940		499706	520922	465836
Rallye Factory Replica 660	660	2003 - 2007	490331			520922	483849
Rallye LC4 660	660	1999 - 1999	489944		499703	520919	465835
Duke 690	690	2018 - 2020	517780			520922	510621
Duke 690	690	2008 - 2017	490331			520922	483849
Duke R 690R	690	2010 - 2017	490331			520922	483849
Enduro 690	690	2008 - 2010	490331			520922	483849
Enduro 690R	690	2009 - 2020	490331			520922	483849
Rally Factory Replica 690	690	2007 - 2010	490331			520922	483849
SMC 690	690	2008 - 2011	490331			520922	483849
SMC 690R	690	2012 - 2021	490331			520922	483849
Supermoto 690	690	2007 - 2008	490331			520922	483849
Supermoto Limited Edition 690	690	2009 - 2009	490331			520922	483849
Supermoto R 690R	690	2008 - 2008	490331			520922	483849
Adventure 790	790	2019 - 2022	517780			520922	510621
Adventure R 790	790	2019 - 2020	517780			520922	510621
Adventure R Rally 790	790	2020 - 2020	517780			520922	510621
Duke 790	790	2018 - 2023	517780			520922	510621
Duke L 790	790	2018 - 2020	517780			520922	510621
Adventure 890R	890	2021 - 2023	517780			520922	510621
Adventure L 890R	890	2021 - 2023	517780			520922	510621
Adventure R 890R	890	2021 - 2023	517780			520922	510621
Duke 890GP	890	2023 -	517780			520922	510621
Duke 890R	890	2020 - 2023	517780			520922	510621
Duke Adventure 890R	890	2021 - 2023	517780			520922	510621
Duke L 890R	890	2021 - 2023	517780			520922	510621
Adventure 950	950	2002 - 2005	490556			520922	490512
Adventure S 950	950	2003 - 2006	490556			520922	490512
Super Enduro 950R	950	2006 - 2008	490556			520922	490512
Supermoto 950	950	2005 - 2008	490556			520922	490512
Supermoto 950R	950	2007 - 2008	490556			520922	490512
Adventure 990	990	2006 - 2012	490556			520922	490512
Adventure Dakar Edition 990	990	2011 - 2011	490556			520922	490512
Adventure Limited Edition 990	990	2010 - 2010	490556			520922	490512
Adventure R 990R	990	2009 - 2012	490556			520922	490512
Adventure S 990S	990	2006 - 2008	490556			520922	490512
Super Duke 990	990	2005 - 2012	490556			520922	490512
Super Duke R 990R	990	2007 - 2013	490556			520922	490512
Supermoto R SM 990R	990	2008 - 2013	490556			520922	490512
Supermoto SM 990	990	2008 - 2010	490556			520922	490512



Modèle	Cylindre	Année	FULBAT		YUASA		
			Préconisation constructeur	Sans entretien acide	Sans entretien gel	Lithium	Réf.
Supermoto T SM 990T	990	2009 - 2013	490556			520922	490512
Adventure 1050	1050	2015 - 2016	490556			520922	490512
Adventure 1090	1090	2017 - 2018	490556			520922	490512
Adventure 1090R	1090	2017 - 2020	490556			520922	490512
Adventure 1090S	1090	2019 - 2020	490556			520922	490512
Adventure L 1090L	1090	2017 - 2020	490556			520922	490512
Adventure 1190	1190	2013 - 2016	490556			520922	490512
Adventure R 1190R	1190	2013 - 2016	490556			520922	490512
RC 8	1190	2008 - 2011	490556			520922	490512
RC 8R	1190	2009 - 2015	490556			520922	490512
Super Adventure 1290	1290	2015 - 2021	490556			520922	490512
Super Adventure 1290R	1290	2017 - 2021	490556			520922	490512
Super Adventure 1290S	1290	2017 - 2023	490556			520922	490512
Super Adventure 1290T	1290	2017 - 2021	490556			520922	490512
Super Duke 1290 R Evo	1290	2022 - 2023	490556			520922	490512
Super Duke GT 1290	1290	2016 - 2023	490556			520922	490512
Super Duke R 1290R	1290	2014 - 2020	489946		499708	520922	465838
Super Duke R 1290R	1290	2018 - 2023	490556			520922	490512
Super Duke R 1290R	1290	2020 - 2023	490556			520922	490512
Super Duke R SE 1290R	1290	2016 - 2017	489946		499708	520922	465838
KYMCO							
Agility 125	125	2006 - 2021	489941		499704	520922	465834
Agility 16+ 125	125	2020 - 2022	489940		499706	520922	465836
Agility Carry 125 (4T)	125	2011 - 2022	489941		499704	520922	465834
Agility City + 125	125	2014 - 2022	489941		499704	520922	465834
Agility One 125	125	2009 - 2009	489941		499704	520922	465834
Agility RS 125	125	2010 - 2015	489941		499704	520922	465834
Bet and Win	125	2000 - 2006	489940		499706	520922	465836
Calypso 125	125	1999 - 1999	489944		499703	520919	465835
CK1 125	125	2014 - 2016	493812				462571
Cruiser 125	125	1999 - 1999	489941		499704	520922	465834
Dink 125i	125	2006 - 2021	489940		499706	520922	465836
Dink Classic 125	125	2002 - 2002	489940		499706	520922	465836
Dink LX 125	125	1998 - 2000	489940		499706	520922	465836
Dink - Spacer 125	125	1997 - 2004	489940		499706	520922	465836
DJ 125S	125	2012 - 2016	489941		499704	520922	465834
Downtown 125i	125	2009 - 2021	489940		499706	520922	465836
DTX360 125	125	2021 - 2022	489940		499706	520922	465836
Grand Dink 125	125	2008 - 2008	489940		499706	520922	465836
Grand Dink 125i	125	2012 - 2016	489940		499706	520922	465836
Grand Dink 125S	125	2009 - 2015	489940		499706	520922	465836
Grand Dink Miller 125	125	2001 - 2007	489940		499706	520922	465836
Heroism 125	125	1995 - 1996	489940		499706	520922	465836
Hipster 125	125	1999 - 2007	489941		499704	520922	465834

MOTEUR

CYCLE

PNEUMATIQUE

ATELIER

ACCESSOIRES

ÉLECTRICITÉ

FILTRATION

FREINAGE

TRANSMISSION

Modèle	Cylindre	Année	FULBAT		FULBAT		YUASA
			Préconisation constructeur	Sans entretien acide	Sans entretien gel	Lithium	Réf.
K-Pipe K 125	125	2012 - 2015	489941		499704	520922	465834
K-XCT K 125i	125	2012 - 2015	489940		499706	520922	465836
Like 125	125	2009 - 2021	489941		499704	520922	465834
Like ie ABS Noodoe E5 125	125	2020 - 2022	489940		499706	520922	465836
Like ie CBS E5 125	125	2020 - 2022	489940		499706	520922	465836
Like ie Sport 125	125	2019 - 2022	489940		499706	520922	465836
Like Xperience 125	125	2019 - 2021	489941		499704	520922	465834
Movie 125	125	1999 - 2000	489940		499706	520922	465836
Movie 125i	125	2012 - 2013	489940		499706	520922	465836
Movie XL 125	125	2001 - 2009	489940		499706	520922	465836
People 125	125	1999 - 2014	489941		499704	520922	465834
People GT 125i	125	2010 - 2014	490561		517780	520922	472408 481623
People One 125i	125	2013 - 2020	489941		499704	520922	465834
People S 125	125	2005 - 2015	489941		499704	520922	465834
People S S 125i	125	2018 - 2022			490564	520921	
Pulsar 125	125	2000 - 2008	493812		513057		462571
Pulsar CK 125	125	2004 - 2005	489941		499704	520922	465834
Pulsar II 125	125	2008 - 2013	493812		513057		462571
Pulsar Luxe 125	125	1999 - 2007	493812		513057		462571
Pulsar S 125	125	2011 - 2015	493812		513057		462571
Quad MXer 125	125	2002 - 2007	489940		499706	520922	465836
Quannon Naked KR 125	125	2010 - 2015			491434	520921	
Quannon Sport KR 125	125	2007 - 2013			491434	520921	
Stryker 125	125	2001 - 2006	489941		499704	520922	465834
Super 8 125	125	2008 - 2016	489941		499704	520922	465834
Super Dink 125i	125	2009 - 2014	489940		499706	520922	465836
Visar 125	125	2011 - 2015	489938	526367	499700		462573
Vivio 125	125	2000 - 2003	489940		499706	520922	465836
X Town 125i	125	2016 - 2021	489943		499707	520922	465837
X Town City 125i	125	2021 - 2022	489943		499707	520922	465837
Yager GT 125	125	2007 - 2013	489940		499706	520922	465836
Zing Custom Style 125	125	1997 - 2006	489941		499704	520922	465834
Zing II Custom Style 125	125	2007 - 2016	489941		499704	520922	465834
Zing II Dark side 125	125	2016 - 2017	489941		499704	520922	465834
Agility 150	150	2008 - 2012	489941		499704	520922	465834
Bet and Win	150	2001 - 2006	489940		499706	520922	465836
Dink Classic 150	150	2002 - 2002	489940		499706	520922	465836
Dink LX 150	150	1998 - 2000	489940		499706	520922	465836
Dink Spacer 150	150	1997 - 2004	489940		499706	520922	465836
Grand Dink 150	150	2008 - 2011	489940		499706	520922	465836
Grand Dink Miler 150	150	2001 - 2007	489940		499706	520922	465836
Heroism 150	150	1995 - 1997	489940		499706	520922	465836
Movie XL 150	150	2001 - 2009	489940		499706	520922	465836



Modèle	Cylindre	Année	FULBAT	FULBAT	YUASA		
			Préconisation constructeur	Sans entretien acide	Sans entretien gel	Lithium	Réf.
People 150	150	1999 - 2004	489941		499704	520922	465834
Quad MXer 150	150	2002 - 2007	489940		499706	520922	465836
Quad MXU 150	150	2005 - 2016	489940		499706	520922	465836
Stryker 150	150	2000 - 2006	489941		499704	520922	465834
Vivio 150	150	2000 - 2003	489940		499706	520922	465836
Zing Custom Style 150	150	1997 - 2013	489941		499704	520922	465834
Agility 200i	200	2010 - 2015	489940		499706	520922	465836
Dink 200i	200	2006 - 2015	490561		517780	520922	472408 481623
Downtown 200i	200	2010 - 2015	490561		517780	520922	472408 481623
Like 200i	200	2009 - 2015	489940		499706	520922	465836
People S 200	200	2005 - 2006	489941		499704	520922	465834
People S 200i DD	200	2007 - 2014	490331			520922	483849
Yager 200i	200	2007 - 2013	490561		517780	520922	472408 481623
Bet and Win	250	2000 - 2006	489943		499707	520922	465837
Grand Dink 250	250	2001 - 2006	489943		499707	520922	465837
Maxxer 250	250	2007 - 2016	489943		499707	520922	465837
Mongoose KXR 250	250	2004 - 2007	489943		499707	520922	465837
MXU 250	250	2004 - 2013	489943		499707	520922	465837
MXU 250R	250	2012 - 2013	524569	512638	511540		
People 250	250	2003 - 2006	489943		499707	520922	465837
People 250Si DD	250	2007 - 2008	489943		499707	520922	465837
People Gti 250	250	2010 - 2011	489943		499707	520922	465837
Urban Quad 250	250	2006 - 2006	489943		499707	520922	465837
Venox 250	250	2000 - 2006	489940		499706	520922	465836
Xciting 250	250	2005 - 2005	489943		499707	520922	465837
Xciting 250i	250	2006 - 2008	489943		499707	520922	465837
Yup 250	250	2003 - 2006	489943		499707	520922	465837
Downtown 300i	300	2009 - 2016	490561		517780	520922	472408 481623
Grand Dink 300i	300	2012 - 2021	490561		517780	520922	472408 481623
K-XCT 300i	300	2012 - 2016	490561		517780	520922	472408 481623
Maxxer 300	300	2005 - 2016	489943		499707	520922	465837
MXU 300	300	2006 - 2011	489943		499707	520922	465837
MXU 300R	300	2010 - 2014	524569	512638	511540		
People GT 300i	300	2010 - 2016	490561		517780	520922	472408 481623
People S 300i	300	2008 - 2010	490561		517780	520922	472408 481623
X Town 300i	300	2016 - 2021	489943		499707	520922	465837
Xciting 300i	300	2008 - 2008	489943		499707	520922	465837
Xciting R 300i	300	2009 - 2016	489943		499707	520922	465837

Modèle	Cylindre	Année	FULBAT	FULBAT	YUASA		Réf.
			Préconisation constructeur	Sans entretien acide	Sans entretien gel	Lithium	
Downtown 350i	350	2015 - 2020	490561		517780	520922	472408 481623
Downtown TCS e5 350i	350	2021 - 2022	490556			520922	490512
DTX 360i	350	2021 - 2022	499706			520922	510617
Maxxer 400	400	2009 - 2010	489946		499708	520922	465838
MXU 400	400	2008 - 2011	524569	512638	511540		
Xciting 400i	400	2012 - 2016	489946		499708	520922	465838
Xciting S 400i	400	2019 - 2022	489946		499708	520922	465838
Maxxer 450	450	2010 - 2015	489948		499709	520924	
MXU 450i	450	2011 - 2015	489948		499709	520924	
UXV 450i	450	2015 - 2015	489948		499709	520924	
MXU 500	500	2005 - 2013	489948		499709	520924	
MXU 500i DX	500	2012 - 2013	489948		499709	520924	
MXU 500i IRS	500	2009 - 2014	489948		499709	520924	
UXV 500	500	2008 - 2009	489948		499709	520924	
UXV 500i	500	2010 - 2015	489948		499709	520924	
Xciting 500	500	2005 - 2005	489946		499708	520922	465838
Xciting 500i	500	2006 - 2008	489946		499708	520922	465838
Xciting Evo 500i	500	2013 - 2013	489946		499708	520922	465838
Xciting R 500i	500	2007 - 2016	489946		499708	520922	465838
AK 550	550	2017 - 2018	490330			520922	490511
AK 550	550	2019 - 2022	490556			520922	490512
CV3 550	550	2022 - 2023	490556			520922	490512
MXU 550i	550	2012 - 2015	489948		499709	520924	
MXU 700i	700	2013 - 2015	489948		499709	520924	
My Road 700i	700	2011 - 2016	489946		499708	520922	465838
LAVERDA							
Custom Sabbia LB 125	125	1985 - 1987	493810		513055		
Lesmo GS 125	125	1986 - 1989	493810		513055		
Sport LZ 125	125	1980 - 1982	500960				
Phoenix 150	150	2001 - 2004	489940		499706	520922	465836
Phoenix 200	200	2001 - 2004	489940		499706	520922	465836
Formula 650	650	1994 - 1995	490558	512637	499702		465842
Ghost 650	650	1996 - 1997	490558	512637	499702		465842
Legend 650	650	1997 - 1997	490558	512637	499702		465842
Sport 650	650	1995 - 1996	490558	512637	499702		465842
Strike 650	650	1997 - 1997	490558	512637	499702		465842
668	668	1996 - 1997	490558	512637	499702		465842
Ghost 668	668	1998 - 1999	490558	512637	499702		465842
Ghost Strike 668	668	1998 - 1999	490558	512637	499702		465842
750S	750	1998 - 1999	489949 489936		499699	520919	462567 483973 510611 512772



Modèle	Cylindre	Année	FULBAT		FULBAT		YUASA
			Préconisation constructeur	Sans entretien acide	Sans entretien gel	Lithium	Réf.
Formula 750	750	1998 - 1999	489949 489936		499699	520919	462567 483973 510611 512772
Formula 750S	750	2000 - 2001	489949 489936		499699	520919	462567 483973 510611 512772
1000RGA - RGS	1000	1983 - 1983	493814		511544	520926	
1000RGS	1000	1982 - 1982	493814		511544	520926	
Corsa 1000RGS	1000	1984 - 1984	493814		511544	520926	
1200	1200	1978 - 1979	493814		511544	520926	
Mirage 1200TS	1200	1981 - 1981	493814		511544	520926	
MALAGUTI							
Ciak 125	125	2001 - 2008	489938	526367	499700		462573
Madison 1253	125	2006 - 2009	489938	526367	499700		462573
Madison R 125	125	2003 - 2007	489938	526367	499700		462573
Madison T 125	125	1999 - 2003	489938	526367	499700		462573
Warrior F18 125	125	2000 - 2003	489938	526367	499700		462573
Ciak 150	150	2001 - 2008	489938	526367	499700		462573
Madison T 150	150	1999 - 2003	489938	526367	499700		462573
Warrior F18 150	150	2000 - 2003	489938	526367	499700		462573
Madison T 180	180	1999 - 2003	489938	526367	499700		462573
Madison 250ie 3	250	2006 - 2010	489938	526367	499700		462573
Madison RS 250	250	2004 - 2007	489938	526367	499700		462573
Madison S 250	250	1999 - 2003	489938	526367	499700		462573
Password 250	250	2005 - 2011	489943		499707	520922	465837
Phantom Max 250	250	2004 - 2008	489943		499707	520922	465837
Madison K 400	400	2002 - 2006	491025		499701		462574
Spider Max GT 500	500	2004 - 2010	490558	512637	499702		465842
Spider Max RS 500	500	2004 - 2011	490558	512637	499702		465842
MASH							
Black Seven 125	125	2017 - 2020	526367		499700		
Café Racer 125	125	2014 - 2022	526367		499700		
Dirt track 125	125	2020 - 2023	526367		499700		
Scrambler 125	125	2014 - 2023	526367		499700		
Seventy 125	125	2013 - 2023	526367		499700		
Seventy Five 125	125	2014 - 2020	526367		499700		
Sixty Five 125	125	2013 - 2023	526367		499700		
Two Fifty 250	250	2017 - 2020	526367		499700		
Five Hundred Roadstar 400	400	2013 - 2016	526367		499700		
Scrambler 400	400	2017 - 2020	526367		499700		
Side Force 440	440	2020 - 2023	490556			520922	490512
Dirt track 650	650	2020 - 2023	490556			520922	490512
Six Hundred 650	650	2020 - 2023	490556			520922	490512
X-Ride 650	650	2020 - 2023	490556			520922	490512

Modèle	Cylindre	Année	FULBAT		FULBAT		YUASA
			Préconisation constructeur	Sans entretien acide	Sans entretien gel	Lithium	Réf.
MOTO GUZZI							
Florida V 35	350	1986 - 1990		489948	499709	520924	
Nevada 350	350	1992 - 1993		504082	511545	520924	
Nevada 350	350	1994 - 1997		489948	499709	520924	
Nevada Club 350	350	1998 - 1999	493814		511544	520926	
NTX 350	350	1987 - 1990		489948	499709	520924	
V 35	350	1977 - 1979	493814		511544	520926	
V 35C	350	1982 - 1986		489948	499709	520924	
V 35II	350	1980 - 1985	493814		511544	520926	
V 35III	350	1985 - 1987	493814		511544	520926	
V 50	500	1977 - 1979	493814		511544	520926	
V 50C	500	1982 - 1986		489948	499709	520924	
V 50III	500	1980 - 1984	493814		511544	520926	
V 50PA	500	1992 - 2001	493814		511544	520926	
Custom V 65	650	1982 - 1985	493814		511544	520926	
Florida V 65	650	1986 - 1992	493814		511544	520926	
NTX 650	650	1987 - 1990		489948	499709	520924	
Anniversary V 7III	750	2017 - 2017	489946		499708	520922	465838
Breva 750ie	750	2003 - 2013	512637		499702		
Cafe Classic V 7	750	2009 - 2009	512637		499702		
Cafe Classic V 7	750	2010 - 2012	489946		499708	520922	465838
Carbon V 7III	750	2018 - 2020	489946		499708	520922	465838
Classic V 7	750	2008 - 2009	512637		499702		
Classic V 7	750	2010 - 2012	489946		499708	520922	465838
Limited V 7III	750	2018 - 2019	489946		499708	520922	465838
Milano V 7III	750	2018 - 2020	489946		499708	520922	465838
Nevada 750	750	1993 - 2003	493814		511544	520926	
Nevada 750	750	1991 - 1992		489948	499709	520924	
Nevada 750	750	2004 - 2011	512637		499702		
Nevada Classic 750ie	750	2005 - 2015	512637		499702		
Nevada Club 750	750	1998 - 2004	493814		511544	520926	
Nevada Touring 750	750	2007 - 2007	512637		499702		
Racer 10th Anniversary V 7III	750	2020 - 2020	489946		499708	520922	465838
Racer V 7	750	2010 - 2014	489946		499708	520922	465838
Racer V 7II	750	2015 - 2016	489946		499708	520922	465838
Racer V 7III	750	2017 - 2017	489946		499708	520922	465838
Rough V 7III	750	2018 - 2020	489946		499708	520922	465838
Special V 7	750	2012 - 2014	489946		499708	520922	465838
Special V 7II	750	2015 - 2016	489946		499708	520922	465838
Special V 7III	750	2017 - 2021	489946		499708	520922	465838
Stone V 7	750	2012 - 2014	489946		499708	520922	465838
Stone V 7II	750	2015 - 2016	489946		499708	520922	465838
Stone V 7III	750	2017 - 2020	489946		499708	520922	465838
Stornello V 7II	750	2016 - 2017	489946		499708	520922	465838
V 75	750	1992 - 1996	493814		511544	520926	



Modèle	Cylindre	Année	FULBAT		YUASA		Réf.
			Préconisation constructeur	Sans entretien acide	Sans entretien gel	Lithium	
850T5	850	1995 - 2001	493814		511544	520926	
Bobber V 9	850	2016 - 2023	489946		499708	520922	465838
Breva 850	850	2006 - 2007	500868		513064		
California 850T3	850	1979 - 1979	493814		511544	520926	
California 850T4	850	1980 - 1982	493814		511544	520926	
California 850T5	850	1983 - 1988	493814		511544	520926	
Griso 850	850	2006 - 2007	500868		513064		
Le Mans 850	850	1978 - 1978	493814		511544	520926	
Le Mans 850II	850	1979 - 1980	493814		511544	520926	
Le Mans 850III	850	1981 - 1984	493814		511544	520926	
Norge 850	850	2007 - 2007	500868		513064		
Roamer V 9	850	2016 - 2023	489946		499708	520922	465838
Special V 7	850	2021 - 2023	489946		499708	520922	465838
Stone V 7	850	2021 - 2023	489946		499708	520922	465838
V 85 TT 850	850	2019 - 2023	489946		499708	520922	465838
Bellagio 940	940	2007 - 2010	500868		513064		
Bellagio Apuila Nera 940	940	2010 - 2013	500868		513064		
Bellagio Deluxe 940	940	2009 - 2013	500868		513064		
1000GT	1000	1987 - 1991	493814		511544	520926	
1000S	1000	1989 - 1994	493814		511544	520926	
1000SP	1000	1979 - 1983	493814		511544	520926	
1000SP II	1000	1988 - 1988	493814		511544	520926	
1000SP III	1000	1989 - 1994	493814		511544	520926	
California II 1000	1000	1983 - 1986	493814		511544	520926	
California III 1000	1000	1987 - 1993	493814		511544	520926	
California III Iniezione 1000	1000	1990 - 1993	493814		511544	520926	
Centaur V 10	1000	1997 - 1999	489948		499709	520924	
Daytona 1000RS	1000	1997 - 1998	489948		499709	520924	
Le Mans 1000	1000	1983 - 1994	493814		511544	520926	
Quota 1000	1000	1992 - 1997		504082	511545	520924	
Strada 1000	1000	1993 - 1994	493814		511544	520926	
V100 Mandello	1043	2021 - 2023	489946		499708	520922	465838
Breva 1100	1100	2004 - 2009	500868		513064		
Cafe Bellabio V 11	1100	2003 - 2005	489948		499709	520924	
California 1100	1100	1994 - 1997	493814		511544	520926	
California 1100EV	1100	1997 - 2001	493814		511544	520926	
California 90 Anniversario 1100	1100	2011 - 2013	489948		499709	520924	
California Aluminium 1100	1100	2003 - 2005	493814		511544	520926	
California Aquila Nera 1100	1100	2010 - 2011	489948		499709	520924	
California Classic 1100	1100	2006 - 2012	489948		499709	520924	
California Jackal 1100	1100	1999 - 2001	493814		511544	520926	
California Metal 1100	1100	2002 - 2003	493814		511544	520926	
California Special 1100	1100	1999 - 2000	493814		511544	520926	
California Special Sport 1100	1100	2001 - 2002	493814		511544	520926	
California Stone 1100	1100	2001 - 2005	493814		511544	520926	

MOTEUR

CYCLE

PNEUMATIQUE

ATELIER

ACCESSOIRES

ÉLECTRICITÉ

FILTRATION

FREINAGE

TRANSMISSION

Modèle	Cylindre	Année	FULBAT	FULBAT	YUASA		Réf.
			Préconisation constructeur	Sans entretien acide	Sans entretien gel	Lithium	
California Titanium 1100	1100	2003 - 2005	493814		511544	520926	
California Touring 1100	1100	2006 - 2012	489948		499709	520924	
California Vintage 1100	1100	2006 - 2013	489948		499709	520924	
Griso 1100	1100	2005 - 2008	500868		513064		
Griso 11004V	1100	2005 - 2008	500868		513064		
Le Mans 1100	1100	2003 - 2004	493814		511544	520926	
Le Mans 1100	1100	2001 - 2002	489948		499709	520924	
Le Mans Sport Naked V 11	1100	2001 - 2002	489948		499709	520924	
Quota 1100ES	1100	1998 - 2002	489948		499709	520924	
Sport 1100	1100	1994 - 1995	493814		511544	520926	
Sport 1100	1100	1996 - 1999	489948		499709	520924	
Sport Corsa 1100	1100	1998 - 1999	489948		499709	520924	
Sport Mandello V 11	1100	1999 - 2001	489948		499709	520924	
Sport V 11	1100	1999 - 2004	489948		499709	520924	
Breva 1200	1200	2007 - 2011	500868		513064		
Corsa MGS 1	1200	2007 - 2011	489948		499709	520924	
Griso 12008V	1200	2007 - 2015	500868		513064		
Griso Special Edition 12008V	1200	2009 - 2015	500868		513064		
Norge 1200	1200	2006 - 2012	500868		513064		
Norge GT 12008V	1200	2008 - 2015	500867		513063		
Sport 1200	1200	2006 - 2007	500868		513064		
Sport 12004V	1200	2006 - 2013	500868		513064		
Sport 12008V	1200	2008 - 2013	500868		513064		
Stelvio 1200	1200	2008 - 2011	500868		513064		
Stelvio 12008V	1200	2011 - 2015	500868		513064		
Stelvio NTX 1200	1200	2009 - 2010	500868		513064		
Stelvio NTX 12008V	1200	2011 - 2015	500868		513064		
Flying Fortress MGX 211380	1380	2016 - 2019	500868		513064		
Audace 1400	1400	2015 - 2016	500868		513064		
Audace Carbon 1400	1400	2017 - 2017	500868		513064		
California Custom 1400	1400	2013 - 2015	500867		513063		
California Touring 1400	1400	2013 - 2016	500868		513064		
California Touring SE 1400	1400	2015 - 2017	500868		513064		
Eldorado 1400	1400	2015 - 2017	500868		513064		
MOTO MORINI							
X-Cape 650	650	2021 - 2023	499707			520922	510619
MV AGUSTA							
Brutale 675	675	2012 - 2017	490331			520922	483849
F3 675	675	2011 - 2018	490331			520922	483849
RC F3 675	675	2015 - 2018	490331			520922	483849
Serie Oro F3 675	675	2012 - 2015	490331			520922	483849
Brutale 750	750	2001 - 2002	490331			520922	483849
Brutale 750S	750	2003 - 2005	490331			520922	483849
Brutale Oro 750	750	2003 - 2005	490331			520922	483849



Modèle	Cylindre	Année	FULBAT	FULBAT	YUASA		
			Préconisation constructeur	Sans entretien acide	Sans entretien gel	Lithium	Réf.
F4 750S	750	1999 - 2005	490331			520922	483849
F4 750SPR	750	2003 - 2004	490331			520922	483849
Oro F4 750	750	1999 - 1999	490331			520922	483849
Senna F4 750	750	2002 - 2003	490331			520922	483849
Brutale 800	800	2012 - 2018	490331			520922	483849
Brutale Rosso 800	800	2020 - 2023	490331			520922	483849
Brutale RR 800RR	800	2015 - 2023	490331			520922	483849
Dragster RC 800RC	800	2017 - 2018	490331			520922	483849
Dragster RC SCS 800	800	2022 - 2023	490331			520922	483849
Dragster Rosso 800	800	2020 - 2023	490331			520922	483849
Dragster RR 800RR	800	2015 - 2023	490331			520922	483849
F3 800	800	2012 - 2021	490331			520922	483849
F3 800 Ago	800	2014 - 2015	490331			520922	483849
F3 800 RC	800	2015 - 2023	490331			520922	483849
F3 800 Rosso	800	2021 - 2023	490331			520922	483849
F3 800 RR	800	2015 - 2023	490331			520922	483849
Rivale 800	800	2013 - 2018	490331			520922	483849
Stradale 800	800	2015 - 2015	490331			520922	483849
Superveloce 800 (ALPINE, S, 75th Anniversary) 800	800	2019 - 2023	490330			520922	490511
Turismo Veloce 800	800	2016 - 2023	490330			520922	490511
Turismo Veloce 800 Lusso	800	2022 - 2023	490330			520922	490511
Turismo Veloce 800 Lusso SCS	800	2022 - 2023	490330			520922	490511
Turismo Veloce 800 RC SCS	800	2022 - 2023	490330			520922	490511
Turismo Veloce 800 Rosso	800	2022 - 2023	490330			520922	490511
Brutale 910R	910	2005 - 2008	490331			520922	483849
Brutale 910S	910	2005 - 2008	490331			520922	483849
Brutale 920	920	2010 - 2012	490331			520922	483849
Lucky Explorer	930	2023 -	517781				
Brutale 989R	989	2008 - 2009	490331			520922	483849
Brutale 990R	990	2010 - 2011	490331			520922	483849
Brutale 1000 Nurburring	1000	2022 - 2023	490331			520922	483849
Brutale 1000RR	1000	2022 - 2023	490331			520922	483849
Brutale 1000RS	1000	2022 - 2023	490331			520922	483849
Corsa Corta F4RR 998	1000	2012 - 2012	490331			520922	483849
F4 1000	1000	2004 - 2006	490331			520922	483849
F4 998	1000	2010 - 2016	490331			520922	483849
F4R 1000	1000	2006 - 2007	490331			520922	483849
F4R 998	1000	2012 - 2016	490331			520922	483849
F4RR 1000312R	1000	2007 - 2007	490331			520922	483849
F4RR 998	1000	2010 - 2016	490331			520922	483849
Brutale 1078RR	1078	2008 - 2009	490331			520922	483849
Claudio Castiglioni F4 1078	1078	2007 - 2007	490331			520922	483849
F4RR 1078312	1078	2008 - 2009	490331			520922	483849
Brutale 1090	1090	2013 - 2015	490331			520922	483849

MOTEUR

CYCLE

PNEUMATIQUE

ATELIER

ACCESSOIRES

ÉLECTRICITÉ

FILTRATION

FREINAGE

TRANSMISSION

Modèle	Cylindre	Année	FULBAT	FULBAT	YUASA		Réf.
			Préconisation constructeur	Sans entretien acide	Sans entretien gel	Lithium	
Brutale 1090R	1090	2012 - 2015	490331			520922	483849
Brutale 1090RR	1090	2010 - 2016	490331			520922	483849
Brutale Corsa 1090	1090	2013 - 2013	490331			520922	483849
MZ (MUZ)							
Saxon 125	125	1993 - 1997	489935		511534	520919	462568
Baghira - Black Panther 660	660	1996 - 2003	500869				
Baghira - Forest Forest HR 660	660	1996 - 2005	500869				
Baghira - Street Moto 660	660	1996 - 2005	500869				
Baghira 660	660	1997 - 2005	500869				
Fun bike 660	660	1997 - 1998	500869				
Mastiff 660	660	1996 - 2005	500869				
Skorpion Cup 660	660	1995 - 2001	500869				
Skorpion Replica 660	660	1995 - 2001	500869				
Skorpion Sport 660	660	1995 - 2001	500869				
Skorpion Tour 660	660	1995 - 2002	500869				
Skorpion Traveller 660	660	1998 - 2002	500869				
Trouper 660	660	1997 - 1998	500869				
NORTON							
Commando 961SE	961	2010 - 2011	490556			520922	490512
Commando 961SF	961	2013 - 2015	490556			520922	490512
Commando Cafe Racer 961	961	2010 - 2015	490556			520922	490512
Commando Dominator SS 961	961	2015 - 2015	490556			520922	490512
Commando Sport 961	961	2010 - 2015	490556			520922	490512
PEUGEOT							
City Star 125	125	2011 - 2015	489940		499706	520922	465836
City Star 125i	125	2013 - 2013	491025		499701		462574
City Star 125i	125	2014 - 2021	491025		499701		462574
City Star Active 125i	125	2013 - 2013	491025		499701		462574
City Star Blue Line 125	125	2015 - 2015	489940		499706	520922	465836
Django Allure 125	125	2014 - 2021	489941		499704	520922	465834
Django Allure SBC 125	125	2014 - 2021	489941		499704	520922	465834
Django Dark ABS 125	125	2022 - 2023	489941		499704	520922	465834
Django Evasion 125	125	2014 - 2021	489941		499704	520922	465834
Django Evasion SBC 125	125	2014 - 2021	489941		499704	520922	465834
Django Heritage 125	125	2014 - 2021	489941		499704	520922	465834
Django Heritage SBC 125	125	2014 - 2021	489941		499704	520922	465834
Django S 125S	125	2014 - 2021	489941		499704	520922	465834
Django Shadow ABS 125	125	2022 - 2023	489941		499704	520922	465834
Django Sport 125	125	2014 - 2023	489941		499704	520922	465834
Django Sport SBC 125	125	2014 - 2021	489941		499704	520922	465834
Elyseo 125	125	1998 - 2003	493812		513057		462571
Elystar 125	125	2002 - 2010	493812		513057		462571
Geo RS 125	125	2007 - 2012	491025		499701		462574
Geo SV 125	125	1991 - 1993	489935		511534	520919	462568



Modèle	Cylindre	Année	FULBAT	FULBAT	YUASA		
			Préconisation constructeur	Sans entretien acide	Sans entretien gel	Lithium	Réf.
Geopolis 125	125	2007 - 2013	491025		499701		462574
Geopolis Executive 125	125	2007 - 2013	491025		499701		462574
Geopolis Premium 125	125	2007 - 2012	491025		499701		462574
Geopolis Urban 125	125	2007 - 2012	491025		499701		462574
Jet Force 125	125	2003 - 2011	491025		499701		462574
LooXoR 125	125	2003 - 2006	491025		499701		462574
Ludix Ambition 125	125	2004 - 2004	491025		499701		462574
LXR 125	125	2010 - 2013	489940		499706	520922	465836
New Tweet Evo 125	125	2014 - 2021	489941		499704	520922	465834
New Tweet Evo RS 125	125	2014 - 2021	489941		499704	520922	465834
Pulsion Active 125	125	2019 - 2023	491025		499701		462574
Pulsion Allure 125	125	2019 - 2023	491025		499701		462574
Pulsion GT 125	125	2022 - 2023	491025		499701		462574
Pulsion RS 125	125	2019 - 2021	491025		499701		462574
Satelis 125	125	2013 - 2013	491025		499701		462574
Satelis Avenue 125	125	2008 - 2009	491025		499701		462574
Satelis Blacksat 125	125	2010 - 2012	491025		499701		462574
Satelis Compressor 125	125	2006 - 2012	491025		499701		462574
Satelis Executive - Premium - City 1254V	125	2006 - 2009	491025		499701		462574
Satelis RS 125	125	2007 - 2012	491025		499701		462574
Satelis RS 125 (4T)	125	2013 - 2013	491025		499701		462574
Satelis Urban 125	125	2007 - 2012	491025		499701		462574
Satelis Whitesat 125	125	2010 - 2012	491025		499701		462574
Speedfight 125	125	2014 - 2015	489941		499704	520922	465834
Speedfight Darkside 125	125	2014 - 2015	489941		499704	520922	465834
Speedfight Iceblade 125	125	2014 - 2015	489941		499704	520922	465834
Speedfight Team 125	125	2014 - 2015	489941		499704	520922	465834
Sum-Up 125	125	2008 - 2011	489941		499704	520922	465834
Tweet 125	125	2010 - 2023	489941		499704	520922	465834
Tweet 125 GT	125	2022 - 2023	489941		499704	520922	465834
Tweet RS 125	125	2011 - 2013	489941		499704	520922	465834
Vivacity 125	125	2010 - 2015	489941		499704	520922	465834
Vivacity Sixties 125	125	2011 - 2012	489941		499704	520922	465834
Django Allure 150	150	2014 - 2017	489941		499704	520922	465834
Django Evasion 150	150	2014 - 2021	489941		499704	520922	465834
Django Heritage 150	150	2014 - 2021	489941		499704	520922	465834
Django S 150S	150	2014 - 2021	489941		499704	520922	465834
Django Sport 150	150	2014 - 2021	489941		499704	520922	465834
Elyseo 150	150	1998 - 2003	493812		513057		462571
Elystar 150	150	2002 - 2010	493812		513057		462571
New Tweet Evo RS 150	150	2014 - 2021	489941		499704	520922	465834
Tweet 150	150	2010 - 2012	489941		499704	520922	465834
Tweet RS 150	150	2010 - 2012	489941		499704	520922	465834
City Star 200i	200	2012 - 2015	489940		499706	520922	465836
LXR 200i	200	2010 - 2011	489940		499706	520922	465836

MOTEUR

CYCLE

PNEUMATIQUE

ATELIER

ACCESSOIRES

ÉLECTRICITÉ

FILTRATION

FREINAGE

TRANSMISSION

Modèle	Cylindre	Année	FULBAT	FULBAT	YUASA		Réf.
			Préconisation constructeur	Sans entretien acide	Sans entretien gel	Lithium	
Geo 250	250	2007 - 2011	491025		499701		462574
Geopolis Executive 250	250	2007 - 2012	491025		499701		462574
Geopolis Premium 250	250	2007 - 2011	491025		499701		462574
Geopolis Urban 250	250	2007 - 2011	491025		499701		462574
Satelis Premium 250	250	2007 - 2012	491025		499701		462574
Satelis RS 250	250	2007 - 2012	491025		499701		462574
Satelis Urban 250	250	2007 - 2012	491025		499701		462574
SV 250	250	2001 - 2002	489943		499707	520922	465837
Geo RS 300	300	2010 - 2012	491025		499701		462574
Geopolis 300	300	2010 - 2013	491025		499701		462574
Geostyle 300	300	2010 - 2012	491025		499701		462574
Satelis 2 300 (4T)	300	2014 - 2015	489943		499707	520922	465837
Satelis 300 (4T)	300	2013 - 2013	489943		499707	520922	465837
Geo RS 400	400	2008 - 2012	490558	512637	499702		465842
Geopolis Premium 400	400	2007 - 2012	490558	512637	499702		465842
Geopolis Urban 400	400	2007 - 2012	490558	512637	499702		465842
Metropolis 400T	400	2013 - 2014	489946		499708	520922	465838
Metropolis 400T	400	2015 - 2016	500868		513064		
Metropolis Access 400T	400	2019 - 2021	500868		513064		
Metropolis Active 400T	400	2022 - 2023	500868		513064		
Metropolis Allure 400T	400	2019 - 2023	500868		513064		
Metropolis Black Edition 400T	400	2019 - 2021	500868		513064		
Metropolis Blue Line 400T	400	2015 - 2016	500868		513064		
Metropolis RS 400T	400	2014 - 2014	489946		499708	520922	465838
Metropolis RS 400T	400	2014 - 2014	489946		499708	520922	465838
Metropolis RS 400T	400	2015 - 2016	500868		513064		
Metropolis Ultimate Business 400T	400	2019 - 2021	500868		513064		
Metropolis Ultimate Sport 400T	400	2019 - 2021	500868		513064		
Satelis Premium 400	400	2008 - 2011	489943		499707	520922	465837
Satelis RS 400	400	2008 - 2012	489943		499707	520922	465837
Satelis Urban 400	400	2008 - 2012	489943		499707	520922	465837
XP400 Allure	400	2023 -	500868		513064		
XP400 GT	400	2023 -	500868		513064		
Geopolis 500	500	2008 - 2013	490558	512637	499702		465842
Satelis 500	500	2007 - 2013	489943		499707	520922	465837
Satelis RS 500	500	2008 - 2012	489943		499707	520922	465837
PIAGGIO							
Beverly 125	125	2007 - 2007	489943		499707	520922	465837
Beverly B 125	125	2002 - 2006	489938	526367	499700		462573
Beverly B 125	125	2007 - 2011	489943		499707	520922	465837
Beverly B 1254Vi	125	2011 - 2014	489943		499707	520922	465837
Beverly S 125	125	2007 - 2007	489943		499707	520922	465837
Beverly Tourer 125	125	2008 - 2009	489943		499707	520922	465837
Carnaby 125	125	2007 - 2012	489943		499707	520922	465837



Modèle	Cylindre	Année	FULBAT		YUASA		Réf.
			Préconisation constructeur	Sans entretien acide	Sans entretien gel	Lithium	
Evo X7 125ie	125	2009 - 2012	489943		499707	520922	465837
Evolution X9 125	125	2003 - 2006	489938	526367	499700		462573
Evolution X9 125	125	2007 - 2007	489943		499707	520922	465837
Fly 125	125	2005 - 2011	489938	526367	499700		462573
Fly 1253V	125	2012 - 2015	489942		499705	520919	465840
Fly 125ie DT	125	2012 - 2015	489942		499705	520919	465840
Fly 125ie LEM	125	2012 - 2013			493803	520923	
GTS 125i	125	2009 - 2014	489943		499707	520922	465837
Hexagon 125	125	1994 - 1997	489938	526367	499700		462573
Hexagon LX4 125	125	1998 - 1999	493813		511537		465841
Hybrid MP3 125	125	2009 - 2012	489946		499708	520922	465838
Liberty 125	125	1998 - 2010	489938	526367	499700		462573
Liberty 1252V	125	2009 - 2013	489942		499705	520919	465840
Liberty 1253V i	125	2013 - 2015	489942		499705	520919	465840
Liberty i-get 1253V (4T)	125	2015 - 2021	489942		499705	520919	465840
Liberty i-get corporate 125 (4T)	125	2021 - 2023	489943		499707	520922	465837
Liberty S 125	125	2007 - 2008	497358		511537		467893
Medley 4T 125ie	125	2016 - 2022	489942		499705	520919	465840
Medley S 4T 125ie	125	2016 - 2022	489942		499705	520919	465840
MP3 125	125	2006 - 2011	489946		499708	520922	465838
MP3 125ie	125	2008 - 2012	489946		499708	520922	465838
Sfera 125	125	1995 - 1997	493812		513057		462571
Skipper 125	125	1994 - 1997	493812		513057		462571
Skipper LX 125	125	1998 - 1999	489938	526367	499700		462573
Skipper ST 125	125	2000 - 2004	489938	526367	499700		462573
Street X8 125	125	2006 - 2007	493813		511537		465841
Super Hexagon GTX 125	125	2000 - 2003	493813		511537		465841
Typhoon 125	125	1999 - 2015	489938	526367	499700		462573
X10 125	125	2012 - 2015	489943		499707	520922	465837
X7 125	125	2008 - 2009	489943		499707	520922	465837
X8 125	125	2004 - 2006	493813		511537		465841
X8 125ie	125	2007 - 2007	489946		499708	520922	465838
X9 125	125	2000 - 2002	493813		511537		465841
Xevo 125	125	2007 - 2016	489946		499708	520922	465838
Yourban MP3 125ie	125	2011 - 2013	489946		499708	520922	465838
Zip 125	125	2000 - 2006	489940		499706	520922	465836
Cosa 2 150	150	1991 - 1997	493812		513057		462571
Cosa CL - CLX 150	150	1988 - 1991	493812		513057		462571
Fly 150	150	2005 - 2011	489938	526367	499700		462573
Fly 150	150	2012 - 2013	489942		499705	520919	465840
Hexagon 150	150	1994 - 1997	489938	526367	499700		462573
Liberty 1502V	150	2008 - 2012	489943		499707	520922	465837
Liberty 1503V	150	2013 - 2015	489942		499705	520919	465840
Liberty i-get 1503V (4T)	150	2015 - 2020	489942		499705	520919	465840
Medley 4T 150ie	150	2016 - 2020	489942		499705	520919	465840

Modèle	Cylindre	Année	FULBAT	FULBAT	YUASA		Réf.
			Préconisation constructeur	Sans entretien acide	Sans entretien gel	Lithium	
Medley S 4T 150ie	150	2016 - 2020	489942		499705	520919	465840
Skipper 150	150	1994 - 1997	493812		513057		462571
Skipper LX 150	150	1998 - 1999	489938	526367	499700		462573
Skipper ST 150	150	2000 - 2004	489938	526367	499700		462573
X8 150	150	2006 - 2008	493813		511537		465841
Amalfi X9 180	180	2000 - 2003	493813		511537		465841
Hexagon LX 180	180	1998 - 1999	489938	526367	499700		462573
Hexagon LXT 180	180	1998 - 1999	493813		511537		465841
Super Hexagon GTX 180	180	2000 - 2003	493813		511537		465841
Beverly B 200	200	2002 - 2006	489938	526367	499700		462573
Carnaby 200	200	2007 - 2010	489946		499708	520922	465838
Cosa 2 200	200	1991 - 1997	489938	526367	499700		462573
Cosa CL - CLX 200	200	1988 - 1991	489938	526367	499700		462573
Evolution X9 200	200	2003 - 2004	493813		511537		465841
Liberty 200	200	1998 - 2007	489943		499707	520922	465837
Liberty S 200	200	2007 - 2009	489943		499707	520922	465837
X8 200	200	2004 - 2005	497358		511537		467893
X9 200	200	2002 - 2003	493813		511537		465841
Beverly 250	250	2004 - 2007	489946		499708	520922	465838
Beverly 250ie	250	2006 - 2007	489946		499708	520922	465838
Beverly Cruiser 250ie	250	2007 - 2009	489946		499708	520922	465838
Beverly S 250ie	250	2007 - 2007	489946		499708	520922	465838
Carnaby 250ie	250	2008 - 2009	489946		499708	520922	465838
Hexagon GT 250	250	1998 - 1999	493813		511537		465841
MP3 250	250	2006 - 2010	489946		499708	520922	465838
MP3 250MIC - EFI	250	2008 - 2009	489946		499708	520922	465838
MP3 LT 250ie	250	2009 - 2009	489946		499708	520922	465838
Super Hexagon 250	250	2000 - 2002	493813		511537		465841
X7 250ie	250	2008 - 2009	489946		499708	520922	465838
X8 250ie	250	2005 - 2008	489946		499708	520922	465838
X9 250	250	2000 - 2005	493813		511537		465841
X9 250	250	2004 - 2004	489943		499707	520922	465837
X9 250	250	2006 - 2007	489946		499708	520922	465838
Xevo 250ie	250	2007 - 2011	489946		499708	520922	465838
Beverly 300	300	2021 - 2022	489943		499707	520922	465837
Beverly 300ie	300	2017 - 2018	489943		499707	520922	465837
Beverly 300ie RST	300	2011 - 2014	489943		499707	520922	465837
Beverly S 300ie S	300	2014 - 2018	489943		499707	520922	465837
Beverly Tourer 300ie	300	2010 - 2015	489946		499708	520922	465838
Business MP3 LT 300ie	300	2013 - 2018	489946		499708	520922	465838
Carnaby 300ie	300	2011 - 2013	489943		499707	520922	465837
Carnaby Cruiser 300ie	300	2008 - 2011	489943		499707	520922	465837
EVO X7 300ie	300	2010 - 2012	489943		499707	520922	465837
Hybrid MP3 300ie	300	2011 - 2015	489946		499708	520922	465838
Hybrid MP3 LT 300ie	300	2011 - 2012	489946		499708	520922	465838



Modèle	Cylindre	Année	FULBAT		YUASA		Réf.
			Préconisation constructeur	Sans entretien acide	Sans entretien gel	Lithium	
MP3 300 HPE - Sport	300	2019 - 2020	489943		499707	520922	465837
MP3 LT 300ie	300	2010 - 2010	489946		499708	520922	465838
Sport MP3 LT 300ie	300	2013 - 2018	489946		499708	520922	465838
Touring MP3 300ie	300	2011 - 2012	489946		499708	520922	465838
Touring MP3 LT 300ie	300	2011 - 2012	489946		499708	520922	465838
Yourban MP3 300ie	300	2011 - 2016	489946		499708	520922	465838
Yourban MP3 LT 300ie	300	2011 - 2014	489946		499708	520922	465838
Yourban MP3 LT 300RL	300	2017 - 2018	489946		499708	520922	465838
Beverly Sport Touring 350ie	350	2011 - 2018	489943		499707	520922	465837
Beverly ST 350ie	350	2017 - 2017	489943		499707	520922	465837
Maxi Sport E4 MP3 350	350	2018 - 2020	489946		499708	520922	465838
X10 350ie	350	2012 - 2015	489943		499707	520922	465837
Beverly 400 400	400	2021 - 2022	489943		499707	520922	465837
Beverly 400ie	400	2006 - 2008	489946		499708	520922	465838
Beverly Tourer 400ie	400	2008 - 2009	489946		499708	520922	465838
MP3 400	400	2007 - 2010	490560		517782		478136
MP3 400 400	400	2021 - 2022	489943		499707	520922	465837
MP3-LT 400	400	2009 - 2010	490560		517782		478136
Touring MP3 LT 400ie	400	2011 - 2012	490560		517782		478136
Touring MP3 RL 400ie	400	2011 - 2012	490560		517782		478136
X8 400ie	400	2006 - 2008	490560		517782		478136
Xevo 400ie	400	2007 - 2012	489946		499708	520922	465838
Beverly 500	500	2006 - 2006	489946		499708	520922	465838
Beverly 500ie	500	2007 - 2012	489946		499708	520922	465838
Beverly B 500	500	2002 - 2005	489946		499708	520922	465838
Beverly Cruiser 500ie	500	2007 - 2013	489946		499708	520922	465838
Evolution X9 500	500	2003 - 2010	490558	512637	499702		465842
MP3 500 500	500	2021 - 2023	489943		499707	520922	465837
MP3 500ie	500	2009 - 2010	489946		499708	520922	465838
Touring Business MP3 500ie	500	2011 - 2012	489946		499708	520922	465838
Touring Business MP3 LT 500ie	500	2011 - 2020	489946		499708	520922	465838
Touring Sport MP3 500ie	500	2011 - 2012	489946		499708	520922	465838
Touring Sport MP3 LT 500ie	500	2011 - 2020	489946		499708	520922	465838
X10 500i	500	2012 - 2015	489943		499707	520922	465837
X9 500	500	2000 - 2002	490558	512637	499702		465842
X9 500ie	500	2007 - 2007	490558	512637	499702		465842
X9 500SL	500	2000 - 2002	490558	512637	499702		465842
RIEJU							
Aventura 125	125	2022 - 2023			491434	520921	
Century Century 125	125	2021 - 2023			491434	520921	
Marathon 125AC	125	2009 - 2020	489944		499703	520919	465835
Marathon Pro 125LC	125	2009 - 2020	489944		499703	520919	465835
Marathon Pro Competizione 125LC	125	2011 - 2014	489944		499703	520919	465835
Marathon Pro Supermotard 125LC	125	2009 - 2020	489944		499703	520919	465835

Modèle	Cylindre	Année	FULBAT	FULBAT	YUASA		Réf.
			Préconisation constructeur	Sans entretien acide	Sans entretien gel	Lithium	
Marathon Supermotard 125AC	125	2010 - 2020	489944		499703	520919	465835
MRT 125 LC	125	2022 - 2023			491434	520921	
MRT 125 Pro	125	2022 - 2023			491434	520921	
NKD RS3 125	125	2011 - 2015	489944		499703	520919	465835
Sport RS3 125	125	2011 - 2016	489944		499703	520919	465835
Tango 125	125	2011 - 2018	489944		499703	520919	465835
Tango ie 125 ie	125	2019 - 2023			491434	520921	
Tango Scrambler 125 ie	125	2020 - 2023			491434	520921	
ROYAL ENFIELD							
Classic 350	350	2022 - 2023	489940		499706	520922	465836
Himalayan 410	350	2016 - 2022	489940		499706	520922	465836
Meteor 350 Supernova	350	2021	489940		499706	520922	465836
Meteor 410	350	2020 - 2022	489940		499706	520922	465836
Scram 411	411	2022 - 2023	489940		499706	520922	465836
Bullet 500	500	2020 - 2022	499708			520922	510623
Classic 500 Pegasus	500	2018	499708			520922	510623
Classic 500 Tribute Black	500	2020	499708			520922	510623
Continental GT 535	535	2013 - 2018	490558	512637	499702		465842
Continental GT 650	650	2019 - 2022	500866		517781		
Continental GT 650 120th Anniversary	650	2022	500866		517781		
Interceptor 650	650	2019 - 2022	500866		517781		
Interceptor 650 120th Anniversary	650	2022	500866		517781		
Meteor 650 Supernova	650	2023 -	500866		517781		
SHERCO							
ADVENTURE 125 TY	125	2021 - 2023	489944		499703	520919	465835
Cross Country SC-R 125 (2T)	125	2019 - 2020	489944		499703	520919	465835
Cross Country SE-R 125 (2T)	125	2019 - 2020	489944		499703	520919	465835
Enduro Factory SE-R 125 (2T)	125	2018 - 2020	489944		499703	520919	465835
Enduro Racing SE-R 125 (2T)	125	2018 - 2020	489944		499703	520919	465835
LONG RIDE 125 TY	125	2021 - 2023	489944		499703	520919	465835
SE-RS Factory (4T)	125	2023 -	489937		489939	520919	465833
SM-RS Blackmoon (4T)	125	2023 -	489937		489939	520919	465833
SM-RS Factory (4T)	125	2023 -	489937		489939	520919	465833
Cross Country SCF-R 250 (4T)	250	2019 - 2020	489944		499703	520919	465835
Cross Country SC-R 250 (2T)	250	2019 - 2020	489944		499703	520919	465835
Enduro 2.5i 2,5i-F (4T)	250	2008 - 2008			491434	520921	
Enduro 2.5i SE 2,5i-F (4T)	250	2009 - 2011			491434	520921	
Enduro Factory SEF-R 250 (4T)	250	2017 - 2021	489944		499703	520919	465835
Enduro Factory SE-R 250 (2T)	250	2017 - 2021	489944		499703	520919	465835
Enduro Racing SEF-R 250 (4T)	250	2014 - 2020	489944		499703	520919	465835
Enduro Racing SE-R 250 (2T)	250	2014 - 2020	489944		499703	520919	465835
Enduro SE 250 (2T)	250	2014 - 2018	489944		499703	520919	465835
Enduro SE 250i-F (4T)	250	2012 - 2013	489944		499703	520919	465835
Enduro SEF 250 (4T)	250	2014 - 2018	489944		499703	520919	465835
Cross Country SCF-R 300 (4T)	300	2019 - 2020	489944		499703	520919	465835



Modèle	Cylindre	Année	FULBAT		YUASA		
			Préconisation constructeur	Sans entretien acide	Sans entretien gel	Lithium	Réf.
Cross Country SC-R 300 (2T)	300	2019 - 2020	489944		499703	520919	465835
Enduro Factory SEF-R 300 (4T)	300	2017 - 2021	489944		499703	520919	465835
Enduro Factory SE-R 300 (2T)	300	2017 - 2021	489944		499703	520919	465835
Enduro Racing SEF-R 300 (4T)	300	2014 - 2021	489944		499703	520919	465835
Enduro Racing SE-R 300 (2T)	300	2014 - 2021	489944		499703	520919	465835
Enduro SE 3.0i SE 3i-F (4T)	300	2010 - 2011			491434	520921	
Enduro SE 300 (2T)	300	2014 - 2018	489944		499703	520919	465835
Enduro SE 300i-F (4T)	300	2012 - 2013	489944		499703	520919	465835
Enduro SEF 300 (4T)	300	2014 - 2018	489944		499703	520919	465835
Cross Country SCF-R 450	450	2019 - 2020	489944		499703	520919	465835
Enduro 4.5i 4,5i	450	2004 - 2008			491434	520921	
Enduro 4.5i SE 4,5i-F	450	2009 - 2011			491434	520921	
Enduro 4.5i SE 450i-R	450	2012 - 2013			491434	520921	
Enduro Factory SEF-R 450	450	2017 - 2021	489944		499703	520919	465835
Enduro Racing SEF-R 450	450	2015 - 2020	489944		499703	520919	465835
SEF 450	450	2015 - 2018	489944		499703	520919	465835
Cross Country SCF-R 500	500	2019 - 2020	489944		499703	520919	465835
Enduro Factory SEF-R 500	500	2019 - 2021	489944		499703	520919	465835
Enduro Racing SEF-R 500	500	2019 - 2020	489944		499703	520919	465835
Enduro 5.1i 5,1i	510	2006 - 2008			491434	520921	
Enduro 5.1iF SE 5,1i-F	510	2009 - 2011			491434	520921	
Enduro SE 510i-R	510	2012 - 2013			491434	520921	
SE 5,1i F	510	2012 - 2013			491434	520921	
SUZUKI							
Burgman AN 125	125	1995 - 2008	489941		499704	520922	465834
Burgman UH 125	125	2002 - 2016	489940		499706	520922	465836
Burgman UH 125A	125	2014 - 2023	489940		499706	520922	465836
CS 125	125	1983 - 1983	493812		513057		462571
DR 125S	125	1982 - 1988	489949 489936		499699	520919	462567 483973 510611 512772
DR 125S	125	1989 - 1994	489937		489939	520919	465833
DR 125SE	125	1994 - 2001	489942		499705	520919	465840
DR 125SM	125	2008 - 2013	489942		499705	520919	465840
EN 1252	125	2005 - 2005	493812		513057		462571
EN 1252A	125	2005 - 2005	493812		513057		462571
Gamma RG 125	125	1988 - 1988	489949 489936		499699	520919	462567 483973 510611 512772
Gamma RG 125BU	125	1988 - 1988	489949 489936		499699	520919	462567 483973 510611 512772
Gamma RG 125C	125	1986 - 1990	489949 489936		499699	520919	462567 483973 510611 512772

MOTEUR

CYCLE

PNEUMATIQUE

ATELIER

ACCESSOIRES

ÉLECTRICITÉ

FILTRATION

FREINAGE

TRANSMISSION

Modèle	Cylindre	Année	FULBAT	FULBAT	Lithium	Réf.	
			Préconisation constructeur	Sans entretien acide			Sans entretien gel
Gamma RG 125F	125	1992 - 1994	489942		499705	520919	465840
Gamma RG 125FU	125	1992 - 1995	489942		499705	520919	465840
GN 125	125	1982 - 2001	493812		513057		462571
GN 125E	125	1994 - 2001	493812		513057		462571
GN 125HS	125	2000 - 2010	493812		513057		462571
GP 125	125	1978 - 1989			517776		
GS 125	125	1982 - 1984	493812		513057		462571
GS 125ES	125	1982 - 2000	493812		513057		462571
GSX-R 125	125	2017 - 2023	499703			520919	510612
GSX-S 125	125	2017 - 2023	499703			520919	510612
Intruder VL 125	125	1999 - 2008	489942		499705	520919	465840
Marauder GZ 125	125	1998 - 2011	489942		499705	520919	465840
RG 125UC	125	1986 - 1988	489949 489936		499699	520919	462567 483973 510611 512772
RV 125	125	1973 - 1976			517776		
Sixteen UX 125	125	2008 - 2014	489942		499705	520919	465840
TS 125ER	125	1982 - 1982	489949 489936		499699	520919	462567 483973 510611 512772
TS 125R	125	1990 - 1996	489937		489939	520919	465833
TS 125X	125	1984 - 1984	489949 489936		499699	520919	462567 483973 510611 512772
TS 125XU	125	1986 - 1990	489949 489936		499699	520919	462567 483973 510611 512772
TU 125	125	1999 - 1999	493812		513057		462571
UC 125	125	1999 - 2000	489941		499704	520922	465834
V125G UZ 125	125	2005 - 2005	489942		499705	520919	465840
Van-Van RV 125	125	2002 - 2017	489942		499705	520919	465840
Wolf RG 125U	125	1992 - 1995	489942		499705	520919	465840
SIXteen UX 150	150	2008 - 2014	489942		499705	520919	465840
UE 150CT	150	2001 - 2001	489941		499704	520922	465834
TS 185	185	1973 - 1976			517776		
Burgman UH 200	200	2007 - 2016	489940		499706	520922	465836
Burgman UH 200A	200	2014 - 2021	489940		499706	520922	465836
DR 200	200	1986 - 1989	489949 489936		499699	520919	462567 483973 510611 512772
DR 200SE	200	1993 - 2013	489942		499705	520919	465840
RV 200	200	2002 - 2003	489942		499705	520919	465840
TS 200R	200	1989 - 1994	489937		489939	520919	465833
Van-Van RV 200	200	2016 - 2020	489942		499705	520919	465840



Modèle	Cylindre	Année	FULBAT		YUASA	
			Préconisation constructeur	Sans entretien acide	Sans entretien gel	Lithium
X5 GT 200E	200	1979 - 1982	493812		513057	462571
LT-F4 230WDX	230	1991 - 1998	501411		513059	
Quad Runner LT 230E	230	1988 - 1993	489943		499707	520922 465837
Across GSX 250F	250	1990 - 1998	489941		499704	520922 465834
Bandit GSF 250	250	1992 - 1994	489941		499704	520922 465834
Bandit GSF 250V	250	1995 - 2000	489941		499704	520922 465834
Burgman AN 250	250	2003 - 2006	490561		517780	520922 472408 481623
Burgman AN 250	250	1998 - 1999	489941		499704	520922 465834
Burgman AN 250	250	2000 - 2002	489940		499706	520922 465836
DR 250	250	1990 - 1993	489937		489939	520919 465833
DR 250R	250	1998 - 2000	489944		499703	520919 465835
DR 250S	250	1982 - 1987	489949 489936		499699	520919 462567 483973 510611 512772
DR 250S	250	1990 - 1992	489937		489939	520919 465833
DR 250SE	250	1993 - 1995	489942		499705	520919 465840
DR-Z 250	250	2001 - 2007	489944		499703	520919 465835
GN 250	250	1985 - 1998	500870		511537	
Grass Tracker - Big Boy TU 250G	250	2000 - 2000	500870		511537	
Grass Tracker - Big Boy TU 250GB	250	2001 - 2001	500870		511537	
GS 250T	250	1980 - 1981	500870		511537	
GSX 250R	250	2017 - 2018	489940		499706	520922 465836
GT 250	250	1973 - 1978	489935		511534	520919 462568
GT 250X7	250	1978 - 1981	489935		511534	520919 462568
GZ 250	250	1999 - 2001	489942		499705	520919 465840
Inazuma GW 250	250	2013 - 2015	489940		499706	520922 465836
Intruder VL 250	250	2000 - 2007	489942		499705	520919 465840
Katana GSX 250E	250	1980 - 1982	500870		511537	
LT-F 250	250	1987 - 2001	501411		513059	
LT-F 250F	250	1999 - 2002	489943		499707	520922 465837
Marauder GZ 250	250	2002 - 2008	489942		499705	520919 465840
Ozark LT-F 250	250	2002 - 2014	489943		499707	520922 465837
Quadracer LT 250R	250	1991 - 1992	489943		499707	520922 465837
QuadSport LT-Z 250	250	2004 - 2012	489940		499706	520922 465836
RGV 250	250	1988 - 1996	489937		489939	520919 465833
Skywave AN 250M	250	2007 - 2008	489943		499707	520922 465837
Skywave AN 250S	250	2007 - 2008	489943		499707	520922 465837
Skywave AN 250SS	250	2008 - 2008	489943		499707	520922 465837
T 250	250	1970 - 1972	489935		511534	520919 462568
TS 250X	250	1984 - 1989	489949 489936		499699	520919 462567 483973 510611 512772
Volty TU 250	250	1995 - 1999	500870		511537	
Volty TU 250X	250	1995 - 2000	500870		511537	

MOTEUR

CYCLE

PNEUMATIQUE

ATELIER

ACCESSOIRES

ÉLECTRICITÉ

FILTRATION

FREINAGE

TRANSMISSION

Modèle	Cylindre	Année	FULBAT	FULBAT	YUASA		
			Préconisation constructeur	Sans entretien acide	Sans entretien gel	Lithium	Réf.
Volty TU 250X	250	2009 - 2016	489942		499705	520919	465840
V-strom DL 250A	250	2017 - 2021	489940		499706	520922	465836
LT-F 300	300	1988 - 1998	501411		513059		
LT-F 300F	300	1999 - 2002	501411		513059		
LT-F 300X	300	1987 - 1987	501411		513059		
DR 350S	350	1990 - 1993	489937		489939	520919	465833
DR 350SE	350	1994 - 1999	489942		499705	520919	465840
T 350	350	1969 - 1972	489935		511534	520919	462568
GT 380	380	1972 - 1977	493812		513057		462571
AN 400	400	2003 - 2006	490561		517780	520922	472408 481623
AN 400	400	2001 - 2002	489940		499706	520922	465836
Bandit GSF 400	400	1989 - 1997	489940		499706	520922	465836
Burgman AN 400	400	1999 - 2000	489940		499706	520922	465836
Burgman AN 400	400	2007 - 2015	499706			520922	510617
Burgman AN 400A	400	2007 - 2023	499706			520922	510617
Burgman Executive AN 400Z	400	2009 - 2016	499706			520922	510617
Burgman Executive AN 400ZA	400	2009 - 2016	499706			520922	510617
DR-Z 400	400	2000 - 2007	491434			520921	488128 510616
DR-Z 400E	400	2000 - 2007	491434			520921	488128 510616
DR-Z 400S	400	2000 - 2014	491434			520921	488128 510616
DR-Z 400SE	400	2001 - 2001	491434			520921	488128 510616
DR-Z 400SM	400	2005 - 2009	491434			520921	488128 510616
Eiger LT-A 400F	400	2002 - 2007	489946		499708	520922	465838
Eiger LT-F 400	400	2002 - 2007	489946		499708	520922	465838
Eiger LT-F 400F	400	2002 - 2007	489946		499708	520922	465838
GS 400	400	1977 - 1978	500870		511537		
GSR 400	400	2006 - 2006	489940		499706	520922	465836
GSX 400E	400	1980 - 1982	500870		511537		
GSX 400E-S	400	1982 - 1987	500870		511537		
GSX 400F	400	1981 - 1998	500870		511537		
GSX-R 400R	400	1990 - 1995	489940		499706	520922	465836
Impulse GSX 400	400	1994 - 1999	497358		511537		467893
Impulse GSX 400X	400	1988 - 1993	497358		511537		467893
King Quad Auto LT-A 400F	400	2008 - 2012	489946		499708	520922	465838
King Quad LT-F 400F	400	2008 - 2012	489946		499708	520922	465838
LT-Z 400	400	2002 - 2018	489940		499706	520922	465836
GS 425	425	1979 - 1980	500870		511537		
GS 450E	450	1980 - 1988	500870		511537		
GS 450L	450	1980 - 1987	500870		511537		
Kingquad LT-A 450X	450	2007 - 2010	489946		499708	520922	465838
Quadracer LT-R 450	450	2006 - 2012	489941		499704	520922	465834



Modèle	Cylindre	Année	FULBAT		YUASA		
			Préconisation constructeur	Sans entretien acide	Sans entretien gel	Lithium	Réf.
RM-X 450Z	450	2010 - 2017	493802			520919	483662
Gamma RG 500	500	1986 - 1989	489944		499703	520919	465835
GS 500	500	2001 - 2007	500870		511537		
GS 500E	500	1982 - 2000	500870		511537		
GS 500F	500	2004 - 2008	497358		511537		467893
GT 500	500	1976 - 1977	493812		513057		462571
LT-A 500F	500	2002 - 2003	490560		517782		478136
LT-A 500F	500	2004 - 2007	500868		513064		
LT-A 500XP	500	2010 - 2016	500868		513064		
LT-F 500F	500	1998 - 2002			517782		
Quad Master LT-A 500F	500	2000 - 2001			517782		
T 500	500	1968 - 1975	493812		513057		462571
Vinson Quadrunner LT-F 500F	500	2003 - 2003	490560		517782		478136
Vinson Quadrunner LT-F 500F	500	2004 - 2007	500868		513064		
GS 550D	550	1977 - 1978	500870		511537		
GS 550E	550	1978 - 1982	500870		511537		
GS 550ES	550	1983 - 1986	493813		511537		465841
GS 550L	550	1980 - 1982	500870		511537		
GS 550L	550	1983 - 1986	493813		511537		465841
GS 550M	550	1981 - 1982	500870		511537		
GSX 550EF	550	1984 - 1986			511537		
GSX 550ES	550	1983 - 1987			511537		
GT 550	550	1972 - 1977	500870		511537		
Bandit GSF 600	600	1995 - 2004	489940		499706	520922	465836
Bandit GSF 600S	600	1996 - 2004	489940		499706	520922	465836
GSR 600	600	2006 - 2010	489940		499706	520922	465836
GSX 600F	600	1985 - 1997	497358		511537		467893
GSX 600F	600	1998 - 2006	489940		499706	520922	465836
GSX-R 600	600	1997 - 2017	489940		499706	520922	465836
RF 600R	600	1993 - 1997	489940		499706	520922	465836
UV 620F	620	2005 - 2005	489948		499709	520924	
Bandit GSF 650N	650	2005 - 2015	489940		499706	520922	465836
Bandit GSF 650S	650	2005 - 2015	489940		499706	520922	465836
Burgman AN 650	650	2003 - 2017	489946		499708	520922	465838
Burgman AN 650A	650	2017 - 2018	489946		499708	520922	465838
Burgman Executive AN 650A	650	2004 - 2012	489946		499708	520922	465838
Burgman Executive AN 650Z	650	2013 - 2018	489946		499708	520922	465838
DR 650R	650	1990 - 1991	489935		511534	520919	462568
DR 650R	650	1992 - 1993	489937		489939	520919	465833
DR 650RE	650	1994 - 1995	489943		499707	520922	465837
DR 650RS	650	1990 - 1991	489935		511534	520919	462568
DR 650RSE	650	1991 - 1996	489946		499708	520922	465838
DR 650SE	650	1996 - 2006	489940		499706	520922	465836
Freewind XF 650	650	1997 - 2002	489940		499706	520922	465836

MOTEUR

CYCLE

PNEUMATIQUE

ATELIER

ACCESSOIRES

ÉLECTRICITÉ

FILTRATION

FREINAGE

TRANSMISSION

Modèle	Cylindre	Année	FULBAT		FULBAT		YUASA
			Préconisation constructeur	Sans entretien acide	Sans entretien gel	Lithium	Réf.
Gladius SFV 650	650	2009 - 2016	490561		517780	520922	472408 481623
Gladius SFV 650A	650	2009 - 2016	490561		517780	520922	472408 481623
GR 650	650	1983 - 1985	490558	512637	499702		465842
GSX 650F	650	2008 - 2016	489940		499706	520922	465836
GSX 650FA	650	2008 - 2016	489940		499706	520922	465836
Katana GS 650G	650	1981 - 1983	490558	512637	499702		465842
Savage LS 650F	650	1986 - 1988		512637	499702		
Savage LS 650P	650	1989 - 1999		512637	499702		
Scrambler SV 650A	650	2017 - 2020	490561		517780	520922	472408 481623
SV 650A	650	2016 - 2023	490561		517780	520922	472408 481623
SV 650N	650	1999 - 2002	490561		517780	520922	472408 481623
SV 650N	650	2003 - 2010	489943		499707	520922	465837
SV 650NA	650	2007 - 2010	490561		517780	520922	472408 481623
SV 650S	650	1999 - 2002	490561		517780	520922	472408 481623
SV 650S	650	2003 - 2011	489943		499707	520922	465837
SV 650SA	650	2007 - 2013	490561		517780	520922	472408 481623
SV 650XA Caf, Racer	650	2017 - 2023	490561		517780	520922	472408 481623
Turbo XN 85	650	1983 - 1983	490558	512637	499702		465842
V-Strom XT DL 650XA	650	2015 - 2023	489943		499707	520922	465837
V-Strom DL 650	650	2004 - 2006	489943		499707	520922	465837
V-Strom DL 650A	650	2007 - 2023	489943		499707	520922	465837
V-Strom DL 650X	650	2007 - 2011	489943		499707	520922	465837
V-Strom Traveller DL 650A	650	2007 - 2011	489943		499707	520922	465837
V-Strom Xpedition DL 650A	650	2011 - 2011	489943		499707	520922	465837
GS 700E	700	1985 - 1985	490558	512637	499702		465842
King Quad LT-A 700X	700	2005 - 2007	500868		513064		
DR 750S	750	1988 - 1989		512637	499702		
GS 750	750	1977 - 1977	490558	512637	499702		465842
GS 750D	750	1977 - 1978	490558	512637	499702		465842
GS 750E	750	1978 - 1979	490558	512637	499702		465842
GSR 750	750	2011 - 2016	490561		517780	520922	472408 481623
GSR 750A	750	2012 - 2017	490561		517780	520922	472408 481623
GSX 750E	750	1980 - 1982	490558	512637	499702		465842
GSX 750EF	750	1984 - 1985	490558	512637	499702		465842
GSX 750ES	750	1983 - 1989	490558	512637	499702		465842
GSX 750F	750	1989 - 1997		512637	499702		



Modèle	Cylindre	Année	FULBAT		FULBAT		YUASA
			Préconisation constructeur	Sans entretien acide	Sans entretien gel	Lithium	Réf.
GSX 750F	750	1998 - 2006	489940		499706	520922	465836
GSX 750S	750	1984 - 1984	490558	512637	499702		465842
GSX-R 750	750	1985 - 1991	490558	512637	499702		465842
GSX-R 750	750	2000 - 2017	490561		517780	520922	472408 481623
GSX-R 750	750	1996 - 1999	489940		499706	520922	465836
GSX-R 750R	750	1986 - 1989	490558	512637	499702		465842
GSX-R 750R SP	750	1992 - 1995	489940		499706	520922	465836
GSX-R 750W	750	1992 - 1995	489940		499706	520922	465836
GSX-S 750	750	2015 - 2015	490561		517780	520922	472408 481623
GSX-S 750A	750	2015 - 2021	490561		517780	520922	472408 481623
GSX-S 750AZ MotoGP	750	2018 - 2019	490561		517780	520922	472408 481623
GT 750	750	1972 - 1977	490558	512637	499702		465842
Inazuma GSX 750	750	1998 - 2003	489940		499706	520922	465836
Katana GSX 750S2	750	1984 - 1984	490558	512637	499702		465842
Katana GSX 750SE	750	1985 - 1985	490558	512637	499702		465842
King Quad LT-A 750X	750	2008 - 2013	500868		513064		
LT-A 750XP	750	2009 - 2016	500868		513064		
DR 800S	800	1989 - 1990		512637	499702		
DR 800S	800	1991 - 1996	489946		499708	520922	465838
Intruder VL 800	800	2005 - 2017	489943		499707	520922	465837
Intruder VL 800C	800	2007 - 2014	489943		499707	520922	465837
Intruder Volusia VL 800	800	2001 - 2004	489943		499707	520922	465837
Intruder VZ 800	800	2005 - 2017	489943		499707	520922	465837
Intruder VZ 800Z	800	2009 - 2010	489943		499707	520922	465837
Marauder VZ 800	800	1997 - 2004	489943		499707	520922	465837
GS 850G	850	1979 - 1986	490558	512637	499702		465842
RF 900R	900	1994 - 1999	489940		499706	520922	465836
GSX-950S	950	2021 - 2023	490561		517780	520922	472408 481623
Evo GSX-S1000A	1000	2018 - 2018	490561		517780	520922	472408 481623
GS 1000E	1000	1978 - 1980	490558	512637	499702		465842
GS 1000G	1000	1980 - 1981	490558	512637	499702		465842
GS 1000H	1000	1978 - 1978	490558	512637	499702		465842
GS 1000S	1000	1979 - 1979	490558	512637	499702		465842
GSX-R 1000	1000	2005 - 2018	490561		517780	520922	472408 481623
GSX-R 1000	1000	2001 - 2004	489943		499707	520922	465837
GSX-R 1000	1000	2017 - 2022	490331			520922	483849
GSX-R 1000A	1000	2015 - 2019	490561		517780	520922	472408 481623
GSX-R 1000R	1000	2017 - 2017	490561		517780	520922	472408 481623

MOTEUR

CYCLE

PNEUMATIQUE

ATELIER

ACCESSOIRES

ÉLECTRICITÉ

FILTRATION

FREINAGE

TRANSMISSION

Modèle	Cylindre	Année	FULBAT		YUASA		Réf.
			Préconisation constructeur	Sans entretien acide	Sans entretien gel	Lithium	
GSX-R 1000R	1000	2018 - 2022	490331			520922	483849
GSX-R 1000R 100th Anniversary France GSX-R 1000R	1000	2021	490331			520922	483849
GSX-R 1000R Legend Edition GSX-R 1000R	1000	2021	490331			520922	483849
GSX-R 1000R Phantom GSX-R 1000R	1000	2021	490331			520922	483849
GSX-R 1000Z	1000	2013 - 2013	490561		517780	520922	472408 481623
GSX-S 1000	1000	2015 - 2019	490561		517780	520922	472408 481623
GSX-S 1000 GSX-S1000	1000	2021 - 2023	490561		517780	520922	472408 481623
GSX-S 1000A	1000	2016 - 2023	490561		517780	520922	472408 481623
GSX-S 1000FA	1000	2016 - 2020	490561		517780	520922	472408 481623
Katana Candy Darling Red GSX 1000S	1000	2021 - 2023	490561		517780	520922	472408 481623
Katana GSX 1000S	1000	1982 - 1982	490558	512637	499702		465842
Katana GSX 1000S	1000	2019 - 2021	490561		517780	520922	472408 481623
Katana Royal Serie GSX 1000S	1000	2021 - 2023	490561		517780	520922	472408 481623
Katana S GSX 1000S	1000	2019 - 2023	490561		517780	520922	472408 481623
Katana Yoshimura Edition GSX 1000S	1000	2020 - 2020	490561		517780	520922	472408 481623
SV 1000N	1000	2003 - 2007	489946		499708	520922	465838
SV 1000S	1000	2003 - 2007	489946		499708	520922	465838
TL 1000R	1000	1998 - 2002	490561		517780	520922	472408 481623
TL 1000S	1000	1997 - 2001	489943		499707	520922	465837
V-Strom XT DL 1000XA	1000	2017 - 2021	489946		499708	520922	465838
V-Strom DL 1000	1000	2002 - 2011	489946		499708	520922	465838
V-Strom DL 1000A	1000	2014 - 2021	489946		499708	520922	465838
V-Strom 1050 DL 1050	1050	2020 - 2023			490556	520922	
V-Strom 1050 XT DL 1050XT	1050	2020 - 2023			490556	520922	
GS 1100E	1100	1980 - 1983	490558	512637	499702		465842
GS 1100ES	1100	1982 - 1983	490558	512637	499702		465842
GS 1100G	1100	1982 - 1982	490558	512637	499702		465842
GSX 1100E	1100	1980 - 1982	490558	512637	499702		465842
GSX 1100EF	1100	1984 - 1985	490558	512637	499702		465842
GSX 1100ES	1100	1983 - 1984	490558	512637	499702		465842
GSX 1100F	1100	1987 - 1994		512637	499702		
GSX 1100G	1100	1991 - 1996	489946		499708	520922	465838
GSX 1100L	1100	1980 - 1980	490558	512637	499702		465842
GSX-R 1100	1100	1986 - 1992	490558	512637	499702		465842
GSX-R 1100W	1100	1993 - 1998	489943		499707	520922	465837
Katana GSX 1100S	1100	1982 - 1983	490558	512637	499702		465842



Modèle	Cylindre	Année	FULBAT		YUASA		Réf.
			Préconisation constructeur	Sans entretien acide	Sans entretien gel	Lithium	
Bandit GSF 1200A	1200	2006 - 2006	489943		499707	520922	465837
Bandit GSF 1200N	1200	1996 - 2006	489943		499707	520922	465837
Bandit GSF 1200S	1200	1996 - 2006	489943		499707	520922	465837
Bandit GSF 1200SA	1200	1997 - 2006	489943		499707	520922	465837
GS 1200SS	1200	2001 - 2001	489943		499707	520922	465837
Inazuma GSX 1200FS	1200	1998 - 2000	489943		499707	520922	465837
Madura GV 1200GLF	1200	1985 - 1986		512637	499702		
Madura GV 1200GLG	1200	1985 - 1986		512637	499702		
Bandit GSF 1250N	1250	2007 - 2012	490561		517780	520922	472408 481623
Bandit GSF 1250S	1250	2007 - 2010	490561		517780	520922	472408 481623
Bandit GSF 1250SA	1250	2007 - 2016	490561		517780	520922	472408 481623
GSX 1250FA	1250	2010 - 2016	490561		517780	520922	472408 481623
ST Traveller GSX 1250FA	1250	2010 - 2015	490561		517780	520922	472408 481623
B-King GSX 1340BK	1300	2008 - 2012	489943		499707	520922	465837
Hayabusa GSX1300RRQ	1300	2021 - 2023			490556	520922	
Hayabusa GSX-R 1300R	1300	1999 - 2007	490561		517780	520922	472408 481623
Hayabusa GSX-R 1340R	1300	2008 - 2012	489943		499707	520922	465837
Hayabusa GSX-R 1340RA	1300	2013 - 2017	489943		499707	520922	465837
Hayabusa GSX-R 1340RA	1340	2021 - 2023			490556	520922	
GSX 1400	1400	2001 - 2007	489946		499708	520922	465838
Intruder VS 1400GL	1400	1987 - 2003			517782		
Intruder Legendry Classic VL 1500	1500	1998 - 2003			517782		
Intruder VL 1500	1500	2005 - 2011			517782		
Intruder VL 1500	1500	2013 - 2017	500868		513064		
Marauder VZ 1600	1600	2004 - 2005	500868		513064		
Intruder VLR 1800	1800	2008 - 2011	500868		513064		
Intruder VLR 1800RT	1800	2008 - 2009	500868		513064		
Intruder VZR 1800BZ	1800	2014 - 2017	500868		513064		
Intruder VZR 1800R	1800	2006 - 2017	500868		513064		
Intruder VZR 1800R2N	1800	2008 - 2009	500868		513064		
VZR 1800RZ	1800	2007 - 2013	500868		513064		
SWM							
Ace of Spades 125	125	2022 - 2023	493802			520919	483662
Naked 125 ABS	125	2022 - 2023	493802			520919	483662
Outlaw R 125 CBS	125	2022 - 2023	493802			520919	483662
SM 125R	125	2022 - 2023	493802			520919	483662
RS 300R	300	2015 - 2023	493802			520919	483662
RS 500R	500	2015 - 2023	493802			520919	483662
SM 500R	500	2016 - 2023	493802			520919	483662
SYM							
Allo 125 (4T)	125	2011 - 2015	489941		499704	520922	465834

Modèle	Cylindre	Année	FULBAT	FULBAT	Lithium	Réf.	
			Préconisation constructeur	Sans entretien acide			Sans entretien gel
City Com 125	125	2008 - 2013	489940		499706	520922	465836
ComBiz 125	125	2011 - 2014	489941		499704	520922	465834
Cruisym Alpha 125i E5 125i	125	2021 - 2022	489940		499706	520922	465836
Euro 1 MX 125	125	2002 - 2007	489940		499706	520922	465836
Euro 2 MX 125	125	2006 - 2009	489940		499706	520922	465836
Evo HD 125i	125	2007 - 2013	489940		499706	520922	465836
Evo HD 125S	125	2007 - 2007	489940		499706	520922	465836
Fiddle II 125 (4T)	125	2008 - 2015	489941		499704	520922	465834
Fiddle III 125 (4T)	125	2008 - 2015	489941		499704	520922	465834
Fiddle IV 125 LC 125 E5	125	2021 - 2022	499704			520922	510613
FNX 125 125	125	2021	499704			520922	510613
FNX GC12G2	125	- 2015	499704			520922	510613
GTS 125	125	2006 - 2007	489940		499706	520922	465836
GTS 125Euro 3	125	2008 - 2008	489940		499706	520922	465836
GTS 125EVO	125	2009 - 2010	489940		499706	520922	465836
HD 125	125	2004 - 2009	489940		499706	520922	465836
HD2 125i	125	2010 - 2015	489940		499706	520922	465836
JET 14 125i	125	2017 - 2017	489941		499704	520922	465834
JET 14 AIR COOL, LC ABS 125	125	2021 - 2022	499704			520922	510613
Jet 4 125	125	2010 - 2017	489941		499704	520922	465834
Jet V 125	125	2012 - 2013	490331			520922	483849
JET X 125 ABS 125	125	2021 - 2022			490331	520922	
Joymax GTS 125i	125	2010 - 2015	489940		499706	520922	465836
Joymax Z+ 125i E5 125i	125	2021 - 2022	489940		499706	520922	465836
Joyride 125	125	2001 - 2006	489940		499706	520922	465836
Joyride 125i	125	2007 - 2009	489940		499706	520922	465836
Joyride Evo 125i	125	2009 - 2015	489940		499706	520922	465836
Megalo 125	125	2000 - 2007	489941		499704	520922	465834
NH-T 125 125	125	2021 - 2022	499704			520922	510613
NH-X 125 125	125	2021 - 2022	499704			520922	510613
Orbit II Symply 4T 125	125	2009 - 2015	489941		499704	520922	465834
RS 125	125	2004 - 2006	489940		499706	520922	465836
Shark 125	125	1999 - 2002	489940		499706	520922	465836
Shark 4VR 125R	125	2000 - 2002	489940		499706	520922	465836
Sport GTS 125i	125	2014 - 2015	489940		499706	520922	465836
Symphony 125SR	125	2010 - 2015	489941		499704	520922	465834
Symphony S 125	125	2010 - 2015	489941		499704	520922	465834
Symphony S 125	125	2021	499704			520922	510613
Symphony ST 125	125	2021 - 2022	499704			520922	510613
VS 125	125	2006 - 2015	490331			520922	483849
Wolf SB 125Ni	125	2011 - 2015	489940		499706	520922	465836
XPro 125	125	2013 - 2015	489941		499704	520922	465834
XPro 125	125	2021 - 2023	499704			520922	510613
Evo HD 200S	200	2007 - 2007	489940		499706	520922	465836
HD2 200i (4T)	200	2010 - 2015	489940		499706	520922	465836



Modèle	Cylindre	Année	FULBAT		YUASA		Réf.
			Préconisation constructeur	Sans entretien acide	Sans entretien gel	Lithium	
Joyride 200	200	2003 - 2007	489940		499706	520922	465836
Joyride 200i	200	2007 - 2009	489940		499706	520922	465836
Joyride Evo 200i	200	2009 - 2015	489940		499706	520922	465836
Trackrunner 200	200	2005 - 2009	489940		499706	520922	465836
Joymax 250i	250	2007 - 2008	489943		499707	520922	465837
Joymax GTS 250i	250	2009 - 2014	489943		499707	520922	465837
Quadlander 250	250	2005 - 2009	489943		499707	520922	465837
Wolf SB 250Ni	250	2012 - 2015	490561		517780	520922	472408 481623
City Com 300i	300	2008 - 2014	489943		499707	520922	465837
CRUISYM 300	300	2017 - 2017	490561		517780	520922	472408 481623
Cruisym Alpha 300i E5 300i	300	2021 - 2022	490561		517780	520922	472408 481623
Joymax Evo GTS 300i	300	2010 - 2013	490561		517780	520922	472408 481623
Joymax GTS 300	300	2008 - 2014	489943		499707	520922	465837
Joymax Z+ 300i E5 300i	300	2021 - 2022	490561		517780	520922	472408 481623
Quadlander 300	300	2008 - 2010	489943		499707	520922	465837
Quadlander 300S	300	2007 - 2015	489943		499707	520922	465837
Sport GTS 300	300	2014 - 2015	489943		499707	520922	465837
MaxSym 400 400 E5	400	2021 - 2022	490331			520922	483849
MaxSym 400i	400	2011 - 2015	490556			520922	490512
MaxSym 508 TL 508 E5	500	2021 - 2022	490331			520922	483849
MaxSym 600i	600	2014 - 2015	490556			520922	490512
T.M.							
Enduro EN 250	250	2010 - 2017	489942		499705	520919	465840
Enduro EN 250F (4T)	250	2009 - 2010	489942		499705	520919	465840
Enduro EN 250Fi (4T)	250	2011 - 2016	489942		499705	520919	465840
EN 300	300	2010 - 2017	489942		499705	520919	465840
EN 450F	450	2003 - 2010	489942		499705	520919	465840
EN 450Fi	450	2011 - 2016	489942		499705	520919	465840
EN 530F	530	2004 - 2016	489942		499705	520919	465840
MX 530F	530	2005 - 2015	489942		499705	520919	465840
TRIUMPH							
Daytona 600	600	2003 - 2004	489940		499706	520922	465836
Speedfour 600	600	2002 - 2005	489943		499707	520922	465837
TT 600	600	2000 - 2003	489943		499707	520922	465837
Daytona 650	650	2005 - 2005	489940		499706	520922	465836
T 120	650	1966 - 1970			511535	520919	
Tiger Sport 660	660	2022 - 2023	499706			520922	510617
Trident 660 660	660	2020 - 2023	490558	512637	499702		465842
Daytona 675	675	2006 - 2010			491434	520921	
Daytona 675	675	2011 - 2016	489940		499706	520922	465836
Daytona 675R	675	2011 - 2017	489940		499706	520922	465836

MOTEUR

CYCLE

PNEUMATIQUE

ATELIER

ACCESSOIRES

ÉLECTRICITÉ

FILTRATION

FREINAGE

TRANSMISSION

Modèle	Cylindre	Année	FULBAT	FULBAT	Lithium	Réf.	
			Préconisation constructeur	Sans entretien acide			Sans entretien gel
Street Triple 675	675	2007 - 2016	489940		499706	520922	465836
Street Triple 675R	675	2009 - 2016	489940		499706	520922	465836
Street Triple 675RX	675	2015 - 2016	489940		499706	520922	465836
Bonneville Harris T 140	750	1985 - 1988	489938	526367	499700		462573
Bonneville T 140D	750	1979 - 1981	489938	526367	499700		462573
Bonneville T 140E	750	1978 - 1983	489938	526367	499700		462573
Bonneville T 140V	750	1973 - 1978	489938	526367	499700		462573
Daytona 750	750	1991 - 1993	490558	512637	499702		465842
Executive T 140E ES	750	1981 - 1983	489938	526367	499700		462573
Silver Jubilee Bonneville T 140	750	1977 - 1977	489938	526367	499700		462573
T 140ES	750	1980 - 1981	489938	526367	499700		462573
Trident 750	750	1991 - 1998	490558	512637	499702		465842
Street Triple 765 Moto2 Edition	765	2023 -	489940		499706	520922	465836
Street Triple R 765	765	2017 - 2023	489940		499706	520922	465836
Street Triple RS 765	765	2017 - 2023	489940		499706	520922	465836
Street Triple S 765	765	2017 - 2021	489940		499706	520922	465836
Bonneville 800	800	2001 - 2006	489943		499707	520922	465837
Bonneville America 800	800	2002 - 2006	489943		499707	520922	465837
Bonneville T 100	800	2001 - 2006	489943		499707	520922	465837
Speedmaster 800	800	2003 - 2005	489943		499707	520922	465837
Tiger 800	800	2011 - 2014	490560		517782		478136
Tiger 800XC	800	2011 - 2021	490560		517782		478136
Tiger 800XCa	800	2015 - 2021	490560		517782		478136
Tiger 800XCx	800	2015 - 2021	490560		517782		478136
Tiger 800XR	800	2015 - 2021	490560		517782		478136
Tiger 800XRt	800	2015 - 2021	490560		517782		478136
Tiger 800XRx	800	2015 - 2021	490560		517782		478136
Tiger 850 Sport 888	850	2021 - 2023	489946		499708	520922	465838
Speed Triple T 309	855	1994 - 1997	490558	512637	499702		465842
America ->694349 900	865	2014 - 2014	489943		499707	520922	465837
America ->694349 900LT	865	2014 - 2014	489943		499707	520922	465837
America 694350 -> 900	865	2015 - 2017	489943		499707	520922	465837
America 900	865	2007 - 2010			493803	520923	
America 900	865	2010 - 2013	489943		499707	520922	465837
Bonneville 694352 -> T100 900	865	2015 - 2016			493803	520923	
Bonneville 694352 -> T100 900	865	2015 - 2015	489943		499707	520922	465837
Bonneville -> 694351 900	865	2014 - 2014	489943		499707	520922	465837
Bonneville ->694351 T100 900	865	2014 - 2014			493803	520923	
Bonneville 694352 -> 900	865	2015 - 2016	489943		499707	520922	465837
Bonneville 900	865	2004 - 2010			493803	520923	
Bonneville 900	865	2010 - 2013	489943		499707	520922	465837
Bonneville 900SE	865	2009 - 2012	489943		499707	520922	465837
Bonneville Black ->694351 T100 900	865	2014 - 2014			493803	520923	
Bonneville Black 694352 -> T100 900	865	2015 - 2015	489943		499707	520922	465837



Modèle	Cylindre	Année	FULBAT		YUASA		
			Préconisation constructeur	Sans entretien acide	Sans entretien gel	Lithium	Réf.
Bonneville Black 900	865	2007 - 2008			493803	520923	
Bonneville New Church 694352 -> 900	865	2015 - 2016	489943		499707	520922	465837
Bonneville Spirit 694352 -> 900	865	2015 - 2015	489943		499707	520922	465837
Bonneville Steve Mc Queen T100 900	865	2013 - 2013	489943		499707	520922	465837
Bonneville Steve McQueen 900SE	865	2012 - 2012	489943		499707	520922	465837
Bonneville T100 900	865	2004 - 2013	489943		499707	520922	465837
Bonneville T214 900	865	2015 - 2015	489943		499707	520922	465837
Scrambler 694350 -> 900	865	2015 - 2017	489943		499707	520922	465837
Scrambler 900	865	2006 - 2010			493803	520923	
Scrambler 900	865	2010 - 2013	489943		499707	520922	465837
Speedmaster -> 694386 900	865	2014 - 2014	489943		499707	520922	465837
Speedmaster 694350 -> 900	865	2015 - 2017	489943		499707	520922	465837
Speedmaster 900	865	2005 - 2010			493803	520923	
Speedmaster 900	865	2010 - 2013	489943		499707	520922	465837
Thruxton ->694349 900	865	2014 - 2014	489943		499707	520922	465837
Thruxton 694350 -> 900	865	2015 - 2016	489943		499707	520922	465837
Thruxton 900	865	2004 - 2010			493803	520923	
Thruxton 900	865	2011 - 2013	489943		499707	520922	465837
Thruxton Ace 694350 -> 900	865	2015 - 2015	489943		499707	520922	465837
Speed Triple T 509	885	1997 - 2001	490558	512637	499702		465842
Adventurer 885	900	1996 - 2001	490558	512637	499702		465842
Bonneville T100 900	900	2017 - 2021	489943		499707	520922	465837
Bonneville T100 900 Black	900	2017 - 2023	489943		499707	520922	465837
Bonneville T100 900 Chrome Edition	900	2022 - 2023	489943		499707	520922	465837
Bonneville T100 900 Gold Line	900	2022 - 2023	489943		499707	520922	465837
Daytona 900	900	1993 - 1997	490558	512637	499702		465842
Daytona Super III 900	900	1994 - 1997	490558	512637	499702		465842
Legend TT 885	900	1998 - 2001	490558	512637	499702		465842
Speed Triple 885	900	1994 - 1996	490558	512637	499702		465842
Speed Twin 900	900	2021 - 2023	490331			520922	483849
Speed Twin 900 Chrome Edition	900	2021 - 2023	490331			520922	483849
Speed Twin 900 EC1	900	2021 - 2023	490331			520922	483849
Speed Twin 900 Gold Line	900	2021 - 2023	490331			520922	483849
Sprint 900	900	1993 - 1998	490558	512637	499702		465842
Sprint Executive 900	900	1997 - 1998	490558	512637	499702		465842
Street Cup 900	900	2017 - 2021	489943		499707	520922	465837
Street Scrambler 900	900	2017 - 2021	489943		499707	520922	465837
Street Twin 900	900	2016 - 2021	489943		499707	520922	465837
Thunderbird 885	900	1995 - 2003	490558	512637	499702		465842
Thunderbird Sport 885	900	1998 - 2004	490558	512637	499702		465842
Tiger 855i	900	1998 - 1998	490558	512637	499702		465842
Tiger 855i	900	1999 - 1999	489946		499708	520922	465838
Tiger 885	900	1992 - 1998	490558	512637	499702		465842
Tiger 885	900	1999 - 1999	489946		499708	520922	465838

Modèle	Cylindre	Année	FULBAT	FULBAT	Lithium	Réf.
			Préconisation constructeur	Sans entretien acide		
Tiger 900	900	2020 - 2021	490556		520922	490512
Tiger GT 900	900	2020 - 2023	490556		520922	490512
Tiger GT Pro 900	900	2020 - 2023	490556		520922	490512
Tiger Rally 900	900	2020 - 2023	490556		520922	490512
Tiger Rally Pro 900	900	2020 - 2023	490556		520922	490512
Trident 900	900	1992 - 1998	490558	512637	499702	465842
Trident TT 900	900	1991 - 1991	490558	512637	499702	465842
Trophy 900	900	1991 - 2001	490558	512637	499702	465842
Daytona 955i	955	1998 - 2006	489946		499708	520922
Daytona T 595	955	1997 - 1998	489946		499708	520922
Speed Triple 955	955	2002 - 2004	489946		499708	520922
Speed Triple T 509	955	1997 - 1998	490558	512637	499702	465842
Speed Triple T 509	955	1999 - 2001	489946		499708	520922
Sprint 955RS	955	2003 - 2004	489946		499708	520922
Sprint 955ST	955	1999 - 2004	489946		499708	520922
Sprint RS 955	955	1999 - 2002	489946		499708	520922
Tiger 955	955	1999 - 2006	489946		499708	520922
Daytona 1000	1000	1991 - 1992	490558	512637	499702	465842
Trophy 1000	1000	1992 - 1992	490558	512637	499702	465842
Speed Triple 1050	1050	2005 - 2013	489943		499707	520922
Speed Triple 1050	1050	2014 - 2016	489946		499708	520922
Speed Triple 1050R	1050	2012 - 2017	489946		499708	520922
Speed Triple 1050RS	1050	2018 - 2019	489946		499708	520922
Speed Triple 1050S	1050	2017 - 2017	489946		499708	520922
Speed Triple 1050T	1050	2012 - 2012	489943		499707	520922
Speed Triple 1050T	1050	2013 - 2014	489946		499708	520922
Sprint 1050GT	1050	2010 - 2016	489946		499708	520922
Sprint 1050ST	1050	2005 - 2010	489943		499707	520922
Sprint ST 1050i	1050	2011 - 2012	489943		499707	520922
Tiger 1050	1050	2007 - 2012	489943		499707	520922
Tiger 1050SE	1050	2010 - 2013	489943		499707	520922
Tiger Sport 1050	1050	2013 - 2017	489946		499708	520922
Bonneville Bobber 1200	1200	2017 - 2023	489940		499706	520922
Bonneville Bobber 1200 Chrome Edition	1200	2022 - 2023	489940		499706	520922
Bonneville Bobber 1200 Gold Line	1200	2022 - 2023	489940		499706	520922
Bonneville Bobber Black 1200	1200	2018 - 2021	489940		499706	520922
Bonneville Bobber TFC 1200	1200	2020 - 2021	489940		499706	520922
Bonneville Speedmaster 1200	1200	2021 - 2023	489940		499706	520922
Bonneville Speedmaster 1200 Chrome Edition	1200	2022 - 2023	489940		499706	520922
Bonneville Speedmaster 1200 Gold Line	1200	2022 - 2023	489940		499706	520922
Bonneville T120 1200	1200	2016 - 2023	489943		499707	520922
Bonneville T120 1200 Black	1200	2016 - 2023	489943		499707	520922
Bonneville T120 1200 Black Gold Line	1200	2022 - 2023	489943		499707	520922
Bonneville T120 1200 Chrome Edition	1200	2022 - 2023	489943		499707	520922



Modèle	Cylindre	Année	FULBAT		FULBAT		YUASA
			Préconisation constructeur	Sans entretien acide	Sans entretien gel	Lithium	Réf.
Bonneville T120 1200 DGR Limited Edition	1200	2022 - 2023	489943		499707	520922	465837
Bonneville T120 1200 Gold Line	1200	2022 - 2023	489943		499707	520922	465837
Daytona 1200	1200	1993 - 1998	490558	512637	499702		465842
Scrambler 1200 XC Gold Line	1200	2022 - 2023			490331	520922	
Scrambler 1200 XE Chrome Edition	1200	2022 - 2023			490331	520922	
Scrambler 1200 XE Gold Line	1200	2022 - 2023			490331	520922	
Scrambler Steve McQueen 1200	1200	2020 - 2021			490331	520922	
Scrambler XC, XE 1200	1200	2020 - 2023			490331	520922	
Speed Twin 1200	1200	2021 - 2023			490331	520922	
Speed Twin 1200 Breitling Edition	1200	2022 - 2023			490331	520922	
Thruxton 1200	1200	2016 - 2018	489943		499707	520922	465837
Thruxton 1200 RS	1200	2022 - 2023			490331	520922	
Thruxton R 1200	1200	2016 - 2017	489943		499707	520922	465837
Thruxton TFC R 1200	1200	2019 - 2021	489943		499707	520922	465837
Tiger Explorer 1215	1200	2012 - 2015	489948		499709	520924	
Tiger Explorer XC 1215	1200	2013 - 2021	489948		499709	520924	
Tiger Explorer XCa 1215	1200	2016 - 2021	489948		499709	520924	
Tiger Explorer XCx 1215	1200	2016 - 2021	489948		499709	520924	
Tiger Explorer XR 1215	1200	2016 - 2021	489948		499709	520924	
Tiger Explorer XRt 1215	1200	2016 - 2021	489948		499709	520924	
Tiger Explorer XRx 1215	1200	2016 - 2021	489948		499709	520924	
Trophy 1200	1200	1991 - 1999	490558	512637	499702		465842
Trophy 1200	1200	2000 - 2001	489946		499708	520922	465838
Trophy 1215	1200	2013 - 2016	489948		499709	520924	
Trophy SE 1215	1200	2013 - 2017	489948		499709	520924	
Thunderbird 1600	1600	2009 - 2016	489948		499709	520924	
Thunderbird Commander 1700	1700	2014 - 2017	489948		499709	520924	
Thunderbird LT 1700	1700	2014 - 2017	489948		499709	520924	
Thunderbird Nightstorm 1700	1700	2015 - 2017	489948		499709	520924	
Thunderbird Storm 1700	1700	2011 - 2017	489948		499709	520924	
Rocket III 2300	2300	2004 - 2009	489948		499709	520924	
Rocket III Classic 2300	2300	2006 - 2009	489948		499709	520924	
Rocket III Roadster 2300	2300	2010 - 2019	489948		499709	520924	
Rocket III Touring 2300	2300	2008 - 2019	489948		499709	520924	
Rocket III GT 221 2500	2500	2022 - 2023	500868		513064		
Rocket III GT 2500	2500	2020 - 2021	500868		513064		
Rocket III GT 2500	2500	2022 - 2023	500868		513064		
Rocket III GT Chrome Edition 2500	2500	2022 - 2023	500868		513064		
Rocket III GT R 221 2500	2500	2022 - 2023	500868		513064		
Rocket III GT R Chrome Edition 2500	2500	2022 - 2023	500868		513064		
Rocket III R 2500	2500	2020 - 2023	500868		513064		
VESPA							
946	125	2013 - 2022			493803	520923	
ET4 125	125	1996 - 2005	489940		499706	520922	465836

MOTEUR

CYCLE

PNEUMATIQUE

ATELIER

ACCESSOIRES

ÉLECTRICITÉ

FILTRATION

FREINAGE

TRANSMISSION

Modèle	Cylindre	Année	FULBAT		FULBAT		Lithium	Réf.
			Préconisation constructeur	Sans entretien acide	Sans entretien gel			
Granturismo GT 125	125	2003 - 2006	489938	526367	499700		462573	
Granturismo GT 125	125	2007 - 2009	489943		499707	520922	465837	
GTS 125	125	2013 - 2015	489946		499708	520922	465838	
GTS 125	125	2016 - 2022	489942		499705	520919	465840	
GTS 125	125	2007 - 2012	489943		499707	520922	465837	
GTS 1254V IGET	125	2018 - 2020	489942		499705	520919	465840	
GTS Super 125	125	2023 -	489943		499707	520922	465837	
GTV 125	125	2007 - 2009	489943		499707	520922	465837	
LX 125	125	2005 - 2013	489943		499707	520922	465837	
LXV 125	125	2007 - 2013	489943		499707	520922	465837	
Primavera 125	125	2021 - 2022	489942		499705	520919	465840	
PX 125	125	1998 - 2016	489938	526367	499700		462573	
PX 125E - EFL	125	1981 - 1997	489938	526367	499700		462573	
PX 125T5	125	1985 - 2000	489938	526367	499700		462573	
S 125	125	2007 - 2011	489943		499707	520922	465837	
S 1253V	125	2012 - 2013	489943		499707	520922	465837	
Sport S 1253V	125	2011 - 2013	489943		499707	520922	465837	
Sprint 125	125	2014 - 2022	489942		499705	520919	465840	
Super GTS 125	125	2009 - 2015	489943		499707	520922	465837	
Super GTS 1254V IGET	125	2018 - 2020	489942		499705	520919	465840	
Supersport GTS 125	125	2011 - 2015	489943		499707	520922	465837	
Touring PX 125	125	2015 - 2015	489938	526367	499700		462573	
ET4 150	150	1999 - 2005	489940		499706	520922	465836	
LX 150 (4T)	150	2005 - 2013	489943		499707	520922	465837	
LXV 150	150	2010 - 2012	489943		499707	520922	465837	
PX 150	150	1998 - 2015	489938	526367	499700		462573	
PX 150E - EFL	150	1981 - 1997	489938	526367	499700		462573	
S 150 (4T)	150	2007 - 2013	489943		499707	520922	465837	
Touring PX 150	150	2015 - 2015	489938	526367	499700		462573	
Granturismo GT 200L	200	2003 - 2006	493813		511537		465841	
Granturismo GT 200L	200	2007 - 2009	489946		499708	520922	465838	
PX 200	200	1998 - 2007	489938	526367	499700		462573	
PX 200E EFL	200	1981 - 1997	489938	526367	499700		462573	
GTS 250ie	250	2005 - 2011	489946		499708	520922	465838	
GTV 250ie	250	2007 - 2011	489946		499708	520922	465838	
GTS 300	300	2008 - 2020	489943		499707	520922	465837	
GTS 300	300	2021 - 2022	489943		499707	520922	465837	
GTS 300ie	300	2008 - 2012	489943		499707	520922	465837	
GTS Super 300	300	2023 -	489943		499707	520922	465837	
GTV 300	300	2010 - 2020	489943		499707	520922	465837	
GTV 300	300	2023 -	489943		499707	520922	465837	
Super GTS 300	300	2010 - 2015	489946		499708	520922	465838	
Super Sport GTS 300	300	2011 - 2015	489943		499707	520922	465837	
Touring GTS 300ie	300	2011 - 2015	489943		499707	520922	465837	



Modèle	Cylindre	Année	FULBAT		YUASA		Réf.
			Préconisation constructeur	Sans entretien acide	Sans entretien gel	Lithium	
VICTORY							
Octane 1200	1200	2017 - 2017	512638		511540		
Victory V 92C	1507	1998 - 2003	489948		499709	520924	
Victory V 92SC	1507	2000 - 2003	489948		499709	520924	
King Pin 1633	1633	2004 - 2010	489948		499709	520924	
King Pin Tour 1633	1633	2004 - 2007	489948		499709	520924	
Kingpin 8-Ball 1633	1633	2008 - 2010	489948		499709	520924	
Kingpin Tour 1633	1633	2008 - 2009	489948		499709	520924	
Kingpin-Low 1633	1633	2009 - 2009	489948		499709	520924	
Vegas 1633	1633	2003 - 2012	489948		499709	520924	
Vegas 8-Ball 1633	1633	2005 - 2015	489948		499709	520924	
Vegas Low 1633	1633	2008 - 2009	489948		499709	520924	
Zach Ness Vegas 1633	1633	2008 - 2012	489948		499709	520924	
Arlen Ness Victory Vision 1731	1731	2010 - 2012	489948		499709	520924	
Boardwalk 1731	1731	2013 - 2015	489948		499709	520924	
Cory Ness Cross Country 1731	1731	2011 - 2013	489948		499709	520924	
Cory Ness Jackpot 1731	1731	2008 - 2010	489948		499709	520924	
Cross Country 15th Anniversary 1731	1731	2014 - 2014	489948		499709	520924	
Cross Country 1731	1731	2010 - 2017	489948		499709	520924	
Cross Country 8 Ball 1731	1731	2015 - 2016	489948		499709	520924	
Cross Country Tour 1731	1731	2012 - 2017	489948		499709	520924	
Cross Country Zach Ness 1731	1731	2013 - 2013	489948		499709	520924	
Cross Roads 1731	1731	2010 - 2012	489948		499709	520924	
Cross Roads 8 Ball 1731	1731	2014 - 2014	489948		499709	520924	
Cross Roads Classic 1731	1731	2013 - 2014	489948		499709	520924	
Gunner 1731	1731	2015 - 2017	489948		499709	520924	
Hammer 1731	1731	2005 - 2011	489948		499709	520924	
Hammer 8 Ball 1731	1731	2010 - 2016	489948		499709	520924	
Hammer S 1731S	1731	2007 - 2017	489948		499709	520924	
Hard Ball 1731	1731	2012 - 2013	489948		499709	520924	
High Ball 1731	1731	2011 - 2017	489948		499709	520924	
Jackpot 1731	1731	2010 - 2016	489948		499709	520924	
Judge 1731	1731	2012 - 2017	489948		499709	520924	
King Pin 1731	1731	2011 - 2012	489948		499709	520924	
Kingpin 8-Ball 1731	1731	2011 - 2011	489948		499709	520924	
Magnum 1731	1731	2015 - 2017	489948		499709	520924	
Ness Signature Series 1731	1731	2005 - 2007	489948		499709	520924	
Vegas 1731	1731	2008 - 2017	489948		499709	520924	
Vegas 8 Ball 1731	1731	2008 - 2017	489948		499709	520924	
Vegas High Ball 1731	1731	2012 - 2012	489948		499709	520924	
Vegas Jackpot 1731	1731	2006 - 2007	489948		499709	520924	
Vision 10th Anniversary Edition 1731	1731	2009 - 2009	489948		499709	520924	
Vision 1731	1731	2014 - 2014	489948		499709	520924	
Vision 8 Ball 1731	1731	2010 - 2011	489948		499709	520924	
Vision Arlen Ness 1731	1731	2009 - 2013	489948		499709	520924	

MOTEUR

CYCLE

PNEUMATIQUE

ATELIER

ACCESSOIRES

ÉLECTRICITÉ

FILTRATION

FREINAGE

TRANSMISSION

Modèle	Cylindre	Année	FULBAT	FULBAT	YUASA		Réf.
			Préconisation constructeur	Sans entretien acide	Sans entretien gel	Lithium	
Vision Street 1731	1731	2008 - 2009	489948		499709	520924	
Vision Street Premium 1731	1731	2009 - 2009	489948		499709	520924	
Vision Tour 1731	1731	2008 - 2017	489948		499709	520924	
VOXAN							
Black Magic 1000	1000	2006 - 2008	489948		499709	520924	
Cafe Racer 1000	1000	2002 - 2008	489948		499709	520924	
Charade Racing 1000	1000	2005 - 2008	489948		499709	520924	
Cyclope 1000	1000	2002 - 2002	489948		499709	520924	
Roadster 1000	1000	1999 - 2008	489948		499709	520924	
Scrambler 1000	1000	2003 - 2006	489948		499709	520924	
Street Scrambler 1000	1000	2004 - 2008	489948		499709	520924	
VBI-Evo 1000	1000	2003 - 2004	489948		499709	520924	
GTV 1200	1200	2008 - 2008	489948		499709	520924	
YAMAHA							
Beluga XC 125	125	1992 - 1995	500961		513058		
BW's YW 125	125	2010 - 2014			491434	520921	
BW's YW 125X	125	2010 - 2013			491434	520921	
Custom YBR 125SPD	125	2008 - 2016	489942		499705	520919	465840
Cygnus X XC 125	125	2004 - 2006	489941		499704	520922	465834
Cygnus XC 125T	125	1996 - 1996	500961		513058		
Cygnus XC 125TR	125	1996 - 2003	500961		513058		
Cygnus Xi XC 125	125	2007 - 2013	491434			520921	488128 510616
D'Elight LT-S 125C	125	2017 - 2020	499703			520919	510612
D'Elight LT-S 125C	125	2021 - 2023	517317			520919	
Dragstar XVS 125	125	2000 - 2005	493802			520919	483662
DT 125E	125	1974 - 1979					
DT 125LC	125	1981 - 1984			517777		
DT 125LC	125	1985 - 1988	490557		511532		467892
DT 125MX	125	1978 - 1991			517777		
DT 125R	125	1988 - 2003	490557		511532		467892
DT 125RE	125	2004 - 2007	493802			520919	483662
DT 125X	125	2005 - 2006	493802			520919	483662
Flame X XC 125	125	2007 - 2008			491434	520921	
Flame X XC 125	125	2005 - 2006	489941		499704	520922	465834
Lightburner TDR 125R	125	1993 - 1994	489944		499703	520919	465835
Majesty XC 125R	125	2014 - 2014	491434			520921	488128 510616
Majesty YP 125	125	1998 - 2009			511535	520919	
Majesty YP 125FA	125	2002 - 2002			511535	520919	
Maxster XQ 125N	125	2001 - 2003	490559		511535	520919	462572
MT 125	125	2015 - 2016	493811		513056		
MT 125A	125	2015 - 2020	493811		513056		
MT 125A	125	2020 - 2023	489937		489939	520919	465833
N-Max 125 GPD 125-A	125	2015 - 2021	493802			520919	483662



Modèle	Cylindre	Année	FULBAT		YUASA		
			Préconisation constructeur	Sans entretien acide	Sans entretien gel	Lithium	Réf.
N-Max 125 GPD 125-A	125	2022	517317			520919	
Raptor YFM 125R	125	2011 - 2013	493802			520919	483662
RD 125LC	125	1986 - 1989	489935		511534	520919	462568
RD 125T	125	1975 - 1975	493810		513055		
Skycruiser Sport YP 125R	125	2012 - 2012	489940		499706	520922	465836
Skyliner S XC 125R	125	2014 - 2014	491434			520921	488128 510616
SR 125	125	1989 - 1997					
SR 125	125	1998 - 2003			511535	520919	
SR 125SE	125	1993 - 1996					
Supermoto WR 125X	125	2009 - 2016	493811		513056		
TDR 125	125	1989 - 1993	489944		499703	520919	465835
TDR 125R	125	1994 - 2003	489944		499703	520919	465835
Teo's XN 125N	125	2000 - 2003	490559		511535	520919	462572
Tricity 125 MWS 125-C	125	2022	517317			520919	
Tricity MW 125	125	2014 - 2016	493802			520919	483662
Tricity MW 125A	125	2015 - 2016	493802			520919	483662
Tricity MWS 125A	125	2017 - 2020	493802			520919	483662
Tricity MWS 125C	125	2017 - 2018	493802			520919	483662
TT-R 125	125	2000 - 2005	489937		489939	520919	465833
TT-R 125E	125	2004 - 2009	489937		489939	520919	465833
TT-R 125LW	125	2000 - 2016	489937		489939	520919	465833
TT-R 125LWE	125	2003 - 2017	489937		489939	520919	465833
TW 125	125	1999 - 2001	500961		513058		
TW 125	125	2002 - 2006	493802			520919	483662
TZR 125	125	1987 - 1995	489935		511534	520919	462568
TZR 125R	125	1991 - 1993	489935		511534	520919	462568
TZR 125RR	125	1994 - 1997	489935		511534	520919	462568
Virago XV 125	125	1997 - 2001	500870		511537		
Vity XC 125E	125	2008 - 2013	489941		499704	520922	465834
WR 125R	125	2009 - 2016	493811		513056		
X-City VP 125	125	2008 - 2015	489940		499706	520922	465836
Xenter HW 125	125	2012 - 2017	491434			520921	488128 510616
X-Max - Iron Max YP 125RA	125	2016 - 2016	490564			520921	510618 512773
X-Max 125 YP 125RA	125	2021 - 2023	517317			520919	
X-Max Business YP 125RA	125	2011 - 2011	489940		499706	520922	465836
X-Max Sport YP 125R	125	2014 - 2016	490564			520921	510618 512773
X-Max Sport YP 125R	125	2011 - 2013	489940		499706	520922	465836
X-Max YP 125	125	2014 - 2017	490564			520921	510618 512773
X-Max YP 125R	125	2014 - 2015	490564			520921	510618 512773
X-Max YP 125R	125	2006 - 2013	489940		499706	520922	465836

MOTEUR

CYCLE

PNEUMATIQUE

ATELIER

ACCESSOIRES

ÉLECTRICITÉ

FILTRATION

FREINAGE

TRANSMISSION

Modèle	Cylindre	Année	FULBAT	FULBAT	Lithium	Réf.
			Préconisation constructeur	Sans entretien acide		
X-Max YP 125RA	125	2014 - 2016	490564		520921	510618 512773
X-Max YP 125RA	125	2011 - 2013	489940		499706	520922
X-Max YP 125RA	125	2017 - 2020	500281			520919
XSR 125	125	2021 - 2023	489937		489939	520919
XT 125R	125	2005 - 2011	489942		499705	520919
XT 125X	125	2005 - 2011	489942		499705	520919
XTZ 125	125	2003 - 2010	489935		511534	520919
YB 125SPD	125	2008 - 2008	489942		499705	520919
YBR 125	125	2000 - 2006	489935		511534	520919
YBR 125	125	2007 - 2008	489942		499705	520919
YBR 125E	125	2006 - 2013	489935		511534	520919
YBR 125ED	125	2005 - 2006	489935		511534	520919
YBR 125ED	125	2007 - 2014	489942		499705	520919
YBR 125EGS	125	2008 - 2016	489935		511534	520919
YS 125	125	2017 - 2021	489944		499703	520919
YZF-R 125	125	2008 - 2013	493810		513055	
YZF-R 125	125	2014 - 2016	493811		513056	
YZF-R 125A	125	2015 - 2018	493811		513056	
YZF-R 125A	125	2019 - 2023	489939			520919
Crypton XT 135S	135	2006 - 2008	489939			520919
Crypton XT 135SE	135	2006 - 2008	489939			520919
Maxster XQ 150N	150	2001 - 2003	490559		511535	520919
N-Max GPD 150A	150	2015 - 2017	493802			520919
Xenter HW 151	150	2012 - 2016	491434			520921
Tricity MWS 155	155	2018 - 2020	493802			520919
DT 175	175	1977 - 1996			517777	
Blaster YFS 200	200	1989 - 2006	489946		499708	520922
DT 200R	200	1988 - 1995	490557		511532	
DT 200WR	200	1992 - 1993	490557		511532	
IT 200L	200	1985 - 1986	490557		511532	
RD 200DX	200	1975 - 1980	489938	526367	499700	
SDR 200	200	1987 - 1989	490557		511532	
TW 200	200	1989 - 1994	500961		513058	
YFM 200D	200	1989 - 1990	489946		499708	520922
YFM 200N	200	1985 - 1985	489946		499708	520922
YTM 200ELD	200	1989 - 1989	489946		499708	520922
Serrow XT 225	225	1986 - 1993	489942		499705	520919
Serrow XT 225W	225	1993 - 1998	489942		499705	520919
TW 225E	225	2003 - 2003	500961		513058	
XT 225	225	1997 - 2000	489942		499705	520919
XT 225	225	2001 - 2006	493802			520919
YFM 225	225	1986 - 1989	489946		499708	520922
YTM 225DR	225	1985 - 1985	489946		499708	520922



Modèle	Cylindre	Année	FULBAT		YUASA		
			Préconisation constructeur	Sans entretien acide	Sans entretien gel	Lithium	Réf.
TTR 230	230	2005 - 2006	489944		499703	520919	465835
Bear Tracker YFM 250X	250	1999 - 2004	501411		513059		
Big Bear YFM 250B	250	2007 - 2010	501411		513059		
Bruin YFM 250B	250	2005 - 2006	501411		513059		
Classic SR 250	250	1996 - 2000	524567		511538		
Custom SR 250	250	1980 - 1981	524567		511538		
Dragster XVS 250	250	2001 - 2003	493802			520919	483662
DT 250	250	1977 - 1980			517777		
DT 250MX	250	1980 - 1982			517777		
Fazer YS 250	250	2006 - 2008	489942		499705	520919	465840
Lander XTZ 250	250	2007 - 2009	489942		499705	520919	465840
Majesty YP 250	250	1996 - 2003	491434			520921	488128 510616
Majesty YP 250DX	250	1998 - 1999	491434			520921	488128 510616
Maxam CP 250	250	2005 - 2008	490331			520922	483849
Raptor YFM 250R	250	2008 - 2013	493802			520919	483662
RD 250LC	250	1980 - 1986	493810		513055		
Serow XT 250	250	2005 - 2005	489942		499705	520919	465840
Soufultwin Renaissa SRV 250	250	1992 - 1997	489941		499704	520922	465834
SR 250	250	1991 - 1995	524567		511538		
SR 250SE	250	1981 - 1984	524567		511538		
SRX 250	250	1987 - 1987	524567		511538		
Supermoto WR 250X	250	2008 - 2015	493802			520919	483662
TDR 250	250	1988 - 1992	489935		511534	520919	462568
Tricker XG 250	250	2004 - 2007	493802			520919	483662
TRX 250X	250	2012 - 2013	489940		499706	520922	465836
TT 250R	250	1993 - 2004	491434			520921	488128 510616
TZR 250	250	1987 - 1992	489935		511534	520919	462568
TZR 250R	250	1991 - 1993	489935		511534	520919	462568
TZR 250RS	250	1992 - 1994	489935		511534	520919	462568
TZR 250SP	250	1990 - 1990	489935		511534	520919	462568
TZR 250SPR	250	1995 - 1995	489935		511534	520919	462568
USA TT 250R	250	1999 - 2006	491434			520921	488128 510616
Virago XV 250	250	1989 - 1994	500870		511537		
Virago XV 250S	250	1995 - 2000	500870		511537		
WR 250F	250	2003 - 2007	489944		499703	520919	465835
WR 250F	250	2008 - 2023	493802			520919	483662
WR 250R	250	2008 - 2016	493802			520919	483662
X-City VP 250	250	2007 - 2016	489940		499706	520922	465836
X-Max - Iron Max YP 250RA	250	2016 - 2016	490564			520921	510618 512773
X-Max Sport YP 250R	250	2011 - 2012	489940		499706	520922	465836

MOTEUR

CYCLE

PNEUMATIQUE

ATELIER

ACCESSOIRES

ÉLECTRICITÉ

FILTRATION

FREINAGE

TRANSMISSION

Modèle	Cylindre	Année	FULBAT	FULBAT	Lithium	Réf.	
			Préconisation constructeur	Sans entretien acide			Sans entretien gel
X-Max YP 250R	250	2014 - 2016	490564		520921	510618 512773	
X-Max YP 250R	250	2005 - 2013	489940		499706	520922	465836
X-Max YP 250RA	250	2014 - 2015	490564			520921	510618 512773
X-Max YP 250RA	250	2011 - 2013	489940		499706	520922	465836
XS 250	250	1979 - 1981	524567		511538		
XS 250C	250	1978 - 1981	524567		511538		
XS 250S	250	1979 - 1982	524567		511538		
XT 250	250	1980 - 1983			517777		
XT 250X	250	2006 - 2008	493802			520919	483662
YBR 250	250	2007 - 2012	489942		499705	520919	465840
YFM 250	250	1990 - 1991	489946		499708	520922	465838
Grizzly YFM 300	300	2012 - 2013	489943		499707	520922	465837
MT-03 320A MTN 320	300	2016 - 2023	500281			520919	506883
Tricity 300 MWD300	300	2021 - 2023	500281			520919	506883
Versity VP 300	300	2003 - 2005	489940		499706	520922	465836
Versity XC 300	300	2006 - 2006	489940		499706	520922	465836
X-Max CZD 300A	300	2017 - 2023	500281			520919	506883
YZF-R3 320	300	2015 - 2023	500281			520919	506883
Big Bear YFM 350FW	350	1987 - 1998	501411		513059		
Bruin YFM 350AN	350	2004 - 2006	512638		511540		
Bruin YFM 350FA	350	2004 - 2006	512638		511540		
BW 350E BW 350E	350	1986 - 1988	493812		513057		462571
Grizzly YFM 350A	350	2016 - 2018	512638		511540		
Grizzly YFM 350D	350	2014 - 2014	512638		511540		
Grizzly YFM 350FG - FWA	350	2007 - 2018	512638		511540		
Grizzly YFM 350G	350	2007 - 2010	512638		511540		
Grizzly YFM 350GGI	350	2007 - 2010	512638		511540		
Grizzly YFM 350T	350	2014 - 2014	512638		511540		
Raptor YFM 350	350	2004 - 2004	490331			520922	483849
Raptor YFM 350R	350	2005 - 2013	490331			520922	483849
RD 350LC	350	1980 - 1982	493810		513055		
RD 350LCF	350	1985 - 1992	489935		511534	520919	462568
RD 350N	350	1985 - 1985	489935		511534	520919	462568
RD 350R	350	1992 - 1995	489935		511534	520919	462568
RD 350YPVS	350	1983 - 1984	493810		513055		
Wolverine YFM 350X	350	2006 - 2009	512638		511540		
XT 350	350	1985 - 1998	490557		511532		467892
YFM 350ER	350	1992 - 1995	512638		511540		
YFM 350U	350	1996 - 1998	524569	512638	511540		
XS 360	360	1975 - 1977	524567		511538		
Big Bear YFM 400FP	400	2003 - 2004	489948		499709	520924	
Big Bear YFM 400FW	400	2002 - 2002	489948		499709	520924	
DT 400	400	1977 - 1977			517777		



Modèle	Cylindre	Année	FULBAT		YUASA		
			Préconisation constructeur	Sans entretien acide	Sans entretien gel	Lithium	Réf.
DT 400MX	400	1977 - 1978			517777		
FZR 400	400	1988 - 1988	491025		499701		462574
FZR 400R	400	1989 - 1989	491025		499701		462574
FZR 400RR	400	1986 - 1986	491025		499701		462574
FZR 400RR	400	1990 - 1995	489940		499706	520922	465836
FZR 400RRS	400	1986 - 1986	491025		499701		462574
FZR 400RS	400	1986 - 1986	491025		499701		462574
Genesis FZR 400	400	1986 - 1986	491025		499701		462574
Grizzly YFM 400FG	400	2007 - 2008	489946		499708	520922	465838
Kodiak YFM 400A	400	2003 - 2003	512638		511540		
Kodiak YFM 400FA	400	2003 - 2006	512638		511540		
Kodiak YFM 400FA	400	2000 - 2001	489948		499709	520924	
Kodiak YFM 400FW	400	1993 - 1995	501411		513059		
Kodiak YFM 400FW	400	1996 - 1999	489948		499709	520924	
Majesty YP 400	400	2004 - 2014	490564			520921	510618 512773
SR 400	400	1978 - 2016	494764		513061		
T-Max - Iron Max XP 400RA	400	2016 - 2016	490564			520921	510618 512773
XJR 400	400	1993 - 1999	489940		499706	520922	465836
X-Max YP 400R	400	2013 - 2016	490564			520921	510618 512773
X-Max YP 400RA	400	2013 - 2017	490564			520921	510618 512773
X-Max YP 400RA	400	2018 - 2020	500281			520919	506883
XS 400	400	1979 - 1979	524567		511538		
XS 400C	400	1978 - 1980	524567		511538		
XS 400DOHC	400	1982 - 1986	524567		511538		
XS 400SE	400	1980 - 1981	524567		511538		
Grizzly YFM 450D	450	2014 - 2015	489948		499709	520924	
Grizzly YFM 450FG	450	2007 - 2013	489948		499709	520924	
Grizzly YFM 450FGI	450	2010 - 2012	489948		499709	520924	
Grizzly YFM 450FGP	450	2011 - 2013	489948		499709	520924	
Grizzly YFM 450FWA	450	2012 - 2017	489948		499709	520924	
Grizzly YFM 450FWA D	450	2016 - 2017	489948		499709	520924	
Grizzly YFM 450P	450	2014 - 2014	489948		499709	520924	
Kodiak YFM 450FA	450	2003 - 2006	489948		499709	520924	
Kodiak YFM 450FWB	450	2018 - 2021	489948		499709	520924	
Kodiak YFM 450FWB D	450	2018 - 2021	489948		499709	520924	
Wolverine YFM 450FX	450	2006 - 2007	489948		499709	520924	
Wolverine YFM 450FX	450	2008 - 2010	489948		499709	520924	
WR 450F	450	2003 - 2022	493802			520919	483662
YFZ 450	450	2003 - 2013	491434			520921	488128 510616
YFZ 450R	450	2009 - 2021	493802			520919	483662
YZ 450FX	450	2016 - 2020	493802			520919	483662

MOTEUR

CYCLE

PNEUMATIQUE

ATELIER

ACCESSOIRES

ÉLECTRICITÉ

FILTRATION

FREINAGE

TRANSMISSION

Modèle	Cylindre	Année	FULBAT		YUASA		Réf.
			Préconisation constructeur	Sans entretien acide	Sans entretien gel	Lithium	
FZR 500	500	1989 - 1993	491025		499701		462574
RD 500LC	500	1984 - 1987	493810		513055		
SR 500	500	1978 - 1995					
SR 500	500	1996 - 2000	494764		513061		
SR 500S	500	1998 - 1998	494764		513061		
T-Max XP 500	500	2001 - 2007	490564			520921	510618 512773
T-Max XP 500	500	2008 - 2012	490331			520922	483849
T-Max XP 500A	500	2008 - 2012	490331			520922	483849
XS 500	500	1975 - 1979	490558	512637	499702		465842
XT 500	500	1976 - 1985			517777		
XT 500	500	1986 - 1989	490557		511532		467892
XT 500E	500	1990 - 1996	489935		511534	520919	462568
XT 500T	500	1988 - 1989	489935		511534	520919	462568
XT 500Z	500	1988 - 1989	489935		511534	520919	462568
Black Max XP 530A	530	2013 - 2014	490330			520922	490511
Iron Max XP 530	530	2015 - 2015	490330			520922	490511
Iron Max XP 530A	530	2015 - 2016	490330			520922	490511
T-Max - Lux Max XP 530A	530	2016 - 2016	490330			520922	490511
T-Max XP 530	530	2012 - 2016	490330			520922	490511
T-Max XP 530A	530	2012 - 2019	490330			520922	490511
T-Max XP 530D-A	530	2017 - 2019	490330			520922	490511
T-Max XP 530E-A	530	2017 - 2018	490330			520922	490511
Virago XV 535	535	1988 - 2003	491025		499701		462574
Virago XV 535S	535	1995 - 2003	491025		499701		462574
Grizzly YFM 550D	550	2013 - 2013	489948		499709	520924	
Grizzly YFM 550FG	550	2009 - 2013	489948		499709	520924	
Grizzly YFM 550FWA	550	2009 - 2016	489948		499709	520924	
Maxim XJ 550	550	1981 - 1983	524567		511538		
Seca XJ 550R	550	1981 - 1983	524567		511538		
XJ 550	550	1981 - 1984	524567		511538		
XT 550	550	1982 - 1983	489935		511534	520919	462568
XZ 550	550	1982 - 1984	490558	512637	499702		465842
T-Max XP 560E-A	560	2020 - 2023	490330			520922	490511
Diversion XJ 600N	600	1991 - 2003	489940		499706	520922	465836
Diversion XJ 600S	600	1992 - 2003	489940		499706	520922	465836
Diversion XJ 6F	600	2010 - 2016	493803			520923	510622
Diversion XJ 6FA	600	2010 - 2016	493803			520923	510622
Diversion XJ 6N	600	2009 - 2016	493803			520923	510622
Diversion XJ 6NA	600	2009 - 2016	493803			520923	510622
Diversion XJ 6S	600	2009 - 2016	493803			520923	510622
Diversion XJ 6SA	600	2009 - 2016	493803			520923	510622
Diversion XJ 6SP	600	2013 - 2013	493803			520923	510622
Fazer FZ 6S	600	2004 - 2007	493803			520923	510622
Fazer FZ 6S2	600	2007 - 2009	493803			520923	510622



Modèle	Cylindre	Année	FULBAT		YUASA		
			Préconisation constructeur	Sans entretien acide	Sans entretien gel	Lithium	Réf.
Fazer FZS 600	600	1998 - 2003	493803			520923	510622
FZ 600	600	1986 - 1988	524567		511538		
FZ 6N	600	2004 - 2007	493803			520923	510622
FZ 6S2	600	2007 - 2010	493803			520923	510622
FZR 600	600	1989 - 1993	491025		499701		462574
FZR 600R	600	1994 - 1995	489943		499707	520922	465837
Grizzly hunting YFM 600FH	600	2000 - 2000	489948		499709	520924	
Grizzly YFM 600F	600	2000 - 2001	489948		499709	520924	
Grizzly YFM 600FWA	600	1998 - 1999	489948		499709	520924	
Radian XJ 600	600	1984 - 1991	524567		511538		
Radian YX 600	600	1986 - 1990	524567		511538		
SRX 600	600	1985 - 1993	489935		511534	520919	462568
Tenere XT 600Z	600	1983 - 1984	524568		511538		
Tenere XT 600Z	600	1986 - 1995	491025		499701		462574
Tenere XT 600Z	600	1985 - 1985	489935		511534	520919	462568
Thunder cat YZF 600R	600	1996 - 2003	489943		499707	520922	465837
TT 600E	600	1994 - 2001	489940		499706	520922	465836
TT 600K	600	1993 - 1996	489940		499706	520922	465836
TT 600RE	600	2002 - 2004	490564			520921	510618 512773
XT 600	600	1984 - 1995	489935		511534	520919	462568
XT 600E	600	1990 - 2003	489940		499706	520922	465836
YZF 600R6	600	1999 - 2000	493803			520923	510622
YZF 600R6	600	2001 - 2005	490564			520921	510618 512773
YZF 600R6	600	2006 - 2016	490331			520922	483849
YZF 600R6	600	2017 - 2020	493802			520919	483662
YZF 600R6 Race YZF 600R6	600	2021 - 2023	493802			520919	483662
Drag Star CLassic XVS 650A	650	1998 - 2007	493803			520923	510622
Drag Star XVS 650	650	1997 - 2004	493803			520923	510622
Turbo XJ 650	650	1982 - 1982	524567		511538		
XJ 650	650	1980 - 1984	524567		511538		
XJ 650L	650	1981 - 1983	524567		511538		
XJ 650R	650	1982 - 1982	524567		511538		
XS 650	650	1975 - 1981	490558	512637	499702		465842
XS 650SE	650	1979 - 1981	490558	512637	499702		465842
Grizzly YFM 660F	660	2002 - 2004	489948		499709	520924	
Grizzly YFM 660FA	660	2005 - 2006	489948		499709	520924	
Grizzly YFM 660FG	660	2007 - 2008	489948		499709	520924	
Grizzly YFM 660FWA	660	2002 - 2008	489948		499709	520924	
MT-03 660	660	2006 - 2013	490564			520921	510618 512773
Raptor YFM 660R	660	2001 - 2006	489946		499708	520922	465838
Supermoto XT 660X	660	2004 - 2016	490564			520921	510618 512773

MOTEUR

CYCLE

PNEUMATIQUE

ATELIER

ACCESSOIRES

ÉLECTRICITÉ

FILTRATION

FREINAGE

TRANSMISSION

Modèle	Cylindre	Année	FULBAT	FULBAT	Lithium	Réf.
			Préconisation constructeur	Sans entretien acide		
SZR 660	660	1996 - 1998	490564		520921	510618 512773
Tenere XT 660Z	660	2008 - 2016	490564		520921	510618 512773
Tenere XT 660ZA	660	2011 - 2016	490564		520921	510618 512773
Tenere XTZ 660	660	1990 - 2000	489940		499706	520922
XT 660R	660	2004 - 2016	490564			520921
Fazer FZX 700	700	1986 - 1987	490558	512637	499702	465842
Grizzly YFM 700D	700	2014 - 2014	489948		499709	520924
Grizzly YFM 700F WAD	700	2016 - 2016	489948		499709	520924
Grizzly YFM 700FGP	700	2007 - 2013	489948		499709	520924
Grizzly YFM 700FWA	700	2016 - 2017	489948		499709	520924
Grizzly YFM 700FWAD	700	2017 - 2021	489948		499709	520924
Grizzly YFM 700P	700	2014 - 2014	489948		499709	520924
Kodiak YFM 700FWB	700	2016 - 2021	489948		499709	520924
Kodiak YFM 700FWBD	700	2016 - 2021	489948		499709	520924
MT-07 690	700	2021 - 2023	490331			520922
MT-07 690-U MT-07 690U	700	2021 - 2023	490331			520922
MT-07 700	700	2014 - 2016	490331			520922
MT-07 700A	700	2014 - 2017	490331			520922
MT-07 700A-U	700	2018 - 2020	490331			520922
MT-07 MTN690	700	2021 - 2023	490331			520922
MT-07 MTN690-U A2 35KW	700	2021 - 2023	490331			520922
MTT Tracer MT-07 700AB	700	2017 - 2017	490331			520922
MTT Tracer MT-07 700A-U	700	2016 - 2020	490331			520922
MTT-690 Tracer 7 Tracer 7	700	2020 - 2021	493802			520919
MTT690-U Tracer 7 A2 35KW Tracer 7	700	2020 - 2021	493802			520919
Raptor YFM 700R	700	2005 - 2021	490564			520921
Tenere 700 Rally Edition XT 700ZD-B	700	2021 - 2023	490331			520922
Tenere 700 World Raid XTZ700D	700	2022	490331			520922
Tenere 700 XTZ700	700	2019 - 2023	490331			520922
Tracer 7 A2 35KW MTT690	700	2021 - 2023	493802			520919
Tracer 7 MTT690	700	2021 - 2023	493802			520919
Tracer 700 A2 35KW MTT690-U	700	2020	493802			520919
Tracer 700 MTT690-A	700	2020	493802			520919
XSR 700 MTM 690	700	2016 - 2023	490331			520922
XSR 700 MTM 690 U A2 35KW	700	2016 - 2023	490331			520922
XSR 700 XTribute MTM 690D	700	2019 - 2023	490331			520922
XSR 700 XTribute MTM 690-U A2 35KW	700	2019 - 2023	490331			520922
YZF-R7 690	700	2021 - 2023	493802			520919
YZF-R7 690-U A2 35KW	700	2021 - 2023	493802			520919
Fazer FZX 750	750	1986 - 1997	490558	512637	499702	465842
FZ 750	750	1985 - 1991	490558	512637	499702	465842



Modèle	Cylindre	Année	FULBAT		FULBAT		YUASA
			Préconisation constructeur	Sans entretien acide	Sans entretien gel	Lithium	Réf.
Genesis FZR 750	750	1987 - 1989	490558	512637	499702		465842
OW01 FZR 750R	750	1988 - 1990	490558	512637	499702		465842
OW02 YZF 750R7	750	1999 - 2003	490564			520921	510618 512773
Seca XJ 750R	750	1981 - 1983	490558	512637	499702		465842
Super Tenere XTZ 750	750	1989 - 2000	490558	512637	499702		465842
Virago XV 750	750	1992 - 1997			511541		
XJ 750	750	1982 - 1984	490558	512637	499702		465842
XS 750	750	1977 - 1979	490558	512637	499702		465842
XS 750SE	750	1979 - 1980	490558	512637	499702		465842
XV 750SE	750	1981 - 1981			511541		
YZF 750R	750	1993 - 1998	489943		499707	520922	465837
YZF 750SP	750	1993 - 1999	489943		499707	520922	465837
Fazer FZ 8S	800	2010 - 2016	490331			520922	483849
Fazer FZ 8SA	800	2010 - 2016	490331			520922	483849
FZ 8N	800	2010 - 2016	490331			520922	483849
FZ 8NA	800	2010 - 2016	490331			520922	483849
TDM 850	850	1996 - 2001	493803			520923	510622
TDM 850	850	1991 - 1995	489943		499707	520922	465837
TRX 850	850	1996 - 1999	489943		499707	520922	465837
XS 850	850	1980 - 1980	490558	512637	499702		465842
Diversion XJ 900S	900	1995 - 2003	489946		499708	520922	465838
MT-09 850	900	2013 - 2016	490331			520922	483849
MT-09 850A	900	2014 - 2020	490331			520922	483849
MT-09 A2 35KW MTN 890-U	900	2022 - 2023	490331			520922	483849
MT-09 MTN 890	900	2021 - 2023	490331			520922	483849
MT-09 SP A2 35KW MTN 890-U	900	2022 - 2023	490331			520922	483849
MT-09 SP MTN 890D	900	2021 - 2023	490331			520922	483849
Niken MXT 850	900	2019 - 2023	490331			520922	483849
SP MT-09 850A	900	2018 - 2020	490331			520922	483849
Sport Tracker MT-09 850A	900	2014 - 2017	490331			520922	483849
Street Rally MT-09 850A	900	2014 - 2017	490331			520922	483849
TDM 900	900	2002 - 2014	493803			520923	510622
TDM 900A	900	2005 - 2013	493803			520923	510622
Tracer 9 GT MTT 890D	900	2021 - 2023	490331			520922	483849
Tracer 9 MTT 890	900	2021 - 2023	490331			520922	483849
Tracer GT MT-09 850A	900	2018 - 2020	490331			520922	483849
Tracer MT-09 850A	900	2015 - 2020	490331			520922	483849
XJ 900	900	1983 - 1994	490558	512637	499702		465842
XJ 900F	900	1983 - 1994	490558	512637	499702		465842
XSR 900	900	2017 - 2023	490331			520922	483849
XSR 900 Abarth	900	2017 - 2018	490331			520922	483849
XSR 900 MTM 850	900	2016 - 2018	490331			520922	483849
Bolt C-Spec XVS 950CR	950	2015 - 2016	490556			520922	490512
Midnight Star XVS 950A	950	2009 - 2013	490556			520922	490512

MOTEUR

CYCLE

PNEUMATIQUE

ATELIER

ACCESSOIRES

ÉLECTRICITÉ

FILTRATION

FREINAGE

TRANSMISSION

Modèle	Cylindre	Année	FULBAT		FULBAT		Lithium	Réf.
			Préconisation constructeur	Sans entretien acide	Sans entretien gel			
Racer XV 950	950	2017 - 2018	490556			520922	490512	
SCR950 XVS 950XR	950	2017 - 2020	490556			520922	490512	
XV 950	950	2017 - 2017	490556			520922	490512	
XV 950R	950	2014 - 2020	490556			520922	490512	
XVS 950CU	950	2014 - 2016	490556			520922	490512	
Fazer FZ 1NA	1000	2008 - 2015	490556			520922	490512	
Fazer FZ 1S	1000	2006 - 2015	490556			520922	490512	
Fazer FZ 1SA	1000	2008 - 2015	490556			520922	490512	
Fazer FZS 1000	1000	2001 - 2006	493804			520923		
FZ 1N	1000	2006 - 2015	490556			520922	490512	
FZR 1000EXUP	1000	1989 - 1990	490558	512637	499702		465842	
FZR 1000EXUP	1000	1991 - 1997	489946		499708	520922	465838	
Genesis FZR 1000	1000	1987 - 1988	490558	512637	499702		465842	
GTS 1000	1000	1993 - 1999	489946		499708	520922	465838	
MT-10 1000	1000	2016 - 2023	490331			520922	483849	
MT-10 1000SP	1000	2017 - 2023	490331			520922	483849	
Thunderace YZF 1000R	1000	1996 - 2001	489946		499708	520922	465838	
Tourer Edition MT-10 1000	1000	2018 - 2020	493802			520919	483662	
Virago XV 1000	1000	1986 - 1986		504082	511545	520924		
Virago XV 1000SE	1000	1988 - 1988		504082	511545	520924		
XV 1000TRI	1000	1981 - 1981		504082	511545	520924		
YZF 1000R1	1000	1998 - 2003	493803			520923	510622	
YZF 1000R1	1000	2004 - 2014	490331			520922	483849	
YZF 1000R1 SP	1000	2006 - 2006	490331			520922	483849	
YZF-R1 1000	1000	2015 - 2023	493802			520919	483662	
YZF-R1 1000M	1000	2015 - 2023	493802			520919	483662	
YZF-R1 S 1000	1000	2016 - 2016	493802			520919	483662	
Bulldog BT 1100	1100	2002 - 2006	493804			520923		
Drag Star Classic XVS 1100A	1100	2000 - 2006	493804			520923		
Drag Star XVS 1100	1100	1999 - 2004	493804			520923		
FJ 1100	1100	1984 - 1985	490558	512637	499702		465842	
Virago XV 1100	1100	1989 - 1999		504082	511545	520924		
XS 1100	1100	1978 - 1980		504082	511545	520924		
XS 1100S	1100	1981 - 1981		504082	511545	520924		
FJ 1200	1200	1986 - 1989	490558	512637	499702		465842	
FJ 1200	1200	1990 - 1995	489946		499708	520922	465838	
FJ 1200A	1200	1991 - 1995	489946		499708	520922	465838	
Super Tenere XT 1200Z	1200	2010 - 2020	490330			520922	490511	
Super Tenere XT 1200ZE	1200	2014 - 2020	490330			520922	490511	
V-Max VMX 12	1200	1991 - 2003			511541			
XJR 1200	1200	1995 - 1998	489946		499708	520922	465838	
XVZ 12T	1200	1985 - 1985		504082	511545	520924		
FJR 1300	1300	2001 - 2005	493804			520923		
FJR 1300A	1300	2003 - 2020	493804			520923		
FJR 1300AE	1300	2015 - 2020	493804			520923		



Modèle	Cylindre	Année	FULBAT		FULBAT		YUASA
			Préconisation constructeur	Sans entretien acide	Sans entretien gel	Lithium	Réf.
FJR 1300AS	1300	2006 - 2020	493804			520923	
Midnight Star XVS 1300A	1300	2007 - 2016	489948		499709	520924	
Midnight Star XVS 1300CU	1300	2014 - 2016	489948		499709	520924	
Racer XJR 1300C	1300	2016 - 2017	490556			520922	490512
Royal Star XVZ 1300	1300	1996 - 2001	489948		499709	520924	
Venture Star XVZ 1300TF	1300	1999 - 2001	489948		499709	520924	
XJR 1300	1300	1998 - 2006	493804			520923	
XJR 1300	1300	2007 - 2014	490556			520922	490512
XJR 1300C	1300	2015 - 2017	490556			520922	490512
XJR 1300SP	1300	1999 - 2001	493804			520923	
Wildstar XV 1600A	1600	1999 - 2004	489948		499709	520924	
MT-01 1670	1670	2005 - 2012	493804			520923	
MT-01 1670S	1670	2009 - 2009	493804			520923	
Road Star Warrior XV 1700PC	1700	2003 - 2005	493804			520923	
V-Max VMX 17	1700	2009 - 2016	490556			520922	490512
Midnight Star XV 1900A	1900	2006 - 2016	493804			520923	
Midnight Star XV 1900ACFD	1900	2014 - 2016	493804			520923	
ZONTES							
125 GK	125	2022 - 2023	519520				
125 HYPER TRAIL 125	125	2020 - 2023	519520				
125 M	125	2022 - 2023	490331			520922	483849
125 ROADSTER 125	125	2020 - 2023	519520				
125 SCRAMBLER 125	125	2020 - 2023	519520				
125 URBAN 125	125	2020 - 2023	519520				
310 M	310	2022 - 2023	490330			520922	490511
310 X, R1, R2, T, T2, V 310	310	2020 - 2023	519520				

MOTEUR

CYCLE

PNEUMATIQUE

ATELIER

ACCESSOIRES

ÉLECTRICITÉ

FILTRATION

FREINAGE

TRANSMISSION

COMMENT LIRE NOTRE NUMÉRO DE PIÈCE: BOUGIES

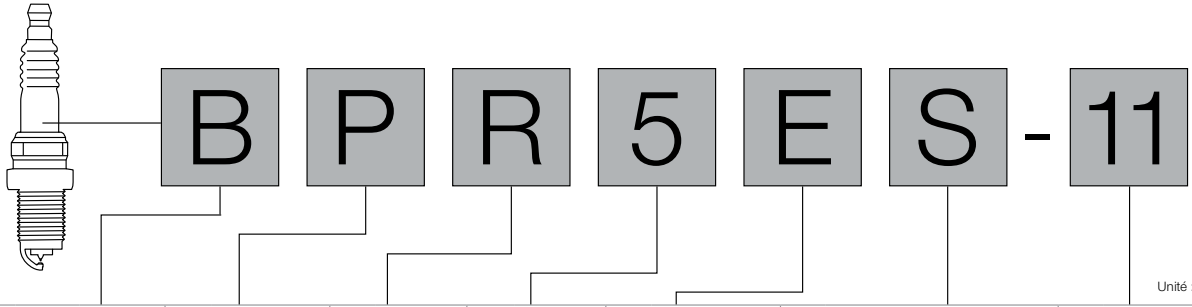

Unité : mm

B		P		R		5		E		S		-11			
	Diamètre de filetage	Hexagone	Structure		Résistance antiparasitage		Indice thermique		Longueur du filetage		Caractéristiques de conception		Ecartement		
A	∅ 18,0	Hex 25,4	P	Isolant proéminent	R	Résistance	2		E	19,0	B	Olive SAE monbloc (CR8EB)	vide	Moto : 0,7-0,8 Automobile : 0,8-0,9	
B	∅ 14,0	Hex 20,8			Z	Inductance intégrée	4		EH	17,5					CM
BC	∅ 14,0	Hex 16,0	M	Bougie compacte		5	EH		19,0 semi-filetage Culot 19 mm Filetage 12,7	CS	Électrode de masse inclinée	-8	0,8		
BK	∅ 14,0	Hex 16,0				6								H	12,7
C	∅ 10,0	Hex 16,0	U	Décharge superficielle ou à étincelle semi-surfacique		7	L		11,2	I	Électrode centrale en iridium	-10	1,0		
D	∅ 12,0	Hex 18,0				8								IX	Gamme Iridium IX
DC	∅ 12,0	Hex 16,0	9	vide		Siège conique A(P)-F : 10,9 B(P)-F : 11,2 BM(P)-F : 7,8	J		2 électrodes de masse à projection	-13	1,3				
E	∅ 8,0	Hex 13,0	10									Type froid	Bougie de petite taille B(P)M- : 9,5 B(L)M- : 9,5 CM- : 9,5 CM-6 : 8,6 C-50 : 8,5	K	2 électrodes de masse
<p>* Exception B(P)M-A,Y : ∅ 14,0, Hex 19,0 P(P)-(E)F : ∅ 14,0, Hex 16,0 CM-6 : ∅ 10,0, Hex 14,0</p> <p>BC : Ancienne taille standard JIS La longueur entre le circuit du joint et le contact de la borne est de 53 mm.</p> <p>BK : Taille standard ISO/JIS La longueur entre le circuit du joint et le contact de la borne est de 50,5 mm.</p>															
													-S	Joint spécifique	
															-E
													IX-P	Bougie Iridium MAX	
															LPG 1-8
													Q	4 électrodes de masse	
															S
													T	3 électrodes de masse	
															U
													Y	Électrode centrale à gorge en V - Proéminence sup. à 1mm	
															Z



COMMENT LIRE NOTRE NUMÉRO DE PIÈCE: BOUGIES

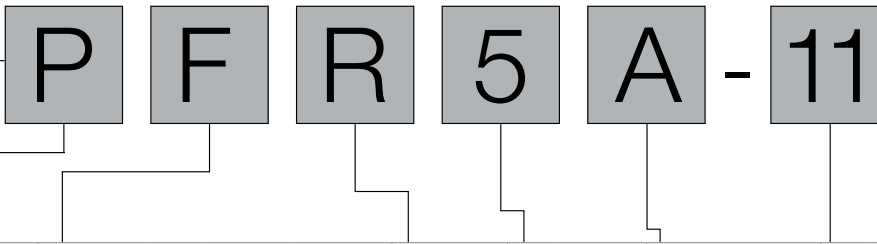
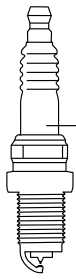

Unité : mm

P		F				R	5	A	-11			
Type		Diamètre de filetage	Longueur de filetage	Configuration du siège	Hexagone	Résistance antiparasitage	Indice thermique	Conception	Distance entre les électrodes			
DI	Haute capacité d'allumage : technologie DFE	F	14,0	19,0	Joint	Hex 16,0		A,B,C... code suffixe	leer	Moto : 0,7-0,8		
		FE	14,0	19,0	Joint	Hex 16,0				Automobile : 0,8-0,9		
I	Bougie d'allumage double à l'Iridium	G	14,0	19,0	Joint	Hex 20,8			-7	0,7		
L	Filetage extra-long de 26,5mm	J	12,0	19,0	Joint	Hex 18,0			-9	0,9		
P	Bougie d'allumage double à la platine	K	12,0	19,0	Joint	Hex 16,0			I	Électrode centrale en Iridium	-10	1,0
S	Bougie haute sensibilité à l'allumage : type à pointe carrée fine	KA	12,0	19,0	Joint	Hex 14,0					-11	1,1
Z	Extrémité d'allumage projetée	KB	12,0	19,0	Siège conique	Bi-Hex 14,0 (Bi-hexagonal *)					-13	1,3
Les caractéristiques citées ci-dessus peuvent être combinées. <Exemple>ILFR... PLZFR... Quand « L » est inclus, la priorité est donnée au « L » (longue portée) pour la longueur de filetage. <Exemple> *Bougie avec joint d'étanchéité FR5AP : longueur de filetage 19,0mm ↓ LFR5AP-11 : longueur de filetage 26,5mm *Bougie à siège conique PTR5C-13 : longueur de filetage 17,5mm ↓ PLTR6A-10G : longueur de filetage 25,0mm	KE	12,0	19,0	Joint	Hex 16,0	R			Résistance 2 4 5 6 7 8 9 10 Type froid	Conception * Quand il y a « I » ou « P » au début du numéro de pièce (« I » ou « P » après la valeur thermique devient un code de suffixe.) <Exemple> IZFR6PB est une bougie à l'Iridium ! : Iridium P : Code de suffixe * <Exception> ZFR6P-G est une bougie d'allumage au nickel	Distance entre les électrodes -A Sans joint d'étanchéité -D Corps métallique : nickelé -E Résistance spéciale -G Électrode de masse à cœur en cuivre -H Filetage spécial -J 2 électrodes de masse -K Électrode de masse résistante aux vibrations -N Électrode de masse spéciale -Q 4 électrodes de masse -S Joint spécifique -T 3 électrodes de masse -U Type à décharge sur demi-surface IX-P Bougie Iridium MAX LPG 1-8 Gamme de bougies d'allumage LaserLine pour moteurs à gaz	
	KF	12,0	19,0	Joint	Hex 14,0							
	KG	12,0	19,0	Joint	Bi-Hex 14,0 (Bi-hexagonal *)							
	L	10,0	12,7	Joint	Hex 16,0							
	M	10,0	19,0	Joint	Hex 16,0							
	MA	10,0	19,0	Joint	Hex 14,0							
	MF	10,0	19,0	Joint	Hex 14,0							
	NA	12,0	17,5	Siège conique	Hex 14,0							
	T	14,0	17,5	Siège conique	Hex 16,0							
	U	14,0	11,2	Siège conique	Hex 16,0							
W	18,0	10,9	Siège conique	Hex 20,8								
X	14,0	9,5	Joint	Hex 20,8								
Y	14,0	11,2	Siège conique	Hex 16,0								
					Bi-hexagonal							
					Hexagonal							
					* Exception TR5A-10, TR5A-13, TR5B-13, TR6B-10, TR6B-13, PTR5A-10, PTR5A-13 : Longueur de filetage 25 mm							
					* Une douille bi-hexagonale est nécessaire.							
					* FE, KE, KF, KG, MF : Type à longueur d'isolant exposé plus longue							





RE		7	C	-L			
Type		Indice thermique	Conception	Distance entre les électrodes			
RE	Bougie pour moteurs rotatifs		A,B,C... code suffixe	-L Face avant			
SD	Bougie pour moteurs rotatifs (écartement des électrodes à décharge sur demi-surface)			5	-T Face arrière	6	
				6		7	
				7		8	
				8		9	
				9		10	
10	11						



HB		6	A				IX	-11		P
Type		Indice thermique	Diamètre de filetage	Longueur de filetage	Configuration du siège	Hexagone	IX	Distance entre les électrodes		P
HB	HYBD (type hybride à 3 électrodes de masse)		A	14,0	20,5	Joint	IX	-8 0,8		
								-9 0,9		
								-10 1,0		
								-11 1,1		
								-13 1,3		





DF		6	H				-11		A		
Type		Indice thermique	Diamètre de filetage	Longueur de filetage	Configuration du siège	Hexagone	Distance entre les électrodes		A		
DF	Bougie haute sensibilité à l'allumage		A	14,0	19,0	Joint	-8	0,8		A,B,C... code suffixe	
								-9 0,9			
DFH	Bougie haute sensibilité à l'allumage (DF + type hybride)		6	B	14,0	26,5	Joint	-10	1,0		
			7						*DF6H-11A : Longueur de filetage 28,0 mm		
			8						-11 1,1		
			9	-13 1,3			-15	1,5			



Modèle	Cylindrée	Année	Bougie	 		
				Ref CGN standard	Bougie iridium	Ref CGN iridium
ADLY						
Activator 125	125	99-	CR7HSA	1861	CR7HIX	496398
AJP 125 PR4	125	03-	DPR7EA-9	198282	DPR7EIX-9	512580
Cat 125	125	97-	CR7HSA	1861	CR7HIX	496398
ALFER						
AR-1, GR 300 Agua, TX-300	300	-	B8ES	1843	BR8EIX	381507
EGR 250 Agua, EGR 250 Air	250	-	B8ES	1843	BR8EIX	381507
GR 125 ISDE	125	-	-	-	BR8EIX	381507
MC 125	125	-	-	-	BR9EIX	381511
MC 250	250	-	-	-	BR9EIX	381511
MC 500	490	-	-	-	BR9EIX	381511
Trial	125	00-	CR9EB	328861	CR9EIX	381550
VR 250 Enduro 2 temps	250	-	BR8ES	1889	BR8EIX	381507
VR 250 no limit Supermoto 2 temps	250	-	BR8ES	1889	BR8EIX	381507
VR 250 Super Motard	250	00-	BR8ES	1889	BR8EIX	381507
VRE 125 4 temps	125	-	CR9E	1863	CR9EIX	381550
VRE 125 4 temps No limit	125	-	CR9E	1863	CR9EIX	381550
APRILIA						
AF1 125 Moteur	125	88-	BR10EG	198172	BR10EIX	381617
Atlantic 125	125	03-	CR8EB	384085	CR8EIX	490470
Atlantic 200	200	02-05	CR8EB	384085	CR8EIX	490470
Atlantic 250	250	04-06	CR8EB	384085	CR8EIX	490470
Atlantic 250 i.e.	250	04-09	PMR8B	512439	-	-
Atlantic 300	278	09-	CR8EKB	496381	CR8EIX	490470
Atlantic 300 ie	300	10-13	CR8EKB	496381	CR8EIX	490470
Atlantic 400 ie	400	06-09	CR7EKB	450805	CR7EIX	490469
Atlantic 500	500	02-04	CR7EKB	450805	CR7EIX	490469
Atlantic 500 Sprint	500	02-08	CR7EKB	450805	CR7EIX	490469
Atlantic Sprint	400	06-	CR7EKB	450805	CR7EIX	490469
Caponord 1200	1200	13-	CR8EKB	496381	CR8EIX	490470
Classic 125 11KW	125	96-02	BR8ES	1889	BR8EIX	381507
Classic 125 Full Power	125	96-02	BR10EG	198172	BR10EIX	381617
Dorsoduro 1200	1200	10-	CR9EKB	496397	CR9EIX	381550
Dorsoduro 750	750	08-16	CR7EKB	450805	CR7EIX	490469
Dorsoduro 750 Factory	750	07-16	CR7EKB	450805	CR7EIX	490469
Dorsoduro 900 4 Stroke	900	17-	CR8EKB	496381	CR8EIX	490470
ETV 1000 Caponord	1000	01-08	DCPR9E	213989	DCPR9EIX	512581
ETX 125	125	84-98	B9ES	1844	BR9EIX	381511
ETX 125 Full Power	125	98-	BR10EG	198172	BR10EIX	381617
ETX 125 Moteur Rotax	125	99-02	BR8ES	1889	BR8EIX	381507
Europa 125	125	90-	BR10EG	198172	BR10EIX	381617
Grande 250	250	11-13	PMR8B	512439	-	-



Modèle	Cylindrée	Année	Bougie			
				Ref CGN standard	Ref CGN iridium	
Habana 125, Habana Custom 125	125	99-01	CR7E	213902	CR7EIX	490469
Leonardo (PD) (SV)	300	98-00	DR7EA	496396	DR7EIX	512413
Leonardo 125	125	95-01	CR8E	1862	CR8EIX	490470
Leonardo 125 ST	125	96-	CR8E	1862	CR8EIX	490470
Leonardo 125 ST	125	02-06	CR8EB	384085	CR8EIX	490470
Leonardo 150	150	97-02	CR8E	1862	CR8EIX	490470
Leonardo 150 ST	150	99-	CR8E	1862	CR8EIX	490470
Leonardo 150 ST	150	02-06	CR8E	1862	CR8EIX	490470
Leonardo 250	250	99-	DR8EA	198225	DR8EIX	493825
Leonardo 250	278	98-04	DR8EA	198225	DR8EIX	493825
Leonardo 300	300	04-07	DR7EA	496396	DR7EIX	512413
Leonardo ST	300	05-	DR8EA	198225	DR8EIX	493825
Mana 850	850	07-16	CR7EKB	450805	CR7EIX	490469
Mana 850 GT	850	09-16	CR7EKB	450805	CR7EIX	490469
Mojito 125	125	02-04	CR8E	1862	CR8EIX	490470
Mojito 150	150	03-06	CR7EB	450804	CR7EIX	490469
Mojito Custom 125	125	02-	CR7EB	450804	CR7EIX	490469
Mojito Custom 125	125	05-	CR9E	1863	CR9EIX	381550
Moto 650 Moto 6.5	650	95-02	D8EA	1855	DR8EIX	493825
MX 125	125	04-06	BR8ES	1889	BR8EIX	381507
MXV 4.5	450	09-15	CR8EKB	496381	CR8EIX	490470
Pegaso 125	125	90-96	B10EG	1870	-	-
Pegaso 125	125	92-96	BR10EG	198172	BR10EIX	381617
Pegaso 650	650	92-95	DR8EA	198225	DR8EIX	493825
Pegaso 650 Carburettor	650	93-00	D8EA	1855	DR8EIX	493825
Pegaso 650 Cube	650	96-00	DR8EA	198225	DR8EIX	493825
Pegaso 650 Factory	650	07-09	CR7E	213902	CR7EIX	490469
Pegaso 650 i.e.	650	01-05	DR8EB	512441	DR8EIX	493825
Pegaso 650 i.e. Ø12mm	650	01-04	DR8EB	512441	DR8EIX	493825
Pegaso 650 Strada	660	06-09	CR7E	213902	CR7EIX	490469
Pegaso 650 Strada Injection	650	05-	CR7E	213902	CR7EIX	490469
Pegaso 650 Trail	650	06-09	CR7E	213902	CR7EIX	490469
Red Rose 125	125	88-95	B10EG	1870	-	-
RS 125	125	92-97	BR10EG	198172	BR10EIX	381617
RS 125 Extrema	125	93-	BR10EG	198172	BR10EIX	381617
RS 125 Full Power	125	96-	BR8ES	1889	BR8EIX	381507
RS 125 Full Power	125	96-	BR10EG	198172	BR10EIX	381617
RS 125 Limited power 11kW	125	96-	BR8ES	1889	BR8EIX	381507
RS 125 R Extrema 12HP	125	93-	BR8ES	1889	BR8EIX	381507
RS 125 R Extrema 35BHP Unrestricted	125	93-	BR10EG	198172	BR10EIX	381617
RS 125 Replica	125	93-	BR10EG	198172	BR10EIX	381617
RS 125 Tuono	125	03-	BR8ES	1889	BR8EIX	381507

Modèle	Cylindrée	Année	Bougie	 		
				Ref CGN standard	Bougie iridium	Ref CGN iridium
RS 250	250	94-	BR9ECM	214181	BR9ECMIX	496382
RS 250	250	95-00	BR9ECM	214181	BR9ECMIX	496382
RS4	125	11-	CR9EB	328861	CR9EIX	381550
RST 1000 Futura	1000	01-04	DCPR9E	213989	DCPR9EIX	512581
RSV 1000	1000	99-04	DCPR9E	213989	DCPR9EIX	512581
RSV 1000	1000	05-09	DCPR9E	213989	DCPR9EIX	512581
RSV 1000 Mille	1000	98-00	DCPR8E	512442	DCPR8EIX	496403
RSV 1000 Mille	1000	01-03	DCPR9E	213989	DCPR9EIX	512581
RSV 1000 Mille Factory	1000	04-05	DCPR9E	213989	DCPR9EIX	512581
RSV 1000 Mille R	1000	99-01	DCPR8E	512442	DCPR8EIX	496403
RSV 1000 Mille R	1000	02-05	DCPR9E	213989	DCPR9EIX	512581
RSV 1000 Mille SP	1000	00-	R0045Q-10	512443	-	-
RSV 1000 Mille Tuono	1000	02-03	DCPR9E	213989	DCPR9EIX	512581
RSV 1000 Mille Tuono Fighter	1000	03-	DCPR9E	213989	DCPR9EIX	512581
RSV 1000 Mille Tuono R	1000	02-03	DCPR9E	213989	DCPR9EIX	512581
RSV 1000 Mille Tuono Racing	1000	03-	DCPR9E	213989	DCPR9EIX	512581
RSV 1000 R	1000	04-	DCPR9E	213989	DCPR9EIX	512581
RSV 1000 R	1000	00-04	DCPR9E	213989	DCPR9EIX	512581
RSV 1000 R Factory	1000	04-	DCPR9E	213989	DCPR9EIX	512581
RSV 1000 R Factory	1000	05-09	DCPR9E	213989	DCPR9EIX	512581
RSV 1000 R NERA	1000	04-	DCPR9E	213989	DCPR9EIX	512581
RSV 1000 SP	1000	99-00	R0045Q-10	512443	-	-
RSV 1000 Tuono R	1000	02-	DCPR9E	213989	DCPR9EIX	512581
RSV 1000 Tuono V4, V4R	1000	11-	CR9EKB	496397	CR9EIX	381550
RSV4 1000 APRC R	1000	11-	CR9EB	328861	CR9EIX	381550
RSV4 1000 APRC R Factory	1000	11-	CR9EB	328861	CR9EIX	381550
RSV4 1000 Factory	1000	09-	CR9EB	328861	CR9EIX	381550
RSV4 1000 Factory SPRC SE	1000	10-	CR9EB	328861	CR9EIX	381550
RSV4 1000 R	1000	10-	CR9EB	328861	CR9EIX	381550
RX 125	125	90-02	B10EG	1870	-	-
RX 125	125	94-96	BR10EG	198172	BR10EIX	381617
RX 125 Full Power	125	08-	BR10EG	198172	BR10EIX	381617
RX 125 Limited power 11kW	125	08-	BR8ES	1889	BR8EIX	381507
RXV 4.5	450	06-13	CR8EKB	496381	CR8EIX	490470
RXV 5.5	550	06-13	CR8EKB	496381	CR8EIX	490470
Scarabeo	300	09-	CR8EKB	496381	CR8EIX	490470
Scarabeo 125	125	99-09	CR8EB	384085	CR8EIX	490470
Scarabeo 125 GT	125	02-07	CR8EB	384085	CR8EIX	490470
Scarabeo 125 i.e.	125	09-	PMR9B	512438	-	-
Scarabeo 150	150	99-03	CR8E	1862	CR8EIX	490470
Scarabeo 200	200	00-09	CR8EB	384085	CR8EIX	490470
Scarabeo 200 4stroke	200	00-	CR8E	1862	CR8EIX	490470



Modèle	Cylindrée	Année	Bougie	 		
				Ref CGN standard	Bougie iridium	Ref CGN iridium
Scarabeo 200 i.e.	200	09-	PMR9B	512438	-	-
Scarabeo 250	250	04-10	PMR8B	512439	-	-
Scarabeo 250	250	04-06	CR8EB	384085	CR8EIX	490470
Scarabeo 250 ie	250	06-	CR8EB	384085	CR8EIX	490470
Scarabeo 250 ie	250	06-	PMR8A	512440	-	-
Scarabeo 300 Special	278	09-	CR8EKB	496381	CR8EIX	490470
Scarabeo 400	400	07-	CR7EKB	450805	CR7EIX	490469
Scarabeo 500	500	02-05	CR7EKB	450805	CR7EIX	490469
Scarabeo 500 ABS	500	04-06	CR7EKB	450805	CR7EIX	490469
Scarabeo Light	125	99-	CR8E	1862	CR8EIX	490470
Scarabeo Special	300	-	BP5ES	490456	BPR5EIX	511478
Scarabeo Special	300	-	CR8EKB	496381	CR8EIX	490470
Scarabeo Street	125	06-	CR9EB	328861	CR9EIX	381550
Scarabeo Street	200	06-	CR9EB	328861	CR9EIX	381550
Shiver 750	750	07-16	CR7EKB	450805	CR7EIX	490469
Shiver 750 GT	750	09-	CR7EKB	450805	CR7EIX	490469
Shiver 900	900	17-	CR8EKB	496381	CR8EIX	490470
SL 1000 Falco 4 Stroke	1000	99-04	DCPR9E	213989	DCPR9EIX	512581
SL 750 Shiver	750	07-	CR7EKB	450805	CR7EIX	490469
Sportcity 125	125	04-08	CR8E	1862	CR8EIX	490470
Sportcity 200	200	04-08	CR7EB	450804	CR7EIX	490469
Sportcity 200 Cube	200	08-	CR8EB	384085	CR8EIX	490470
Sportcity 250	250	04-	CR8EB	384085	CR8EIX	490470
Sportcity 250 ie	250	06-08	PMR8B	512439	-	-
Sportcity 300 ie Cube	300	08-	CR8EKB	496381	CR8EIX	490470
Sportcity 300 ie Cube	300	09-13	CR8EKB	496381	CR8EIX	490470
Sportcity Cube 125	125	08-	CR8EB	384085	CR8EIX	490470
Sportcity Cube 300	278	08-	CR8EKB	496381	CR8EIX	490470
Sportcity One 125	125	08-	CR7EB	450804	CR7EIX	490469
Square Four Mk II	1000	-	B6ES	1841	-	-
SR 125	125	99-02	BR8ES	1889	BR8EIX	381507
SR 125 AC	125	00-	BR8ES	1889	BR8EIX	381507
SR 125 MAX	125	11-	CR8EKB	496381	CR8EIX	490470
SR 125 Motard	125	12-	CR7EB	450804	CR7EIX	490469
SR 150	150	99-02	BR9ES	1890	BR9EIX	381511
SR 300 MAX	300	11-	CR8EKB	496381	CR8EIX	490470
SRV 850	850	12-	CR7EKB	450805	CR7EIX	490469
SX 125	125	08-	BR10EG	198172	BR10EIX	381617
SX 125 11kW	125	08-	BR8ES	1889	BR8EIX	381507
SXV 4.5	450	06-15	CR8EKB	496381	CR8EIX	490470
SXV 5.5	550	06-15	CR8EKB	496381	CR8EIX	490470
Tuareg 600	600	88-	D8EA	1855	DR8EIX	493825

MOTEUR

CYCLE

PNEUMATIQUE

ATELIER

ACCESSOIRES

ÉLECTRICITÉ

FILTRATION



FREINAGE

TRANSMISSION



Modèle	Cylindrée	Année	Bougie	 		
				Ref CGN standard	Bougie iridium	Ref CGN iridium
Tuono 1000 incl. ABS	1000	02-04	DCPR9E	213989	DCPR9EIX	512581
Tuono 1000 R, R Factory	1000	05-10	DCPR9E	213989	DCPR9EIX	512581
Tuono 1100 V4	1100	11-	CR9EKB	496397	CR9EIX	381550
Tuono 1100 V4 Factory, V4 RR incl. ABS	1100	15-	CR9EKB	496397	CR9EIX	381550
Tuono 125 11kW	125	03-04	BR8ES	1889	BR8EIX	381507
Tuono Factory	1000	06-	DCPR9E	213989	DCPR9EIX	512581
Tuono V4 R	1000	11-14	CR9EKB	496397	CR9EIX	381550
ARCTIC CAT - SSV						
Prowler 4x4 Flatbed	550	09	CPR8E	336134	-	-
Prowler H1 4x4 Auto	650	07-08	CPR8E	336134	-	-
Prowler HDX LTD PS EFI 4x4 UTV	500	14	CR7E	213902	CR7EIX	490469
Prowler HDX LTD PS EFI 4x4 UTV	650	14	CPR8E	336134	-	-
Prowler HDX XT	500	14	CR7E	213902	CR7EIX	490469
Prowler HDX, Prowler HDX EFI 4x4 UTV	500	14	CR7E	213902	CR7EIX	490469
Prowler XDX	700	14	CPR8E	336134	-	-
Prowler XDX EFI 4x4 UTV	700	12	CPR8E	336134	-	-
Prowler XDX EFI PS 4x4 UTV	700	13	CPR8E	336134	-	-
Prowler XDX, XTX H1 EFI 4x4 UTV	700	11	CPR8E	336134	-	-
Prowler XT 4x4	700	09	CPR8E	336134	-	-
Prowler XT 4x4 Auto	650	09	CPR8E	336134	-	-
Prowler XT EFI 4x4 UTV	550	12-13	CPR8E	336134	-	-
Prowler XT H1 4x4 Auto	650	06-08	CPR8E	336134	-	-
Prowler XT H1 EFI 4x4 UTV	550	10-11	CPR8E	336134	-	-
Prowler XT, Prowler XT EFI 4x4 UTV	550	14	CPR8E	336134	-	-
Prowler XTX 4x4, XTX LE 4x4	700	09	CPR8E	336134	-	-
Prowler XTX EFI 4x4 UTV	700	12	CPR8E	336134	-	-
Prowler XTX EFI PS 4x4 UTV	700	13	CPR8E	336134	-	-
Prowler XTX H1 4x4 Auto	700	08	CPR8E	336134	-	-
Prowler XTX H1 EFI 4x4 UTV	700	10	CPR8E	336134	-	-
Prowler XTX, Prowler XTX PS EFI 4x4 UTV	700	14	CPR8E	336134	-	-
Prowler XTZ 4x4	1000	14	CPR8E	336134	-	-
Prowler XTZ EFI 4x4 UTV	1000	12	CPR8E	336134	-	-
Prowler XTZ EFI PS 4x4 UTV	1000	13	CPR8E	336134	-	-
Prowler XTZ H2 4x4	1000	09	CPR8E	336134	-	-
Prowler XTZ H2 4x4 Baja	1000	09	CPR8E	336134	-	-
Prowler XTZ H2 EFI 4x4 UTV	1000	10	CPR8E	336134	-	-
Prowler XTZ H2 EFI 4x4 UTV	1000	11	CPR8E	336134	-	-
Prowler XTZ PS EFI 4x4 UTV	1000	14	CPR8E	336134	-	-
Wildcat	1000	13-15	CPR8E	336134	-	-
Wildcat 4	1000	13-14	CPR8E	336134	-	-
Wildcat 4 LTD, 4 X, 4 X LTD	1000	14	CPR8E	336134	-	-
Wildcat GT	1000	12-13	CPR8E	336134	-	-



Modèle	Cylindrée	Année	NOK		NOK	
			Bougie	Ref CGN standard	Bougie iridium	Ref CGN iridium
Wildcat Late Build, Wildcat LTD Late Build	1000	13	CPR8E	336134	-	-
Wildcat LTD	1000	13-14	CPR8E	336134	-	-
Wildcat Sport, Wildcat Trail Cat	700	15	CR8EB	384085	CR8EIX	490470
Wildcat Trail	700	14-15	CR8EB	384085	CR8EIX	490470
Wildcat Trail XT	700	14-15	CR8EB	384085	CR8EIX	490470
Wildcat X	1000	13-15	CPR8E	336134	-	-
Wildcat X LTD (U2014WTWIP)	1000	14	CPR8E	336134	-	-
BAJAJ						
Chetak	125	-	BP5HS	512590	-	-
Chetak	150	-	BP5HS	512590	-	-
Chetak 125 Electr., Electr.D	125	-	BP6HS	490458	BPR6HIX	512414
Chetak 150 Classic, Classic Green, Classic Sidec, Electr.	150	-	BPR5HS	497111	-	-
Chetak 150 Electr.D	150	-	BPR5HS	497111	-	-
Chetak 150 Electr.D; Classic; Sidec; Green	150	-	BPR5HS	497111	-	-
Pulsar 200 NS	200	-	CPR8EA-9 LKAR8A-9	496384 507443	-	-
Vespa	125	93-	B6HS	1834	BR6HIX	497114
BASHAN						
BS 125 GY	125	01-	D8EA	1855	DR8EIX	493825
BS 200 GY	200	01-	D8EA	1855	DR8EIX	493825
Vixen VX250	250	06-	DR8EA	198225	DR8EIX	493825
BENELLI						
504	500	-	D8EA	1855	DR8EIX	493825
125	125	-	B6HS	1834	BR6HIX	497114
125-2C Twin	125	-	B7ES	1842	BR7EIX	497115
250	250	-	C7HSA	465600	CR7HIX	496398
250	250	-	B6ES	1841	-	-
2C	250	-	B7ES	1842	BR7EIX	497115
2CE	250	-	B7ES	1842	BR7EIX	497115
304	230	82-	B7HS	1835	BR7HIX	497113
354 Sei	350	80-	D8EA	1855	DR8EIX	493825
500 LS	500	-	D8EA	1855	DR8EIX	493825
500 Quattro	500	-	D8EA	1855	DR8EIX	493825
504 Sport	500	-	D8EA	1855	DR8EIX	493825
654, 4C, Sport	650	-	D8EA	1855	DR8EIX	493825
Adiva 150	150	01-06	CR8E	1862	CR8EIX	490470
Adiva 150	150	-	CR8EB	384085	CR8EIX	490470
BN 302	300	14-	CR9EB	328861	CR9EIX	381550
BN 600 GT, I, R	600	14-	CR9E	1863	CR9EIX	381550
Caffé Nero 250	250	08-	DPR8EA-9	1857	DPR8EIX-9	496388
Caffé Nero 250	250	12-	CR8E	1862	CR8EIX	490470
Century Racer 899	900	10-	CR9E	1863	CR9EIX	381550
Cross 125	125	-	B7ES	1842	BR7EIX	497115

Modèle	Cylindrée	Année	Bougie	 		
				Ref CGN standard	Bougie iridium	Ref CGN iridium
Dusk 400	400	05-	CR9E	1863	CR9EIX	381550
Jarno	125	-	B8ES	1843	BR8EIX	381507
Macis 125	125	10-	CR8E	1862	CR8EIX	490470
Macis 150	150	10-	CR8E	1862	CR8EIX	490470
Roadster	125	-	B7ES	1842	BR7EIX	497115
Scooter S, Scooter S-125	125	-	B7HS	1835	BR7HIX	497113
Sei 750	750	-	D8EA	1855	DR8EIX	493825
Sei 900 NT, VT	900	-	D8EA	1855	DR8EIX	493825
Sport Speciale	250	-	B7ES	1842	BR7EIX	497115
Super	250	-	B8ES	1843	BR8EIX	381507
TNT 1130	1130	04-	CR9E	1863	CR9EIX	381550
TNT 1130 Cafe Racer	1130	06-	CR9E	1863	CR9EIX	381550
TNT 1130 Century Racer	1130	10-	CR9E	1863	CR9EIX	381550
TNT 1130 K	1130	04-	CR9E	1863	CR9EIX	381550
TNT 1130 Sport Evo	1130	06-	CR9E	1863	CR9EIX	381550
TNT 1130 Titanium	1130	06-	CR9E	1863	CR9EIX	381550
TNT 899 Café Racer	900	09-	CR9E	1863	CR9EIX	381550
TNT 899 S-Tornado Naked	900	08-	CR9E	1863	CR9EIX	381550
TNT 899, 899 Sport	900	07-	CR9E	1863	CR9EIX	381550
TNT R160	1130	09-	CR9E	1863	CR9EIX	381550
TNT R160	1130	10-	CR9EB	328861	CR9EIX	381550
Tornado 1130 Tre	1130	-	CR9E	1863	CR9EIX	381550
Tornado 650, S, SV	650	-	B8ES	1843	BR8EIX	381507
Tornado 900	900	00-	CR9E	1863	CR9EIX	381550
Tornado 900 IE	900	02-	-	-	CR8EIX	490470
Tornado 900 LE	900	05-	C7E	512444	CR7EIX	490469
Tornado 900 Limited Edition	900	00-	CR9E	1863	CR9EIX	381550
Tornado 900 RS, Tre	900	05-	C7E	512444	CR7EIX	490469
Tornado Tre K, Tre-K 1130	1130	06-	CR9E	1863	CR9EIX	381550
Tre-K 1130 Amazonas	1130	07-	CR9E	1863	CR9EIX	381550
Tre-K 899	900	09-	CR9EB	328861	CR9EIX	381550
Velvet	250	00-	CR8E	1862	CR8EIX	490470
Velvet 250 MY08	250	08-	DPR8EA-9	1857	DPR8EIX-9	496388
Velvet 400	400	03-04	CR9E	1863	CR9EIX	381550
Velvet Eco 125	125	99-	CR8E	1862	CR8EIX	490470
Velvet Eco 150	150	99-	CR8E	1862	CR8EIX	490470
Velvet Eco 250	250	00-07	DR8EA	198225	DR8EIX	493825
BETA / BETAMOTOR						
Alp 125	125	-	DR8EA	198225	DR8EIX	493825
Alp 125	125	-06	CR7HSA	1861	CR7HIX	496398
Alp 125	125	07-	CR7HSA	1861	CR7HIX	496398
Alp 125 2T	125	98-99	BPR7ES	1848	BPR7EIX	512582



Modèle	Cylindrée	Année	Bougie	 		
				Ref CGN standard	Bougie iridium	Ref CGN iridium
Alp 125 4T	125	00-	DR8EA	198225	DR8EIX	493825
Alp 200	200	-	DR8EA	198225	DR8EIX	493825
Alp 240	240	95-	B8ES	1843	BR8EIX	381507
Alp 250	250	-	B8ES	1843	BR8EIX	381507
Alp 260, Super Trail 260, Synt 260	260	-	B8ES	1843	BR8EIX	381507
Alp 4.0	400	04-	CR9EK	213936	CR9EIX	381550
Alp 4.0 4T	350	03-	CR9EK	213936	CR9EIX	381550
Alp 4-T	200	00-	DR8EA	198225	DR8EIX	493825
Alp LC	250	95-	BPR7ES	1848	BPR7EIX	512582
Dougie Lampkin Replica	247	-	BPR7ES	1848	BPR7EIX	512582
E6G	125	-	B7HS	1835	BR7HIX	497113
Eikon 125	125	99-	DR8EA	198225	DR8EIX	493825
Eikon 125	125	99-	DPR7EA-9	198282	DPR7EIX-9	512580
Eikon 150	150	99-	DPR7EA-9	198282	DPR7EIX-9	512580
Eikon 150, Eikon	250	99-	DPR7EA-9	198282	DPR7EIX-9	512580
Enduro	125	-	B7HS	1835	BR7HIX	497113
Enduro	250	-	B7HS	1835	BR7HIX	497113
Euro 350, Jonathan 350	350	-	CR9EK	213936	CR9EIX	381550
Euro Cruiser	125	-	DR8EA	198225	DR8EIX	493825
EVO 125 2T	125	08-	BR7ES	455372	BR7EIX	497115
EVO 200 2T	200	08-	BR7ES	455372	BR7EIX	497115
EVO 250 2T	250	08-	BR7ES	455372	BR7EIX	497115
EVO 250 4T	250	08-	CR7EB	450804	CR7EIX	490469
EVO 290 2T	290	08-	BR7ES	455372	BR7EIX	497115
EVO 300 4T	300	08-	CR7EB	450804	CR7EIX	490469
Jonathan	125	00-	DR8EA	198225	DR8EIX	493825
M4 4T	350	-	CR9EK	213936	CR9EIX	381550
Minicross R 125 4T	125	-	C7HSA	465600	CR7HIX	496398
Minicross R125 4T	125	08-	CR7HSA	1861	CR7HIX	496398
Minimotard R125 4T	125	09-	CR7HSA	1861	CR7HIX	496398
Motard 4.0 4T	350	03-	CR9EK	213936	CR9EIX	381550
RE 125 4T	125	06-	CR7HSA	1861	CR7HIX	496398
REV-3	270	-	BR7ES	455372	BR7EIX	497115
REV-3 125 Trial	125	00-	BP6ES	490457	BPR6EIX	512415
REV-3 125 Trial	125	00-06	B8ES	1843	BR8EIX	381507
REV-3 125 Trial	125	06-	BPR7ES	1848	BPR7EIX	512582
REV-3 125 Trial	125	-	BR7ES	455372	BR7EIX	497115
REV-3 200	200	-	BP6ES	490457	BPR6EIX	512415
REV-3 200 (Italie)	200	-	BR7ES	455372	BR7EIX	497115
REV-3 250	250	00-	BP6ES	490457	BPR6EIX	512415
REV-3 250	250	-	BPR7ES	1848	BPR7EIX	512582
REV-3 250 2T Trials	250	08-	BR7ES	455372	BR7EIX	497115

MOTEUR

CYCLE

PNEUMATIQUE

ATELIER



ACCESSOIRES

ÉLECTRICITÉ



FILTRATION



FREINAGE

TRANSMISSION



Modèle	Cylindrée	Année	Bougie	 		
				Ref CGN standard	Bougie iridium	Ref CGN iridium
REV-3 250 4T Trials	250	07-	CR7EB	450804	CR7EIX	490469
REV-3 270	270	-	BP6ES	490457	BPR6EIX	512415
REV-3 270 Trials	270	00-07	BPR7ES	1848	BPR7EIX	512582
REV-3 270 Trials	270	08-	BR7ES	455372	BR7EIX	497115
REV-3 Trials	200	00-07	BPR7ES	1848	BPR7EIX	512582
REV-3 Trials	200	08-	BR7ES	455372	BR7EIX	497115
RR 125 4T Motard	125	06-	CR7HSA	1861	CR7HIX	496398
RR 125 Enduro 4T	125	06-	CR7HSA	1861	CR7HIX	496398
RR 125 Enduro 4T (Ref.Liquide)	125	10-	CR8E	1862	CR8EIX	490470
RR 250	250	12-	BR8ES	1889	BR8EIX	381507
RR 250 M 4T	250	-	DCPR8E	512442	DCPR8EIX	496403
RR 300	300	12-	BR7ES	455372	BR7EIX	497115
RR 350 Enduro 4T	350	13-	LKAR8A-9	507443	-	-
RR 390 EFI Enduro, EFI Enduro Racing	390	15-	LKAR8A-9	507443	-	-
RR 400 4T Moteur Beta	400	10-	LKAR8A-9	507443	-	-
RR 400 4T Moteur KTM	400	-09	DCPR8E	512442	DCPR8EIX	496403
RR 430 EFI Enduro, EFI Enduro Racing	430	15-	LKAR8A-9	507443	-	-
RR 450 4T Moteur Beta	450	10-	LKAR8A-9	507443	-	-
RR 450 4T Moteur KTM	450	-	DCPR8E	512442	DCPR8EIX	496403
RR 480 EFI Enduro, EFI Enduro Racing	480	15-	LKAR8A-9	507443	-	-
RR 498 Enduro 4T	498	13-	LKAR8A-9	507443	-	-
RR 520 4T Moteur Beta	500	10-	LKAR8A-9	507443	-	-
RR 525 4T Moteur KTM	525	-	DCPR8E	512442	DCPR8EIX	496403
Super Trail 240	240	94-	B8ES	1843	BR8EIX	381507
Super Trail 250	250	-	B8ES	1843	BR8EIX	381507
Synt 125	125	94-	B8ES	1843	BR8EIX	381507
Techno 125	125	-	BPR7ES	1848	BPR7EIX	512582
Techno 200 Trial	200	-96	BR8ES	1889	BR8EIX	381507
Techno 200 Trial	200	96-	BPR7ES	1848	BPR7EIX	512582
Techno 250	250	-	BCP7ES	512592	BCPR7EIX	512416
Techno 250	250	96-99	BR8ES	1889	BR8EIX	381507
Techno 270 Trial	270	-96	BR8ES	1889	BR8EIX	381507
Techno 270 Trial	270	96-	BPR7ES	1848	BPR7EIX	512582
TR-32	125	-	B8ES	1843	BR8EIX	381507
TR-32	250	85-	B8ES	1843	BR8EIX	381507
TR-33	240	-	B6ES	1841	-	-
TR-34	125	-	B8ES	1843	BR8EIX	381507
TR-34, TR-35 Campionato	260	-	B8ES	1843	BR8EIX	381507
TR35	125	90-	B8ES	1843	BR8EIX	381507
Trial	125	-	B6ES	1841	-	-
Trial	240	-	B6ES	1841	-	-
Trial 240	240	-	B6ES	1841	-	-
Trial 250	250	-	BPR7ES	1848	BPR7EIX	512582



Modèle	Cylindrée	Année	Bougie	 		
				Ref CGN standard	Bougie iridium	Ref CGN iridium
Urban 125, 125 Special	125	09-	CR7HSA	1861	CR7HIX	496398
Urban 200	200	08-	DR8EA	198225	DR8EIX	493825
Urban 200 Special	200	09-	DR8EA	198225	DR8EIX	493825
Xtrainer 250 2T	250	-	GR7CI-8	512445	-	-
Xtrainer 300 2T	300	-	GR7CI-8	512445	-	-
Zero 125	125	-	B8ES	1843	BR8EIX	381507
Zero 260	260	-	B8ES	1843	BR8EIX	381507
Zero Gara	260	94-	B8ES	1843	BR8EIX	381507
BIMOTA						
BB 1 Biposto (Moteur BMW)	650	96-97	D8EA	1855	DR8EIX	493825
BB 1 Supermono (Moteur BMW)	650	95-96	D8EA	1855	DR8EIX	493825
BB 3 (Moteur BMW)	1000	14-	LMAR9D-J	512446	-	-
DB 2 (Moteur Ducati)	900	93-95	DPR8EA-9	1857	DPR8EIX-9	496388
DB 2 SR Half, Full Fairing (Moteur Ducati)	900	94-96	DPR8EA-9	1857	DPR8EIX-9	496388
DB 3 Mantra (Moteur Ducati)	900	96-	DPR8EA-9	1857	DPR8EIX-9	496388
DB 3 Mantra (Moteur Ducati)	904	95-98	DPR8EA-9	1857	DPR8EIX-9	496388
DB 4 (Moteur Ducati)	900	98-	DPR8EA-9	1857	DPR8EIX-9	496388
DB 4 Injection (Moteur Ducati)	900	00-	DCPR8E	512442	DCPR8EIX	496403
DB 5 (Moteur Ducati)	992	05-	DCPR8E	512442	DCPR8EIX	496403
DB 5 (Moteur Honda)	1100	05-06	DCPR8E	512442	DCPR8EIX	496403
DB 5S, DB 5R, Tesi 3D (Moteur Yamaha)	1100	10-	DCPR8E	512442	DCPR8EIX	496403
DB 6 (Moteur Honda)	1100	07-	DCPR8E	512442	DCPR8EIX	496403
DB 6 R Delirio (Moteur Ducati)	992	08-	DCPR8E	512442	DCPR8EIX	496403
DB 6R Delirio (Moteur Suzuki)	1100	08-	DCPR8E	512442	DCPR8EIX	496403
DB 7 (Moteur Suzuki)	1100	09-	MARIOA-J	512593	-	-
Mantra (Moteur Ducati)	900	-	DPR7EA-9	198282	DPR7EIX-9	512580
SB 6 (Moteur Ducati)	1100	94-96	CR9E	1863	CR9EIX	381550
SB 6R (Moteur Ducati)	1100	97-98	CR9E	1863	CR9EIX	381550
SB 7 (Moteur Suzuki)	750	94-95	CR9EK	213936	CR9EIX	381550
SB 8 R (Moteur Suzuki)	1000	-	CR9EK	213936	CR9EIX	381550
SB 8 R (Moteur Suzuki)	1000	98-99	CR9EK	213936	CR9EIX	381550
SB 8 R Special (Moteur Suzuki)	1000	-	CR9EK	213936	CR9EIX	381550
Tesi 1D SR, Tesi 1D ES (Moteur Ducati)	906	94-	-	-	DR9EIX	512583
V-Due	500	97-05	BR8ES	1889	BR8EIX	381507
V-Due Evoluzione	500	00-	-	-	DR8EIX	493825
YB 10 Biposto (Moteur Yamaha)	1000	95-	DR8EA	198225	DR8EIX	493825
YB 11 Superleggera (Moteur Yamaha)	1000	96-98	DR8EA	198225	DR8EIX	493825
YB 8 E Paioli, Evolution, Ohlins (Moteur Yamaha)	1000	94-	DR8ES-L	1859	DR8EIX	493825
YB 8 EXUP (Moteur Yamaha)	1000	95	DR8ES-L	1859	DR8EIX	493825
YB-9 SR, Sri (Moteur Yamaha)	600	94-96	CR9E	1863	CR9EIX	381550
BMW						
C 600 Sport K18	600	12-	LMAR8D-J	512447	-	-
C 650 GT K19	650	12-	LMAR8D-J	512447	-	-

Modèle	Cylindrée	Année	Bougie	 		
				Ref CGN standard	Bougie iridium	Ref CGN iridium
C 650 Sport K18	650	16-	LMAR8D-J	512447	-	-
C1 125	125	00-03	CR8EB	384085	CR8EIX	490470
C1 200	180	00-03	CR8EB	384085	CR8EIX	490470
F 650 BMS-C II	650	04-	DR8EB	512441	DR8EIX	493825
F 650 CS K14	650	00-05	DR8EB	512441	DR8EIX	493825
F 650 CS Scarver K14	650	01-	D8EA	1855	DR8EIX	493825
F 650 CS, GS, GS Dakar	650	02-05	DR8EB	512441	DR8EIX	493825
F 650 E169	650	93-03	D8EA	1855	DR8EIX	493825
F 650 GS Dakar R13	650	99-03	D8EA	1855	DR8EIX	493825
F 650 GS Dakar R13	650	03-07	DR8EB	512441	DR8EIX	493825
F 650 GS R13	650	99-03	D8EA	1855	DR8EIX	493825
F 650 GS R13	650	03-07	DR8EB	512441	DR8EIX	493825
F 650 GS R13	650	06-12	DCPR8E	512442	DCPR8EIX	496403
F 650 GS R13, GSD	650	00-02	DR8EB	512441	DR8EIX	493825
F 650 GS Sertão R13	650	10-	DR8EB	512441	DR8EIX	493825
F 650 GS, GS Dakar	650	05-07	DR8EB	512441	DR8EIX	493825
F 650 ST Strada E169	650	97-99	D8EA	1855	DR8EIX	493825
F 650, F 800 GS K72	800	08-	DCPR8E	512442	DCPR8EIX	496403
F 700 GS K70	800	13-17	DCPR8E	512442	DCPR8EIX	496403
F 750 GS K80	750	16-	LMAR8J-9E	512448	-	-
F 800 GS Adventure K75	800	12-	DCPR8E	512442	DCPR8EIX	496403
F 800 GT K71	800	13-	DCPR8E	512442	DCPR8EIX	496403
F 800 GT K71 90hp	800	11-	DCPR8E	512442	DCPR8EIX	496403
F 800 R K73	800	09-13	DCPR8E	512442	DCPR8EIX	496403
F 800 R K73 Chris Pfeiffer Replica	800	09-	DCPR8E	512442	DCPR8EIX	496403
F 800 S K71, ST K71	800	04-	DCPR8E	512442	DCPR8EIX	496403
F 800 S K71, ST K71	800	06-	DCPR8E	512442	DCPR8EIX	496403
F 850 GS K81	850	16-	LMAR8J-9E	512448	-	-
G 450 X K16	450	08-	CR9EKB	496397	CR9EIX	381550
G 650 GS R131	650	08-10	DR8EB	512441	DR8EIX	493825
G 650 GS R131	650	10-	DR8EB	512441	DR8EIX	493825
G 650 Xcountry K15	650	06-07	DR8EB	512441	DR8EIX	493825
G 650 Xcountry K15, Xchallenge K15, Xmoto K15	650	07-10	DR8EB	512441	DR8EIX	493825
HP2 Enduro - K25HP	1200	05-	BKR7EKC DCPR8EKC	496385 496383	BKR7EIX DCPR8EIX	512417 / 496403
HP2 Megamoto - K25 03	1200	07-	DCPR8EKC	496383	DCPR8EIX	496403
HP2 Sport - K29HP	1200	07-	MAR9B-JDS	512451	-	-
HP4 142 kW	1000	12-16	LMAR9D-J	512446	-	-
HP4 79kW	1000	12-16	LMAR9D-J	512446	-	-
HP4 Race	1000	17-	LMAR9D-J	512446	-	-
K 100 RS 4V K589VV	1000	89-	DR7EA	496396	DR7EIX	512413
K 100 RS K589 16 valves	1000	89-	DR7EA	496396	DR7EIX	512413
K 1100 LT 89V2 K589	1100	91-99	DCPR7E	496387	DCPR7EIX	512584



Modèle	Cylindrée	Année	Bougie	 		
				Ref CGN standard	Bougie iridium	Ref CGN iridium
K 1100 LT Edition spécial K589	1100	92-99	DR7EA	496396	DR7EIX	512413
K 1100 LT K589 72-74kW	1100	92-98	DR7EA	496396	DR7EIX	512413
K 1100 RS	1100	92-96	DR7EA	496396	DR7EIX	512413
K 1100 RS 89V2	1100	92-97	DCPR7E	496387	DCPR7EIX	512584
K 1200 GT - K41	1200	03-05	DCPR7E	496387	DCPR7EIX	512584
K 1200 GT - K44	1200	06-08	KR9CI	512595	-	-
K 1200 LT - K589	1200	98-04	DCPR7E	496387	DCPR7EIX	512584
K 1200 R - K43	1200	05-08	KR9CI	512595	-	-
K 1200 R Sport - K43	1200	05-07	KR9CI	512595	-	-
K 1200 RS - K589	1200	96-01	DCPR7E	496387	DCPR7EIX	512584
K 1200 S	1200	04-08	KR9CI	512595	-	-
K 1300 GT - K44	1300	07-10	KR9CI	512595	-	-
K 1300 R, S - K43	1300	07-	KR9CI	512595	-	-
K 1300 S Pack HP	1300	12-	KR9CI	512595	-	-
K 1600 B - K61 118kW	1600	17-	LMAR8AI-8	512452	-	-
K 1600 B - K61 79kW	1600	17-	LMAR8AI-8	512452	-	-
K 1600 GT, GTL - K48	1600	10-	LMAR8AI-8	512452	-	-
K 75 S K569, K 75 K569	750	85-96	D7EA	512594	DR7EIX	512413
R 100	1000	80-	BPR7ES	1848	BPR7EIX	512582
R 100 GS	1000	86-	BP6ES	490457	BPR6EIX	512415
R 100 R	1000	94-	BP6ES	490457	BPR6EIX	512415
R 100 R Mystik 247, 3	1000	93-96	BP6ES	490457	BPR6EIX	512415
R 100 RS	1000	86-	BP6ES	490457	BPR6EIX	512415
R 100 RT	1000	-	BPR7ES	1848	BPR7EIX	512582
R 100 RT	1000	87-96	BP6ES	490457	BPR6EIX	512415
R 100, CS	1000	-	BPR7ES	1848	BPR7EIX	512582
R 100, RT	1000	-	BPR7ES	1848	BPR7EIX	512582
R 1100 GS	1100	93-99	BKR7EKC	496385	BKR7EIX	512417
R 1100 GS 259	1100	99-	BKR7EKC	496385	BKR7EIX	512417
R 1100 GS 259E 59 kW	1100	99-	BKR7EKC	496385	BKR7EIX	512417
R 1100 R	1100	94-01	BKR7EKC	496385	BKR7EIX	512417
R 1100 RS	1100	92-01	BKR7EKC	496385	BKR7EIX	512417
R 1100 RT	1100	95-01	BKR7EKC	496385	BKR7EIX	512417
R 1100 S	1100	-99	BKR7EKC	496385	BKR7EIX	512417
R 1100 S	1100	99-03	BKR7EKC	496385	BKR7EIX	512417
R 1100 S	1100	03-	BKR7EKC DCPR8EKC	496385 496383	BKR7EIX DCPR8EIX	512417 / 496403
R 1100 S Boxer Cup 259S	1100	02-03	BKR7EKC	496385	BKR7EIX	512417
R 1100 S Tous modèles	1100	03-	BKR7EKC DCPR8EKC	496385 496383	BKR7EIX DCPR8EIX	512417 / 496403
R 1150	1150	03-	BKR7EKC DCPR8EKC	496385 496383	BKR7EIX DCPR8EIX	496403
R 1150 GS Adventure R21A	1150	02-03	BKR7EKC	496385	BKR7EIX	512417
R 1150 GS Adventure R21A	1150	03-05	BKR7EKC DCPR8EKC	496385	BKR7EIX DCPR8EIX	512417 / 496403

MOTEUR

CYCLE

PNEUMATIQUE

ATELIER



ACCESSOIRES

ÉLECTRICITÉ



FILTRATION

FREINAGE

TRANSMISSION

Modèle	Cylindrée	Année	Bougie	 		
				Ref CGN standard	Bougie iridium	Ref CGN iridium
R 1150 GS R21	1150	03-	BKR7EKC DCPR8EKC	496385 496383	BKR7EIX DCPR8EIX	512417 / 496403
R 1150 GS R21	1150	99-03	BKR7EKC	496385	BKR7EIX	512417
R 1150 GS R21A	1150	03-	BKR7EKC DCPR8EKC	496385 496383	BKR7EIX DCPR8EIX	512417 / 496403
R 1150 R	1150	01-03	BKR7EKC	496385	BKR7EIX	512417
R 1150 R	1150	02-06	BKR7EKC DCPR8EKC	496385	BKR7EIX DCPR8EIX	512417 / 496403
R 1150 R R21	1150	03-	BKR7EKC DCPR8EKC	496385 496383	BKR7EIX DCPR8EIX	512417 / 496403
R 1150 R R21 A	1150	03-	BKR7EKC DCPR8EKC	496385 496383	BKR7EIX DCPR8EIX	512417 / 496403
R 1150 R Rockster	1150	02-05	BKR7EKC DCPR8EKC	496385	BKR7EIX DCPR8EIX	512417 / 496403
R 1150 RS	1150	00-02	BKR7EKC	496385	BKR7EIX	512417
R 1150 RS	1150	03-04	BKR7EKC DCPR8EKC	496385	BKR7EIX DCPR8EIX	512417 / 496403
R 1150 RT	1150	01-03	BKR7EKC	496385	BKR7EIX	512417
R 1150 RT	1150	00-06	BKR7EKC	496385	BKR7EIX	512417
R 1150 RT	1150	03-06	BKR7EKC DCPR8EKC	496385	BKR7EIX DCPR8EIX	512417 / 496403
R 1150 S	1150	03-	BKR7EKC DCPR8EKC	496385 496383	BKR7EIX DCPR8EIX	512417 / 496403
R 1200 C - 259C	1200	03-09	BKR7EKC DCPR8EKC	496385	BKR7EIX DCPR8EIX	512417 / 496403
R 1200 C - 259C	1200	03	BKR7EKC	496385	BKR7EIX	512417
R 1200 C Independent - 259C	1200	00-03	BKR6EKC	512449	BKR6EIX	512421
R 1200 C Montauk - 259C	1200	02-04	BKR7EKC DCPR8EKC	496385	BKR7EIX DCPR8EIX	512417 / 496403
R 1200 CL - K30	1200	03-	BKR7EKC	496385	BKR7EIX	512417
R 1200 CL - K30	1200	03-04	BKR7EKC DCPR8EKC	496385 496383	BKR7EIX DCPR8EIX	512417 / 496403
R 1200 GS	1200	18-	LMAR8AI-10	512450	-	-
R 1200 GS - K25	1200	02-07	DCPR8EKC	496383	DCPR8EIX	496403
R 1200 GS - K25	1200	04-09	DCPR8EKC	496383	DCPR8EIX	496403
R 1200 GS - K25	1200	06-08	DCPR8EKC	496383	DCPR8EIX	496403
R 1200 GS - K25	1200	08-10	MAR8B-JDS	496393	-	-
R 1200 GS - K25	1200	10-	MAR8B-JDS	496393	-	-
R 1200 GS - K50	1200	11-	LMAR8D-J	512447	-	-
R 1200 GS 4T	1200	18-	LMAR8AI-10	512450	-	-
R 1200 GS Adventure - K25	1200	05-07	DCPR8EKC	496383	DCPR8EIX	496403
R 1200 GS Adventure - K25	1200	07-09	DCPR8EKC	496383	DCPR8EIX	496403
R 1200 GS Adventure - K25	1200	08-13	MAR8B-JDS	496393	-	-
R 1200 GS Adventure - K51	1200	12-	LMAR8D-J	512447	-	-
R 1200 GS Adventure Ref.Liquide Ø 26,5mm	1200	13-	LMAR8D-J	512447	-	-
R 1200 GS Rallye - K50	1200	12-	MAR8B-JDS	496393	-	-
R 1200 GS Ref.Liquide - K50	1200	13-	LMAR8D-J	512447	-	-



Modèle	Cylindrée	Année	Bougie	 		
				Ref CGN standard	Bougie iridium	Ref CGN iridium
R 1200 Nine T - K21	1200	14-	MAR8B-JDS	496393	-	-
R 1200 nineT - Pure, Racer, Scrambler, Urban G, S	1200	16-	MAR8B-JDS	496393	-	-
R 1200 R	1200	05-10	DCPR8EKC	496383	DCPR8EIX	496403
R 1200 R	1200	10-	MAR8B-JDS	496393	-	-
R 1200 R Ø 26,5 mm	1200	15-	LMAR8D-J	512447	-	-
R 1200 RS - K54	1200	15-	LMAR8D-J	512447	-	-
R 1200 RT	1200	18-	LMAR8AI-10	512450	-	-
R 1200 RT - K26	1200	03-09	DCPR8EKC	496383	DCPR8EIX	496403
R 1200 RT - K26	1200	09-	MAR8B-JDS	496393	-	-
R 1200 RT - K52 Ref.Liquide	1200	13-	LMAR8D-J	512447	-	-
R 1200 RT 4T	1200	18-	LMAR8AI-10	512450	-	-
R 1200 S - K29	1200	04-07	DCPR8EKC	496383	DCPR8EIX	496403
R 1200 ST - K28	1200	05-09	DCPR8EKC	496383	DCPR8EIX	496403
R 65 GS	650	-	BP6ES	490457	BPR6EIX	512415
R 80 247, 7	800	82-95	BP6ES	490457	BPR6EIX	512415
R 80 R	800	80-	BP6ES	490457	BPR6EIX	512415
R 80 RT 247, 7, 2	800	82-95	BP6ES	490457	BPR6EIX	512415
R 80 ST 247, 1	800	82-95	BP6ES	490457	BPR6EIX	512415
R 850 C 59CI, GS 259E	850	98-00	BKR7EKC	496385	BKR7EIX	512417
R 850 R 259R	850	94-02	BKR7EKC	496385	BKR7EIX	512417
R 850 RT 259T	850	96-01	BKR7EKC	496385	BKR7EIX	512417
R 850 RT R22	850	00-06	BKR7EKC	496385	BKR7EIX	512417
R 900 RT 10 SF K26 Police	900	09-	DCPR8EKC	496383	DCPR8EIX	496403
R 900 RT5 SF K26 Police	900	05-09	DCPR8EKC	496383	DCPR8EIX	496403
S 1000 R K47	1000	13-16	LMAR9D-J	512446	-	-
S 1000 R K47 107hp	1000	17-	LMAR9D-J	512446	-	-
S 1000 R K47 165hp	1000	17-	LMAR9D-J	512446	-	-
S 1000 RR HP4 K46	1000	11-	LMAR9D-J	512446	-	-
S 1000 RR K46	1000	08-13	LMAR9D-J	512446	-	-
S 1000 RR K46	1000	14-	LMAR9D-J	512446	-	-
S 1000 RR K46	1000	08-	LMAR9D-J	512446	-	-
S 1000 XR K49	1000	14-16	LMAR9D-J	512446	-	-
S 1000 XR K49	1000	15-	LMAR9D-J	512446	-	-
S 1000 XR K49	1000	17-	LMAR9D-J	512446	-	-
BOOM TRIKE						
Classic Trike Chopper, Family VW-carbu.	1600	-	B6HS	1834	BR6HIX	497114
Classic Trike Chopper, Family VW-carbu.	1600	-	B7HS	1835	BR7HIX	497113
Classic Trike Chopper, Family VW-inj.	1600	-	BP5ES-A	512453	BPR5EIX	511478
Classic Trike Low Rider VW-carbu.	1600	-	B6HS	1834	BR6HIX	497114
Classic Trike Low Rider VW-carbu.	1600	-	B7HS	1835	BR7HIX	497113
Classic Trike Low Rider VW-inj.	1600	-	BP5ES-A	512453	BPR5EIX	511478
Fighter Auto. Moteur Ford	1600	-	PTR5A-13	512454	-	-

Modèle	Cylindrée	Année	Bougie	Ref CGN standard	Bougie iridium	Ref CGN iridium
Fighter Auto. Moteur Ford	2000	-	PTR5A-13	512454	-	-
BSM (BIKER STREET MOTORS)						
FT 125	125	99-	DR8EA	198225	DR8EIX	493825
Thunderbike 4 Temps	125	99-	CR7HSA	1861	CR7HIX	496398
BUELL						
1125 CR Café Racer	1125	09-10	CR9EKB	496397	CR9EIX	381550
1125 R	1125	08-10	CR9EKB	496397	CR9EIX	381550
Café Racer, R	1125	08-	CR9EKB	496397	CR9EIX	381550
City X	984	09-	DCPR9E	213989	DCPR9EIX	512581
Cyclone	1200	97-03	DPR9EA-9	1860	DPR9EIX-9	512585
Firebolt	1200	03-	DCPR9E	213989	DCPR9EIX	512581
Lightning	1200	97-99	DPR9EA-9	1860	DPR9EIX-9	512585
Lightning	1200	99-03	DPR9EA-9	1860	DPR9EIX-9	512585
Lightning	1200	07-	DCPR9E	213989	DCPR9EIX	512581
Lightning	1200	06-07	DCPR9E	213989	DCPR9EIX	512581
Lightning	1200	07-	DCPR9E	213989	DCPR9EIX	512581
Lightning City X	1200	-	DCPR9E	213989	DCPR9EIX	512581
M2 Cyclone	1200	97-03	DCPR8E	512442	DCPR8EIX	496403
S1 Lightning	1200	96-97	DCPR8E	512442	DCPR8EIX	496403
S1 White Lightning	1200	98-09	DCPR8E	512442	DCPR8EIX	496403
S2 Thunderbolt	1200	95-96	DCPR8E	512442	DCPR8EIX	496403
S3 Thunderbolt	1200	97-10	DCPR8E	512442	DCPR8EIX	496403
Thunderbolt, Touring	1200	97-99	DPR9EA-9	1860	DPR9EIX-9	512585
Ulysse	1200	06-07	DCPR9E	213989	DCPR9EIX	512581
W White Lightning	1200	98-	DCPR9E	213989	DCPR9EIX	512581
X1 Lightning	1200	99-10	DCPR8E	512442	DCPR8EIX	496403
XB 12 R, 12 SCG, 12S TT	1200	07-10	DCPR9E	213989	DCPR9EIX	512581
XB 12 S	1200	04-07	DCPR9E	213989	DCPR9EIX	512581
XB 12 SS, X	1200	06-07	DCPR9E	213989	DCPR9EIX	512581
XB 12 XT	1200	08-10	DCPR9E	213989	DCPR9EIX	512581
XB9R	1000	01-07	DCPR9E	213989	DCPR9EIX	512581
XB-9R Firebolt, Lightning	984	02-	DPR9EA-9	1860	DPR9EIX-9	512585
XB9S	1000	03-07	DCPR9E	213989	DCPR9EIX	512581
XB-9S Firebolt, Lightning	984	02-	DPR9EA-9	1860	DPR9EIX-9	512585
XB9S, XB9SX	1000	05-07	DCPR9E	213989	DCPR9EIX	512581
XB9-SX 1000 Lightning CityX	984	05-	DCPR9E	213989	DCPR9EIX	512581
XB9-X 1000 City X	984	09-	DCPR9E	213989	DCPR9EIX	512581
BULTACO						
Alpina	250	-	BP5ES	490456	BPR5EIX	511478
Alpina, Lobito MK3, Lobito MK6	125	-	BP5ES	490456	BPR5EIX	511478
Alpina, Lobito MK6	175	-	BP5ES	490456	BPR5EIX	511478
Alpina, Matador MK9, MK10	350	-	BP5ES	490456	BPR5EIX	511478



Modèle	Cylindrée	Année	NOK		NOK	
			Bougie	Ref CGN standard	Bougie iridium	Ref CGN iridium
Astro	250	-	B9EG	1869	-	-
Astro, El Bandito MK2	360	-	B8ES	1843	BR8EIX	381507
Astro, El Bandito MK2	360	-	B9EG	1869	-	-
Campera MK2, Lobito MK7	175	-	B5ES	512591	-	-
Campera, Mercurio, Mercurio GT, Tralla	150	-	B6HS	1834	BR6HIX	497114
El Tigre, Mercurio, Metise, Senior	200	-	B8ES	1843	BR8EIX	381507
Frontera	250	-	B8ES	1843	BR8EIX	381507
Frontera	360	-	B8ES	1843	BR8EIX	381507
Frontera MK11	370	-	B8ES	1843	BR8EIX	381507
Frontera, Junior, Lobito MK7, Mercurio	125	-	B6HS	1834	BR6HIX	497114
Go Kart, Pursang MK5	200	-	B9EG	1869	-	-
Matador 250, Matador 250 SD	250	-	BP5ES	490456	BPR5EIX	511478
Matador MK2, Matador MK3	250	-	B8ES	1843	BR8EIX	381507
Matador MK4	250	-	BP6ES	490457	BPR6EIX	512415
Mercurio	175	-	B6HS	1834	BR6HIX	497114
Mercurio GT	175	-	BP5ES	490456	BPR5EIX	511478
Metralla GT	250	-	B8ES	1843	BR8EIX	381507
Metralla GTS	250	-	BP5ES	490456	BPR5EIX	511478
Metralla MK2, Metralla MK250	250	-	B8ES	1843	BR8EIX	381507
Pursang	360	-	B8ES	1843	BR8EIX	381507
Pursang	360	-	B9EG	1869	-	-
Pursang	370	-	B8ES	1843	BR8EIX	381507
Pursang	370	-	B9EG	1869	-	-
Pursang MK15	450	-	B8ES	1843	BR8EIX	381507
Pursang MK4, MK5, MK6, MK7	250	-	B8ES	1843	BR8EIX	381507
Pursang MK4, MK5, MK6, MK7	250	-	B9EG	1869	-	-
Pursang MK5	125	-	B10EG	1870	-	-
Pursang MK5, MK6	350	-	B8ES	1843	BR8EIX	381507
Pursang MK5, MK6	350	-	B9EG	1869	-	-
Pursang MK5, Sherpa MK3	175	-	B9EG	1869	-	-
Pursang MK6	125	-	B9EG	1869	-	-
Sherco	125	00-	BPR5ES	198191	BPR5EIX	511478
Sherco	200	00-	BPR5ES	198191	BPR5EIX	511478
Sherco	250	99-	BPR5ES	198191	BPR5EIX	511478
Sherco	290	00-	BPR5ES	198191	BPR5EIX	511478
Sherpa MK3	200	-	B9EG	1869	-	-
Sherpa S	125	-	B9EG	1869	-	-
Sherpa S	200	-	B7ES	1842	BR7EIX	497115
Sherpa S	250	-	B9EG	1869	-	-
Sherpa T	250	-	BP5ES	490456	BPR5EIX	511478
Sherpa T, Streaker, Tralla	125	-	B6HS	1834	BR6HIX	497114

MOTEUR

CYCLE

PNEUMATIQUE

ATELIER

ACCESSOIRES

ÉLECTRICITÉ

FILTRATION

FREINAGE

TRANSMISSION



Modèle	Cylindrée	Année	Bougie			Ref CGN iridium
				Ref CGN standard	Bougie iridium	
CAGIVA						
90	125	90-	B9ES	1844	BR9EIX	381511
900 i.e GT	900	91-	DR9EA	214048	DR9EIX	512583
900 i.e.	900	91-	DR9EA	214048	DR9EIX	512583
A8 Trail, Blues	125	-	B9ES	1844	BR9EIX	381511
Ala Blu 350	350	-	B8ES	1843	BR8EIX	381507
Ala Blu 350, Ala Verde 350	350	-	B8ES	1843	BR8EIX	381507
Ala Rossa 350, 4T	350	83-	B8ES	1843	BR8EIX	381507
Ala Verde 350	350	-	B8ES	1843	BR8EIX	381507
Alazzurra 350	350	84-	BP7HS	490460	BPR7HIX	497112
Alazzurra 650	650	-	BP7HS	490460	BPR7HIX	497112
Alazzurra 650	650	84-	BP7HS	490460	BPR7HIX	497112
Aletta Electra	125	84-	B9ES	1844	BR9EIX	381511
Aletta Oro	125	84-	B9ES	1844	BR9EIX	381511
Aletta Oro 125, S2	125	86-	B9ES	1844	BR9EIX	381511
Aletta Rossa, Dakar	125	-	B9EG	1869	-	-
Aletta, Low Rider	125	82-	B8ES	1843	BR8EIX	381507
C10	125	87-	B9ES	1844	BR9EIX	381511
Canyon 500 - 12mm	500	-	D8EA	1855	DR8EIX	493825
Canyon 600	600	96-97	-	-	BKR7EIX	512417
Canyon 600	600	98	BCP7ES	512592	BCPR7EIX	512416
Cruiser	125	87-	B9ES	1844	BR9EIX	381511
Cucciolo	125	00-	CR9EB	328861	CR9EIX	381550
Cucciolo	125	99-	CR7E	213902	CR7EIX	490469
Dakar, Elefant 2, Elefant 3	125	-	B9EG	1869	-	-
Elefant 350, Indiana 350	350	-	BP7HS	490460	BPR7HIX	497112
Elefant 750	750	94-97	DPR8EA-9	1857	DPR8EIX-9	496388
Elefant 900 AC	900	93-97	DPR9EA-9	1860	DPR9EIX-9	512585
Elefant, ie, GT	900	90-96	DPR9EA-9	1860	DPR9EIX-9	512585
Freccia C10	125	-	B9ES	1844	BR9EIX	381511
Freccia C9, C12, C12R	125	87-	B9ES	1844	BR9EIX	381511
Gran Canyon 900	900	99-	DCPR8E	512442	DCPR8EIX	496403
Indiana	650	-	BP7HS	490460	BPR7HIX	497112
Indiana	750	-	BP7HS	490460	BPR7HIX	497112
K7	125	-	-	-	BR10EIX	381617
Lucky 350	350	-	DP8EA-9	214029	DPR8EIX-9	496388
Mito	500	07-	CR8EB	384085	CR8EIX	490470
Mito 125	125	91-	BR9EG	1892	-	-
Mito 125	125	95-98	-	-	BR10EIX	381617
Mito 125	125	99-	BR9EG	1892	BR9EIX	381511
Mito E.V.	125	98-	BR9EG	1892	-	-
Mito EV 125	125	-	BR10EG	198172	-	-



Modèle	Cylindrée	Année	NOK		NOK	
			Bougie	Ref CGN standard	Bougie iridium	Ref CGN iridium
Mito MK2	125	92-	-	-	BR10EIX	381617
Mito Racing	125	-	-	-	BR10EIX	381617
Mito SP525	125	08-	BR9EG	1892	-	-
Mito, Mito E.V.	125	95-	-	-	BR10EIX	381617
MX	250	-	B9ES	1844	BR9EIX	381511
MXR	250	-	B9ES	1844	BR9EIX	381511
MXR 500	500	-	-	-	BR10EIX	381617
N 90	125	90-	B9ES	1844	BR9EIX	381511
Navigator 1000	1000	99-	CR8EK	461666	CR8EIX	490470
Navigator T	1000	00-	CR8EK	461666	CR8EIX	490470
NC, RL	250	83-	B8ES	1843	BR8EIX	381507
Nuvola	125	-	CR7E	213902	CR7EIX	490469
Passing	125	94-	BP6HS	490458	BPR6HIX	512414
Planet	125	98-03	BR9EG	1892	-	-
R, Supermotard	125	96-	B9ES	1844	BR9EIX	381511
Raptor	1000	99-	CR8EK	461666	CR8EIX	490470
Raptor 125	125	04-	BR9EG	1892	-	-
Raptor, V-Raptor	650	00-	CR8E	1862	CR8EIX	490470
River 500	500	99-	DCPR8E	496380	DCPR8EIX	496403
River 600	600	95-	BCP7ES	512592	BCPR7EIX	512416
RL, SS, SX	125	-	B8ES	1843	BR8EIX	381507
Roadster 125	125	92-	B9ES	1844	BR9EIX	381511
Roadster, Roadster 521	125	98-	BR9ES	1890	BR9EIX	381511
Roadster, Roadster 521	125	-	B9ES	1844	BR9EIX	381511
RR, RX	250	-	B9ES	1844	BR9EIX	381511
SS	250	83-	B8ES	1843	BR8EIX	381507
SST 350	350	-	B8ES	1843	BR8EIX	381507
Super City	600	95-	-	-	BKR7EIX	512417
Supercity	125	98-	BR9EG	1892	BR9EIX	381511
Supercity	125	92-	-	-	BR10EIX	381617
Supercity	125	99-	BR9EG	1892	BR9EIX	381511
SX	125	-	B8ES	1843	BR8EIX	381507
T4 350 E, R	350	86-	DP8EA-9	214029	DPR8EIX-9	496388
T4 500 E, R	450	-	DP8EA-9	214029	DPR8EIX-9	496388
Tamanaco 125	125	88-	B9ES	1844	BR9EIX	381511
Tous modèles	175	-	B8ES	1843	BR8EIX	381507
Tous modèles	200	-	B9ES	1844	BR9EIX	381511
Trial 350	350	82-	BP5ES	490456	BPR5EIX	511478
V-Raptor	1000	00-	CR8EK	461666	CR8EIX	490470
W12 350	350	93-	DPR8EA-9	1857	DPR8EIX-9	496388
W16	600	94-	-	-	BKR7EIX	512417
W16 600	600	-95	C7E	512444	CR7EIX	490469

Modèle	Cylindrée	Année	NGK		NGK	
			Bougie	Ref CGN standard	Bougie iridium	Ref CGN iridium
W16 600	600	95-	BCP7ES	512592	BCPR7EIX	512416
W8	125	91-	-	-	BR10EIX	381617
W8	125	96-97	B9ES	1844	BR9EIX	381511
W8	125	98-	BR9ES	1890	BR9EIX	381511
W8 R, Supermotard	125	96-	B9ES	1844	BR9EIX	381511
WMX	250	-	B9ES	1844	BR9EIX	381511
WMX 125	125	84-	-	-	BR9EIX	381511
WMX 125	125	85-	-	-	BR10EIX	381617
WMX 125	125	87-	-	-	BR10EIX	381617
WR, WRE125	125	02-	BR9EG	1892	BR9EIX	381511
WSXT 125	125	82-	B9EG	1869	BR9EIX	381511
X-tra Raptor 1000	1000	03-	CR8EK	461666	CR8EIX	490470
CAN-AM						
500 Sonic, Sonic MX	500	-	D8EA	1855	DR8EIX	493825
MX-4, MX-5, Qualifer	370	-	B9ES	1844	BR9EIX	381511
MX6, MX400, Qualifer	400	-	B9ES	1844	BR9EIX	381511
Qualifier 350 III	350	81-	B9ES	1844	BR9EIX	381511
Spyder	1000	08-	DCPR9E	213989	DCPR9EIX	512581
Spyder F3	1330	15-	MR7BI-8	512456	-	-
Spyder Roadster	1000	08-	DCPR9E	213989	DCPR9EIX	512581
Spyder RS	998	08-12	DCPR9E	213989	DCPR9EIX	512581
Spyder RS	998	13-	KR8BI	512455	-	-
Spyder RT	998	10-11	DCPR9E	213989	DCPR9EIX	512581
Spyder RT	998	12-13	KR8BI	512455	-	-
Spyder RT	1330	14-	MR7BI-8	512456	-	-
Spyder ST	998	13-	KR8BI	512455	-	-
Tous modèles	125	79-	B9ES	1844	BR9EIX	381511
Trials	310	83-	BP5ES	490456	BPR5EIX	511478
Trials 350	350	85-	B9ES	1844	BR9EIX	381511
CAN-AM / BOMBARDIER - SSV						
Commander 1000	1000	11-	DCPR8E	512442	DCR8EIX	512422
Commander 800	800	11-	DCPR8E	512442	DCPR8EIX	496403
CANNONDALE						
EX 400	432	01-	CR9EK	213936	CR9EIX	381550
MX 400	432	00-	CR9EK	213936	CR9EIX	381550
XC 400	432	01-	CR9EK	213936	CR9EIX	381550
CARREFOUR						
PFM	125	00-	DR8EA	198225	DR8EIX	493825
CCM						
240 CMT Trails	240	-	BP5ES	490456	BPR5EIX	511478
250 CMT Trails	250	-	BP5ES	490456	BPR5EIX	511478
250 CMX	250	82-	B8ES	1843	BR8EIX	381507



Modèle	Cylindrée	Année	Bougie	 		
				Ref CGN standard	Bougie iridium	Ref CGN iridium
310 CMT Trails	310	-	BP5ES	490456	BPR5EIX	511478
320 CMT Trails	320	-	BP5ES	490456	BPR5EIX	511478
350 CMT Trails	350	-	BP5ES	490456	BPR5EIX	511478
350 Trials	350	78-	B6ES	1841	-	-
4 Temps 560 CCM	560	-	D8EA	1855	DR8EIX	493825
404 DS, 404 E	400	03-	CR8E	1862	CR8EIX	490470
404XC-Trail	400	-	CR8E	1862	CR8EIX	490470
490 CMX	490	-	B9EG	1869	-	-
500 CMX	500	-	D8EA	1855	DR8EIX	493825
500 MTT	500	-	DR8EA	198225	DR8EIX	493825
500 MTT	500	-	D8EA	1855	DR8EIX	493825
500 MTT	500	-	DR8EA	198225	DR8EIX	493825
560 CCM	560	-	DR8EA	198225	DR8EIX	493825
560 CCM 2-T, 560 CCM 4-T	560	-	DR8EA	198225	DR8EIX	493825
604 E Sport	600	98-02	D8EA	1855	DR8EIX	493825
604 E Supermoto	600	98-02	D8EA	1855	DR8EIX	493825
604 R	600	98-02	D8EA	1855	DR8EIX	493825
604 R, 604 R30, 604 RS	600	-	DR8EA	198225	DR8EIX	493825
604 R30, RS	600	98-02	D8EA	1855	DR8EIX	493825
604 Roadster RS, 604 Trail Dual Sport	600	01-	DR8EA	198225	DR8EIX	493825
604 RS	600	98-02	D8EA	1855	DR8EIX	493825
604 Supermoto Dual Sport	600	01-	DR8EA	198225	DR8EIX	493825
640 RS	640	-	DR8EA	198225	DR8EIX	493825
640 RS Moteur Rotax	640	99-00	D8EA	1855	DR8EIX	493825
644 Moteur Suzuki	650	02-	CR10EK	213947	CR10EIX	498279
CM 36 Road Racer	350	78-	-	-	BR9EIX	381511
CMX	450	82-	-	-	BR8EIX	381507
CMX	560	-	D8EA	1855	DR8EIX	493825
CMX 500	500	82-	DR8EA	198225	DR8EIX	493825
Dual Sport Trail, Dual Supermoto	644	00-	D8EA	1855	DR8EIX	493825
FT 35	400	05-	CR8E	1862	CR8EIX	490470
Moteur Suzuki	644	02-	CR10E	512457	CR10EIX	498279
R 35	400	06-	CR8E	1862	CR8EIX	490470
R 35 Factory Big Bore Conversion	435	06-	CR8E	1862	CR8EIX	490470
R30	644	05-	CR10E	512457	CR10EIX	498279
R30 Moteur Suzuki	710	05-	CR10E	512457	CR10EIX	498279
R30 Supermotard	644	02-	D8EA	1855	DR8EIX	493825
R30 Supermotard Moteur Suzuki	650	02-	CR9EK	213936	CR9EIX	381550
SR 40	400	07-	CR8E	1862	CR8EIX	490470
CF						
Explorer W, Glory, Ride Glory, W, Wallstreet	125	-	DPR7EA-9	198282	DPR7EIX-9	512580

MOTEUR

CYCLE

PNEUMATIQUE

ATELIER



ACCESSOIRES

ÉLECTRICITÉ

FILTRATION



FREINAGE

TRANSMISSION

Modèle	Cylindrée	Année	Bougie	 		Ref CGN iridium
				Ref CGN standard	Bougie iridium	
DAELIM						
250 Roadsport	250	12-	CR9EH-9	198278	CR9EHIX-9	496391
Advance	125	95-	C8EH-9	512596	CR8EHIX-9	496404
Advance, Evolution	125	97-	CR8EH-9	198263	CR8EHIX-9	496404
Altino 125 ES	125	02-	C8EH-9	512596	CR8EHIX-9	496404
Besbi	125	08-	CR7HSA	1861	CR7HIX	496398
Classic	125	00-	CR8EH-9	198263	CR8EHIX-9	496404
Daystar	125	00-	C8EH-9	512596	CR8EHIX-9	496404
Evolution	125	97-	CR8EH-9	198263	CR8EHIX-9	496404
Evolution	125	98-	CR8EH-9	198263	CR8EHIX-9	496404
Evolution VS	125	02	C8EH-9	512596	CR8EHIX-9	496404
Fellow	125	98-99	CR8EH-9	198263	CR8EHIX-9	496404
Fellow, Fellow II	125	98-00	CR8EH-9	198263	CR8EHIX-9	496404
Freewing 125	125	05-	CR8EH-9	198263	CR8EHIX-9	496404
Freewing 125 Fi (Injection)	125	07-	CR8EH-9	198263	CR8EHIX-9	496404
History	125	04-	CR8EH-9	198263	CR8EHIX-9	496404
History 125	125	-	CR8EH-9	198263	CR8EHIX-9	496404
II DLX	125	01-	CR8EH-9	198263	CR8EHIX-9	496404
NF 125 ES 'Altino	125	03-	CR8EH-9	198263	CR8EHIX-9	496404
NS	125	08-	CR7HSA	1861	CR7HIX	496398
NS 125	125	98-00	CR8EH-9	198263	CR8EHIX-9	496404
NS 125	125	01-	CR8EH-9	198263	CR8EHIX-9	496404
NS 125	125	08-	CR7HSA	1861	CR7HIX	496398
NS 125 Trans Eagle	125	98-	CR8EH-9	198263	CR8EHIX-9	496404
NS Fellow	125	98-99	CR8EH-9	198263	CR8EHIX-9	496404
NS Fellow II	125	98-00	CR8EH-9	198263	CR8EHIX-9	496404
NS II DLX	125	01-	CR8EH-9	198263	CR8EHIX-9	496404
Otello	125	03-	CR8EH-9	198263	CR8EHIX-9	496404
Otello 125 Fi (Injection)	125	07-	CR8EH-9	198263	CR8EHIX-9	496404
Otello 125 SE	125	04-	CR8EH-9	198263	CR8EHIX-9	496404
Othello	125	98-	CR8EH-9	198263	CR8EHIX-9	496404
Roadwin	125	-	CR8EH-9	198263	CR8EHIX-9	496404
Roadwin	125	03-04	CR8EH-9	198263	CR8EHIX-9	496404
Roadwin 125 R	125	07-	CR9EH-9	198278	CR9EHIX-9	496391
S1 125 Fi	125	07-10	CR8EH-9	198263	CR8EHIX-9	496404
S1 125 Fi	125	11-16	CR8EH-9	198263	CR8EHIX-9	496404
S2 125	125	05-08	CR8EH-9	198263	CR8EHIX-9	496404
S2 125 Fi	125	08-16	CR8EH-9	198263	CR8EHIX-9	496404
S2, S2 Freewing	125	05-06	CR8EH-9	198263	CR8EHIX-9	496404
S3 125 Fi	125	11-	CR8EH-9	198263	CR8EHIX-9	496404
SL History 125	125	-	CR8EH-9	198263	CR8EHIX-9	496404
SQ 250 S2	250	05-09	DPR7EA-9	198282	DPR7EIX-9	512580





Modèle	Cylindrée	Année	Bougie			Ref CGN iridium
				Ref CGN standard	Bougie iridium	
SU 125 Delfino	125	09-13	CR7HSA	1861	CR7HIX	496398
Trans Eagle	125	98-	CR8EH-9	198263	CR8EHIX-9	496404
VC 125	125	97-	CR8EH-9	198263	CR8EHIX-9	496404
VC 125 Advance	125	95-	C8EH-9	512596	CR8EHIX-9	496404
VEE	125	-	CR8EH-9	198263	CR8EHIX-9	496404
VEE 125	125	-	CR8EH-9	198263	CR8EHIX-9	496404
VJ 125 Roadwin	125	03-04	CR8EH-9	198263	CR8EHIX-9	496404
VJF 250 Roadwin	250	10-16	CR9EH-9	198278	CR9EHIX-9	496391
VL 125	125	00-	CR8EH-9	198263	CR8EHIX-9	496404
VL 125 Daystar	125	02-03	C8EH-9	512596	CR8EHIX-9	496404
VL 125 Daystar	125	04-	CR8EH-9	198263	CR8EHIX-9	496404
VL 125 Daystar Classic	125	00-	CR8EH-9	198263	CR8EHIX-9	496404
VL 125 L Daystar	125	02-	C8EH-9	512596	CR8EHIX-9	496404
VL 250 Daystar	250	13-	CR9EH-9	198278	CR9EHIX-9	496391
VL L Daystar	125	02-	C8EH-9	512596	CR8EHIX-9	496404
VS 125	125	97-98	CR8EH-9	198263	CR8EHIX-9	496404
VS 125	125	97-	CR8EH-9	198263	CR8EHIX-9	496404
VS 125 EVO	125	99-	CR8EH-9	198263	CR8EHIX-9	496404
VT 125 EVO	125	00-	CR8EH-9	198263	CR8EHIX-9	496404
VT 125 Evolution	125	98-	C8EH-9	512596	CR8EHIX-9	496404
DAFIER						
T-8A, T-10A, T-10D, T-10E	125	-	DR8EA	198225	DR8EIX	493825
DERBI						
2002 6V	200	-	B9ES	1844	BR9EIX	381511
2002, Gran Prix, 6V	200	-	B9ES	1844	BR9EIX	381511
Boulevard 150 4 temps	150	-	CR9E	1863	CR9EIX	381550
Boulevard 4 temps	125	10-	CR7EB	450804	CR7EIX	490469
Boulevard 4 temps	125	03-	CR9E	1863	CR9EIX	381550
Boulevard 4 Temps - Piaggio ref.air	125	08-	CR7EB	450804	CR7EIX	490469
Boulevard 4 Temps AC	125	03-	CR9E	1863	CR9EIX	381550
Boulevard 4T	150	03-	CPR8E	336134	-	-
Cross City 125 TW, Senda Baja ('R)125	125	07-	D8EA	1855	DR8EIX	493825
CRS, RC	125	-	-	-	BR10EIX	381617
CRX, Enduro, RC	250	-	-	-	BR10EIX	381617
Enduro	125	-	-	-	BR9EIX	381511
GPI	250	06-	CR9EB	328861	CR9EIX	381550
GPI 125, 125 Racing	125	07-	CR8EB	384085	CR8EIX	490470
GPI 250, 250 Racing	250	07-	PMR8B	512439	-	-
GPR 125 4V	125	09-	CR8EB	384085	CR8EIX	490470
GPR Nude	125	04-	BR8ES	1889	BR8EIX	381507
GPR Racing	125	04-	BR8ES	1889	BR8EIX	381507
HDR Cabriolet	125	00-	CR7E	213902	CR7EIX	490469

Modèle	Cylindrée	Année	Bougie	 		
				Ref CGN standard	Bougie iridium	Ref CGN iridium
Karmathan	125	-	-	-	BR9EIX	381511
Mulhacen 659, Mulhacen 659 Café	660	05-	CR7E	213902	CR7EIX	490469
Mulhacen, Mulhacen Café	125	07-	CR8EB	384085	CR8EIX	490470
Nude, Racing	125	04-	BR8ES	1889	BR8EIX	381507
Rambla 250	250	08-09	PMR8B	512439	-	-
Rambla 300i	250	10-	CR8EKB	496381	CR8EIX	490470
RS125TT	125	-	-	-	BR9EIX	381511
Senda 125 Cross City	125	07-16	D8EA	1855	DR8EIX	493825
Senda Baja ('R)125	125	07-	D8EA	1855	DR8EIX	493825
Senda Cross City	125	-	CR8EB	384085	CR8EIX	490470
Senda DRD 125 R	125	09-	CR8EB	384085	CR8EIX	490470
Senda DRD 125 SM	125	09-	CR8EB	384085	CR8EIX	490470
Senda R 125	125	02-08	DPR8EA-9	1857	DPR8EIX-9	496388
Senda R 4 Temps, Senda SM	125	04-	DPR8EA-9	1857	DPR8EIX-9	496388
Senda R-Baja	125	-	D8EA	1855	DR8EIX	493825
Senda SM 125	125	02-08	DPR8EA-9	1857	DPR8EIX-9	496388
Senda SM, Senda R	125	09-	CR8EB	384085	CR8EIX	490470
Senda SM-Baja	125	-	D8EA	1855	DR8EIX	493825
Sonar 125 4 temps	125	09-11	CR7EB	450804	CR7EIX	490469
Sport Coppa, TTS9	125	-	B9ES	1844	BR9EIX	381511
Terra, Terra Adventure	125	07-	CR8EB	384085	CR8EIX	490470
TTS9	125	-	B9ES	1844	BR9EIX	381511
Turismo 250	250	-	B9ES	1844	BR9EIX	381511
TW Cross City 125	125	07-	D8EA	1855	DR8EIX	493825
Variant Sport 125	125	12-16	CR7EB	450804	CR7EIX	490469
DUCATI						
748	748	95-03	R2525-9	512459	-	-
748	748	99-	R2525-9	512459	-	-
SP5	888	93-	R2349-9	512597	-	-
Strada	888	93-	R2525-9	512459	-	-
Strada	888	94-	DR9EA	214048	DR9EIX	512583
1000 DS	1000	03-05	-	-	DCR8EIX	512422
1000 DS	1000	06-	DCPR8E	512442	DCPR8EIX	496403
1000 S2,HR	1000	85-	BPR7HS	1887	BPR7HIX	497112
1000 Sport	1000	03-	DCPR8E	512442	DCPR8EIX	496403
1000 SuperSport	1000	06-	DCPR8E	512442	DCPR8EIX	496403
1000 Supersport ie	1000	03-	DCPR8E	512442	DCPR8EIX	496403
1098, Tricolore, S Tricolore, S	1098	07-	MARIOA-J	512593	-	-
1198 R	1198	08-09	MARIOA-J	512593	-	-
1198 R	1198	09-	MARIOA-J	512593	-	-
1198 R Corse	1198	10-	MARIOA-J	512593	-	-
1198 S	1198	08-	MARIOA-J	512593	-	-





Modèle	Cylindrée	Année	NOK POWER PLUGS		NOK POWER PLUGS	
			Bougie	Ref CGN standard	Bougie iridium	Ref CGN iridium
1198 S R Corse, R Corse, SP	1198	10-	MAR10A-J	512593	-	-
400 Monster	400	-05	-	-	DCR8EIX	512422
400 Scrambler	400	-	KR8C-G	512458	-	-
600 SS	600	94-97	-	-	DCR8EIX	512422
600 Supersport	600	94-	DCPR8E	512442	DCPR8EIX	496403
620 Sport (V500AA)	620	03-04	-	-	DCR8EIX	512422
620 Sport (V501AA)	620	03-04	-	-	DCR8EIX	512422
748 Biposto	748	99-	R2525-9	512459	-	-
748 Biposto	748	95-04	-	-	DCR9EIX	512586
748 Dark	748	04-06	CR9EB	328861	CR9EIX	381550
748 R (748S)	748	99-	-	-	DCR9EIX	512586
748 R (H300AA)	748	00-04	R2349-10	512460	-	-
748 S	748	00-04	-	-	DCR9EIX	512586
748 S	748	-	R2525-9	512459	-	-
748 SP	748	95-98	R2349-10	512460	-	-
748 SP (H300AA)	748	95-03	R2525-9	512459	-	-
748 SPS	748	95-03	-	-	DCR9EIX	512586
748 SPS	748	95-03	R2525-9	512459	-	-
748 SPS	748	98-00	R2349-10	512460	-	-
750 Montjuich	750	-	BP7HS	490460	BPR7HIX	497112
750 Sport	750	-	DCPR8E	512442	DCR8EIX	512422
750 SS	750	91-	-	-	DCR8EIX	512422
750 SS	750	91-	DCPR8E	512442	DCR8EIX	512422
750 SS HF I.E.	750	-	-	-	DCR8EIX	512422
750 SS i.e.	750	98-	DCPR8E	512442	DCR8EIX	512422
800 i.e. Monster	800	03-05	DCPR8E	512442	DCR8EIX	512422
800 Sport	800	03-	-	-	DCR8EIX	512422
800 Sport	800	03-	DCPR8E	512442	DCR8EIX	512422
800 SuperSport	800	03-	-	-	DCR8EIX	512422
848 Evo	850	11-	MAR10A-J	512593	-	-
848 Evo Corse s.e.	850	12-	MAR10A-J	512593	-	-
851 S.P., II, III, IV	851	-	-	-	DR9EIX	512583
899 Panigale	899	13-	MAR9A-J	512461	-	-
900 Darmah	900	-	B6HS	1834	BR6HIX	497114
900 SL	900	91-	DPR9EA-9	1860	DPR9EIX-9	512585
900 SS	900	91-	DCPR8E	512442	DCR8EIX	512422
900 SS Final Edition	900	99-03	DPR8EA-9	1857	DPR8EIX-9	496388
900 SS i.e.	904	91-98	-	-	DCR8EIX	512422
900 Superlight	900	92-	DCPR8E	512442	DCPR8EIX	496403
900 Supersport	900	97-	DCPR8E	512442	DCR8EIX	512422
900 Supersport FE	900	97-	DCPR8E	512442	DCR8EIX	512422
907 i.e.	907	-	DCPR8E	512442	DCPR8EIX	496403



Modèle	Cylindrée	Année	Bougie	 		
				Ref CGN standard	Bougie iridium	Ref CGN iridium
916	916	94-	-	-	DCPR9EIX	512581
916 Biposto	916	94-97	-	-	DCR9EIX	512586
916 Senna	916	94-97	-	-	DCR9EIX	512586
916 SP	916	94-	R2349-10	512460	-	-
916 SPS Fogarty Replica	916	98-	R2349-10	512460	-	-
916 ST4 Sporttouring	916	98-03	-	-	DCPR9EIX	512581
916 Strada	916	94-97	-	-	DCR9EIX	512586
996 B, S	996	98-	-	-	DCR9EIX	512586
996 Biposto	996	98-	-	-	DCR9EIX	512586
996 Biposto	996	98-	-	-	DCR9EIX	512586
996 R	996	01-	R2349-10	512460	-	-
996 R	998	00-02	CR9EB	328861	CR9EIX	381550
996 S	996	00-02	-	-	DCR9EIX	512586
996 SP, SPS	996	98-	-	-	DCR9EIX	512586
996 SPS Factory	996	98-	-	-	DCR9EIX	512586
996 SPS Racing	996	99-00	R2349-10	512460	-	-
996 Strada	996	98-	-	-	DCR9EIX	512586
996 Strada Biposto	996	98-	-	-	DCR9EIX	512586
996 Strada Biposto	996	99-01	R2525-9	512459	-	-
998 Biposto, R, S	998	01-	CR9EB	328861	CR9EIX	381550
998 Matrix	998	03-	CR9EB	328861	CR9EIX	381550
998 R (H200AA)	998	01-	R2349-10	512460	-	-
Classic Sport 1000	1000	06-09	DCPR8E	512442	DCPR8EIX	496403
Desmosedici RR	989	07-	MAR10A-J	512593	-	-
Diavel 1200 ABS	1200	11-	MAR9A-J	512461	-	-
Diavel 1200 AMG ABS	1200	13-	MAR9A-J	512461	-	-
Diavel 1200 Carbon ABS	1200	11-	MAR9A-J	512461	-	-
GT 1000 Sportclassic	992	06-10	DCPR8E	512442	DCPR8EIX	496403
GT 1000 Sportclassic Touring	992	06-10	DCPR8E	512442	DCPR8EIX	496403
GT1000	992	06-	DCPR8E	512442	DCR8EIX	512422
Hypermotard	800	13-	MAR9A-J	512461	-	-
Hypermotard	821	13-	MAR9A-J	512461	-	-
Hypermotard	1078	07-	DCPR8E	496380	DCPR8EIX	496403
Hypermotard 1100	1100	07-09	DCPR8E	512442	DCPR8EIX	496403
Hypermotard 1100 EVO SP Corse Edition	1100	12-	DCPR8E	512442	DCPR8EIX	496403
Hypermotard 1100 EVO, EVO S	1100	10-	DCPR8E	512442	DCPR8EIX	496403
Hypermotard 1100, S	1100	07-09	DCPR8E	512442	DCPR8EIX	496403
Hypermotard 796	800	09-12	DCPR8E	512442	DCPR8EIX	496403
Hypermotard 939	939	16-	MAR9A-J	512461	-	-
Hypermotard 939 SP	939	16-	MAR9A-J	512461	-	-
Hyperstrada	821	13-	MAR9A-J	512461	-	-
Hyperstrada 939	939	16-	MAR9A-J	512461	-	-



Modèle	Cylindrée	Année	NOK		NOK	
			Bougie	Ref CGN standard	Bougie iridium	Ref CGN iridium
M 900 I.E.	900	99-	-	-	DCR8EIX	512422
MH 900 E	900	02-	DCPR8E	512442	DCPR8EIX	496403
MH 900 Evoluzione	900	00-	DPR8EA-9	1857	DPR8EIX-9	496388
Monster S4	916	01-03	-	-	DCR9EIX	512586
Monster 1000	1000	03-	DCPR8E	512442	DCPR8EIX	496403
Monster 1000 i.e.	992	03-	DCPR8E	512442	DCR8EIX	512422
Monster 1000 i.e.	1000	03-05	-	-	DCR8EIX	512422
Monster 1100 EVO	1100	10-	DCPR8E	512442	DCPR8EIX	496403
Monster 1100, S	1100	09-10	DCPR8E	512442	DCPR8EIX	496403
Monster 1200 R	1200	16-	MAR9A-J	512461	-	-
Monster 1200, S	1200	14-	MAR9A-J	512461	-	-
Monster 600	600	94-01	-	-	DCR8EIX	512422
Monster 600	600	94-01	DCPR8E	512442	DCR8EIX	512422
Monster 620 i.e.	620	02-06	DCPR8E	512442	DCPR8EIX	496403
Monster 695	695	06-07	DCPR8E	496380	DCPR8EIX	496403
Monster 696	696	07-	DCPR8E	512442	DCPR8EIX	496403
Monster 750	750	96-	DCPR8E	512442	DCR8EIX	512422
Monster 750	750	97-02	-	-	DCR8EIX	512422
Monster 796	800	10-	DCPR8E	512442	DCPR8EIX	496403
Monster 800 i.e.	800	03-	-	-	DCR8EIX	512422
Monster 800 i.e. S	800	03-	DCPR8E	512442	DCPR8EIX	496403
Monster 800 Sport	800	03-	DCPR8E	512442	DCPR8EIX	496403
Monster 800 Supersport ie	800	03-	DCPR8E	512442	DCPR8EIX	496403
Monster 821, 821 Dark	821	14-	MAR9A-J	512461	-	-
Monster 900 S ie	900	99-	DCPR8E	512442	DCPR8EIX	496403
Monster 900 Spezial	900	00-	DPR8EA-9	1857	DPR8EIX-9	496388
Monster 996 S4R	996	03-06	-	-	DCR9EIX	512586
Monster Dark	600	94-01	DCPR8E	512442	DCR8EIX	512422
Monster Dark DD (M403AC)	620	04-	DCPR8E	512442	DCPR8EIX	496403
Monster Dark DD (M408AA)	620	04-	DCPR8E	512442	DCPR8EIX	496403
Monster Dark DD (M409AA)	620	04-	DCPR8E	512442	DCPR8EIX	496403
Monster Dark SD (M403AC)	620	04-	DCPR8E	512442	DCPR8EIX	496403
Monster Dark SD (M408AA)	620	04-	DCPR8E	512442	DCPR8EIX	496403
Monster Dark SD (M409AA)	620	04-	DCPR8E	512442	DCPR8EIX	496403
Monster S	600	94-01	DCPR8E	512442	DCR8EIX	512422
Monster S2R	800	05-07	-	-	DCR8EIX	512422
Monster S2R	992	05-	DCPR8E	512442	DCR8EIX	512422
Monster S2R 1000	1000	06-08	DCPR8E	512442	DCPR8EIX	496403
Monster S2R Dark 1000	992	05-	DCPR8E	512442	DCR8EIX	512422
Monster S4R	998	07	CR9EB	328861	CR9EIX	381550
Monster S4R	998	08-	MAR10A-J	512593	-	-
Monster S4RS	998	06-07	CR9E	1863	CR9EIX	381550

Modèle	Cylindrée	Année	Bougie	 		
				Ref CGN standard	Bougie iridium	Ref CGN iridium
Monster S4RS	998	08-	MAR10A-J	512593	-	-
Monster Standard	800	04-	DCPR8E	512442	DCPR8EIX	496403
Monster Standard	1000	04-	DCPR8E	496380	DCPR8EIX	496403
Monstro 600, 600 Dark	600	-98	DCPR8E	512442	DCPR8EIX	496403
Monstro 900	900	-99	DCPR8E	512442	DCPR8EIX	496403
Multistrada 1000	1000	02-05	-	-	DCR8EIX	512422
Multistrada 1000	1000	04-05	-	-	DCR8EIX	512422
Multistrada 1000	1000	06-	DCPR8E	512442	DCPR8EIX	496403
Multistrada 1000	1000	06-	DCPR8E	512442	DCPR8EIX	496403
Multistrada 1000 DS	1000	04-05	-	-	DCR8EIX	512422
Multistrada 1000 DS (A100AB)	1000	06-	DCPR8E	512442	DCPR8EIX	496403
Multistrada 1000 S	1000	04-05	-	-	DCR8EIX	512422
Multistrada 1000 S (A100AB)	1000	06-	DCPR8E	512442	DCPR8EIX	496403
Multistrada 1100	1100	08-10	DCPR8E	512442	DCPR8EIX	496403
Multistrada 1100 S	1100	08-10	DCPR8E	512442	DCPR8EIX	496403
Multistrada 1200	1200	10-12	MAR9A-J	512461	-	-
Multistrada 1200	1200	13-14	MAR10A-J	512593	-	-
Multistrada 1200 Enduro	1200	16-	MAR9A-J	512461	-	-
Multistrada 1200 S	1200	10-12	MAR9A-J	512461	-	-
Multistrada 1200 S GT	1200	13-14	MAR10A-J	512593	-	-
Multistrada 1260	1260	18-	MAR9A-J	512461	-	-
Multistrada 620 (A103AA)	620	05-07	DCPR8E	512442	DCPR8EIX	496403
Multistrada 620 (A104AA)	620	05-07	DCPR8E	512442	DCPR8EIX	496403
Multistrada 950	950	16-	MAR9A-J	512461	-	-
Multistrada DS 1000	992	04-	DCPR8E	512442	DCPR8EIX	496403
Multistrada Pikes Peak, S, S D'Jair	1260	18-	MAR9A-J	512461	-	-
Panigale 1199	1200	12-14	MAR9A-J	512461	-	-
Panigale 1199 R	1200	13-14	MAR9A-J	512461	-	-
Panigale 1199 R	1200	15-	MAR9A-J	512461	-	-
Panigale 1199 S	1200	12-14	MAR9A-J	512461	-	-
Panigale 1199 S Tricolore	1200	12-13	MAR9A-J	512461	-	-
Panigale 1299	1299	15-	MAR9A-J	512461	-	-
Panigale 1299 R Final Edition	1299	18-	MAR10A-J	512593	-	-
Panigale 1299 S	1299	15-	MAR9A-J	512461	-	-
Panigale 1299 S Anniversario	1299	17-	MAR9A-J	512461	-	-
Panigale 959	959	16-	MAR9A-J	512461	-	-
Panigale 959	959	16-	MAR9A-J	512461	-	-
Panigale V4, V4 S, V4 Speciale	1100	17-	LMDR10A-JS	512462	-	-
Paul Smart 1000 Limited Edition	992	05-06	DCPR8E	512442	DCR8EIX	512422
S2R 800	800	05-08	DCPR8E	512442	DCR8EIX	512422
Scrambler 800	800	15-	DCPR8E	512442	DCR8EIX	512422
Sport 1000	992	05-	DCPR8E	512442	DCR8EIX	512422





Modèle	Cylindrée	Année	Bougie	 		
				Ref CGN standard	Bougie iridium	Ref CGN iridium
Sport 1000 Naked	1000	07-	DCPR8E	512442	DCPR8EIX	496403
Sport 1000 S	992	06-10	DCPR8E	512442	DCPR8EIX	496403
Sport 1000 Sportclassic (Paul Smart)	1000	06	DCPR8E	512442	DCPR8EIX	496403
SS 1000 DS	992	03-06	DCPR8E	512442	DCR8EIX	512422
SS 800	800	03-	DCPR8E	512442	DCR8EIX	512422
ST2 Sporttouring	944	97-03	-	-	DCR8EIX	512422
ST3 1000	1000	04-08	CR9EB	328861	CR9EIX	381550
ST3 1000 Sporttouring	992	04-	CR9EB	328861	CR9EIX	381550
ST4S	996	00-	-	-	DCR9EIX	512586
ST4S 996	996	03-05	-	-	DCR9EIX	512586
ST4S 996 ABS	996	03-05	-	-	DCPR9EIX	512581
Streetfighter	850	12-	MAR10A-J	512593	-	-
Streetfighter, S	1100	09-	MAR10A-J	512593	-	-
Superleggera 1199	1200	14	MAR9A-J	512461	-	-
Supersport 939	939	17-	MAR9A-J	512461	-	-
Supersport S 939	939	17-	MAR9A-J	512461	-	-
Xdiavel 1260, S	1260	16-	MAR9A-J	512461	-	-
FANTIC						
Caballero, Cross, RSX	125	-	B9EG	1869	-	-
Enduro 175	175	-	B8EG	198244	-	-
Professional	300	-	B8EG	198244	-	-
Professional, Trial, Competicion	125	-	B7HS	1835	BR7HIX	497113
Section	250	95-97	BCP7ES	512592	BCPR7EIX	512416
Trial 125	125	-	B6HS	1834	BR6HIX	497114
Trial 200	160	-	BP7HS	490460	BPR7HIX	497112
Trial 200	200	-	B7HS	1835	BR7HIX	497113
Trial 240	240	-	B6HS	1834	BR6HIX	497114
Trial 301 Competicion	250	-	BP5ES	490456	BPR5EIX	511478
Trial 301, 305, 307	250	-	B8ES	1843	BR8EIX	381507
Trial Coach, Trial K-Roo	250	-	B8ES	1843	BR8EIX	381507
TX	250	-	B8EG	198244	-	-
TX	260	-	B8EG	198244	-	-
TX	330	-	B8EG	198244	-	-
TX 160	160	-	B8EG	198244	-	-
GAS GAS						
12	125	94-	BP5ES	490456	BPR5EIX	511478
12 Contact	125	95-	BP5ES	490456	BPR5EIX	511478
16 Contact	160	95-	BP5ES	490456	BPR5EIX	511478
2 Temps	125	04-	BR9EG	1892	-	-
250 MC	250	04-	BR8EG	214162	-	-
Contact	320	95-	BP5ES	490456	BPR5EIX	511478
Contact 250	250	15-	BPR5ES	198191	BPR5EIX	511478

Modèle	Cylindrée	Année	NOG		NOG	
			Bougie	Ref CGN standard	Bougie iridium	Ref CGN iridium
Contact JT 25	238	94-	BP5ES	490456	BPR5EIX	511478
Contact T 12	125	94-	BP5ES	490456	BPR5EIX	511478
Contact T 16	143	94-	BP5ES	490456	BPR5EIX	511478
Cross	125	-	-	-	BR10EIX	381617
Cross 250	250	-	BR8EG	214162	-	-
Cross TT 125	125	-	-	-	BR10EIX	381617
Delta 25 GT	250	-	BP5ES	490456	BPR5EIX	511478
Delta 32 GT, Trial 327	330	-	BP5ES	490456	BPR5EIX	511478
EC	300	04-	BR8EG	214162	-	-
EC 125	125	97-	B9EG	1869	-	-
EC 125	125	04-	BR9EG	1892	-	-
EC 200	200	99-	-	-	BR10EIX	381617
EC 200	200	04-	BR8EG	214162	-	-
EC 200 Racing	200	11-	BR8EG	214162	BR8EIX	381507
EC 250	250	97-	B8EG	198244	-	-
EC 250 2 temps	250	04-	BR8EG	214162	-	-
EC 250 Racing (Incl.Replica 2T)	250	10-	BR8EG	214162	-	-
EC 250 SIX (Incl.Replica 2T)	250	10-	BR8EG	214162	-	-
EC 300 (Italie)	300	99-	-	-	BR10EIX	381617
EC 300 F 4T	300	13-	CR9E	1863	CR9EIX	381550
EC 300 Racing (Incl.Replica 2T)	300	10-	BR8EG	214162	-	-
EC 300 SIX (Incl.Replica 2T)	300	10-	BR8EG	214162	-	-
EC 4 Temps	450	05-	CR8E	1862	CR8EIX	490470
EC 400 FSE	400	02-	CR8E	1862	CR8EIX	490470
EC 450 FSE	450	-	CR8E	1862	CR8EIX	490470
EC 515 FSR	515	08-10	CR8E	1862	CR8EIX	490470
ECF 250 4T	250	10-11	CR8E	1862	CR8EIX	490470
ECF 250 4T	250	12-	CR9E	1863	CR9EIX	381550
ECF 250 SIX 4T	250	10-11	CR8E	1862	CR8EIX	490470
ECF 250 SIX 4T	250	12-	CR9E	1863	CR9EIX	381550
Enducross	125	95-	-	-	BR10EIX	381617
Enducross	125	97-	BR9EG	1892	-	-
Enducross	125	94-	-	-	BR10EIX	381617
Enducross	300	99-	BR8EG	214162	-	-
Enducross 250	250	-	-	-	BR10EIX	381617
Enducross 250	250	-	-	-	BR10EIX	381617
Enducross TT 125	125	95-	-	-	BR10EIX	381617
Enduro	125	02-	BR8EG	214162	-	-
Enduro	250	02	BR8EG	214162	-	-
Enduro	300	02-	BR8EG	214162	-	-
Enduro 200	200	02-	BR8EG	214162	-	-
Endurocross	200	99-	-	-	BR10EIX	381617



Modèle	Cylindrée	Année	NOK		NOK	
			Bougie	Ref CGN standard	Bougie iridium	Ref CGN iridium
Endurocross	200	02-	BR8EG	214162	-	-
FSE 450	450	03-	CR8E	1862	CR8EIX	490470
GT 125	125	94-	BP5ES	490456	BPR5EIX	511478
GT 25	240	94-	BP5ES	490456	BPR5EIX	511478
GT16 (Ref.liquide)	160	-	BP5ES	490456	BPR5EIX	511478
Halley 125	125	09-	BR9ES	1890	BR9EIX	381511
Halley 450 R	450	08-	CR8E	1862	CR8EIX	490470
Husqvarna (TM)	125	-	B10EG	1870	-	-
Husqvarna (TM)	250	-	B10EG	1870	-	-
JT 125 Contact	125	95-	BP5ES	490456	BPR5EIX	511478
JT 320 Contact	320	95-	BP5ES	490456	BPR5EIX	511478
JTR	370	-	BPR5ES	198191	BPR5EIX	511478
MC 125	125	04-	BR9EG	1892	-	-
MC 250	250	04-	BR8EG	214162	-	-
Normada 500	500	-	D8EA	1855	DR8EIX	493825
Pampera	250	97-03	BPR6ES	198187	BPR6EIX	512415
Pampera	250	04-	BPR5ES	198191	BPR5EIX	511478
Pampera	320	-	BPR6ES	198187	BPR6EIX	512415
Pampera	370	97-	BPR6ES	198187	BPR6EIX	512415
Pampera	450	07	CR8E	1862	CR8EIX	490470
Pampera 125	125	97-	BPR6ES	198187	BPR6EIX	512415
Pampera 200	200	-	BPR6ES	198187	BPR6EIX	512415
Pampera 4 Temps	125	10-	BPR6ES	198187	BPR6EIX	512415
Pampera 400	400	06-	CR8E	1862	CR8EIX	490470
Piri-A 6 Magnum	250	-	BP5ES	490456	BPR5EIX	511478
Piri-A 6 Magnum, Trial 250 (eau + air)	250	-	BP5ES	490456	BPR5EIX	511478
Pro	125	04-	BPR5ES	198191	BPR5EIX	511478
Pro	250	01-	BPR5ES	198191	BPR5EIX	511478
Pro	280	04-	BPR5ES	198191	BPR5EIX	511478
Racing, SIX	125	10-	BR9EG	1892	-	-
Racing, SIX (Incl. Replica) 2T	300	10-	BR8EG	214162	-	-
Raga Replica	250	11-	BPR5ES	198191	BPR5EIX	511478
SM	400	-	CR8E	1862	CR8EIX	490470
SM	450	04-	CR8E	1862	CR8EIX	490470
SM	515	08-10	CR8E	1862	CR8EIX	490470
SM 450 FSE	450	-	CR8E	1862	CR8EIX	490470
SM Halley 450	450	09-	CR8E	1862	CR8EIX	490470
Supermotard	125	-	BR9EG	1892	-	-
Supermotard	250	-	BR8EG	214162	-	-
Trial	125	99-	BPR5ES	198191	BPR5EIX	511478
Trial	270	99-	BPR5ES	198191	BPR5EIX	511478
Trial	280	00-	BPR5ES	198191	BPR5EIX	511478

Modèle	Cylindrée	Année	Bougie	 		
				Ref CGN standard	Bougie iridium	Ref CGN iridium
Trial	300	-	BP5ES	490456	BPR5EIX	511478
Trial 125	125	-	BP5ES	490456	BPR5EIX	511478
Trial 250 (Ref.Liquide&Air)	250	-	BP5ES	490456	BPR5EIX	511478
Trial Halley PXC 325	330	-	B9ES	1844	BR9EIX	381511
TT 125	125	-	BR8EG	214162	-	-
TT 200	200	-	BR8EG	214162	-	-
TT 250	250	-	BR8EG	214162	-	-
TT 300	300	-	BR8EG	214162	-	-
TX 125	125	97-98	BPR5ES	198191	BPR5EIX	511478
TX 200	200	97-98	BPR5ES	198191	BPR5EIX	511478
TX 250	250	97-98	BPR5ES	198191	BPR5EIX	511478
TX 320	320	97-98	BPR5ES	198191	BPR5EIX	511478
TX Randonne	125	11-	CR6HSA	213898	CR6HIX	512424
TX,TXT 321	321	99-	BP5ES	490456	BPR5EIX	511478
TXT 125	125	99-	BPR5ES	198191	BPR5EIX	511478
TXT 125 Pro	125	04-	BPR5ES	198191	BPR5EIX	511478
TXT 240 Trial	200	99-	BPR5ES	198191	BPR5EIX	511478
TXT 249 Trial	249	99-	BPR5ES	198191	BPR5EIX	511478
TXT 250	250	-	BPR5ES	198191	BPR5EIX	511478
TXT 250 Pro	250	01-	BPR5ES	198191	BPR5EIX	511478
TXT 250 Raga Replica	250	11-	BPR5ES	198191	BPR5EIX	511478
TXT 280	272	00-	BP5ES	490456	BPR5EIX	511478
TXT 280	280	-	BPR5ES	198191	BPR5EIX	511478
TXT 280 Pro	280	04-	BPR5ES	198191	BPR5EIX	511478
TXT 280 Racing	280	11-	BPR5ES	198191	BPR5EIX	511478
TXT 280 Raga Replica	280	11-	BPR5ES	198191	BPR5EIX	511478
TXT 280 Trial	280	00-	BPR5ES	198191	BPR5EIX	511478
TXT 300	300	-	BPR5ES	198191	BPR5EIX	511478
TXT 300	300	11-	BPR5ES	198191	BPR5EIX	511478
TXT 300 Pro	300	11-	BPR5ES	198191	BPR5EIX	511478
TXT 300 Racing	300	11-	BPR5ES	198191	BPR5EIX	511478
TXT 300 Raga Replica	300	11-	BPR5ES	198191	BPR5EIX	511478
TXT 321, Trial	321	99-	BPR5ES	198191	BPR5EIX	511478
GENERIC						
Explorer Race 125	125	-	CR8E	1862	CR8EIX	490470
Explorer Race, Race, Ride Sarrio, Soho	125	-	CR8E	1862	CR8EIX	490470
Generic Race, Soho, Race, Zion	125	-	CR8E	1862	CR8EIX	490470
Generic Soho 150	150	-	CR8E	1862	CR8EIX	490470
Generic XOR 125	125	-	CR7HSA	1861	CR7HIX	496398
Ride Sarrio 125	125	-	CR8E	1862	CR8EIX	490470
Soho 150	150	-	CR8E	1862	CR8EIX	490470
XOR 125	125	-	CR7HSA	1861	CR7HIX	496398
XOR 125 Williams	125	08-	CR7HSA	1861	CR7HIX	496398



Modèle	Cylindrée	Année	Bougie	Ref CGN standard	Bougie iridium	Ref CGN iridium
GILERA						
800	800	07-	CR7EKB	450805	CR7EIX	490469
Cross Competition	125	-	-	-	BR10EIX	381617
E1	125	-	-	-	BR10EIX	381617
Endurance	125	-	B9ES	1844	BR9EIX	381511
Enduro	125	-	-	-	BR10EIX	381617
FB Nordwest	600	92-	D8EA	1855	DR8EIX	493825
SS Supersport	600	02-	CR9E	1863	CR9EIX	381550
SV Regolarità	125	-	-	-	BR10EIX	381617
125 5V Regolarità	125	-	-	-	BR10EIX	381617
250 C3	250	-	-	-	BR10EIX	381617
250 KK	250	-	B9ES	1844	BR9EIX	381511
250 KZ	250	-	B9ES	1844	BR9EIX	381511
2T	125	06-	BR8ES	1889	BR8EIX	381507
4 Temps	125	00-	CR9EB	328861	CR9EIX	381550
Apache	125	-	B10EG	1870	-	-
Arizona	125	-	B9EG	1869	-	-
C	600	92-	D8EA	1855	DR8EIX	493825
C1, C3	125	-	-	-	BR10EIX	381617
Cougar	125	01-	DPR8EA-9	1857	DPR8EIX-9	496388
Crono, Freestyle 2T	125	-	B10EG	1870	-	-
Dakota (4-Stroke)	350	-	DPR8EA-9	1857	DPR8EIX-9	496388
Dakota 350	350	-	DPR8EA-9	1857	DPR8EIX-9	496388
Dakota 350	350	-	DP9EA-9	512463	DPR9EIX-9	512585
Dakota 350 ER	350	-	DP9EA-9	512463	DPR9EIX-9	512585
Dakota 500	500	87-	DP9EA-9	512463	DPR9EIX-9	512585
DANN 180 Leader	180	00-	CR9EB	328861	CR9EIX	381550
DNA 125	125	00-	CR8EB	384085	CR8EIX	490470
DNA 180 4T	180	00-	CR8EB	384085	CR8EIX	490470
DNA 180 4T	180	01-	CR9EB	328861	CR9EIX	381550
E1 Competition	125	-	-	-	BR10EIX	381617
Fuoco 500	500	07-	CR7EKB	450805	CR7EIX	490469
Fuoco ie	500	07-	CR7EKB	450805	CR7EIX	490469
GFR 125	125	-	-	-	BR10EIX	381617
GFR 125	125	-	-	-	BR10EIX	381617
GP 800	840	07-	CR7EKB	450805	CR7EIX	490469
HX 125	125	-	-	-	BR10EIX	381617
HX 250	250	-	-	-	BR10EIX	381617
Leader 4 Temps	180	00-	CR9EB	328861	CR9EIX	381550
Moteur Yamaha 4T	125	07-	BR8ES	1889	BR8EIX	381507
Nexus	300	09-	CR8EKB	496381	CR8EIX	490470
Nexus 125	125	07-	CR8EKB	496381	CR8EIX	490470
Nexus 125	125	07-	CR8EB	384085	CR8EIX	490470



Modèle	Cylindrée	Année	NGK		NGK	
			Bougie	Ref CGN standard	Bougie iridium	Ref CGN iridium
Nexus 300	300	09-	CR8EKB	496381	CR8EIX	490470
Nexus 300 SP	250	06-	CR8EB	384085	CR8EIX	490470
Nexus 500	500	04-	CR7EKB	450805	CR7EIX	490469
Nexus ie	125	07-	CR8EB	384085	CR8EIX	490470
Nexus ie	250	07-	PMR8B	512439	-	-
Nexus ie - Mot. Piaggio	500	04-05	CR7EKB	450805	CR7EIX	490469
Nexus SP	250	06-	CR8EB	384085	CR8EIX	490470
Nordcape	600	92-	D8EA	1855	DR8EIX	493825
Nordwest	600	-	DCPR8E	496380	DCPR8EIX	496403
Nordwest 600	560	91-95	DPR9EA-9	1860	DPR9EIX-9	512585
Nordwest 600	600	-	DCPR9E	213989	DCPR9EIX	512581
NX 250 LC	250	-	-	-	BR10EIX	381617
RIS	125	89-	B9EG	1869	-	-
RC 125 Rally	125	-	B9ES	1844	BR9EIX	381511
RC 600 4T	560	-	DPR8EA-9	1857	DPR8EIX-9	496388
RC 600 C	600	92-	D8EA	1855	DR8EIX	493825
Runner	125	97-00	B9EG	1869	-	-
Runner 125	125	-	CR9E	1863	CR9EIX	381550
Runner 150	150	98-	BR9ES	1890	BR9EIX	381511
Runner 2 Temps	125	97-00	B9EG	1869	-	-
Runner 200 VXR	200	02-08	CR8EB	384085	CR8EIX	490470
Runner FX125	125	97-	B9ES	1844	BR9EIX	381511
Runner FX125 2T	125	97-	BR9ES	1890	BR9EIX	381511
Runner FXR 180 2T	180	98-01	BR9ES	1890	BR9EIX	381511
Runner RST, ST	125	05-	CR8EB	384085	CR8EIX	490470
Runner ST 200	200	08-	CR8EB	384085	CR8EIX	490470
Runner ST 200	200	08-	CPR8E	336134	CR8EIX	490470
Runner VX	125	06-	CR8EB	384085	CR8EIX	490470
Runner VX 4 Temps	125	01-	CR9EB	328861	CR9EIX	381550
Runner VXR	180	01-	CR9EB	328861	CR9EIX	381550
Runner VXR 4 Temps	180	01-	CR9EB	328861	CR9EIX	381550
Runner VXR 4 Temps	200	02-08	CPR8E	336134	-	-
RV 250 NGR	250	-	B9ES	1844	BR9EIX	381511
Saturno	500	-	DP9EA-9	512463	DPR9EIX-9	512585
Saturno (4-Stroke)	350	90-	DPR8EA-9	1857	DPR8EIX-9	496388
SC 2T	125	06-	BR8ES	1889	BR8EIX	381507
SC 4T Moteur Yamaha	125	07-	BR8ES	1889	BR8EIX	381507
Supersport	600	02-	CR9E	1863	CR9EIX	381550
TG1, GRI	125	-	B7ES	1842	BR7EIX	497115
Top Rally RC	125	90-	B10EG	1870	-	-
Typhoon	125	95-	B9ES	1844	BR9EIX	381511
XR 2	125	89-	B9EG	1869	-	-



Modèle	Cylindrée	Année	NOK		NOK	
			Bougie	Ref CGN standard	Bougie iridium	Ref CGN iridium
XRI 125	125	-	B9EG	1869	-	-
XRT 350	350	88-	DP9EA-9	512463	DPR9EIX-9	512585
HARLEY DAVIDSON						
1586 'Dyna Fat Bob	1586	08-	DCPR8E	512442	DCPR8EIX	496403
1586 'Dyna Street Bob	1586	07-10	DCPR8E	512442	DCPR8EIX	496403
1586 'Softail Custom	1586	08-	DCPR8E	512442	DCPR8EIX	496403
1586 'Softail Deluxe	1586	07-10	DCPR8E	512442	DCPR8EIX	496403
1586 'Softail Deuce	1586	07	DCPR8E	512442	DCPR8EIX	496403
1586 'Softail Fatboy	1586	07-10	DCPR8E	512442	DCPR8EIX	496403
1586 'Softail Heritage Classic	1586	07-10	DCPR8E	512442	DCPR8EIX	496403
1586 Softail Springer Classic	1586	07	DCPR8E	512442	DCPR8EIX	496403
1586 Softail Standard	1586	07	DCPR8E	512442	DCPR8EIX	496403
1586 Touring Road Glide	1586	07-10	DCPR8E	512442	DCPR8EIX	496403
1586 Touring Road King	1586	07-10	DCPR8E	512442	DCPR8EIX	496403
1586 Touring Street Glide	1586	07-10	DCPR8E	512442	DCPR8EIX	496403
1586 Touring Ultra Classic E-Glide	1586	07-10	DCPR8E	512442	DCPR8EIX	496403
1690 E-Glide Ultra Limited	1690	10-	DCPR8E	512442	DCPR8EIX	496403
1800 CVO, CVO-LTRSE, Fat Bob, Street Bob	1800	09-	DCPR8E	512442	DCPR8EIX	496403
Blackline	1584	11-	DCPR8E	512442	DCPR8EIX	496403
CVO Fat Bob	1584	09-	DCPR8E	512442	DCPR8EIX	496403
Dyna Wide Glide	1584	09-	DCPR8E	512442	DCPR8EIX	496403
FKDWG Dyna Wide Glide	1340	-	BPR5ES	198191	BPR5EIX	511478
FL TC 88	1450	98-07	DCPR7E	496387	DCPR7EIX	512584
FL V-2 Evolution	1340	84-00	BPR5ES-11	512467	BPR5EIX-11	512425
FLHR 1340 Electra Glide Road King	1340	94-	BPR5ES	198191	BPR5EIX	511478
FLHR 1340 Electra Glide Road King inj.	1340	96-	BPR5ES-11	512467	BPR5EIX-11	512425
FLHR 1450 Electra Glide Road King	1450	99-03	DCPR7E	496387	DCPR7EIX	512584
FLHR 1584 Road King	1584	07-	DCPR7E	496387	DCPR7EIX	512584
FLHRC 1584 Road King Classic	1584	07-	DCPR7E	496387	DCPR7EIX	512584
FLHRCi 1340 Road King Classic inj.	1340	96-	BPR5ES-11	512467	BPR5EIX-11	512425
FLHRCi 1340 Road King Classic side car	1340	-	BPR5ES	198191	BPR5EIX	511478
FLHRCi 1450 Road King Classic side car	1450	99-03	DCPR7E	496387	DCPR7EIX	512584
FLHRCi 1450 Electra Glide Road King Classic inj.	1450	99-03	DCPR7E	496387	DCPR7EIX	512584
FLHRS 1584 Road King Custom	1584	07-	DCPR7E	496387	DCPR7EIX	512584
FLHT 1340 Electra Glide Standard	1340	-	BPR5ES	198191	BPR5EIX	511478
FLHT 1450 Electra Glide Standard	1450	99-03	DCPR7E	496387	DCPR7EIX	512584
FLHT 1584 Electra Glide Standard	1584	07-	DCPR7E	496387	DCPR7EIX	512584
FLHT 1586 Electra Glide Standard	1586	07-10	DCPR8E	512442	DCPR8EIX	496403
FLHTC 1340 Electra Glide Classic	1340	-	BPR5ES	198191	BPR5EIX	511478
FLHTCi 1340 Electra Glide Classic inj.	1340	96-	BPR5ES-11	512467	BPR5EIX-11	512425
FLHTCU 1340 Electra Glide Ultra Classic	1340	-	BPR5ES	198191	BPR5EIX	511478
FLHTCU 1584 Ultra Classic Electra Glide	1584	07-	DCPR7E	496387	DCPR7EIX	512584

Modèle	Cylindrée	Année	Bougie	 		
				Ref CGN standard	Bougie iridium	Ref CGN iridium
FLHTCUI 1340 Electra Glide Ultra Classic Inj.	1340	96-	BPR5ES-11	512467	BPR5EIX-11	512425
FLHTCUI 1450 Electra Glide Ultra Classic Inj.	1450	99-03	DCPR7E	496387	DCPR7EIX	512584
FLHX 1584 Street Glide	1584	07-	DCPR7E	496387	DCPR7EIX	512584
FLSTC 1340 Heritage Softail Classic	1340	-	BPR5ES	198191	BPR5EIX	511478
FLSTC 1450 Héritage Softail Classic	1450	99-03	DCPR7E	496387	DCPR7EIX	512584
FLSTC 1584 Heritage Softail	1584	07-	DCPR7E	496387	DCPR7EIX	512584
FLSTCi 1450 Héritage Softail Classic inj.	1450	99-03	DCPR7E	496387	DCPR7EIX	512584
FLSTF 1340 Fat Boy	1340	-	BPR5ES	198191	BPR5EIX	511478
FLSTF 1584 Fat Boy	1584	07-	DCPR7E	496387	DCPR7EIX	512584
FLSTN 1584 Softail Deluxe	1584	07-	DCPR7E	496387	DCPR7EIX	512584
FLSTS 1340 Heritage Softail Springer	1340	-	BPR5ES	198191	BPR5EIX	511478
FLSTS 1450 Fat Boy	1450	99-03	DCPR7E	496387	DCPR7EIX	512584
FLSTSB 1584 Cross Bones	1584	07-	DCPR8E	512442	DCPR8EIX	496403
FLSTSB 1586 Cross Bones	1586	08-	DCPR8E	512442	DCPR8EIX	496403
FLSTSC 1584 Softail Springer Classic	1584	07-	DCPR7E	496387	DCPR7EIX	512584
FLSTSi 1450 Fat Boy inj.	1450	99-03	DCPR7E	496387	DCPR7EIX	512584
FX TC 88	1450	98-07	DCPR7E	496387	DCPR7EIX	512584
FX V-2 Evolution	1340	84-00	BPR5ES-11	512467	BPR5EIX-11	512425
FXD 1340 Dyna Super Glide	1340	-	BPR5ES	198191	BPR5EIX	511478
FXD 1450 Dyna Super Glide	1450	99-03	DCPR7E	496387	DCPR7EIX	512584
FXDB 1584 Dyna Street	1584	07-	DCPR7E	496387	DCPR7EIX	512584
FXDC 1584 Dyna Super Glide Custom	1584	07-	DCPR7E	496387	DCPR7EIX	512584
FXDC 1586 Dyna Super Glide Custom	1586	07-10	DCPR8E	512442	DCPR8EIX	496403
FXDL 1340 Dyna Low Rider	1340	-	BPR5ES	198191	BPR5EIX	511478
FXDL 1450 Dyna Low Rider	1450	99-03	DCPR7E	496387	DCPR7EIX	512584
FXDL 1584 Dyna Low Rider	1584	07-	DCPR7E	496387	DCPR7EIX	512584
FXDL 1586 Dyna Low Rider	1586	07-09	DCPR8E	512442	DCPR8EIX	496403
FXDS 'Conv Dyna Convertible	1340	-	BPR5ES	198191	BPR5EIX	511478
FXDWG 1450 Dyna Wide Glide	1450	99-03	DCPR7E	496387	DCPR7EIX	512584
FXDWG 1584 Dyna Wide Glide	1584	07-	DCPR7E	496387	DCPR7EIX	512584
FXDWG 1586 Dyna Wide Glide	1586	07-10	DCPR8E	512442	DCPR8EIX	496403
FXDX 1450 Dyna Super Glide Sport	1450	99-03	DCPR7E	496387	DCPR7EIX	512584
FXDXT 1450 Dyna Super Glide Touring Sport	1450	99-03	DCPR7E	496387	DCPR7EIX	512584
FXE, FXSB 1340 Shovel Head	1340	84-	ZGR5C	512468	-	-
FXSB 1340 Shovel Head	1340	84-	ZGR5C	512468	-	-
FXST 1340 Softail Custom	1340	-	BPR5ES	198191	BPR5EIX	511478
FXST 1450 Softail	1450	99-03	DCPR7E	496387	DCPR7EIX	512584
FXSTB 1450 Night Train	1450	99-03	DCPR7E	496387	DCPR7EIX	512584
FXSTB 1584 Night Train	1584	07-	DCPR7E	496387	DCPR7EIX	512584
FXSTB 1586 Night Train	1586	07-09	DCPR8E	512442	DCPR8EIX	496403
FXSTC 1584 Softail Custom	1584	07-	DCPR7E	496387	DCPR7EIX	512584
FXSTD 1450 Softail Deuce	1450	99-03	DCPR7E	496387	DCPR7EIX	512584



Modèle	Cylindrée	Année	Bougie	 		
				Ref CGN standard	Bougie iridium	Ref CGN iridium
FXSTDi 1450 Softail Deuce inj.	1450	99-03	DCPR7E	496387	DCPR7EIX	512584
FXSTS 1340 Softail Springer	1340	-	BPR5ES	198191	BPR5EIX	511478
FXSTS 1450 Softail Springer	1450	99-03	DCPR7E	496387	DCPR7EIX	512584
FXWG 1340 Shovel Head	1340	84-	ZGR5C	512468	-	-
Softail Rocker ©	1584	08-	DCPR8E	512442	DCPR8EIX	496403
Sportster 1200 Custom	1200	04-	DCPR8E	512442	DCPR8EIX	496403
Sportster 1200 Nightster	1200	08-	DCPR8E	512442	DCPR8EIX	496403
Sportster 883	883	95-03	DPR7EA-9	198282	DPR7EIX-9	512580
Sportster 883 Iron	883	09-	DCPR7EA-9	512464	DCPR7EIX	512584
Sportster 883 Low	883	04-	DCPR7EA-9	512464	DCPR7EIX	512584
Sportster 883 R	883	02-03	DPR7EA-9	198282	DPR7EIX-9	512580
Sportster Custom 53	883	98-03	DPR7EA-9	198282	DPR7EIX-9	512580
Sportster Custom 53	883	04-05	DCPR7EA-9	512464	DCPR7EIX	512584
Tous modèles	883	85-	DCPR7E	496387	DCPR7EIX	512584
Twin Cam 96B Models	1584	09-	DCPR8E	512442	DCPR8EIX	496403
TXSTSB 1340 Bad Boy	1340	-	BPR5ES	198191	BPR5EIX	511478
VRSC 1130 Night Rod	1130	02-	DCPR8E	512442	DCPR8EIX	496403
VRSC 1130 Street Rod	1130	02-	DCPR8E	512442	DCPR8EIX	496403
VRSC 1130 V-Rod	1130	02-09	DCPR8E	512442	DCPR8EIX	496403
VRSC Night Rod Special	1250	08-	DCPR8E	512442	DCPR8EIX	496403
VRSC V-Rod	1250	08-	DCPR8E	512442	DCPR8EIX	496403
VRSC V-Rod 10th Anniversary	1250	10-	DCPR8E	512442	DCPR8EIX	496403
VRSC V-Rod Muscle	1250	10-	DCPR8E	512442	DCPR8EIX	496403
VRSCA 1130 Night-Rod	1130	06-	DCPR9E	213989	DCPR9EIX	512581
VRSCA 1130 V-Rod	1130	02-	DPR9EA-9	1860	DPR9EIX-9	512585
VRSCDX 1130 Night Rod Special	1130	07-	DCPR7E	496387	DCPR7EIX	512584
VRSC E Screamin' Eagle V-Rod	1250	04-	DCPR9E	213989	DCPR9EIX	512581
VRSCX 1130 V-Rod	1130	07-	DCPR7E	496387	DCPR7EIX	512584
XL 1200 C Sportster	1200	07-	DCPR7E	496387	DCPR7EIX	512584
XL 1200 C Sportster Custom	1200	96-	DCPR7E	496387	DCPR7EIX	512584
XL 1200 C Sportster Custom	1200	07-	DCPR7E	496387	DCPR7EIX	512584
XL 1200 L Sportster	1200	07-	DCPR7E	496387	DCPR7EIX	512584
XL 1200 L Sportster Low	1200	07-	DCPR7E	496387	DCPR7EIX	512584
XL 1200 R Sportster	1200	07-	DCPR7E	496387	DCPR7EIX	512584
XL 1200 S Sportster Sport	1200	96-	DCPR7E	496387	DCPR7EIX	512584
XLCH, XLCR, XLH, XLS 1000	1000	78-	B-6L	512465	-	-
XLCH, XLH 1000	1000	79-	BPR6HS-10	512466	BPR6HIX	512414
XLH 1200 Sportster	1200	92-99	DCPR7E	496387	DCPR7EIX	512584
XR 1200	1200	08-09	DCPR8E	512442	DCPR8EIX	496403
XR 1200	1200	07-08	DCPR7E	496387	DCPR7EIX	512584
XR 1200	1200	08-	DCPR8E	512442	DCPR8EIX	496403

MOTEUR

CYCLE

PNEUMATIQUE

ATELIER



ACCESSOIRES

ÉLECTRICITÉ

FILTRATION

FREINAGE

TRANSMISSION

Modèle	Cylindrée	Année	Bougie	 		
				Ref CGN standard	Bougie iridium	Ref CGN iridium
XR 1200 X	1200	10-	DCPR8E	512442	DCPR8EIX	496403
XR 1200 X	1200	10-	DCPR8E	512442	DCPR8EIX	496403
HONDA						
ANF 125 Innova	125	07-	CPR6EA-9	512474	CPR6EAIX-9S	512427
CA 125 Rebel	125	97-00	CR6HSA	213898	CR6HIX	512424
CA 125 Rebel - S>Y	125	95-96	CR6HSA	213898	CR6HIX	512424
CB 1000 R	1000	08-	IMR9E-9HES	512482	-	-
CB 1000 RA	1000	08-	IMR9E-9HES	512482	-	-
CB 1100	1100	99-	-	-	CR8EHIX-9	496404
CB 1100	1100	10-	LMAR8A-9S	512491	-	-
CB 1100	1100	13-16	LMAR8A-9S	512491	-	-
CB 1100 EX	1100	14-	LMAR8A-9S	512491	-	-
CB 1100 R	1100	10-	LMAR8A-9S	512491	-	-
CB 1100 SF X-II - Y/1	1100	99-	-	-	CR8EHIX-9	496404
CB 1100 SF X-II Eleven	1100	00-03	-	-	CR8EHIX-9	496404
CB 125 F	125	15-	CPR7EA-9	496389	CPR7EAIX-9	512587
CB 125 R	125	18-	CPR7EA-9	496389	CPR7EAIX-9	512587
CB 1300 - 5	1300	05-05	DPR8EA-9	1857	DPR8EIX-9	496388
CB 1300 A - 5>9	1300	05-09	DPR8EA-9	1857	DPR8EIX-9	496388
CB 1300 DCV X4	1300	97-03	DPR9EA-9	1860	DPR9EIX-9	512585
CB 1300 F - 3>4	1300	03-04	DPR8EA-9	1857	DPR8EIX-9	496388
CB 1300 F Super Four - 3	1300	03-	DPR9EA-9	1860	DPR9EIX-9	512585
CB 1300 SA - 5	1300	05-	DPR8EA-9	1857	DPR8EIX-9	496388
CB 1300 SA Super Four ABS - 5	1300	05-	DPR8EA-9	1857	DPR8EIX-9	496388
CB 1300 Super Touring - A	1300	10-	DPR9EA-9	1860	DPR9EIX-9	512585
CB 250	250	96-98	CR6HSA	213898	CR6HIX	512424
CB 500	500	96-03	CR8EH-9	198263	CR8EHIX-9	496404
CB 500 Cup	500	98-99	CR8EH-9	198263	CR8EHIX-9	496404
CB 500 F / X	500	13-	CPR8EA-9	496384	CPR8EAIX-9	506203
CB 500 S Sport - W>Y	500	98-03	CR8EH-9	198263	CR8EHIX-9	496404
CB 600 F Hornet	600	02-06	CR9EH-9	198278	CR9EHIX-9	496391
CB 600 F Hornet	600	07-	CR9EH-9	198278	CR9EHIX-9	496391
CB 600 F Hornet - W/X/Y/1	600	98-02	CR9EH-9	198278	CR9EHIX-9	496391
CB 600 RR	600	09-	IMR9E-9HES	512482	-	-
CB 650 F	650	14-16	CR9EH-9	198278	CR9EHIX-9	496391
CB 650 F	650	17-	CR9EH-9	198278	CR9EHIX-9	496391
CB 900 F Hornet - E/D	900	02-06	CR8EH-9	198263	CR8EHIX-9	496404
CBF 1000	1000	06-10	CR8EH-9	198263	CR8EHIX-9	496404
CBF 1000 A	1000	06-	CR8EH-9	198263	CR8EHIX-9	496404
CBF 1000 F	1000	10-10	IMR8C-9HES	512487	-	-
CBF 1000 FA	1000	10-	IMR8C-9HES	512487	-	-



Modèle	Cylindrée	Année	Bougie	NOK		
				Ref CGN standard	Bougie iridium	Ref CGN iridium
CBF 1000 Limited Edition	1000	09-09	CR8EH-9	198263	CR8EHIX-9	496404
CBF 125 M	125	09-	CPR7EA-9	496389	CPR7EAIX-9	512587
CBF 150	150	14-	CPR8EA-9	496384	CPR8EAIX-9	506203
CBF 250	250	04-06	CR8EH-9S	512475	-	-
CBF 250	250	06-	CR8EH-9	198263	CR8EHIX-9	496404
CBF 500	500	04-08	CR8EH-9S	512475	-	-
CBF 500 N / NA	500	04-06	CR8EH-9S	512475	-	-
CBF 600 N / S	600	04-07	CR9EH-9	198278	CR9EHIX-9	496391
CBF 600 N / S	600	08-10	CR8EH-9	198263	CR8EHIX-9	496404
CBR 1000 RR	1000	07-	IMR9C-9H	496406	-	-
CBR 1000 RR - AB>2F / AB>3F	1000	11-	IMR9E-9HES	512482	-	-
CBR 1000 RR Fireblade	1000	04-07	IMR9C-9HES	496407	-	-
CBR 1000 RR Fireblade	1000	08-16	IMR9E-9HES	512482	-	-
CBR 1000 RR Repsol	1000	04-	IMR9C-9HES	496407	-	-
CBR 1100 XX Super Blackbird	1100	01-01	IMR9A-9H	512604	-	-
CBR 1100 XX Super Blackbird	1100	02-02	IMR9C-9H	496406	-	-
CBR 1100 XX Super Blackbird - 1	1100	01-08	IMR9C-9H	496406	-	-
CBR 1100 XX Super Blackbird - V>Y	1100	97-00	-	-	CR9EHIX-9	496391
CBR 125 R	125	04-06	CR9E	1863	CR9EIX	381550
CBR 125 R	125	07-10	CR8E	1862	CR8EIX	490470
CBR 125 RR	125	03-	CR8E	1862	CR8EIX	490470
CBR 125 RW - B>F	125	11-	CR8E	1862	CR8EIX	490470
CBR 250 R	250	11-	SIMR8A9	512599	-	-
CBR 250 RB - 2-F/3F	250	11-	SIMR8A9	512599	-	-
CBR 500 R	500	13-	CPR8EA-9	496384	CPR8EAIX-9	506203
CBR 600 F	600	95-00	CR9EH-9	198278	CR9EHIX-9	496391
CBR 600 F	600	01-04	IMR9A-9H	512604	-	-
CBR 600 F	600	05-07	IMR9C-9H	496406	-	-
CBR 600 F	600	11-13	CR9EH-9	198278	CR9EHIX-9	496391
CBR 600 FS	600	01-01	IMR9A-9H	512604	-	-
CBR 600 FS	600	02-02	IMR9C-9H	496406	-	-
CBR 600 Hannspree	600	08-	IMR9C-9H	496406	-	-
CBR 600 RR	600	03-04	IMR9C-9H	496406	-	-
CBR 600 RR	600	05-10	IMR9C-9HES	496407	-	-
CBR 600 RR ABS	600	09-	IMR9E-9HES	512482	-	-
CBR 600 RR ABS - AB>F/2F/3F	600	11-	IMR9C-9HES	496407	-	-
CBR 650 FA	650	14-	CR9EH-9	198278	CR9EHIX-9	496391
CBR 900	900	04-	IMR9C-9HES	496407	-	-
CBR 900 RR Fireblade - E/D	900	02-03	IMR9C-9H	496406	-	-
CBR 900 RR Fireblade - N>X	900	96-99	CR9EH-9	198278	CR9EHIX-9	496391

MOTEUR

CYCLE

PNEUMATIQUE

ATELIER



ACCESSOIRES

ÉLECTRICITÉ

FILTRATION



FREINAGE

TRANSMISSION

Modèle	Cylindrée	Année	Bougie	 		
				Ref CGN standard	Bougie iridium	Ref CGN iridium
CBR 900 RR Fireblade - Y	900	00-01	IMR9A-9H	512604	-	-
CBX 250 Twister	250	00-02	CR8EH-9S	512475	-	-
CG 125	125	98-99	DPR8EA-9	1857	DPR8EIX-9	496388
CH 125 IT Spacy	125	96-99	DPR7EA-9	198282	DPR7EIX-9	512580
CH 125 Spacy	125	97-	DPR7EA-9	198282	DPR7EIX-9	512580
CH 250 Spacy	250	96-96	DPR7EA-9	198282	DPR7EIX-9	512580
CLR 125 Cityfly	125	98-00	DPR8EA-9	1857	DPR8EIX-9	496388
CLR 125 CityFly - X/Y	125	98-	DPR8EA-9	1857	DPR8EIX-9	496388
CMX 250 C Rebel	250	96-99	CR6HSA	213898	CR6HIX	512424
CMX 500 Rebel	500	17-	CPR8EA-9	496384	CPR8EAIX-9	506203
Cota 4RT (Montesa)	250	09-	CR6EH-9	512476	-	-
CR 125 R	125	05-	BR9EG	1892	-	-
CR 125 R Cadre Alu - W/X/Y/1	125	97-	BR9EG	1892	-	-
CR 125 R -ED	125	01-	BR9EG	1892	-	-
CR 250 R - 2T	250	05-	BR9EG	1892	-	-
CR 250 R - ED	250	01-	BR8EG	214162	-	-
CR 250 RK5	250	05-	BR9EG-N-8	512477	-	-
CRF 1000 A / D Africa Twin	1000	17-	SILMA-R8A9S	512488	-	-
CRF 1000 AG Africa Twin ABS	1000	16-16	SILMA-R8A9S	512488	-	-
CRF 1000 AH Africa Twin	1000	17-17	SILMA-R8A9S	512488	-	-
CRF 1000 DG Africa Twin DCT	1000	16-16	SILMA-R8A9S	512488	-	-
CRF 1000 DH Africa Twin ABS	1000	17-17	SILMA-R8A9S	512488	-	-
CRF 1000 G Africa Twin	1000	16-16	SILMA-R8A9S	512488	-	-
CRF 1000 L Africa Twin	1000	16-	SILMA-R8A9S	512488	-	-
CRF 125 F	125	14-	CPR6EA-9	512474	CPR6EAIX-9S	512427
CRF 150 F	150	06-	CPR8EA-9	496384	CPR8EAIX-9	506203
CRF 150 R / R2	150	07-	CR8EH-9	198263	CR8EHIX-9	496404
CRF 150 RB	150	08-10	CR8EH-9	198263	CR8EHIX-9	496404
CRF 230 F	230	08-	DPR8EA-9	1857	DPR8EIX-9	496388
CRF 250 L	250	12-	SIMR8A9	512599	-	-
CRF 250 M	250	13-	SIMR8A9	512599	-	-
CRF 250 R	250	04-04	IMR9C-9H	496406	-	-
CRF 250 R	250	05-08	RO409B-8	512600	-	-
CRF 250 R	250	09-10	RO451B-8	512601	-	-
CRF 250 X	250	04-06	IMR9C-9H	496406	-	-
CRF 250 X	250	07-	RO409B-8	512600	-	-
CRF 260 L - D/E/F	260	13-15	SIMR8A9	512599	-	-
CRF 260 M - E/F	260	13-15	SIMR8A9	512599	-	-



Modèle	Cylindrée	Année	NOK		NOK	
			Bougie	Ref CGN standard	Bougie iridium	Ref CGN iridium
CRF 450 - 4T	450	05-	IFR9H11	512478	-	-
CRF 450 - 4T	450	09-	SILMA-R9A9S	512479	-	-
CRF 450 R	450	08-	SILMA-R9A9S	512479	-	-
CRF 450 R	450	08-	SILMA-R10A9S	512480	-	-
CRF 450 R - ED	450	02-08	IFR8H11	512481	-	-
CRF 450 X	450	05-08	IFR8H11	512481	-	-
CRS 450 R2/ R3	450	02-	IFR9H11	512478	-	-
CTX 1300	1300	14-	CR8EH-9	198263	CR8EHIX-9	496404
Dylan 125	125	02-	CR8EH-9	198263	CR8EHIX-9	496404
Dylan 150	150	02-	CR8EH-9	198263	CR8EHIX-9	496404
FES 125 Pantheon 2T - W/X/Y/1	125	98-	BR8ES	1889	BR8EIX	381507
FES 125 Pantheon 4T	125	03-	CR8EH-9	198263	CR8EHIX-9	496404
FES 125 Silver Wing	125	07-	CR8EH-9	198263	CR8EHIX-9	496404
FES 125 Silver Wing ABS - AB>F	125	11-	CR8EH-9	198263	CR8EHIX-9	496404
FES 150 Pantheon	150	05-11	CR8EH-9	198263	CR8EHIX-9	496404
FES 250 Foresight	250	98-	DPR7EA-9	198282	DPR7EIX-9	512580
FES 250 Foresight - W/X/Y	250	97-	DPR7EA-9	198282	DPR7EIX-9	512580
FES 600 Silver Wing	600	01-	CR8EH-9	198263	CR8EHIX-9	496404
FJS 400 'Silverwing	400	06-	CR8EH-9	198263	CR8EHIX-9	496404
FJS Silver Wing	600	11-	IMR9C-9HES	496407	-	-
FJS Silver Wing ABS	600	03-	CR8EH-9	198263	CR8EHIX-9	496404
FMX 650	650	05-07	DPR8EA-9	1857	DPR8EIX-9	496388
FX 650 Vigor	650	99-00	DPR8EA-9	1857	DPR8EIX-9	496388
GL 1500 F6C Valkyrie - V>1	1500	96-03	DPR7EA-9	198282	DPR7EIX-9	512580
GL 1800 A Goldwing - 1>5	1800	01-05	BKR6E-11	496386	BKR6EIX-11	512588
GL 1800 Goldwing	1800	06-	BKR6E-11	496386	BKR6EIX-11	512588
GL 1800 Goldwing	1800	12-	BKR7E-11	512494	BKR7EIX-11	512430
GL 1800 Goldwing	1800	18-	CR6HSB-9	512495	-	-
GL 1800 Goldwing - 6>7	1800	06-	BKR6E-11	496386	BKR6EIX-11	512588
MSX 125	125	13-	CPR6EA-9	512474	CPR6EAIX-9S	512427
NC 700 S/ X/ Integra	670	12-	IFR6G-11K	512484	-	-
NC 700 SA/ SD	700	12-	IFR6G-11K	512484	-	-
NC 700 XA/ XD	700	11-	IFR6G-11K	512484	-	-
NC 750	750	14-	IFR6G-11K	512484	-	-
NC 750	750	16-	IFR6G-11K	512484	-	-
NC 750 S/ X/ Integra	745	14-	IFR6G-11K	512484	-	-
NES 125	125	00-	CR8EH-9	198263	CR8EHIX-9	496404
NES 125 ES	125	01-	CR8EH-9	198263	CR8EHIX-9	496404
NES 125 Y	125	01-	CR8EH-9	198263	CR8EHIX-9	496404
NM 4 Vultus	745	14-	IFR6G-11K	512484	-	-

Modèle	Cylindrée	Année	Bougie	 		
				Ref CGN standard	Bougie iridium	Ref CGN iridium
NSA 700 DN-01	680	08-10	CPR8EA-9	496384	CPR8EAIX-9	506203
NSA 700 DN-01	680	11-	SIMR8A9	512599	-	-
NSR 125 F/R	125	97-03	BR9ECS	214196	BR9ECSIX	512428
NSS 250 Forza	250	05-07	DPR7EA-9	198282	DPR7EIX-9	512580
NSS 250 Forza ABS	250	08-	LMAR8A-9	496405	-	-
NSS 250 Jazz	250	02-	DPR7EA-9	198282	DPR7EIX-9	512580
NSS 300	300	11-	LMAR8A-9	496405	-	-
NSS 300 Forza	300	13-	LMAR8A-9	496405	-	-
NSS Forza 125 AD ABS - F	125	15-16	SILMAR8C9	500398	-	-
NSS Forza 125 AD ABS - H	125	17-	SILMAR8C9	500398	-	-
NSS Forza X / EX	250	09-	LMAR8A-9	496405	-	-
NT 650 V CBS Deauville - E/D	650	02-05	DPR8EA-9	1857	DPR8EIX-9	496388
NT 650 V Deauville - W/X/Y/1	650	98-01	DPR8EA-9	1857	DPR8EIX-9	496388
NT 700 V Deauville	680	06-09	CPR8EA-9	496384	CPR8EAIX-9	506203
NT 700 V Deauville	680	10-	CPR8EA-9	496384	CPR8EAIX-9	506203
NX 650 Dominator	650	95-00	DPR8EA-9	1857	DPR8EIX-9	496388
PCX 125	125	10-11	CPR7EA-9	496389	CPR7EAIX-9	512587
PCX 125 Auto.	125	12-	MR8C-9N	512473	-	-
PS 125 i	125	06-	CR8EH-9	198263	CR8EHIX-9	496404
PS 150 i	150	06-	CR8EH-9	198263	CR8EHIX-9	496404
RS 125 R	125	01-	R7376-10	512598	-	-
RS 250 R	250	01-	R7282-105	512602	-	-
SES 125 Dylan	125	02-	CR8EH-9	198263	CR8EHIX-9	496404
SH 125	125	17-	MR7G-9E	505589	-	-
SH 125 - B-F/Inj.	125	11-	CR8EH-9	198263	CR8EHIX-9	496404
SH 125 i	125	13-	CPR7EA-9	496389	CPR7EAIX-9	512587
SH 125 i / i Sport / i Special	125	05-12	CR8EH-9	198263	CR8EHIX-9	496404
SH 125 Mode	125	14-	CPR7EA-9	496389	CPR7EAIX-9	512587
SH 125 Scoopy	125	01-	CR8EH-9	198263	CR8EHIX-9	496404
SH 150	150	17-	MR7G-9E	505589	-	-
SH 150 i / i Sport / i Special	150	06-	CR8EH-9	198263	CR8EHIX-9	496404
SH 300 i	300	07-	LMAR8A-9	496405	-	-
SH 300 i - AB>F	300	11-	LMAR8A-9	496405	-	-
SH 300 i / i Sport / i ABS	300	07-10	LMAR8A-9	496405	-	-
SLR 650 - V/W	650	97-98	DPR8EA-9	1857	DPR8EIX-9	496388
ST 1300 A Pan European ABS - 2>	1300	02-	CR7EH-9	496392	-	-
ST 1300 Pan European - 2>4	1300	02-04	CR8EH-9	198263	CR8EHIX-9	496404
S-Wing 125	125	07-	CR8EH-9	198263	CR8EHIX-9	496404
S-Wing 150 / 150 ABS	150	07-	CR8EH-9	198263	CR8EHIX-9	496404
SW-T 400	400	09-	CR8EH-9	198263	CR8EHIX-9	496404
VFR 1200 / X Crosstourer	1200	12-	IMR8E-9HES	512492	-	-
VFR 1200 F ABS / F DCT	1200	10-	IMR9E-9HES	512482	-	-



Modèle	Cylindrée	Année	Bougie		
				Ref CGN standard	Ref CGN iridium
VFR 1200 V4 / V4 Tourer	1200	10-	IMR9E-9HES	512482	-
VFR 800	800	02-10	IMR9B-9H	512486	-
VFR 800 A	800	02-	IMR9B-9H	512486	-
VFR 800 F - W	800	97-01	CR9EH-9	198278	CR9EHIX-9
VFR 800 Fi - X>Y	800	97-01	CR9EH-9	198278	CR9EHIX-9
VFR 800 Fi V4 VTEC	800	01-	IMR9B-9H	512486	-
VFR 800 VTEC	800	13-	IMR9B-9H	512486	-
VFR 800 X - B	800	11-	IMR9D-9H	512485	-
VFR 800 XAB Crossrunner	782	12-	IMR9D-9H	512485	-
VT 1100 C2 Shadow Ace - T>Y	1100	95-00	DPR7EA-9	198282	DPR7EIX-9
VT 1100 C3 Shadow Aero - W>X	1100	98-00	DPR7EA-9	198282	DPR7EIX-9
VT 125 C Shadow	125	99-00	CR8EH-9	198263	CR8EHIX-9
VT 125 C Shadow	125	01-08	CR8EH-9	198263	CR8EHIX-9
VT 1300 CX - A	1300	10-	DCPR6E	512493	DCPR6EIX
VT 1300 CXA ABS - A	1300	10-	DCPR6E	512493	DCPR6EIX
VT 750 C Shadow	750	04-09	DPR7EA-9	198282	DPR7EIX-9
VT 750 C Shadow - V>Y	750	97-00	DPR8EA-9	1857	DPR8EIX-9
VT 750 C2 Ace Spirit	750	97-02	DPR8EA-9	1857	DPR8EIX-9
VT 750 C2 Shadow - X/Y	750	99-	DPR8EA-9	1857	DPR8EIX-9
VT 750 C2 Shadow Spirit	750	07-09	DPR7EA-9	198282	DPR7EIX-9
VT 750 C2B Shadow Black Spirit	750	10-	DPR8EA-9	1857	DPR8EIX-9
VT 750 C2S Shadow	750	10-	DPR8EA-9	1857	DPR8EIX-9
VT 750 CS Shadow	750	10-	DPR7EA-9	198282	DPR7EIX-9
VT 750 DC Black Window	750	00-03	DPR8EA-9	1857	DPR8EIX-9
VT 750 S	750	10-	DPR7EA-9	198282	DPR7EIX-9
VT 750 Shadow RS	750	10-	DPR7EA-9	198282	DPR7EIX-9
VTR 1000 F Fire Storm - V/W/X/Y/1	1000	97-06	-	-	DPR9EIX-9
VTR 1000 SP-1 - Y/1	1000	00-01	FR9BI-11	512489	-
VTR 1000 SP-2 - E/D	1000	02-06	IFR9H11	512478	-
VTX 1300 S	1300	03-07	DCPR6E	512493	DCPR6EIX
VTX 1800 C	1800	01-08	IFR6L11	512496	-
X-ADV 750	750	17-	IFR6G-11K	512484	-
XL 1000 V Varadero	1000	99-02	-	-	DPR8EIX-9
XL 1000 V Varadero	1000	03-07	IJR8B9	512490	-
XL 1000 V Varadero - 3/4/5/6/7	1000	03-	IJR8B9	512490	-
XL 1000 V Varadero - X/Y/1/2	1000	99-	-	-	DPR8EIX-9
XL 1000 VA Varadero	1000	04-	IJR8B9	512490	-
XL 1000 VA Varadero	1000	08-	IJR8B9	512490	-
XL 125 V Varadero	125	01-07	CR8EH-9	198263	CR8EHIX-9
XL 125 V Varadero	125	08-	CR8EH-9	198263	CR8EHIX-9
XL 125 VB-3E Varadéro De Luxe	125	11-	CR8EH-9	198263	CR8EHIX-9
XL 125 VB-EU Varadéro 125	125	11-	CR8EH-9	198263	CR8EHIX-9

Modèle	Cylindrée	Année	Bougie	 		
				Ref CGN standard	Bougie iridium	Ref CGN iridium
XL 600 V Transalp	600	97-00	DPR8EA-9	1857	DPR8EIX-9	496388
XL 650 V Transalp	650	00-07	DPR8EA-9	1857	DPR8EIX-9	496388
XL 700 V Transalp	680	08-	CPR8EA-9	496384	CPR8EAIX-9	506203
XLR 125 R	125	98-99	DPR8EA-9	1857	DPR8EIX-9	496388
XLR 125 R - W/X	125	97-99	DPR8EA-9	1857	DPR8EIX-9	496388
XLV 125 Varadero	125	01-	CR8EH-9	198263	CR8EHIX-9	496404
XR 125 L	125	03-06	DPR8EA-9	1857	DPR8EIX-9	496388
XR 250 R - T>Y	250	96-	CR9EH-9	198278	CR9EHIX-9	496391
XR 400 R - T>1	400	96-04	DPR8Z	512603	-	-
XR 400 R Monnier	400	99-	DPR8Z	512603	-	-
XR 650 R	650	00-07	BKR8E-11	512483	-	-
HONDA - SSV						
Pioneer 1000	1000	16-	SILMA-R7A9S	512498	-	-
SXS Pioneer 500	-	15-	BKR5E-11	512605	BKR5EIX-11	512431
SXS Pioneer 700	675	14	BKR5E-11	512605	BKR5EIX-11	512431
SXS Pioneer 700	675	15-	CPR6EB-9	512497	-	-
HRD						
Cabriolet Trail & Super Motard	125	99-	CR9EB	328861	CR9EIX	381550
HUSABERG						
Enduro Rallye	650	99-	DCPR8E	512442	DCPR8EIX	496403
FC 400	400	97-99	C8E	512606	CR8EIX	490470
FC 400	400	03-	-	-	DCPR8EIX	496403
FC 470, 6	470	00-02	DCPR8E	512442	DCPR8EIX	496403
FC 499 MX	499	95-99	C8E	512606	CR8EIX	490470
FC 501	501	95-99	C8E	512606	CR8EIX	490470
FC 550	550	03-	-	-	DCPR8EIX	496403
FC 550, 4	550	00-	DCPR8E	512442	DCPR8EIX	496403
FC 550, 6	550	00-	DCPR8E	512442	DCPR8EIX	496403
FC 600	600	92-99	C8E	512606	CR8EIX	490470
FE 250	250	13-	CR9EKB	496397	CR9EIX	381550
FE 250	250	14-	LMAR9AI-10	512499	-	-
FE 350	350	91-99	C8E	512606	CR8EIX	490470
FE 350	350	13-	LMAR9AI-8	512607	-	-
FE 390	390	10-	LKAR8AI-9	512500	-	-
FE 400	400	97-99	C8E	512606	CR8EIX	490470
FE 400 E	400	00-02	DCPR8E	512442	DCPR8EIX	496403
FE 450	450	03-08	-	-	DCPR8EIX	496403
FE 450	565	09-	LKAR8AI-9	512500	-	-
FE 450 E	450	00-08	DCPR8E	512442	DCPR8EIX	496403
FE 450 FE	450	09-	LKAR8AI-9	512500	-	-
FE 500	500	91-99	C8E	512606	CR8EIX	490470
FE 501	501	03-07	-	-	DCPR8EIX	496403



Modèle	Cylindrée	Année	Bougie	NOK		
				Ref CGN standard	Ref CGN iridium	
FE 501	501	08-	DCPR8E	512442	DCPR8EIX 496403	
FE 501	501	13-	LKAR8AI-9	512500	- -	
FE 501	501	93-99	C8E	512606	CR8EIX 490470	
FE 501E	500	00-	DCPR8E	512442	DCPR8EIX 496403	
FE 501E	501	93-99	C8E	512606	CR8EIX 490470	
FE 550 E	550	00-	DCPR8E	512442	DCPR8EIX 496403	
FE 570	560	09-	LKAR8AI-9	512500	- -	
FE 600	600	92-99	C8E	512606	CR8EIX 490470	
FE 600 E	600	98-99	C8E	512606	CR8EIX 490470	
FE 650	650	03-07	-	-	DCPR8EIX 496403	
FE 650 E	650	08-	DCPR8E	512442	DCPR8EIX 496403	
FE 650 E	650	00-	DCPR8E	512442	DCPR8EIX 496403	
FE 650 E	650	03-	-	-	DCPR8EIX 496403	
FS 400 C	400	00-02	DCPR8E	512442	DCPR8EIX 496403	
FS 400 E	400	00-02	DCPR8E	512442	DCPR8EIX 496403	
FS 550 E	550	00-	DCPR8E	512442	DCPR8EIX 496403	
FS 570	565	10-	LKAR8AI-9	512500	- -	
FS 650 C	650	00-	DCPR8E	512442	DCPR8EIX 496403	
FS 650 C	650	00-	DCPR8E	512442	DCPR8EIX 496403	
FS 650 E	650	00-	DCPR8E	512442	DCPR8EIX 496403	
FS 650 E	650	00-	DCPR8E	512442	DCPR8EIX 496403	
FX 400	400	99-	DCPR8E	512442	DCPR8EIX 496403	
FX 400 E	400	-99	C8E	512606	CR8EIX 490470	
FX 470 E	470	00-02	DCPR8E	512442	DCPR8EIX 496403	
FX 501	501	99-	DCPR8E	512442	DCPR8EIX 496403	
FX 501 E	501	97-99	C8E	512606	CR8EIX 490470	
FX 600	600	97-99	C8E	512606	CR8EIX 490470	
FX 600 E	600	97-99	C8E	512606	CR8EIX 490470	
FX 650 E	650	00-	DCPR8E	512442	DCPR8EIX 496403	
MC 350	350	-99	C8E	512606	CR8EIX 490470	
MC 501	500	-99	C8E	512606	CR8EIX 490470	
MC 600	600	-99	C8E	512606	CR8EIX 490470	
SM 400	400	99-	DCPR8E	512442	DCPR8EIX 496403	
SM 501	501	99-	DCPR8E	512442	DCPR8EIX 496403	
SM 650	650	99-	DCPR8E	512442	DCPR8EIX 496403	
TE 125	125	-	-	-	BR7EIX 497115	
TE 250	250	11-	BR7ES	455372	BR7EIX 497115	
TE 300	300	11-	BR7ES	455372	BR7EIX 497115	
HUSQVARNA						
360 WXC	360	98-	B8EG	198244	- -	
701 Enduro, Supermoto - 49kW	701	16	LKAR8BI9 LMAR7A-9	512530 512570	- -	

MOTEUR

CYCLE

PNEUMATIQUE

ATELIER



ACCESSOIRES

ÉLECTRICITÉ

FILTRATION

FREINAGE

TRANSMISSION

Modèle	Cylindrée	Année	Bougie	 		
				Ref CGN standard	Bougie iridium	Ref CGN iridium
701 Enduro, Supermoto - 55kW	701	17-	LKAR9BI-10 LMAR7DI-10	512608 512504	-	-
AC 510	510	-	DP8EA-9	214029	DPR8EIX-9	496388
CR 125	125	97-	-	-	BR10EIX	381617
CR 125	125	01-12	BR9EG	1892	-	-
CR 125	125	13-	BR9EG	1892	-	-
CR 125	125	99-00	BR9EG	1892	-	-
CR 250	250	90-	-	-	BR9EIX	381511
CR 250	250	95-00	-	-	BR9EIX	381511
CR 250	250	01-	BR8EG	214162	-	-
CR 360	360	91-	-	-	BR8EIX	381507
CR 390	390	-	B8EG	198244	-	-
CR 430	430	-	B8EG	198244	BR8EIX	381507
CR 430	430	-	B9ES	1844	BR9EIX	381511
CR 435	435	-	B8EG	198244	BR8EIX	381507
CR 500	500	-	B8EG	198244	-	-
FC 250	250	14-	LMAR9AI-8	512607	-	-
FC 350	350	14-	LMAR9AI-8	512607	-	-
FC 450	450	14-15	LKAR8AI-9	512500	-	-
FC 450	450	16-	LMAR9AI-8	512607	-	-
FE 250	250	14-	LMAR9AI-10	512499	-	-
FE 350	350	14-16	LMAR9AI-8	512607	-	-
FE 350	350	17-	LMAR9AI-10	512499	-	-
FE 450	450	14-16	LKAR8AI-9	512500	-	-
FE 450	450	17-	LMAR9AI-10	512499	-	-
FE 501	510	14-16	LKAR8AI-9	512500	-	-
FE 501	510	17-	LMAR9AI-10	512499	-	-
FR 450 Rally	450	17-	LKAR8AI-9	512500	-	-
FS 450	450	15	LKAR8AI-9	512500	-	-
FS 450	450	16-	LMAR9AI-8	512607	-	-
FX 350	350	17-	LMAR9AI-8	512607	-	-
FX 450	450	17-	LMAR9AI-8	512607	-	-
LT 610	610	00-	C7E	512444	CR7EIX	490469
MX 390	390	-	B9ES	1844	BR9EIX	381511
MX 400	400	-	B9ES	1844	BR9EIX	381511
Nuda 900	898	12-	LMAR8C-9	512507	-	-
Nuda 900 R	898	12-	LMAR8C-9	512507	-	-
R 400 R	400	01-	CR8EB	384085	CR8EIX	490470
SM 125	125	99-	BR9EG	1892	BR9EIX	381511
SM 125	125	02-	BR9EG	1892	-	-
SM 125 S	125	02-	BR9EG	1892	-	-
SM 400 R	400	01-	CR8EB	384085	CR8EIX	490470
SM 450 R	450	03-	CR8EB	384085	CR8EIX	490470



Modèle	Cylindrée	Année	Bougie		
				Ref CGN standard	Ref CGN iridium
SM 450 RR i.e	450	08-	CR9EKB	496397	381550
SM 510 R	510	-	CR8EB	384085	490470
SM 530 RR	530	08-	CR8EB	384085	490470
SM 530 RR	530	09-	CR9EKB	496397	381550
SM 570 R	570	01-	C7E	512444	490469
SM 570 R	570	02-04	C7E	512444	490469
SM 570 R	570	04-	C8E	512606	490470
SM 610	610	06-	CPR8E	336134	-
SM 610 E	610	98-	C7E	512444	490469
SM 610 ie	610	09-	CPR8E	336134	-
SM 610 R	610	00-	C7E	512444	490469
SM 610 S	610	98-	C7E	512444	490469
SM 610 S	610	03-	C7E	512444	490469
SM 610 S Competition	610	03-	C8E	512606	490470
SM 610 S Standard	610	98-05	CR7E	213902	490469
SM 630	630	09-	CR8EB	384085	490470
SM S 125	125	00-	BR9EG	1892	-
SM S 125	125	11-	CR8E	1862	490470
SMR 449	450	11-	CR9EKB	496397	381550
SMR 450	450	04-	CR8EB	384085	490470
SMR 450	450	03-	CR7EB	450804	490469
SMR 480	480	11-	CR9EKB	496397	381550
SMR 511	480	11-	CR9EKB	496397	381550
SMR 570	570	03-	CR7EB	450804	490469
SMR 570 NOX	570	02-	R0045Q-10	512443	-
SMR 570 NOX Super Motard	570	01-	C7E	512444	490469
SMR 630	630	04-	R0045Q-10	512443	-
SMR 630	630	10-	CR8EB	384085	490470
SMS 4	125	11-	CR8E	1862	490470
SMS 600 ie	600	11-	CR8EB	384085	490470
TC 125	125	-	BR9EG	1892	381511
TC 250	250	09-	CR9EB	328861	381550
TC 250	250	01-08	CR8EB	384085	490470
TC 250	250	14-	BR8ECM	496394	512423
TC 250 4T	250	05-	CR8EB	384085	490470
TC 449	450	11-	CR9EKB	496397	381550
TC 450	450	01-	CR8EB	384085	490470
TC 450	450	04-	CR8EB	384085	490470
TC 510	510	-	CR8EB	384085	490470
TC 570	576	01-	CR7EB	450804	490469
TC 610	610	91-	C7E	512444	490469
TC 610 E	610	98-	C7E	512444	490469

Modèle	Cylindrée	Année	NGK		NGK	
			Bougie	Ref CGN standard	Bougie iridium	Ref CGN iridium
TE 125	125	11-13	CR8E	1862	CR8EIX	490470
TE 125	125	14-16	-	-	BR9ECMIX	496382
TE 125 4T	125	11-	CR8E	1862	CR8EIX	490470
TE 150	150	17-	-	-	BR9ECMIX	496382
TE 250	250	09-	CR9EB	328861	CR9EIX	381550
TE 250	250	13	CR9EIA-9	496379	-	-
TE 250	250	14-17	BR7ES	455372	BR7EIX	497115
TE 250	250	01-07	CR8EB	384085	CR8EIX	490470
TE 250 i.e.	250	08-	CR9EB	328861	CR9EIX	381550
TE 250 Meo Replica	250	11-	CR9EB	328861	CR9EIX	381550
TE 250 R	250	01-07	CR8EB	384085	CR8EIX	490470
TE 250i	250	18-	ZGR7GI-13G	512502	-	-
TE 300	300	14-17	BR7ES	455372	BR7EIX	497115
TE 300i	300	18-	ZGR7GI-13G	512502	-	-
TE 310	310	09-10	CR8EB	384085	CR8EIX	490470
TE 310	310	11-	CR9EB	328861	CR9EIX	381550
TE 310	310	11-12	CR9EB	328861	CR9EIX	381550
TE 310	310	13	CR9EIA-9	496379	-	-
TE 350	350	90-	C7E	512444	CR7EIX	490469
TE 350	350	95-	C7E	512444	CR7EIX	490469
TE 400	400	01-	C7E	512444	CR7EIX	490469
TE 400 R	400	01-	CR8EB	384085	CR8EIX	490470
TE 410	410	95-96	C7E	512444	CR7EIX	490469
TE 410	410	96-00	C7E	512444	CR7EIX	490469
TE 410 E	410	99-00	CR7E	213902	CR7EIX	490469
TE 449	450	11-	CR9EKB	496397	CR9EIX	381550
TE 450	450	03-	CR8EB	384085	CR8EIX	490470
TE 450	450	13-	CR9EKB	496397	CR9EIX	381550
TE 480	480	11-	CR9EKB	496397	CR9EIX	381550
TE 510	450	03-	CR8EB	384085	CR8EIX	490470
TE 510	510	-	DP8EA-9	214029	DPR8EIX-9	496388
TE 510	510	05-	CR8EB	384085	CR8EIX	490470
TE 510 Centennial	510	-	CR8EB	384085	CR8EIX	490470
TE 511	480	11-	CR9EKB	496397	CR9EIX	381550
TE 570	576	01-	CR7EB	450804	CR7EIX	490469
TE 600 ie	600	11-	CR8EB	384085	CR8EIX	490470
TE 610	610	91-	C7E	512444	CR7EIX	490469
TE 610	610	-	CPR8E	336134	-	-
TE 610 E	610	98-	C7E	512444	CR7EIX	490469
TE 610 E	610	98-05	CR7E	213902	CR7EIX	490469
TE 610 ie	610	09-	CPR8E	336134	-	-
TE 630	630	10-	CR8EB	384085	CR8EIX	490470



Modèle	Cylindrée	Année	Bougie	NOK		
				Ref CGN standard	Ref CGN iridium	
TE 630	630	10-	CR8EB	384085	490470	
TR 650 Strada	650	12-	MAR9A-J	512461	-	
TR 650 Strada	650	13-	MAR9A-6J	512503	-	
TR 650 Terra	650	12-	MAR9A-J	512461	-	
TR 650 Terra	650	13-	MAR9A-6J	512503	-	
TX 125	125	17-	-	-	496382	
TX 300	300	17-	BR7ES	455372	497115	
TXC 250	250	10-	CR9EB	328861	381550	
Vitpilen 701	701	18-	LKAR9BI-10 LMAR7DI-10	512608 512504	-	
WR 125	125	95-00	-	-	381617	
WR 125	125	01-	BR9EG	1892	-	
WR 125	125	13-	BR9EG	1892	-	
WR 125 2T	125	05-	BR9EG	1892	-	
WR 240	240	-	B8EG	198244	-	
WR 250	250	92-95	-	-	381511	
WR 250	250	96-99	-	-	381511	
WR 250	250	99-12	B8EG	198244	-	
WR 250	250	13-	BR8EG	214162	-	
WR 250	250	01-	BR8EG	214162	-	
WR 250 2T	250	12-	BR8EG	214162	-	
WR 260	260	90-	-	-	381511	
WR 300	300	09-	BR8EG	214162	-	
WR 350	350	92-02	-	-	381511	
WR 360	360	91-97	-	-	381507	
WR 360	360	98-00	B8EG	198244	-	
WR 360	360	01-	B8EG	198244	-	
WR 400	400	-	B8EG	198244	381507	
WR 430	430	-	B8EG	198244	381507	
WR 500	500	-	B8EG	198244	-	
WRE 125	125	98-01	B9EG	1869	-	
WRE 125	125	02-	BR9EG	1892	381511	
WRE 125 Compétition	125	98-	R7435-10	512501	-	
WSM 125	125	04-	CR7HSA	1861	496398	
WXE 125	125	04-	CR7HSA	1861	496398	
HYOSUNG						
Boomer 125 Exceed MSI	125	02-	DR8EA	198225	493825	
GA 125 Cruise II Classic (CLS)	125	99-	CR8EH-9	198263	496404	
GA 125 Cruise III	125	00-	CR8EH-9	198263	496404	
GF 125 I	125	98-	CR8EH-9	198263	496404	
GF 125 II	125	98-	CR8EH-9	198263	496404	
GPS 125 Grand Prix	125	-	DR8EA	198225	493825	
GPS 125 Grand Prix Plus	125	99-05	DR8EA	198225	493825	

Modèle	Cylindrée	Année	NGK		Ref CGN iridium
			Bougie	Ref CGN standard	
GPS 125 Grand Prix Plus 2	125	01-	DR8EA	198225	493825
GPS 125 Hyper	125	98-	DR8EA	198225	493825
GS 125 Cruise I	125	96	D8EA	1855	493825
GS 125 Cruise I	125	97-	DR8EA	198225	493825
GS 125 Cruise II	125	97-	CR8EH-9	198263	496404
GT 125	125	03-	CR8E	1862	490470
GT 125	125	05-	CR8EH-9	198263	496404
GT 125 Comet	125	01-	CR8E	1862	490470
GT 125 Naked	125	01-	CR8E	1862	490470
GT 125 R	125	05-	CR8EH-9	198263	496404
GT 125 R	125	06-	CR8E	1862	490470
GT 125 R TTC	125	07-	CR8E	1862	490470
GT 250	250	05-	CR8E	1862	490470
GT 250 Comet	250	08-	CR8E	1862	490470
GT 250 EFI	250	08-	CR8E	1862	490470
GT 250 R	250	06-08	CR8E	1862	490470
GT 250 R EFI	250	08-	CR8E	1862	490470
GT 650	650	05-	CR8E	1862	490470
GT 650 Comet	650	03-	CR8E	1862	490470
GT 650 Comet	650	07-	CR8E	1862	490470
GT 650 Comet	650	08-	CR8E	1862	490470
GT 650 EFI	650	08-	CR8E	1862	490470
GT 650 i Naked	650	07-	CR8E	1862	490470
GT 650 i R	650	07-	CR8E	1862	490470
GT 650 N	650	12-	CR8E	1862	490470
GT 650 Naked	650	04-	CR8E	1862	490470
GT 650 R	650	05-06	CR8E	1862	490470
GT 650 R EFI	650	08-	CR8E	1862	490470
GT 650 S	650	05-06	CR8E	1862	490470
GT 650 X	650	08-	CR8E	1862	490470
GV 125 Aquila	125	00-	CR8E	1862	490470
GV 125 C	125	08-	CR8E	1862	490470
GV 125 M Cruiser	125	07-	CR8E	1862	490470
GV 250 Aquila	250	00-	CR8E	1862	490470
GV 250 Aquila	250	08-	CR8E	1862	490470
GV 250 Aquila 8V	250	00-	CR8E	1862	490470
GV 250 EFI	250	08-	CR8E	1862	490470
GV 650	650	06-	CR8E	1862	490470
GV 650 Aquila	650	06-08	CR8E	1862	490470
GV 650 Aquila	650	08-	CR8E	1862	490470
GV 650 EFI	650	08-	CR8E	1862	490470
GV 650i Sportcruiser	650	07-	CR8E	1862	490470



Modèle	Cylindrée	Année	NOK		NOK	
			Bougie	Ref CGN standard	Bougie iridium	Ref CGN iridium
GV 700 C EFI	680	10-	CR8E	1862	CR8EIX	490470
HD 125 Hyper	125	04-06	DR8EA	198225	DR8EIX	493825
MS3 125 i	125	07-	CR8E	1862	CR8EIX	490470
MS3 250 i	250	07-	CR8E	1862	CR8EIX	490470
RT 125 D	125	07-	CR8E	1862	CR8EIX	490470
RT 125 D Karion	125	07-	CR8EH-9	198263	CR8EHIX-9	496404
RT 125 Karion	125	02-06	CR8EH-9	198263	CR8EHIX-9	496404
RT 125 Karion	125	10-	C8EH-9	512596	CR8EHIX-9	496404
RX 125	125	00-07	CR8EH-9	198263	CR8EHIX-9	496404
RX 125 D	125	07-	CR8EH-9	198263	CR8EHIX-9	496404
RX 125 D E	125	07-	CR8E	1862	CR8EIX	490470
RX 125 D SM	125	07-	CR8E	1862	CR8EIX	490470
RX 125 SM	125	10-	CR8EH-9	198263	CR8EHIX-9	496404
ST 700 i	700	10-	CR8E	1862	CR8EIX	490470
XRX 125 Funduro	125	10-	CR8E	1862	CR8EIX	490470
XRX 125 Supermoto	125	10-	CR8E	1862	CR8EIX	490470
XRX 125 Trail	125	99-	CR8EH-9	198263	CR8EHIX-9	496404
INDIAN						
Chief	1450	99-01	BPR5ES-11	512467	BPR5EIX-11	512425
Chief	1650	02-	BPR5ES-11	512467	BPR5EIX-11	512425
Chief	1800	17-18	DCPR8E	512442	DCPR8EIX	496403
Chief Classic	1800	16	DCPR8E	512442	DCPR8EIX	496403
Chief Dark Horse	1800	16	DCPR8E	512442	DCPR8EIX	496403
Chief Vintage	1800	16	DCPR8E	512442	DCPR8EIX	496403
Chieftain	1800	16-18	DCPR8E	512442	DCPR8EIX	496403
Chieftain Dark Horse	1800	16-18	DCPR8E	512442	DCPR8EIX	496403
Chieftain Elite	1800	17	DCPR8E	512442	DCPR8EIX	496403
Chieftain Limited	1800	17-18	DCPR8E	512442	DCPR8EIX	496403
Dakota 4 (Carburetor)	1850	03-	BPR6HS	1886	BPR6HIX	512414
Dakota 4 (Injection)	1850	03-	BPR7HS	1887	BPR7HIX	497112
Dakota 4 Classic (Carburetor)	1850	03-	BPR6HS	1886	BPR6HIX	512414
Dakota 4 Classic (Injection)	1850	03-	BPR7HS	1887	BPR7HIX	497112
Dakota 4 Highway (Carburetor)	1850	03-	BPR6HS	1886	BPR6HIX	512414
Dakota 4 Highway (Injection)	1850	03-	BPR7HS	1887	BPR7HIX	497112
Dakota 4 si (Carburetor)	1850	03-	BPR6HS	1886	BPR6HIX	512414
Dakota 4 si (Injection)	1850	03-	BPR7HS	1887	BPR7HIX	497112
Roadmaster	1800	16-18	DCPR8E	512442	DCPR8EIX	496403
Roadmaster Classic	1800	17-18	DCPR8E	512442	DCPR8EIX	496403
Roadmaster Elite	1800	18	DCPR8E	512442	DCPR8EIX	496403
Scout	1130	16-18	MR7F	512508	-	-
Scout	1450	01-	BPR5ES-11	512467	BPR5EIX-11	512425
Scout Bobber	1130	18	MR7F	512508	-	-

MOTEUR

CYCLE

PNEUMATIQUE

ATELIER



ACCESSOIRES

ÉLECTRICITÉ

FILTRATION



FREINAGE

TRANSMISSION

Modèle	Cylindrée	Année	Bougie	 		
				Ref CGN standard	Bougie iridium	Ref CGN iridium
Scout Sixty	1000	16-18	MR7F	512508	-	-
Spirit	1450	01-	BPR5ES-11	512467	BPR5EIX-11	512425
Springfield	1800	16-18	DCPR8E	512442	DCPR8EIX	496403
Springfield Dark Horse	1800	18	DCPR8E	512442	DCPR8EIX	496403
ITALJET						
Dragster 125	125	97	B7HS	1835	BR7HIX	497113
Dragster 125	125	98-04	BR9ES	1890	BR9EIX	381511
Dragster 125	125	00-	BP7HS	490460	BPR7HIX	497112
Dragster 180	180	98-	BR9ES	1890	BR9EIX	381511
Formula 125	125	-	BR7HS	172707	BR7HIX	497113
Formula 125	125	97-98	B7HS	1835	BR7HIX	497113
Formula 125	125	98-	BR8HS	195431	BR8HIX	381492
Jet-Set 125 4T	125	-	CR7E	213902	CR7EIX	490469
Jet-Set 150 4T	150	-	CR7E	213902	CR7EIX	490469
Jupiter 125	125	-	CR8E	1862	CR8EIX	490470
Jupiter 150	150	-	CR8E	1862	CR8EIX	490470
Jupiter 250	250	-	DR8EA	198225	DR8EIX	493825
Millenium 125 4T	125	99-	CR8E	1862	CR8EIX	490470
Millenium 150	150	-	CR8E	1862	CR8EIX	490470
Millenium 250	250	99-	DR8EA	198225	DR8EIX	493825
Super Range	125	-	B7HS	1835	BR7HIX	497113
Torpedo 125 4T	125	98-	CR7E	213902	CR7EIX	490469
Torpedo 150 4T	150	99-	CR8EB	384085	CR8EIX	490470
Union 125	125	98-	BP7HS	490460	BPR7HIX	497112
JAWA						
350 Gespann	350	87-	B6HS	1834	BR6HIX	497114
350 Style	350	93-	B8HS	1837	BR8HIX	381492
500 DT Speedway	500	-	-	-	BR9EIX	381511
500 R	500	-	D8EA	1855	DR8EIX	493825
500 R Spezial	500	-	-	-	DR8EIX	493825
634	350	-	B6HS	1834	BR6HIX	497114
638	350	-	B6HS	1834	BR6HIX	497114
638.5 Gespann	350	85-	B6HS	1834	BR6HIX	497114
639	350	-	B6HS	1834	BR6HIX	497114
640	350	-	B6HS	1834	BR6HIX	497114
Chopper 350	350	-	B8HS	1837	BR8HIX	381492
Classic 650	650	04-	DR8EA	198225	DR8EIX	493825
CZ 125 Oilmaster	125	84-	B8HS	1837	BR8HIX	381492
CZ 175	175	84-	B8HS	1837	BR8HIX	381492
CZ 180	180	84-	B8HS	1837	BR8HIX	381492
CZ 250	250	84-	B8HS	1837	BR8HIX	381492
CZ 350	350	84-	B8HS	1837	BR8HIX	381492



Modèle	Cylindrée	Année	Bougie	NOK		
				Ref CGN standard	Ref CGN iridium	
CZ 350 Chopper	350	84-	B8HS	1837	BR8HIX 381492	
CZ 350 Classic	350	84-	B8HS	1837	BR8HIX 381492	
CZ 350 Sport	350	84-	B8HS	1837	BR8HIX 381492	
CZ 350 Style	350	84-	B8HS	1837	BR8HIX 381492	
Dakar 125	125	03-	D8EA	1855	DR8EIX 493825	
Dakar 650	650	06-	DR8EA	198225	DR8EIX 493825	
Dandy 125	125	99-	D8EA	1855	DR8EIX 493825	
Dandy 125	125	00-	DR8ES	1858	DR8EIX 493825	
Scot 'Sabater 350	350	00-	B8HS	1837	BR8HIX 381492	
Sport 125	125	03-	D8EA	1855	DR8EIX 493825	
Style 350	350	-	B8HS	1837	BR8HIX 381492	
Style 650	650	04-	DR8EA	198225	DR8EIX 493825	
TS 350	350	86-	B6HS	1834	BR6HIX 497114	
Twin Sport	350	-	B8HS	1837	BR8HIX 381492	
JCM						
Trial	125	-	BP6ES	490457	BPR6EIX 512415	
Trial	240	-	BP7ES	490459	BPR7EIX 512582	
Trial	333	-	BP7ES	490459	BPR7EIX 512582	
JIALING						
JH	125	94-	DR8ES-L	1859	DR8EIX 493825	
Sanyang Duke	125	-	DPR7EA-9	198282	DPR7EIX-9 512580	
Sanyang Wolf	125	-	DR8ES-L	1859	DR8EIX 493825	
JIANSHE						
JS125Y Tiger	125	03-	DR8ES	1858	DR8EIX 493825	
JINCHENG						
JC 125 A, JC 125 7B	125	-	DR8EA	198225	DR8EIX 493825	
JMSTAR						
CJ12M	125	-	C7HSA	465600	CR7HIX 496398	
JOHN DEERE - SSV						
Gator 4x2	-	-	BPR6ES	198187	BPR6EIX 512415	
Gator 6x4	854	-	BMR2A-10	512510	- -	
Gator Kawasaki 10 hp	-	-	B5HS	1833	- -	
Gator Kawasaki FD620D 20hp	-	-	BMR2A-10	512510	- -	
Gator Kawasaki FE250D 8hp	250	-	BPR5ES	198191	BPR5EIX 511478	
Gator Kawasaki FE290D 9.5hp	290	-	BPR5ES	198191	BPR5EIX 511478	
Gator Kawasaki OHV 18hp	-	-	BMR6A	1879	- -	
JONWAY						
Adventure 125	125	09-	C7HSA	465600	CR7HIX 496398	
YY 125 T	125	09-	CR7HSA	1861	CR7HIX 496398	
	125	09-	CR7HSA	1861	CR7HIX 496398	
KAWASAKI						
BJ 250	250	93-	DR8ES	1858	DR8EIX 493825	

Modèle	Cylindrée	Année	Bougie	 		
				Ref CGN standard	Bougie iridium	Ref CGN iridium
BJ 250 A Estrella	250	94-96	DR8ES	1858	DR8EIX	493825
BJ 250 C Estrella	250	97	DR9EA	214048	DR9EIX	512583
BN 125	125	98-	CR7E	213902	CR7EIX	490469
BN 125 A Eliminator - 4>8, 6F>7F	125	01-07	CR7E	213902	CR7EIX	490469
BN 125 Eliminator	125	97-	CR8E	1862	CR8EIX	490470
BR 250 - Z250SL	250	15-	MR8CI-8	512514	-	-
BX 250 - Ninja 250SL	250	15-	MR8CI-8	512514	-	-
EL 252 F Eliminator - 2>3	252	96-99	CR8HSA	213917	CR8HIX	504033
EN 500 B	500	94-95	DR9EA	214048	DR9EIX	512583
EN 500 C	500	96-99	DR9EA	214048	DR9EIX	512583
ER 300 - Z300	300	15-	CR8E	1862	CR8EIX	490470
ER 500 A Twister	500	97-00	DR9EA	214048	DR9EIX	512583
ER5 B Twister	500	97-00	DR9EA	214048	DR9EIX	512583
ER5 C Twister	500	01-06	DR9EA	214048	DR9EIX	512583
ER5 D Twister	500	01-06	DR9EA	214048	DR9EIX	512583
ER6F 650	650	06-	CR9EIA-9	496379	-	-
ER6N 650	650	06-	CR9EIA-9	496379	-	-
EX 250 - K8F	250	08-12	CR8E	1862	CR8EIX	490470
EX 250 R	250	93-96	CR8HSA	213917	CR8HIX	504033
EX 400	400	18-	LMAR9G	512515	-	-
EX 500 E10	500	02-04	DR9EA	214048	DR9EIX	512583
EX 500 R Ninja	500	93-97	DR9EA	214048	DR9EIX	512583
EX 650 Ninja -	650	17-	CR9EIA-9	496379	-	-
GPX 250 R -	250	99	CR8HSA	213917	CR8HIX	504033
GPX 600 -	600	93-99	DR9EA	214048	DR9EIX	512583
GPZ 1100 E	1100	95-98	CR9EK	213936	CR9EIX	381550
GPZ 1100 F	1100	96-98	CR9EK	213936	CR9EIX	381550
GPZ 305 B Belt drive - B2-B10	305	84-96	DPR9EA-9	1860	DPR9EIX-9	512585
GPZ 500 S	500	94-03	DR9EA	214048	DR9EIX	512583
GTR 1000 A	1000	86-95	DR8ES	1858	DR8EIX	493825
GTR 1000 A	1000	96-03	DR9EA	214048	DR9EIX	512583
GTR 1400 A	1400	08-	CR9EIA-9	496379	-	-
GTR 1400 Grand Tourer	1400	11-	CR9EIA-9	496379	-	-
H1 500 Mach 3 - Ignition mech, elektr	500	68-	B9HCS	512610	BR9HIX	1851
J 125 - SOHC	125	16-	CR7E	213902	CR7EIX	490469
J 300 - SOHC	300	14-	CR7E	213902	CR7EIX	490469
KDX 125 SR -	125	90-96	BR8ES	1889	BR8EIX	381507
KDX 200 H - 1>11, 6F	200	95-06	BR8ES	1889	BR8EIX	381507
KDX 220 A - 4>7	220	97-00	BR8ES	1889	BR8EIX	381507
KDX 220 A - 8>12	220	01-05	BR8ES	1889	BR8EIX	381507
KDX 220 R -	220	97-05	BR8ES	1889	BR8EIX	381507
KFX 450 R	450	08-	CPR8EB-9	490493	-	-





Modèle	Cylindrée	Année	NOK		NOK	
			Bougie	Ref CGN standard	Bougie iridium	Ref CGN iridium
KH 125 -	125	93-95	BR8ES	1889	BR8EIX	381507
KL 250 G - AF	250	10-	CR8E	1862	CR8EIX	490470
KLE 500	500	91-07	DR9EA	214048	DR9EIX	512583
KLE 650 Versys	650	10-	CR9EIA-9	496379	-	-
KLE 650 Versys - 7F>9F	650	07-	CR9EIA-9	496379	-	-
KLE 650 Versys ABS EF	650	14-	CR9EIA-9	496379	-	-
KLE 650 Versys Tourer	650	11-	CR9EIA-9	496379	-	-
KLR 250 D - 1~22	250	84-05	DPR9EA-9	1860	DPR9EIX-9	512585
KLR 650 C	650	95-04	DPR8EA-9	1857	DPR8EIX-9	496388
KLR 650 New Edition	650	14-	DPR8EA-9	1857	DPR8EIX-9	496388
KLT 160 - 3-Wheel	160	85-	D8EA	1855	DR8EIX	493825
KLV 1000 A	1000	04-06	CR8EK	461666	CR8EIX	490470
KLX 125 A - 1>4	125	03-06	DR8EA	198225	DR8EIX	493825
KLX 125 C	125	10-	CR7HSA	1861	CR7HIX	496398
KLX 125 D DTracker	125	10-	CR7HSA	1861	CR7HIX	496398
KLX 125 L - 1>4	125	03-06	DR8EA	198225	DR8EIX	493825
KLX 140 A - 8F~9F, AF>FF	140	08-15	CR7HSA	1861	CR7HIX	496398
KLX 140 L - 8F~9F, AF>FF	140	08-15	CR7HSA	1861	CR7HIX	496398
KLX 250 R - D1>D4	250	93-96	CR8E	1862	CR8EIX	490470
KLX 250 S - 9F, AF	250	09-10	CR8E	1862	CR8EIX	490470
KLX 250 S - BF	250	11-	CR8E	1862	CR8EIX	490470
KLX 300 R - A1>10	300	96-05	CR8E	1862	CR8EIX	490470
KLX 300 R - A6F>A7F	300	06-07	CR8E	1862	CR8EIX	490470
KLX 400 R - B1>2	400	03-04	CR8E	1862	CR8EIX	490470
KLX 400 SR - A1	400	03-	CR8E	1862	CR8EIX	490470
KLX 450	450	08-	CPR8EB-9	490493	-	-
KLX 450 R	450	08-	CPR8EB-9	490493	-	-
KLX 450 R - ACF>AEF	450	12-14	CPR8EB-9	490493	-	-
KLX 650	650	93-95	DPR8EA-9	1857	DPR8EIX-9	496388
KLX 650 R	650	93-01	DPR8EA-9	1857	DPR8EIX-9	496388
KLZ 1000 Versys - ACF	1000	12	CR9EIA-9	496379	-	-
KMX 125	125	86-00	BR8ES	1889	BR8EIX	381507
KX 125	125	90-	R6254E-105	1854	-	-
KX 125 K - 2>3	125	95-96	-	-	BR9EIX	381511
KX 125 K - 4	125	97	R6252K-105	512511	-	-
KX 125 K - 5	125	98	-	-	BR9EIX	381511
KX 125 L - 1	125	99	-	-	BR9EIX	381511
KX 125 L - 2>3	125	00-01	-	-	BR9EIX	381511
KX 125 L - 4	125	02	-	-	BR9EIX	381511
KX 125 M - 1	125	03	-	-	BR9EIX	381511
KX 125 M - 2	125	04	R6918B-9	512513	-	-
KX 125 M - 3	125	05	R6918B-9	512513	-	-

Modèle	Cylindrée	Année	NGK		NGK	
			Bougie	Ref CGN standard	Bougie iridium	Ref CGN iridium
KX 125 M - 6	125	06-	-	-	BR9ECMIX	496382
KX 250 F 4T - N1	250	04	CR8EB	384085	CR8EIX	490470
KX 250 F 4T - N2	250	05	CR8EB	384085	CR8EIX	490470
KX 250 F 4T - T6F>T8F, W9F	250	06-09	CR8E	1862	CR8EIX	490470
KX 250 F 4T - W9FA	250	09-	CR8E	1862	CR8EIX	490470
KX 250 F 4T - XAFB	250	10-	CR8E	1862	CR8EIX	490470
KX 250 F 4T - YBF>YCF	250	11-12	CPR8EB-9	490493	-	-
KX 250 F 4T - ZDF~ZFF	250	13-15	CPR8EB-9	490493	-	-
KX 250 K - 2>5	250	95-98	-	-	BR8EIX	381507
KX 250 L - 1>4	250	99-02	-	-	BR8EIX	381507
KX 250 M - 1>2	250	03-04	-	-	BR8EIX	381507
KX 250 R - 6F>7F	250	05-07	-	-	BR8ECMIX	512423
KX 450 F - D6F>D8F	450	06-08	CPR8EB-9	490493	-	-
KX 450 F - E9F, EAF>EBF, FCF>FDF	450	09-13	CPR8EB-9	490493	-	-
KX 450 F - FDF>FFF	450	13-15	CPR8EB-9	490493	-	-
KX 500 D - 1	500	88-00	BR8EG	214162	-	-
KX 500 E - 1>12	500	88-00	BR8EG	214162	-	-
KX 500 E - 13>16	500	01-04	BR8EG	214162	-	-
KZ 1000 Police - P10>19	1000	91-00	BR8ES	1889	BR8EIX	381507
KZ 1000 Police - P20>24	1000	01-05	BR8ES	1889	BR8EIX	381507
LX 250	250	09-11	BR7ES	455372	BR7EIX	497115
Ninja 250 SL A - GF, FS, FF	250	15-	MR8CI-8	512514	-	-
Ninja 250 SL B ABS - GF, FS, FF	250	15-	MR8CI-8	512514	-	-
Ninja 250 SL B KRT Edition ABS - GFA, FSA	250	15-16	MR8CI-8	512514	-	-
Ninja EX 250 R - K8F	250	08-	CR8E	1862	CR8EIX	490470
Ninja EX 250 R - K9F	250	09-	CR8E	1862	CR8EIX	490470
Ninja EX 250 R - KAF	250	10-	CR8E	1862	CR8EIX	490470
Ninja EX 250 R - KBF	250	11-	CR8E	1862	CR8EIX	490470
Ninja EX 250 R - KCF	250	12-14	CR8E	1862	CR8EIX	490470
Ninja EX 300	300	13-	CR8E	1862	CR8EIX	490470
Ninja H2	1000	18-	SILMAR9E9	512516	-	-
Ninja H2 - FF	1000	15-	SILMAR9B9	512517	-	-
Ninja H2R	1000	15-	SILMAR9B9	512517	-	-
S3 400	400	74-	B9HS	1838	BR9HIX	1851
S3 400 A	400	75-	B9HS	1838	BR9HIX	1851
SC 300 - J300	300	14-	CR7E	213902	CR7EIX	490469
VN 1500 D Classic	1500	96-97	DPR7EA-9	198282	DPR7EIX-9	512580
VN 1500 F Classic	1500	98-99	DPR5EA-9	512519	-	-
VN 1500 G Classic Tourer	1500	98-99	DPR5EA-9	512519	-	-
VN 1500 H Classic Tourer	1500	98-99	DPR5EA-9	512519	-	-
VN 1500 J Drifter	1500	99-00	DPR6EA-9	490471	-	-
VN 1500 L Classic Tourer	1500	00-04	DPR6EA-9	490471	-	-



Modèle	Cylindrée	Année	Bougie			
				Ref CGN standard	Ref CGN iridium	
VN 1500 N Classic	1500	00-02	DPR6EA-9	490471	-	-
VN 1500 P Mean Streak	1500	02-03	DPR6EA-9	490471	-	-
VN 1500 R Drifter	1500	01-03	DPR6EA-9	490471	-	-
VN 1600 A Classic	1600	03-08	DPR6EA-9	490471	-	-
VN 1600 B Mean Streak	1600	04-08	DPR6EA-9	490471	-	-
VN 1600 D Classic Tourer	1600	05-08	DPR6EA-9	490471	-	-
VN 1700 Classic	1700	09-	ILZKAR7B11	512520	-	-
VN 1700 Classic Tourer	1700	09-	ILZKAR7B11	512520	-	-
VN 1700 Light Tourer	1700	11-	ILZKAR7B11	512520	-	-
VN 1700 Voyager	1700	09-	ILZKAR7B11	512520	-	-
VN 1700 Voyager Custom	1700	11-	ILZKAR7B11	512520	-	-
VN 2000 A	2000	04-08	IZFR6F11	512611	ZFR6FIX-11	512432
VN 2000 H Classic	2000	08-	IZFR6F11	512611	ZFR6FIX-11	512432
VN 750 Twin	750	86-95	DPR7EA-9	198282	DPR7EIX-9	512580
VN 800 A	800	95-99	CR7E	213902	CR7EIX	490469
VN 800 B Classic	800	96-06	CR7E	213902	CR7EIX	490469
VN 800 C Drifter	800	99-00	CR7E	213902	CR7EIX	490469
VN 800 E Drifter	800	01-03	CR7E	213902	CR7EIX	490469
VN 800 Vulcan	800	06-	CPR7EA-9	496389	CPR7EAIX-9	512587
VN 900 B Classic	900	06-	CPR7EA-9	496389	CPR7EAIX-9	512587
VN 900 C Custom	900	07-	CPR7EA-9	496389	CPR7EAIX-9	512587
VN 900 Classic Special	900	11-	CPR7EA-9	496389	CPR7EAIX-9	512587
VN 900 Light Tourer	900	11-	CPR7EA-9	496389	CPR7EAIX-9	512587
VNI5 1500	1500	88-95	DPR7EA-9	198282	DPR7EIX-9	512580
W 650	650	99-06	CR8E	1862	CR8EIX	490470
W 800 A	800	11-	CR8E	1862	CR8EIX	490470
W 800 A Special Edition	800	12-	CR8E	1862	CR8EIX	490470
Z 1000 A - IH>6F	1000	03-06	CR9EK	213936	CR9EIX	381550
Z 1000 C	1000	07-09	CR9EIA-9	496379	-	-
Z 1000 E	1000	10-	CR9EIA-9	496379	-	-
Z 1000 H	1000	10-	CR9EIA-9	496379	-	-
Z 1000 SX	1000	10-13	CR9EIA-9	496379	-	-
Z 1000 SX	1000	14-	CR9EIA-9	496379	-	-
Z 1000 SX Tourer	1000	11-13	CR9EIA-9	496379	-	-
Z 250 SL - EGF, EFS, EFF	250	15-	MR8CI-8	512514	-	-
Z 250 SL ABS - GF, FS, FF	250	15-	MR8CI-8	512514	-	-
Z 550 C LTD -	550	80-	DR8ES	1858	DR8EIX	493825
Z 550 C LTD - 1>2	550	81-	D8EA	1855	DR8EIX	493825
Z 550 G - 1>9	550	83-01	DR8ES	1858	DR9EIX	512583
Z 750	750	04-06	CR9EK	213936	CR9EIX	381550
Z 750 ABS	750	07-	CR9EK	213936	CR9EIX	381550
Z 750 P - 7>9	750	91-96	DR8ES	1858	DR9EIX	512583

Modèle	Cylindrée	Année	Bougie	 		
				Ref CGN standard	Bougie iridium	Ref CGN iridium
Z 750 R	750	11-	CR9EK	213936	CR9EIX	381550
Z 750 S	750	05-06	CR9EK	213936	CR9EIX	381550
Z 800	800	14-	CR9EK	213936	CR9EIX	381550
Z 800 EVersion	800	14-	CR9EK	213936	CR9EIX	381550
ZL 600 B Eliminator -	600	95-97	DR9EA	214048	DR9EIX	512583
ZR 1100 A Zephyr	1100	92-95	CR9E	1863	CR9EIX	381550
ZR 1100 B Zephyr	1100	96-97	CR9E	1863	CR9EIX	381550
ZR 1100 C - 1>4	1100	97-01	CR9EK	213936	CR9EIX	381550
ZR 2 Balius -	250	93-96	CR9E	1863	CR9EIX	381550
ZR 750 C Zephyr	750	95	DR9EA	214048	DR9EIX	512583
ZR 750 D Zephyr	750	96-99	DR9EA	214048	DR9EIX	512583
ZR 750 J - 1H	750	04-	CR9EK	213936	CR9EIX	381550
ZR 750 J - 6F	750	05-	CR9EK	213936	CR9EIX	381550
ZR 750 K - 6F	750	06-	CR9EK	213936	CR9EIX	381550
ZR 750 L - 7F, 8F, 9F, AF	750	07-10	CR9EK	213936	CR9EIX	381550
ZR 750 M - 7F, 8F	750	07-10	CR9EK	213936	CR9EIX	381550
ZR 750 N	750	11-	CR9EK	213936	CR9EIX	381550
ZR7 750 F	750	99-04	DR9EA	214048	DR9EIX	512583
ZR7 750 S	750	01-04	DR9EA	214048	DR9EIX	512583
ZRX 1100 C	1100	97-00	CR9EK	213936	CR9EIX	381550
ZRX 1200 C	1200	01-04	CR9EK	213936	CR9EIX	381550
ZRX 1200 R	1200	01-06	CR9EK	213936	CR9EIX	381550
ZRX 1200 S	1200	01-04	CR9EK	213936	CR9EIX	381550
ZX 400	400	91-99	CR9EK	213936	CR9EIX	381550
ZX 600 C - 1>7	600	88-96	DR9EA	214048	DR9EIX	512583
ZX 750	750	04-	DR9EA	214048	DR9EIX	512583
ZX 7R 750 P Ninja	750	96-02	CR9E	1863	CR9EIX	381550
ZX 7RR 750 N Ninja	750	96-99	CR9E	1863	CR9EIX	381550
ZX10R C Ninja	1000	04-05	CR9EIA-9	496379	-	-
ZX10R D Ninja	1000	06-07	CR9EIA-9	496379	-	-
ZX10R E Ninja	1000	08-09	CR9EIA-9	496379	-	-
ZX10R F Ninja	1000	10	CR9EIA-9	496379	-	-
ZX10R Ninja	1000	10-	CR9EIA-9	496379	-	-
ZX-10R Ninja - HF	1000	16-	SILMAR9B9	512517	-	-
ZX-10R Ninja ABS	1000	16-	SILMAR9B9	512517	-	-
ZX-10R Ninja KRT Edition - FA	1000	16-	SILMAR9B9	512517	-	-
ZX11 1100 Ninja	1100	93-	CR9E	1863	CR9EIX	381550
ZX12R 1200 A Ninja	1200	00-01	CR9EKPA	512518	CR9EIX	381550
ZX12R 1200 B Ninja	1200	02-06	CR9EKPA	512518	CR9EIX	381550
ZX6 R Ninja	600	95-08	CR9E	1863	CR9EIX	381550
ZX6 R Ninja	600	09-	CR9E	1863	CR9EIX	381550
ZX6 R Ninja	636	03-08	CR9E	1863	CR9EIX	381550



Modèle	Cylindrée	Année	Bougie	NOK		
				Ref CGN standard	Bougie iridium	Ref CGN iridium
ZX6 R Ninja	636	09-	CR9E	1863	CR9EIX	381550
ZX6 RR Ninja	636	03-	CR9E	1863	CR9EIX	381550
ZX9R B Ninja	900	94-97	CR9EK	213936	CR9EIX	381550
ZX9R C Ninja	900	98-99	CR9EK	213936	CR9EIX	381550
ZX9R D Ninja	900	98-99	CR9EK	213936	CR9EIX	381550
ZX9R E Ninja	900	00-01	CR9EK	213936	CR9EIX	381550
ZX9R F Ninja	900	02-03	CR9EK	213936	CR9EIX	381550
ZXR 250 -	250	93-95	CR9E	1863	CR9EIX	381550
ZXR 400	400	98-99	CR9EK	213936	CR9EIX	381550
ZXR 750 L	750	93-95	CR9E	1863	CR9EIX	381550
ZXR 750 R	750	91-95	CR9E	1863	CR9EIX	381550
ZZR 1100 D	1100	93-97	CR9E	1863	CR9EIX	381550
ZZR 1100 G	1100	98-01	CR9E	1863	CR9EIX	381550
ZZR 1200 C	1200	02-05	CR9E	1863	CR9EIX	381550
ZZR 1400 B	1400	06-07	CR9EIA-9	496379	-	-
ZZR 1400 D	1400	08-11	CR9EIA-9	496379	-	-
ZZR 400 N6	400	98-	CR9EK	213936	CR9EIX	381550
ZZR 400 N7	400	99-	CR9EK	213936	CR9EIX	381550
ZZR 600	600	90-00	CR9E	1863	CR9EIX	381550
ZZR 600	600	01-06	CR9E	1863	CR9EIX	381550
KAWASAKI - SSV						
KAF 300 4x2	300	91-99	BPR5ES	512521	BPR5EIX	511478
KAF 300 A Mule 500 - 1	300	91-	BPR5ES	512521	BPR5EIX	511478
KAF 300 B Mule 500 -1~2	300	95-96	BPR5ES	512521	BPR5EIX	511478
KAF 300 C Mule 550 - 1~7	300	94-04	BPR5ES	512521	BPR5EIX	511478
KAF 300 D Mule 520	300	00-	BPR5ES	512521	BPR5EIX	511478
KAF 400 B Mule 600	400	07-	BPR5ES	512521	BPR5EIX	511478
KAF 400 Mule 4x2	401	-	BPR2ES	512522	-	-
KAF 400 Mule 4x4	401	-	BPR2ES	512522	-	-
KAF 400 Mule 600	401	10-	BPR5ES	512521	BPR5EIX	511478
KAF 400 Mule 610 4x4	401	10-	BPR5ES	512521	BPR5EIX	511478
KAF 450	450	91-	D7EA	512594	DR7EIX	512413
KAF 450 B Mule 1000 UV	450	-	D6EA	512523	-	-
KAF 450 Ref. Liquide	450	92-96	D6EA	512523	-	-
KAF 540 C Mule 2010 UV	540	-	BPR5ES	512521	BPR5EIX	511478
KAF 550	550	94-	BPR5ES	512521	BPR5EIX	511478
KAF 620 A Mule 2510 4x4 - 1~6	620	95-00	BMR2A	512524	-	-
KAF 620 B, C Mule 2520	620	93-	BMR2A	512524	-	-
KAF 620 C Mule 2500 - 1~6	620	95-00	BMR2A	512524	-	-
KAF 620 E Mule 3010 4x4 - 1~4	620	01-04	BPR2ES	512522	-	-
KAF 620 G Mule 3000 - 1~4	620	01-04	BPR2ES	512522	-	-
KEEWAY						
ARN 125	125	08-	DPR7EA-9	198282	DPR7EIX-9	512580

Modèle	Cylindrée	Année	Bougie	 		
				Ref CGN standard	Bougie iridium	Ref CGN iridium
ARN 125	125	09-	CR6HSA	213898	CR6HIX	512424
Cruiser 250	250	06-	D7EA	512594	DR7EIX	512413
F-act 125	125	-	CR7HSA	1861	CR7HIX	496398
Foc. 125	125	-	CR6HSA	213898	CR6HIX	512424
Hacker 125	125	08-	DPR7EA-9	198282	DPR7EIX-9	512580
Matrix 125 V1	125	-	CR6HSA	213898	CR6HIX	512424
Matrix 125 V2	125	-	CR7HSA	1861	CR7HIX	496398
Outlook 125	125	06-	D7EA	512594	DR7EIX	512413
Silver Blade 125	125	07-	D7EA	512594	DR7EIX	512413
Speed 125	125	06-	D7EA	512594	DR7EIX	512413
Speed 125	125	08-	DPR7EA-9	198282	DPR7EIX-9	512580
Speed 125 V1, V2	125	-	DR7ES	512525	DR7EIX	512413
Speed 150	150	06-	D7EA	512594	DR7EIX	512413
Superbike 150	150	-	D7EA	512594	DR7EIX	512413
Superlight 125	125	06-	D7EA	512594	DR7EIX	512413
Superlight 125	125	08-	DPR7EA-9	198282	DPR7EIX-9	512580
Superlight 150	150	06-	D7EA	512594	DR7EIX	512413
Superlight125 V1, V2	125	-	DR7ES	512525	DR7EIX	512413
KREIDLER						
Enduro 125	125	00-	DP7EA-9	512526	DPR7EIX-9	512580
Enduro 125	125	07-	CR8E	1862	CR8EIX	490470
Florett RMC 125	125	05-	CR7HSA	1861	CR7HIX	496398
Flory 125	125	-	CR7HSA	1861	CR7HIX	496398
Mustang 125	125	97	CR7HSA	1861	CR7HIX	496398
Mustang 125	125	98-00	DR8EA	198225	DR8EIX	493825
RMC F 125	125	07-	CR7HSA	1861	CR7HIX	496398
Supermoto 125	125	07-09	CR8E	1862	CR8EIX	490470
Supermoto 125 DD	125	04-07	CR8E	1862	CR8EIX	490470
Supermoto 125 DD	125	10-	CR8E	1862	CR8EIX	490470
KTM						
1050 Adventure	1050	15-16	LKAR9BI-10 LMAR7DI-10	512608 512504	-	-
1090 Adventure	1090	17-	LKAR9BI-10 LMAR7DI-10	512608 512504	-	-
1090 Adventure L	1090	17-	LKAR9BI-10 LMAR7DI-10	512608 512504	-	-
1090 Adventure R	1090	17-	LKAR9BI-10 LMAR7DI-10	512608 512504	-	-
1190	1190	10-	LKAR9BI9 LMAR7A-9	512231 512570	-	-
1190 Adventure	1190	13-16	LKAR9BI9 LMAR7A-9	512231 512570	-	-
1190 Adventure R	1190	13-16	LKAR9BI9 LMAR7A-9	512231 512570	-	-
1190 R	1190	11-	LKAR9BI9 LMAR7A-9	512231 512570	-	-



Modèle	Cylindrée	Année	Bougie			
				Ref CGN standard	Ref CGN iridium	
1190 R Akrapovic Edition	1190	10-	LKAR9BI9 LMAR7A-9	512231 512570	-	-
1190 R Red Bull	1190	10-	LKAR9BI9 LMAR7A-9	512231 512570	-	-
1190 RC8	1190	08-	LKAR9BI9	512531	-	-
1190 RC8 R	1190	10-	LKAR9BI9 LMAR7A-9	512231 512570	-	-
125 Duke	125	98-	BR9ES	1890	BR9EIX	381511
125 Duke	125	13-	LKAR8AI-9	512500	-	-
125 EGS	125	93-	-	-	BR10EIX	381617
125 EGS	125	98-	R6918B-8	512528	-	-
125 Enduro	125	-	B10EG	1870	-	-
125 EXC	125	93-97	-	-	BR10EIX	381617
125 EXC	125	97-00	R6918B-8	512528	-	-
125 EXC	125	01	-	-	BR9EIX	381511
125 EXC	125	02-	-	-	BR9ECMIX	496382
125 EXC Six Days	125	08-	-	-	BR9ECMIX	496382
125 EXE	125	99-	BR8HS	195431	BR8HIX	381492
125 GS	125	-	B8HS	1837	BR8HIX	381492
125 GS	125	-	-	-	BR10EIX	381617
125 LC 2	125	96-00	BR9ES	1890	BR9EIX	381511
125 LC 2	125	00-	BR8HS	195431	BR8HIX	381492
125 MC	125	-	B8HS	1837	BR8HIX	381492
125 MC	125	-	B9EG	1869	-	-
125 MC GP	125	-	B10HS	213883	-	-
125 RC1	125	09-	-	-	BR9ECMIX	496382
125 SM	125	-	BR8HS	195431	BR8HIX	381492
125 Sting	125	98-	BR8ES	1889	BR8EIX	381507
125 Supermoto	125	99-	BR8HS	195431	BR8HIX	381492
125 SX	125	93-95	-	-	BR10EIX	381617
125 SX	125	96-97	BR10EG	198172	-	-
125 SX	125	97-00	R6918B-8	512528	-	-
125 SX	125	01	-	-	BR8EIX	381507
125 SX	125	02	-	-	BR9EIX	381511
125 SX	125	03-	-	-	BR9ECMIX	496382
125 SX	125	08-	-	-	BR9ECMIX	496382
125 TXC	125	-	-	-	BR10EIX	381617
125 XC-W	125	17-	-	-	BR9ECMIX	496382
1290 Super Adventure	1290	15-16	LKAR9BI-10 LMAR7DI-10	512608 512504	-	-
1290 Super Adventure R, S, T	1290	17-	LKAR9BI-10 LMAR7DI-10	512608 512504	-	-
1290 Super Duke R	1290	14-15	LKAR9BI9 LMAR7A-9	512231 512570	-	-
144 SX	144	06-	-	-	BR9ECMIX	496382

MOTEUR

CYCLE

PNEUMATIQUE

ATELIER

ACCESSOIRES

ÉLECTRICITÉ

FILTRATION



FREINAGE

TRANSMISSION



Modèle	Cylindrée	Année	NGK		NGK	
			Bougie	Ref CGN standard	Bougie iridium	Ref CGN iridium
144 SX	150	10-	-	-	BR9ECMIX	496382
150 SX	150	09-	-	-	BR9ECMIX	496382
150 XC	150	10-15	-	-	BR9ECMIX	496382
150 XC-W	150	17-	-	-	BR9ECMIX	496382
175 GS	175	-	B8HS	1837	BR8HIX	381492
175 MC	175	-	B8HS	1837	BR8HIX	381492
175 XC	175	10-	-	-	BR9ECMIX	496382
200 Duke	200	11-	LKAR8A-9	507443	-	-
200 Duke	200	14-	LKAR8AI-9	512500	-	-
200 EGS	200	98-	BR8EG	214162	-	-
200 EGS	200	99-	BR8EG	214162	-	-
200 EXC	200	98-99	BR8EG	214162	-	-
200 EXC	200	99-01	BR9EG	1892	BR9EIX	381511
200 EXC	200	02-	BR8EG	214162	-	-
200 EXC	200	10-	BR8EG	214162	-	-
200 MXC	200	99-	BR8EG	214162	-	-
200 SX	200	03-06	-	-	BR9EIX	381511
200 SX	200	07-	BR8EG	214162	-	-
200 XC-W	200	10-	BR8EG	214162	-	-
250 DXC	250	-	-	-	BR9EIX	381511
250 EGS	250	93-95	-	-	BR9EIX	381511
250 EGS	250	97-99	BR8ECM	496394	BR8ECMIX	512423
250 Enduro	250	-	B10EG	1870	-	-
250 EXC	250	93-95	-	-	BR9EIX	381511
250 EXC	250	96	-	-	BR8EIX	381507
250 EXC	250	97-98	BR8ECM	496394	BR8ECMIX	512423
250 EXC	250	10-17	BR7ES	455372	BR7EIX	497115
250 EXC Enduro Competition	250	03-	BR7ES	455372	BR7EIX	497115
250 EXC E-Starter	250	10-	BR7ES	455372	BR7EIX	497115
250 EXC Racing	250	97-	BR8ECM	496394	BR8ECMIX	512423
250 EXC Racing	250	02	CR8EK	461666	CR8EIX	490470
250 EXC Racing	250	03-	DCPR8E	512442	DCPR8EIX	496403
250 EXC Racing GS	250	03-	DCPR8E	512442	DCPR8EIX	496403
250 EXC Racing Six Days	250	02	CR8EK	461666	CR8EIX	490470
250 EXC Six Days	250	98-01	BR8ECM	496394	BR8ECMIX	512423
250 EXC Six Days	250	10-	BR7ES	455372	BR7EIX	497115
250 EXC-F	250	07-	CR9EKB	496397	CR9EIX	381550
250 EXC-F	250	14-	LMAR9AI-10	512499	-	-
250 EXC-F Six Days	250	10-	CR9EKB	496397	CR9EIX	381550
250 Freeride	250	13-	BR7ES	455372	BR7EIX	497115
250 GS	250	-	B9HS	1838	BR9HIX	1851
250 GS	250	-	-	-	BR9EIX	381511



Modèle	Cylindrée	Année	NOK		NOK	
			Bougie	Ref CGN standard	Bougie iridium	Ref CGN iridium
250 MC	250	-	B9HS	1838	BR9HIX	1851
250 MC	250	-	B9EG	1869	-	-
250 MC GP	250	-	B9HS	1838	BR9HIX	1851
250 MC GP	250	-	B9EG	1869	-	-
250 MX	250	-	-	-	BR9EIX	381511
250 MXC	250	04-	BR7ES	455372	BR7EIX	497115
250 SX	250	93-95	-	-	BR9EIX	381511
250 SX	250	96-97	BR8EG	214162	-	-
250 SX	250	97-04	BR8ECM	496394	BR8ECMIX	512423
250 SX	250	05-	CR9EKB	496397	CR9EIX	381550
250 SX	250	10-	BR8ECM	496394	BR8ECMIX	512423
250 SXC	250	99-	BR8ECM	496394	BR8ECMIX	512423
250 SX-F	250	06-12	CR9EKB	496397	CR9EIX	381550
250 SX-F	250	13-	LMAR9AI-8	512607	-	-
250 SX-F Factory Repl. Musquin Edition	250	10-12	CR9EKB	496397	CR9EIX	381550
250 TXC	250	-	-	-	BR9EIX	381511
250 XC, XC-W	250	10-	BR7ES	455372	BR7EIX	497115
250 XCF-W, Champion 's Edition	250	10-	CR9EKB	496397	CR9EIX	381550
300 DXC	300	90-95	-	-	BR9EIX	381511
300 EGS	300	93-95	-	-	BR9EIX	381511
300 EGS	300	97-	BR8ECM	496394	BR8ECMIX	512423
300 EGS	300	99-	BR8ECM	496394	BR8ECMIX	512423
300 EXC	300	93-95	-	-	BR9EIX	381511
300 EXC	300	96	-	-	BR8EIX	381507
300 EXC	300	97-98	BR8ECM	496394	BR8ECMIX	512423
300 EXC	300	10-17	BR7ES	455372	BR7EIX	497115
300 EXC Enduro Competition	300	03-	BR7ES	455372	BR7EIX	497115
300 EXC Six Days	300	10-17	BR7ES	455372	BR7EIX	497115
300 EXC Sixt Days	300	99-	BR8ECM	496394	BR8ECMIX	512423
300 EXC TPI, TPI Six Days	300	18-	ZGR7GI-13G	512502	-	-
300 GS	300	86-	B10EG	1870	BR10EIX	381617
300 GS	300	90-95	-	-	BR9EIX	381511
300 LC	300	-	B10EG	1870	-	-
300 MX	300	-95	-	-	BR9EIX	381511
300 MXC	300	97-02	BR8ECM	496394	BR8ECMIX	512423
300 MXC	300	03-	BR7ES	455372	BR7EIX	497115
300 SX	300	93-95	-	-	BR9EIX	381511
300 SX	300	99-	BR8ECM	496394	BR8ECMIX	512423
300 TVC	300	-	BR8ECM	496394	BR8ECMIX	512423
300 TXC	300	-95	-	-	BR9EIX	381511
300 XC, XC-W	300	10-	BR7ES	455372	BR7EIX	497115
350 EXC-F	350	11-	LMAR9AI-8	512607	-	-

Modèle	Cylindrée	Année	Bougie	 		
				Ref CGN standard	Bougie iridium	Ref CGN iridium
350 EXC-F Six Days	350	11-	LMAR9AI-8	512607	-	-
350 Freeride	350	12-	LMAR9AI-10	512499	-	-
350 GS	350	-	-	-	BR9EIX	381511
350 LC4 EGS	350	93-	D8EA	1855	DR8EIX	493825
350 LC4 EXC	350	93-	D8EA	1855	DR8EIX	493825
350 MX	350	-	-	-	BR9EIX	381511
350 MX	350	10-	LMAR9AI-8	512607	-	-
350 SX-F	350	11-	LMAR9AI-8	512607	-	-
350 XC-F	350	11-	LMAR9AI-8	512607	-	-
350 XCF-W	350	11-	LMAR9AI-8	512607	-	-
360 EGS	360	97-	BR8ECM	496394	BR8ECMIX	512423
360 EXC	360	97-	BR8ECM	496394	BR8ECMIX	512423
360 MXC	360	97-	BR8ECM	496394	BR8ECMIX	512423
360 SX	360	96-	BR8EG	214162	-	-
360 SX	360	97-	BR8ECM	496394	BR8ECMIX	512423
375 EXC Racing	375	09-	LKAR8A-9	507443	-	-
380 EGS	380	99-	BR8ECM	496394	BR8ECMIX	512423
380 EGS	380	98-	BR8ECM	496394	BR8ECMIX	512423
380 Enduro	380	98-	BR8ECM	496394	BR8ECMIX	512423
380 EXC	380	98-	BR8ECM	496394	BR8ECMIX	512423
380 SX	380	99-	BR8ECM	496394	BR8ECMIX	512423
390 Duke	390	13-	LKAR8A-9	507443	-	-
390 FE	390	10-	LKAR8AI-9	512500	-	-
400 EGS	400	97-	D8EA	1855	DR8EIX	493825
400 EGS	400	93-99	D8EA	1855	DR8EIX	493825
400 EGS LC4	400	93-	D8EA	1855	DR8EIX	493825
400 EGS-E	400	97-99	DR8EA	198225	DR8EIX	493825
400 EGS-E	400	97-	DR8EA	198225	DR8EIX	493825
400 Enduro-E	400	98-	D8EA	1855	DR8EIX	493825
400 EXC	400	10-	LKAR8AI-9	512500	-	-
400 EXC LC4	400	93-	D8EA	1855	DR8EIX	493825
400 EXC Racing	400	99-02	CR8EK	461666	CR8EIX	490470
400 EXC Racing	400	02-	DCPR8E	512442	DCPR8EIX	496403
400 EXC Racing	400	03-	DCPR8E	512442	DCPR8EIX	496403
400 GS	400	-	B9HS	1838	BR9HIX	1851
400 LC4	400	99-02	DR8EA	198225	DR8EIX	493825
400 LC4	400	98-	DR8EA	198225	DR8EIX	493825
400 LC4 Competition	400	98-	DR8EA	198225	DR8EIX	493825
400 LC4- E Enduro	400	01-	DR8EA	198225	DR8EIX	493825
400 LC4-E	400	99-02	DR8EA	198225	DR8EIX	493825
400 LC4-E	400	02-	DCPR8E	512442	DCPR8EIX	496403
400 LES	400	97-99	DR8EA	198225	DR8EIX	493825



Modèle	Cylindrée	Année	Bougie	 		
				Ref CGN standard	Bougie iridium	Ref CGN iridium
400 LS-E	400	97-02	DR8EA	198225	DR8EIX	493825
400 MC	400	-	B9HS	1838	BR9HIX	1851
400 MC GP	400	-	B9HS	1838	BR9HIX	1851
400 SC	400	93-99	D8EA	1855	DR8EIX	493825
400 Super Competition	400	97-	D8EA	1855	DR8EIX	493825
400 SX	400	98-02	D8EA	1855	DR8EIX	493825
400 SX Racing	400	02-	DCPR8E	512442	DCPR8EIX	496403
400 SX Racing	400	99-02	CR8EK	461666	CR8EIX	490470
400 SX Six Days	400	99-02	CR8EK	461666	CR8EIX	490470
400 SXC	400	93-02	D8EA	1855	DR8EIX	493825
400 XC-W	400	10-	LKAR8AI-9	512500	-	-
420	420	-	B9EG	1869	-	-
440 EXC	440	94-	B85EGV	512612	-	-
440 SX	440	94-	B85EGV	512612	-	-
450 EXC	450	08-	LKAR8A-9	507443	-	-
450 EXC Racing	450	03-	DCPR8E	512442	DCPR8EIX	496403
450 EXC Racing GS	450	03-	DCPR8E	512442	DCPR8EIX	496403
450 EXC Six Days	450	10-	LKAR8AI-9	512500	-	-
450 EXC-F	450	17-	LMAR9AI-10	512499	-	-
450 EXC-R	450	07-	LKAR8A-9	507443	-	-
450 FE	450	10-	LKAR8AI-9	512500	-	-
450 FX	450	10-	LKAR8AI-9	512500	-	-
450 MXC Desert Racing	450	03-	DCPR8E	512442	DCPR8EIX	496403
450 MXC GS	450	03-	DCPR8E	512442	DCPR8EIX	496403
450 Rallye Replica	450	14-	CR9EKB	496397	CR9EIX	381550
450 SMR	450	04-07	DCPR8E	512442	DCR8EIX	512422
450 SMR	450	05-	CR9EKB	496397	CR9EIX	381550
450 SMR	450	08-	CR9EKB	496397	CR9EIX	381550
450 SX Racing	450	03-	DCPR8E	512442	DCPR8EIX	496403
450 SX-F	450	07-09	CR9EKB	496397	CR9EIX	381550
450 SX-F	450	10-	CR9EKB	496397	CR9EIX	381550
450 SX-F	450	13-	LKAR8AI-9	512500	-	-
450 SX-F Factory Repl.Nagl Edition	450	10-	CR9EKB	496397	CR9EIX	381550
450 XC-W, XC-W Six Days	450	10-	LKAR8AI-9	512500	-	-
495	495	-	B9EG	1869	-	-
500 4 TGS, TXC	500	-	DP9EA-9	512463	DPR9EIX-9	512585
500 DXC	500	-	B9ES	1844	BR9EIX	381511
500 EXC	500	-	B9ES	1844	BR9EIX	381511
500 EXC-F	500	17-	LMAR9AI-10	512499	-	-
500 GS	500	-	B10EG	1870	-	-
500 GS	500	-	D8EA	1855	DR8EIX	493825
500 MC	500	-	B10EG	1870	-	-

MOTEUR

CYCLE

PNEUMATIQUE

ATELIER

ACCESSOIRES

ÉLECTRICITÉ

FILTRATION



FREINAGE

TRANSMISSION

Modèle	Cylindrée	Année	NGK		NGK	
			Bougie	Ref CGN standard	Bougie iridium	Ref CGN iridium
500 MC	500	-	D8EA	1855	DR8EIX	493825
500 MX	500	-	-	-	BR9EIX	381511
500 SX	500	93-	B10ES	213879	BRI0EIX	381617
505 SX-F	477	07-	CR9EKB	496397	CR9EIX	381550
510 EXC Racing	510	08-	LKAR8A-9	507443	-	-
520 EXC Racing	520	02-	DCPR8E	512442	DCPR8EIX	496403
520 EXC Racing, Six Days / SX Racing	520	99-02	CR8EK	461666	CR8EIX	490470
520 EXC-R	530	07-	LKAR8A-9	507443	-	-
520 SX Racing	520	02-	DCPR8E	512442	DCPR8EIX	496403
525 EXC Racing	525	03-	DCPR8E	512442	DCPR8EIX	496403
525 EXC Racing GS	525	03-	DCPR8E	512442	DCPR8EIX	496403
525 MXC	525	03-	DCPR8E	512442	DCPR8EIX	496403
525 MXC Desert Racing	525	05-	DCPR8E	512442	DCPR8EIX	496403
525 SMR	525	05-	DCPR8E	512442	DCPR8EIX	496403
525 SX Racing	525	03-	DCPR8E	512442	DCPR8EIX	496403
525 XC Desert Racing	510	07	DCPR8E	512442	DCPR8EIX	496403
530 EXC	530	08-09	LKAR8A-9	507443	-	-
530 EXC, Six Days / XC-W, Six Days	530	10-	LKAR8AI-9	512500	-	-
540 DXC	540	-	-	-	BRI0EIX	381617
540 MX	540	-	B9ES	1844	BR9EIX	381511
540 SXC	540	98-	D8EA	1855	DR8EIX	493825
540 SXS Racing	540	02-	CR8EK	461666	CR8EIX	490470
560 SMR	565	07-	DCPR8E	512442	DCPR8EIX	496403
570 FE, FS	570	10-	LKAR8AI-9	512500	-	-
600 4 TGS	600	-	DP9EA-9	512463	DPR9EIX-9	512585
600 4 TMX	600	-	DP9EA-9	512463	DPR9EIX-9	512585
600 4 TXC	600	-	DP9EA-9	512463	DPR9EIX-9	512585
600 Country	600	-	D8EA	1855	DR8EIX	493825
600 EGS LC4	600	93-	D8EA	1855	DR8EIX	493825
600 Enduro	600	-	D8EA	1855	DR8EIX	493825
600 EXC LC4	600	93-	D8EA	1855	DR8EIX	493825
600 MX	600	-	D8EA	1855	DR8EIX	493825
612 EGS LC4 / EXC LC4	612	93-	D8EA	1855	DR8EIX	493825
619 LC4 Rallye	620	97-	D8EA	1855	DR8EIX	493825
620 Duke	609	94-	D8EA	1855	DR8EIX	493825
620 Duke-E / EGS-E	620	97-	DR8EA	198225	DR8EIX	493825
620 EGS	620	97-	D8EA	1855	DR8EIX	493825
620 LC4 620 EGS	620	94-	D8EA	1855	DR8EIX	493825
620 LC4 620 EGS-E	620	99-	DPR8EA-9	1857	DPR8EIX-9	496388
620 LC4 620 EXC	620	94-	D8EA	1855	DR8EIX	493825
620 LC4 620 LES	620	99-	DPR8EA-9	1857	DPR8EIX-9	496388
620 LC4 620 SX	620	94-	D8EA	1855	DR8EIX	493825





Modèle	Cylindrée	Année	Bougie		
				Ref CGN standard	Ref CGN iridium
620 LC4 Rallye	620	99-	DPR8EA-9	1857	496388
620 LC4 Super Competition	620	00-02	DPR8EA-9	1857	496388
620 LC4 Super Competition	609	01-02	DR8EA	198225	493825
620 LC4 Super Competition Supermoto	620	02-	DCPR8E	512442	496403
620 LS-E	620	97-	DR8EA	198225	493825
620 SC	620	96-	D8EA	1855	493825
620 SC	620	98-	D8EA	1855	493825
620 SC Supermoto LC4	609	01-02	DR8EA	198225	493825
620 Super Competition	620	97-02	D8EA	1855	493825
620 Supermoto Competition	620	98-00	D8EA	1855	493825
620 SX	620	96-	D8EA	1855	493825
620 SX	620	99-	D8EA	1855	493825
625 SC	625	02-	DPR8EA-9	1857	496388
625 SC Enduro	625	00-	DCPR8E	512442	496403
625 SC Super Moto	625	00-	DCPR8E	512442	496403
625 SMC	625	05-	DCPR8E	512442	496403
625 SXC Hard Enduro	625	03-	DCPR8E	512442	496403
625 SXC Super Moto	625	02-	DCPR8E	512442	496403
640 Adventure R	640	98-01	DR8EA	198225	493825
640 Duke	640	98-01	DR8EA	198225	493825
640 Duke	640	05-	DCPR8E	512442	496403
640 Duke 2	640	02	DPR8EA-9	1857	496388
640 Duke II LC4	640	03-	DCPR8E	512442	496403
640 Hard Enduro LC4	640	03-	DCPR8E	512442	496403
640 LC4	640	02	DPR8EA-9	1857	496388
640 LC4	640	98-99	DR8EA	198225	493825
640 LC4	640	99-01	DR8EA	198225	493825
640 LC4 Adventure	640	00	DPR8EA-9	1857	496388
640 LC4 Adventure	640	01-02	DPR8EA-9	1857	496388
640 LC4 Adventure	640	02	DPR8EA-9	1857	496388
640 LC4 Adventure R	640	99-	D8EA	1855	493825
640 LC4 Adventure R	640	00-	DPR8EA-9	1857	496388
640 LC4 Adventure R	640	02-	DCPR8E	512442	496403
640 LC4 Prestige Supermoto	640	03-	DCPR8E	512442	496403
640 LC4 Rallye	640	98-	D8EA	1855	493825
640 LC4 SM	640	05-	DCPR8E	512442	496403
640 LC4 SM	640	05-	DCPR8E	512442	496403
640 LC4 Supermoto	640	02	DPR8EA-9	1857	496388
640 LC4-E	640	02-	DCPR8E	512442	496403
640 LC4-E	640	00	DPR8EA-9	1857	496388
640 LC4-E Enduro	640	01	DR8EA	198225	493825
640 LC4-E Six Days	640	02	DPR8EA-9	1857	496388

Modèle	Cylindrée	Année	Bougie	 		
				Ref CGN standard	Bougie iridium	Ref CGN iridium
640 LC4-E SM Prestige	640	02	DPR8EA-9	1857	DPR8EIX-9	496388
640 LC4-E Supermoto	640	01	DR8EA	198225	DR8EIX	493825
640 LC4-E Supermoto	640	02	DCPR8E	512442	DCPR8EIX	496403
640 LC4-E Supermoto	640	99-	D8EA	1855	DR8EIX	493825
640 LC4-E Supermoto	640	00	DPR8EA-9	1857	DPR8EIX-9	496388
640 Supermoto Spezial Edition	640	03-	DCPR8E	512442	DCPR8EIX	496403
660 LC4	660	03-	DR9EA	214048	DR9EIX	512583
660 LC4 Enduro	660	08-	LKAR8A-9	507443	-	-
660 LC4 Rallye	660	99-01	DR8EA	198225	DR8EIX	493825
660 LC4 Rallye Replica	660	08-	LKAR8A-9	507443	-	-
660 Rallye	660	00-01	DPR8EA-9	1857	DPR8EIX-9	496388
660 Rallye	660	02	DR9EA	214048	DR9EIX	512583
660 SMC	660	03-	DCPR8E	512442	DCPR8EIX	496403
660 SMC	660	05-	DCPR8E	512442	DCPR8EIX	496403
660 SMC	660	07-	LKAR8AI-9	512500	-	-
660 Supermoto Factory Replica	660	02-	DR9EA	214048	DR9EIX	512583
690 Duke	690	10-11	LKAR8AI-9	512500	-	-
690 Duke	690	12-15	LKAR8BI9 LMAR7A-9	512530 512570	-	-
690 Duke	690	16-	LKAR9BI-10 LMAR7DI-10	512608 512504	-	-
690 Duke III LC4	690	08-09	LKAR8A-9	507443	-	-
690 Duke R	690	10-11	LKAR8AI-9	512500	-	-
690 Duke R	690	12-15	LKAR8BI9 LMAR7A-9	512530 512570	-	-
690 Duke R	690	16	LKAR9BI-10 LMAR7DI-10	512608 512504	-	-
690 Enduro	690	09-13	LKAR8AI-9	512500	-	-
690 Enduro R	690	08-	LKAR8AI-9	512500	-	-
690 Enduro R	690	10-	LKAR8AI-9	512500	-	-
690 Enduro R	690	14-	LKAR8BI9 LMAR7A-9	512530 512570	-	-
690 EXC	690	07-11	LKAR8A-9	507443	-	-
690 LC4 Prestige	660	07-	LKAR8AI-9	512500	-	-
690 LC4 Supermoto	690	07-	LKAR8AI-9	512500	-	-
690 LC4 Supermoto	660	07-	LKAR8AI-9	512500	-	-
690 SM	690	07-	LKAR8AI-9	512500	-	-
690 SM	690	-	LKAR8AI-9	512500	-	-
690 SMC	690	10-	LKAR8AI-9	512500	-	-
690 SMC R Supermoto	690	12-13	LKAR8AI-9	512500	-	-
690 SMC R Supermoto	690	14-	LKAR9BI9 LMAR7A-9	512231 512570	-	-
790 Duke	790	18-	LMAR9AI-10	512499	-	-
950 Adventure	950	03-04	CR8EK	461666	CR8EIX	490470
950 Adventure	950	04-	CR8EK	461666	CR8EIX	490470



Modèle	Cylindrée	Année	Bougie	NOK		
				Ref CGN standard	Ref CGN iridium	
950 Adventure S	950	03-04	CR8EK	461666	CR8EIX 490470	
950 Adventure S	950	04-	CR8EK	461666	CR8EIX 490470	
950 Enduro	950	06-	CR8EK	461666	CR8EIX 490470	
950 LC8 EFI V2	950	09-	KR8DI	512529	-	
950 LC8 Rally	950	03-07	CR8EK	461666	CR8EIX 490470	
950 Super Enduro R	950	-	CR8EK	461666	CR8EIX 490470	
950 Super Enduro R LC8	950	06-	CR8EK	461666	CR8EIX 490470	
950 Supermoto	950	05-06	CR8EK	461666	CR8EIX 490470	
950 Supermoto LC8	950	05-	CR8EK	461666	CR8EIX 490470	
950 Supermoto R	950	07-	CR8EK	461666	CR8EIX 490470	
990 Adventure	1000	08-	LKAR8BI9	512530	-	
990 Adventure	1000	06-09	DCPR8E	512442	DCPR8EIX 496403	
990 Adventure R	1000	08-	LKAR8BI9	512530	-	
990 Adventure S	1000	06-09	DCPR8E	512442	DCPR8EIX 496403	
990 Duke	1000	04-09	DCPR8E	512442	DCPR8EIX 496403	
990 LC8 Adventure	1000	06-08	DCPR8E	512442	DCPR8EIX 496403	
990 LC8 Adventure	1000	08-	LKAR8BI9	512530	-	
990 SM-R	1000	09	KR8DI	512529	-	
990 SM-R	1000	12-	LKAR8BI9	512530	-	
990 SM-T	1000	09-10	KR8DI	512529	-	
990 SM-T ABS	1000	11-13	LKAR8BI9	512530	-	
990 Super Duke	990	10-	KR8DI	512529	-	
990 Super Duke	1000	05-06	DCPR8E	512442	DCPR8EIX 496403	
990 Super Duke	1000	07-09	KR8DI	512529	-	
990 Super Duke R	990	10-	LKAR8AI-9	512500	-	
990 Super Duke R	990	-	DCPR8E	512442	DCPR8EIX 496403	
990 Superduke R LC8	1000	08-	LKAR8AI-9	512500	-	
990 Supermoto LC8	1000	08-	KR8DI	512529	-	
990 Supermoto R	990	10-	KR8DI	512529	-	
990 Supermoto R	1000	09-	KR8DI	512529	-	
990 Supermoto T	990	10-	KR8DI	512529	-	
Duke	640	05-	DCPR8E	512442	DCPR8EIX 496403	
Duke II	640	99-00	DR8EA	198225	DR8EIX 493825	
Duke II	640	00-02	DPR8EA-9	1857	DPR8EIX-9 496388	
Duke II	640	02-	DCPR8E	512442	DCPR8EIX 496403	
Super Duke 1290 GT	1290	16-	LKAR9BI-10 LMAR7DI-10	512608 512504	-	
Super Duke 1290 R Special Edition	1290	16	LKAR9BI9 LMAR7A-9	512231 512570	-	
KYMCO						
Agility 125, R16, RS	125	05-	CR7HSA	1861	CR7HIX 496398	
Agility 150 R16	150	08-	CR7HSA	1861	CR7HIX 496398	
Calypso 125	125	97-	C7HSA	465600	CR7HIX 496398	

Modèle	Cylindrée	Année	Bougie	 		
				Ref CGN standard	Bougie iridium	Ref CGN iridium
CK 125	125	04-	DR8EA	198225	DR8EIX	493825
CK 125	125	05-	DR8EA	198225	DR8EIX	493825
Cruiser 125	125	-	CR8E	1862	CR8EIX	490470
Dink 125 4T, DD	125	99-	DPR7EA-9	198282	DPR7EIX-9	512580
Dink 200 i DD	200	08-	DPR6EA-9	490471	-	-
Dink 250 4T	250	99-	DPR7EA-9	198282	DPR7EIX-9	512580
Dink Street	300	-	CR7E	213902	CR7EIX	490469
Dink Street 125	125	-	CR7E	213902	CR7EIX	490469
Downtown 125 i	125	09-	CR7E	213902	CR7EIX	490469
Downtown 200i	200	09-	CR7E	213902	CR7EIX	490469
Downtown 300i	300	09-	CR7E	213902	CR7EIX	490469
Ego 125	125	00-	DPR7EA-9	198282	DPR7EIX-9	512580
Ego 250	250	00-	DPR7EA-9	198282	DPR7EIX-9	512580
G-Dink 125	125	12-	DPR6EA-9	490471	-	-
Grand Dink	125	01-	DPR7EA-9	198282	DPR7EIX-9	512580
Grand Dink 125 4T	125	99-	DPR7EA-9	198282	DPR7EIX-9	512580
Grand Dink 125 S	125	-	DPR7EA-9	198282	DPR7EIX-9	512580
Grand Dink 250	250	01-	DPR7EA-9	198282	DPR7EIX-9	512580
Grand Dink 250 4T	250	99-	DPR7EA-9	198282	DPR7EIX-9	512580
Grand Dink 300i	300	12-	DPR6EA-9	490471	-	-
Heroism 125	125	-	C7HSA	465600	CR7HIX	496398
Heroism 150	150	95-	C7HSA	465600	CR7HIX	496398
Hipster 125	125	-	CR8E	1862	CR8EIX	490470
Hipster 125	125	01-	DR8EA	198225	DR8EIX	493825
Hipster 125	125	-	DR8EA	198225	DR8EIX	493825
Hipster 125	125	01-	CR8E	1862	CR8EIX	490470
K-Pipe 125 E3	125	12-	CR7HSA	1861	CR7HIX	496398
K-XCT 125i	125	13-	CR7E	213902	CR7EIX	490469
K-XCT 300i	300	12-	CR7E	213902	CR7EIX	490469
Like 125	125	09-	CR7HSA	1861	CR7HIX	496398
Like 200 i	200	09-	CR7HSA	1861	CR7HIX	496398
Like LX 125 E3	125	12-	CR7HSA	1861	CR7HIX	496398
Météorit	125	-	DR8EA	198225	DR8EIX	493825
Movie 125 4T	125	-	C7HSA	465600	CR7HIX	496398
Movie 125 XL	125	02-	CR7HSA	1861	CR7HIX	496398
My Road 700i	700	12-	CR8E	1862	CR8EIX	490470
Off Road / On Road	125	99-	DR8EA	198225	DR8EIX	493825
People 125	125	05-	C7HSA	465600	CR7HIX	496398
People 125 E3	125	08-	CR7HSA	1861	CR7HIX	496398
People 125 GTi	125	10-	CR7HSA	1861	CR7HIX	496398
People 150	150	99-	DPR7EA-9	198282	DPR7EIX-9	512580
People 250	250	03-	DPR7EA-9	198282	DPR7EIX-9	512580



Modèle	Cylindrée	Année	Bougie		
				Ref CGN standard	Ref CGN iridium
People 250	250	05-	DPR7EA-9	198282	512580
People GT 200i	200	10-	CR7E	213902	490469
People GT 300i	300	10-	CR7E	213902	490469
People One 125i	125	13-	CR7E	213902	490469
People S 125 DD	125	08-	CR7HSA	1861	496398
People S 125i	125	05-	CR7HSA	1861	496398
People S 200 DD, S 200i	200	07-	CR7HSA	1861	496398
People S 200i	200	07-	CR7HSA	1861	496398
People S 250i	250	07-	DPR6EA-9	490471	-
People S 300i	300	07-	DPR6EA-9	490471	-
People S 300i	300	08-	DPR6EA-9	490471	-
Pulsar 125	125	01-	DR8EA	198225	493825
Pulsar 125 4T	125	01-	DR8EA	198225	493825
Quannon 125	125	07-	CR8E	1862	490470
Quannon 125 Naked	125	10-	CR8E	1862	490470
Sector 125	125	98-	DR8EA	198225	493825
Spacer 125	125	97-	DPR7EA-9	198282	512580
Spacer 125	125	-	DPR7EA-9	198282	512580
Stryker 125	125	99-	DR8EA	198225	493825
Stryker 125 II	125	02-	DR8EA	198225	493825
Super 8 125	125	07-08	CR7HSA	1861	496398
Super 8 125	125	08-12	CR7HSA	1861	496398
Super 8 125	125	07-	DPR7EA-9	198282	512580
Super 8 125	125	-	CR7HSA	1861	496398
Venox 250 4T	250	01-	DPR7EA-9	198282	512580
Venox 250 4T	250	02-	CR8E	1862	490470
Vivio	125	99-	CR7HSA	1861	496398
Xciting 250	250	05-	DPR7EA-9	198282	512580
Xciting 250i	250	07-	DPR6EA-9	490471	-
Xciting 300 R	300	-	CPR6EA-9	512474	512427
Xciting 300i R	300	09-	DPR6EA-9	490471	-
Xciting 400i	400	13-	CR7E	213902	490469
Xciting 500	500	05-	CR8E	1862	490470
Xciting 500i R	500	09-	CR7E	213902	490469
Xciting 500i R	500	07-	CR7E	213902	490469
Xciting 500i, 500i ABS	500	07-	CR7E	213902	490469
Yager 125 4T	125	01-	DPR7EA-9	198282	512580
Yager GT 125	125	07-	DPR7EA-9	198282	512580
Yager GT 200i	200	07-	DPR6EA-9	490471	-
Zing 125	125	97-98	DR8EA	198225	493825
Zing 125	125	99-	DR8EA	198225	493825
Zing II	125	08-	CR8E	1862	490470



Modèle	Cylindrée	Année	Bougie	Ref CGN standard	Bougie iridium	Ref CGN iridium
KYMCO - SSV						
UXV	500	08-	DPR7EA-9	198282	DPR7EIX-9	512580
UXV	500	-	CR7E	213902	CR7EIX	490469
LAVERDA						
1000 RGS	1000	-	B8ES	1843	BR8EIX	381507
1000 SFC	1000	04	B9ES	1844	BR9EIX	381511
650 American Eagle	650	94-98	B9ES	1844	BR9EIX	381511
650 Formula	650	96-	DCPR8E	512442	DCPR8EIX	496403
650 Ghost, Legend, Strike	650	96-98	DCPR9E	213989	DCPR9EIX	512581
650 GT, GTL	650	94-98	B9ES	1844	BR9EIX	381511
650 Sport	650	94-95	DCPR9E	213989	DCPR9EIX	512581
668	668	96-98	DCPR9E	213989	DCPR9EIX	512581
750 American Eagle	750	-	B8ES	1843	BR8EIX	381507
750 Black Strike	750	00-	DCPR8E	512442	DCPR8EIX	496403
750 Diamant	750	97-	DCPR8E	512442	DCPR8EIX	496403
750 Formula S	750	98-00	DCPR9E	213989	DCPR9EIX	512581
750 Ghost	750	98-	DCPR8E	512442	DCPR8EIX	496403
750 GTL	750	-	B8ES	1843	BR8EIX	381507
750 S	750	97-	DCPR8E	512442	DCPR8EIX	496403
750 Sport	750	98-	DCPR8E	512442	DCPR8EIX	496403
750 SS	750	00-	DCPR8E	512442	DCPR8EIX	496403
750 Strike	750	98-	DCPR8E	512442	DCPR8EIX	496403
770 GTL	750	-	BPR7ES	1848	BPR7EIX	512582
LINGBEN						
Manhattan	125	06-	CR7HSA	1861	CR7HIX	496398
MAICO						
250	250	94-	B9ES	1844	BR9EIX	381511
320	320	94-	B9ES	1844	BR9EIX	381511
685 Gespann	685	94-	-	-	BR10EIX	381617
Cross MC 125-490 / Enduro GS 125-490	-	71-97	-	-	BR9EIX	381511
GM Star 250, E 250 / GS 250	250	-	B9ES	1844	BR9EIX	381511
GS 125	125	-	B9ES	1844	BR9EIX	381511
GS 500	500	-	B9ES	1844	BR9EIX	381511
GS Star 500	500	-	B9ES	1844	BR9EIX	381511
GS Star E 500	500	-	B9ES	1844	BR9EIX	381511
M1 Blizzard	250	-	-	-	BR7HIX	497113
M125	125	-	-	-	BR6HIX	497114
M126	125	-	-	-	BR6HIX	497114
M150	150	-	-	-	BR6HIX	497114
M151	150	-	-	-	BR6HIX	497114
M175	175	-	-	-	BR7HIX	497113
M175 SS	175	-	-	-	BR9HIX	1851



Modèle	Cylindrée	Année	NOK		NOK	
			Bougie	Ref CGN standard	Bougie iridium	Ref CGN iridium
M 200	200	-	-	-	BR7HIX	497113
M 250	250	-	-	-	BR8HIX	381492
M 250 2 Blizzard	250	-	-	-	BR8HIX	381492
M 250 B	250	-	-	-	BR8HIX	381492
M 250 M Military	250	-	-	-	BR9EIX	381511
M 250 S	250	-	-	-	BR8HIX	381492
M 250 SS	250	-	-	-	BR9HIX	1851
M 277	277	-	-	-	BR8HIX	381492
Macomobil MB 150	150	-	-	-	BR7HIX	497113
Macomobil MB 2000	200	-	-	-	BR7HIX	497113
Maicoletta 175	175	-	-	-	BR8HIX	381492
Maicoletta 250	250	-	-	-	BR8HIX	381492
Maicoletta 277	277	-	-	-	BR8HIX	381492
MC 125	125	-	B9ES	1844	BR9EIX	381511
MC 250	250	-	B9ES	1844	BR9EIX	381511
MC 400	400	-	B9ES	1844	BR9EIX	381511
MC 440	440	94-	B9ES	1844	BR9EIX	381511
MC 500	500	94-	B9ES	1844	BR9EIX	381511
MC 500	500	-	B9ES	1844	BR9EIX	381511
MD 125	125	-	-	-	BR9HIX	1851
MD 250, 250 wk	250	-	-	-	BR9EIX	381511
Modèles culot court	-	-	-	-	BR9HIX	1851
SG 125	125	-	B9ES	1844	BR9EIX	381511
Taifun 350	350	-	-	-	BR8HIX	381492
Taifun 400	400	-	-	-	BR8HIX	381492
MALAGUTI						
Blog 125	125	09-	DPR7EA-9	198282	DPR7EIX-9	512580
Blog 160 / Centro 160	160	-	DPR7EA-9	198282	DPR7EIX-9	512580
Centro 125	125	-	DPR7EA-9	198282	DPR7EIX-9	512580
Centro 125 SL	125	10-	DPR7EA-9	198282	DPR7EIX-9	512580
Centro 160 SL	160	10-	DPR7EA-9	198282	DPR7EIX-9	512580
Ciak 125	125	01-04	CR7HSA	1861	CR7HIX	496398
Ciak 150	150	-	CR7HSA	1861	CR7HIX	496398
F-12 Phantom Max 200	200	04-	CR8EB	384085	CR8EIX	490470
F-18 Warrior 125	125	-	DPR7EA-9	198282	DPR7EIX-9	512580
F-18 Warrior 150	150	01-	DPR7EA-9	198282	DPR7EIX-9	512580
Madison 125, 125 E2	125	-	CR8E	1862	CR8EIX	490470
Madison 150	150	-	CR8E	1862	CR8EIX	490470
Madison 180	180	-01	CR9EB	328861	CR9EIX	381550
Madison 180	180	01-	CR8EB	384085	CR8EIX	490470
Madison 250	250	99-04	DPR9EA-9	1860	DPR9EIX-9	512585
Madison 3	125	-	CR8EB	384085	CR8EIX	490470

MOTEUR

CYCLE

PNEUMATIQUE

ATELIER



ACCESSOIRES

ÉLECTRICITÉ



FILTRATION



FREINAGE

TRANSMISSION

Modèle	Cylindrée	Année	Bougie	 		
				Ref CGN standard	Bougie iridium	Ref CGN iridium
Madison 3 250	250	-	PMR8B	512439	-	-
Madison 400	400	02-	CR7E	213902	CR7EIX	490469
Madison 400	400	03-	CR9E	1863	CR9EIX	381550
Madison S 200	200	03-	CR8EB	384085	CR8EIX	490470
Madison S 250	250	-	DR8EA	198225	DR8EIX	493825
Password 250	250	-	DPR8EA-9	1857	DPR8EIX-9	496388
Runner 125 Rally	125	-	B9ES	1844	BR9EIX	381511
Runner 125 YLC	125	-	B8ES	1843	BR8EIX	381507
Spidermax GT 500	500	04-	CR7EKB	450805	CR7EIX	490469
Spidermax RS 500	500	10-	CR7EKB	450805	CR7EIX	490469
X3M Enduro 125	125	08-	CR7HSA	1861	CR7HIX	496398
X3M Motard 125	125	08-	CR7HSA	1861	CR7HIX	496398
MBK						
125	125	-	B8HS	1837	BR8HIX	381492
125	125	-	B8ES	1843	BR8EIX	381507
350 E, Injection	350	-	B8ES	1843	BR8EIX	381507
Active	125	-95	CR6HSA	213898	CR6HIX	512424
Doodo	125	-	CR8E	1862	CR8EIX	490470
Kilibre 300	300	03-	DR8EA	198225	DR8EIX	493825
Skycruiser 125	125	06-	CPR9EA-9	465889	CPR9EAIX-9	512434
Skyliner	125	98-	CR8E	1862	CR8EIX	490470
Skyliner 180	180	03-	CR8E	1862	CR8EIX	490470
Skyliner 250	250	-	B8ES	1843	BR8EIX	381507
Skyliner 400	400	04-	CR7E	213902	CR7EIX	490469
Thunder 125	125	-	CR8E	1862	CR8EIX	490470
Vertex 150	150	-	CR7E	213902	CR7EIX	490469
XC 125 Flame F	125	00-03	CR7E	213902	CR7EIX	490469
XC 125 Flame R	125	96-99	CR7E	213902	CR7EIX	490469
XC 125 Flame T	125	95-00	CR7E	213902	CR7EIX	490469
XC 125 X Flame X	125	04-06	CR7E	213902	CR7EIX	490469
X-Over	125	10-	CPR9EA-9	465889	CPR9EAIX-9	512434
MONDIAL						
175 SS	175	-	B9HS	1838	BR9HIX	1851
Cross Radial v6	125	-	B7HS	1835	BR7HIX	497113
Piega VTR	1000	03-	FR9BI-11	512489	-	-
MONTESA						
304, 307, 309	260	-	BPR5ES	198191	BPR5EIX	511478
310	250	-	BPR7ES	1848	BPR7EIX	512582
314	260	-	BR6ES	512536	-	-
315R	315	97-	BR6ES	512536	-	-
330	330	-	BPR5ES	198191	BPR5EIX	511478
Cappra 125	125	-	B10ES	213879	BR10EIX	381617





Modèle	Cylindrée	Année	Bougie	 		
				Ref CGN standard	Bougie iridium	Ref CGN iridium
Cappra 125 MX	125	-	B8HS	1837	BR8HIX	381492
Cappra 125 VA, VB, VE, VF	125	-	B10ES	213879	BR10EIX	381617
Cappra 250	250	-	B8HS	1837	BR8HIX	381492
Cappra 250 CA	250	-	B9ES	1844	BR9EIX	381511
Cappra 250 GP, MX	250	-	B8HS	1837	BR8HIX	381492
Cappra 250 VB, VE, VF, VG, VR	250	-	B9ES	1844	BR9EIX	381511
Cappra 360VA, VB	360	-	B8ES	1843	BR8EIX	381507
Cappra 414VE, VF, VG	410	-	B8ES	1843	BR8EIX	381507
Cappra B, E, F, G, R	250	-	B9ES	1844	BR9EIX	381511
Cappra GP	360	-	B8ES	1843	BR8EIX	381507
Cappra MX	250	-	B8HS	1837	BR8HIX	381492
Cappra VA	250	-	B9ES	1844	BR9EIX	381511
Cota 172	175	-	B6ES	1841	-	-
Cota 200	175	-	B6ES	1841	-	-
Cota 242	250	-	BP6ES	490457	BPR6EIX	512415
Cota 247, C, T	250	-	B8HS	1837	BR8HIX	381492
Cota 248	250	-	BP5ES	490456	BPR5EIX	511478
Cota 304, 307	250	-	BPR7ES	1848	BPR7EIX	512582
Cota 309, 310, 310 Evasion	260	-	BPR7ES	1848	BPR7EIX	512582
Cota 311	260	-	BPR5ES	198191	BPR5EIX	511478
Cota 315	250	97-99	BR6ES	512536	-	-
Cota 330	330	-	BP5ES	490456	BPR5EIX	511478
Cota 330 Trial	330	-	BP5ES	490456	BPR5EIX	511478
Cota 335, 335E	350	-	BP5ES	490456	BPR5EIX	511478
Cota 348, 348 Trial	310	-	BP5ES	490456	BPR5EIX	511478
Cota 349, 349T, 350	350	-	BP5ES	490456	BPR5EIX	511478
Cota 4RT	250	05-	CR6EH-9	512476	-	-
Cota 4RT	250	09-	CR6EH-9	512476	-	-
Cota 4RT Repsol	250	09-	CR6EH-9	512476	-	-
Cota Evasion	310	-	BPR7ES	1848	BPR7EIX	512582
Crono 125D	125	-	B8ES	1843	BR8EIX	381507
Crono 350	350	-	B7ES	1842	BR7EIX	497115
Enduro 125	125	-	B8ES	1843	BR8EIX	381507
Enduro 125 H6, H7, L	125	-	B8ES	1843	BR8EIX	381507
Enduro 250 H6	250	-	B8ES	1843	BR8EIX	381507
Enduro 250 H7	250	-	B10EG	1870	-	-
Enduro 360 H6, H7, H7S, L	350	-	B7ES	1842	BR7EIX	497115
Enduro Rapita 250 Automix	250	-	B8ES	1843	BR8EIX	381507
Impala	250	-	B8HS	1837	BR8HIX	381492
Impala 175 Comando, Turismo	175	-	B6HS	1834	BR6HIX	497114
Impala 2	175	-	B7HS	1835	BR7HIX	497113
Impala 2 Sport	175	-	B7HS	1835	BR7HIX	497113

Modèle	Cylindrée	Année	Bougie	 		
				Ref CGN standard	Bougie iridium	Ref CGN iridium
Impala 250 King	250	-	B8HS	1837	BR8HIX	381492
Impala 250 Scorpion	250	-	B8HS	1837	BR8HIX	381492
Impala 250 Sport	250	-	B8HS	1837	BR8HIX	381492
K.Scorpion	250	-	B8HS	1837	BR8HIX	381492
Kenya 175	175	-	B6HS	1834	BR6HIX	497114
MH 123	125	-	BR7ES	455372	BR7EIX	497115
MH 200	200	-	BPR7ES	1848	BPR7EIX	512582
MH 349	349	-	BPR5ES	198191	BPR5EIX	511478
Texas 175	175	-	B6HS	1834	BR6HIX	497114
MOTO GUZZI						
1000	1000	-	BP6ES	490457	BPR6EIX	512415
1000 GT	1000	88-	BP6ES	490457	BPR6EIX	512415
1000 Le Mans	1000	90-	BPR7ES	1848	BPR7EIX	512582
1000 S	1000	89-	BPR7ES	1848	BPR7EIX	512582
1100 Sport	1100	96-	BPR6ES	198187	BPR6EIX	512415
1200 Sport	1200	07-09	BPR6ES PMR8B	198187 512439	-	-
1200 Sport 4V	1200	09-	CR8EKB	496381	-	-
125 Custom	125	86-	B9ES	1844	BR9EIX	381511
750 SP	750	92-	B8ES	1843	BR8EIX	381507
750 Targa	750	92-	B8ES	1843	BR8EIX	381507
Bellagio 940	936	11-	BPR6ES	198187	BPR6EIX	512415
Bellagio 940	940	07-	BPR6ES PMR8B	198187 512439	-	-
Bellagio 940 Aquila Nera	940	10-	BPR6ES PMR8B	198187 512439	-	-
Breva 1100	1100	06-	BPR6ES PMR8B	198187 512439	-	-
Breva 1200	1200	08-	BPR6ES PMR8B	198187 512439	-	-
Breva 750	750	-	BR8ES	1889	BR8EIX	381507
Breva 750 Naked	750	03-	BR8ES	1889	BR8EIX	381507
Breva 750 Touring	750	06-	BR8ES	1889	BR8EIX	381507
Breva 850	877	06-	BPR6ES	198187	BPR6EIX	512415
Breva 850	877	06-	BPR6ES PMR8B	198187 512439	-	-
California	1400	13-	LMAR8F-9	512541	-	-
California 1000 Carbu	1000	94-97	BPR6ES	198187	BPR6EIX	512415
California 1000 I.E.	1000	91-	BPR7ES	1848	BPR7EIX	512582
California 1000 III	1000	88-	BP6ES	490457	BPR6EIX	512415
California 1000 Inj.	1000	94-97	BPR6ES	198187	BPR6EIX	512415
California 1100 Aluminium	1100	03-	BPR6ES	198187	BPR6EIX	512415
California 1100 Aquila Nera	1100	10-	BPR6ES PMR8B	198187 512439	-	-
California 1100 Carb	1100	94-97	BPR6ES	198187	BPR6EIX	512415





Modèle	Cylindrée	Année	Bougie	 		
				Ref CGN standard	Bougie iridium	Ref CGN iridium
California 1100 Classic	1100	07-	BPR6ES PMR8B	198187 512439	-	-
California 1100 EV	1100	97-05	BPR6ES	198187	BPR6EIX	512415
California 1100 Inj	1100	94-97	BPR6ES	198187	BPR6EIX	512415
California 1100 Jackal	1100	99-01	BPR6ES	198187	BPR6EIX	512415
California 1100 KC	1100	94-	BPR6ES	198187	BPR6EIX	512415
California 1100 KD	1100	94-	BPR6ES	198187	BPR6EIX	512415
California 1100 Special	1100	02-	BPR6ES	198187	BPR6EIX	512415
California 1100 Special	1100	94-97	BPR6ES	198187	BPR6EIX	512415
California 1100 Special Sport	1100	02-	BPR6ES	198187	BPR6EIX	512415
California 1100 Stone	1100	-	BPR6ES	198187	BPR6EIX	512415
California 1100 Stone Metal	1100	01-02	BPR6ES	198187	BPR6EIX	512415
California 1100 Stone Touring	1100	03-04	BPR6ES	198187	BPR6EIX	512415
California 1100 Titanium	1100	03-	BPR6ES	198187	BPR6EIX	512415
California 1100 Touring	1100	06	BPR6ES PMR8B	198187 512439	BPR6EIX PMR8B	512415 / 512439
California 1100 Vintage	1100	07-	BPR6ES PMR8B	198187 512439	-	-
California 1100 Vintage 90ième Anniversaire	1100	11-	BPR6ES PMR8B	198187 512439	BPR6EIX PMR8B	512415 / 512439
Daytona 1000	1000	92-	D9EA	214067	DR9EIX	512583
Daytona 1000 Racing	1000	96	D9EA	214067	DR9EIX	512583
Daytona 1000 RS	1000	97-98	DR9EA	214048	DR9EIX	512583
Daytona 1100 RS	1100	96-	DR8EA	198225	DR8EIX	493825
Griso 1100	1100	05-	BPR6ES PMR8B	198187 512439	-	-
Griso 1200 8V	1200	08-	PMR8B	512439	-	-
Griso 1200 8V Special Edition	1200	09-	CR8EKB	496381	-	-
Griso 850	850	06-	BPR6ES	198187	BPR6EIX	512415
Griso 8V 1200 SE	1200	09-	PMR8B	512439	-	-
MGS 01	1250	04-	-	-	DCPR9EIX	512581
MGS Café Sport	1225	04-	D10EA	512540	-	-
Nevada 750 Anniversario	750	12-	CPR8EB-9	490493	-	-
Nevada 750 Aquila Nera	750	10-	BR8ES	1889	BR8EIX	381507
Nevada 750 Base-Club	750	02-03	BR8ES	1889	BR8EIX	381507
Nevada 750 Basic	750	92-	B8ES	1843	BR8EIX	381507
Nevada 750 Classic Anniversario	750	10-11	BR8ES	1889	BR8EIX	381507
Nevada 750 Classic ie	750	04-	BR8ES	1889	BR8EIX	381507
Nevada 750 Club	750	98-01	BR8ES	1889	BR8EIX	381507
Nevada 750 NT	750	94-97	BR8ES	1889	BR8EIX	381507
Nevada Club	350	98-99	BR8ES	1889	BR8EIX	381507
Nevada NT	350	94-97	BR8ES	1889	BR8EIX	381507
Norge 850	877	06-	BPR6ES	198187	BPR6EIX	512415
Norge GT 1200	1200	06-09	BPR6ES PMR8B	198187 512439	-	-



Modèle	Cylindrée	Année	Bougie	 		
				Ref CGN standard	Bougie iridium	Ref CGN iridium
Norge GT 8V	1200	09-	CR8EKB	496381	-	-
Quota 1000	1000	92-	BPR7ES	1848	BPR7EIX	512582
Quota 1000 I.E.	1000	-	BPR8ES	496395	BPR8EIX	512589
Quota 1100	1100	98-	BPR6ES	198187	BPR6EIX	512415
Quota ES	1100	98-02	BPR6ES	198187	BPR6EIX	512415
Quota I.E.	1100	98-02	BPR6ES	198187	BPR6EIX	512415
Sport 1100	1100	94-95	BP6ES	490457	BPR6EIX	512415
Sport 1100	1100	95-	BPR6ES	198187	BPR6EIX	512415
Sport 1100i	1100	96-	BPR6ES	198187	BPR6EIX	512415
Sport 1200 V4	1200	09-	PMR8B	512439	-	-
Stelvio 1200	1200	08-	CR8EKB	496381	-	-
Stelvio 1200 4V	1200	08-	PMR8B	512439	-	-
Stelvio 1200 NTX	1200	09-	CR8EKB	496381	-	-
Stelvio 1200 TT (NTX)	1200	09-	PMR8B	512439	-	-
Stone 1100 Touring	1100	03-	BPR6ES	198187	BPR6EIX	512415
Strada 1000	1000	-	BP6ES	490457	BPR6EIX	512415
T 5 Polizia	1000	92-	BP6ES	490457	BPR6EIX	512415
V 10 Centauro	1000	97-99	DR9EA	214048	DR9EIX	512583
V 10 Centauro	1000	96-	DR9EA	214048	DR9EIX	512583
V 10 Centauro GT	1000	96-	DR9EA	214048	DR9EIX	512583
V 10 Centauro Sport	1000	96-	DR9EA	214048	DR9EIX	512583
V 11	1100	05-	BPR6ES PMR8B	198187 512439	BPR6EIX PMR8B	512415 / 512439
V 11 Ballabio	1100	03-05	BPR6ES	198187	BPR6EIX	512415
V 11 Cafe Sport	1100	03-05	BPR6ES	198187	BPR6EIX	512415
V 11 Coppa Italia	1100	03-04	BPR6ES	198187	BPR6EIX	512415
V 11 Le Mans	1100	-	BPR6ES	198187	BPR6EIX	512415
V 11 Le Mans Nero Corsa	1100	04-	BPR6ES	198187	BPR6EIX	512415
V 11 Naked	1100	03-	BPR6ES	198187	BPR6EIX	512415
V 11 Rosso Mandello	1100	99-	BPR6ES	198187	BPR6EIX	512415
V 11 Scura	1100	03-	BPR6ES	198187	BPR6EIX	512415
V 11 Scura R	1100	04-05	BPR6ES	198187	BPR6EIX	512415
V 11 Sport	1100	99-	BPR6ES	198187	BPR6EIX	512415
V 11 Sport Ballado	1100	03-	BPR6ES	198187	BPR6EIX	512415
V 11 Sport IE	1100	95-99	BPR6ES	198187	BPR6EIX	512415
V 11 Sport IE Corsa	1100	95-99	BPR6ES	198187	BPR6EIX	512415
V 35	350	77-	BPR7ES	1848	BPR7EIX	512582
V 35 III	350	85-	BP8ES	490461	BPR8EIX	512589
V 350 Nevada	350	92-	B8ES	1843	BR8EIX	381507
V 40 Imola	400	-	BP8ES	490461	BPR8EIX	512589
V 65	650	87-	BCPR6ES	485575	BCPR6EIX	512435
V 65 Florida	650	86-	B8ES	1843	BR8EIX	381507
V 65 Polizia NT	650	-	B8ES	1843	BR8EIX	381507



Modèle	Cylindrée	Année	Bougie	 		
				Ref CGN standard	Ref CGN iridium	
V 7	750	12-	CPR8EB-9	490493	-	-
V 7 Café Classic	750	09-	BR8ES	1889	BR8EIX	381507
V 7 Café Racer	750	10-11	BR8ES	1889	BR8EIX	381507
V 7 Café Racer	750	11-	CPR8EB-9	490493	-	-
V 7 Classic	750	08-	BR8ES	1889	BR8EIX	381507
V 7 Racer	750	10-11	BR8ES	1889	BR8EIX	381507
V 7 Racer, Special, Stone	750	12-	CPR8EB-9	490493	-	-
V 75	750	92-	B8ES	1843	BR8EIX	381507
V 75 Nevada, NTX, Polizia NT	750	92-	B8ES	1843	BR8EIX	381507
V 75, 75 Duna	750	-	C8HSA	512537	CR8HIX	504033
V 850	850	-	BP6ES	490457	BPR6EIX	512415
V Brevia 750 i.e	750	04-	BPR6ES	198187	BPR6EIX	512415
MOTO HISPANA						
RYZ	125	-	CR7HSA	1861	CR7HIX	496398
MOTO MORINI						
350 Excalibur	350	92-	BPR7ES	1848	BPR7EIX	512582
400 Dart	400	91-	BP8ES	490461	BPR8EIX	512589
501 Excalibur	500	91-	BP8ES	490461	BPR8EIX	512589
501 Excalibur	501	92-	BPR7ES	1848	BPR7EIX	512582
9½	1187	06-	CR9E	1863	CR9EIX	381550
Corsaro 1200	1200	05-	CR9E	1863	CR9EIX	381550
Maestro	500	81-	BPR7ES	1848	BPR7EIX	512582
MV AGUSTA						
350 B GT	350	-	B8ES	1843	BR8EIX	381507
350 B S	350	-	B8ES	1843	BR8EIX	381507
350 B Scrambler	350	-	B8ES	1843	BR8EIX	381507
350 BE GT	350	-	B8ES	1843	BR8EIX	381507
350 BE GT (216)	350	-	B8ES	1843	BR8EIX	381507
350 BE S	350	-	B8ES	1843	BR8EIX	381507
350 BE Scrambler	350	-	B8ES	1843	BR8EIX	381507
350 BES (216)	350	-	B8ES	1843	BR8EIX	381507
350 GT Electronique	350	-	B8ES	1843	BR8EIX	381507
350 S Electronique	350	-	B8ES	1843	BR8EIX	381507
350 Scrambler Electronique	350	-	B8ES	1843	BR8EIX	381507
4C6	600	-	B8ES	1843	BR8EIX	381507
4C75GT	750	-	B8ES	1843	BR8EIX	381507
4C75S	750	-	B8ES	1843	BR8EIX	381507
750 GT	750	-	B8ES	1843	BR8EIX	381507
750 S	750	-	B8ES	1843	BR8EIX	381507
750 SS	750	-	B8ES	1843	BR8EIX	381507
Brutale 1078 RR	1078	08-	CR9EB	328861	CR9EIX	381550
Brutale 1090 R, RR	1078	10-	CR9EB	328861	CR9EIX	381550

Modèle	Cylindrée	Année	Bougie	 		
				Ref CGN standard	Bougie iridium	Ref CGN iridium
Brutale 1090, R	1090	12-	CR9EB	328861	CR9EIX	381550
Brutale 675	675	12-	CR9EKB	496397	CR9EIX	381550
Brutale 800	800	12-	CR9EIB-9	512542	-	-
Brutale 910 S	910	05-08	CR9EKB	496397	CR9EIX	381550
Brutale 920	921	11-	CR9EB	328861	CR9EIX	381550
Brutale 989 R	989	08-	CR9EB	328861	CR9EIX	381550
Brutale 990 R	998	10-	CR9EB	328861	CR9EIX	381550
Dragster 800	800	13-	CR9EIB-9	512542	-	-
F3 675	675	12-	CR9EKB	496397	CR9EIX	381550
F3 675 RC	675	-	CR9EKB	496397	CR9EIX	381550
F3 675 Serie Oro	675	12-	CR9EKB	496397	CR9EIX	381550
F3 800	800	13-	CR9EIB-9	512542	-	-
F4	750	99-04	R0045Q-10	512443	-	-
F4 1000	1000	13-	CR9EB	328861	CR9EIX	381550
F4 1000 LH44	1000	-	CR9EB	328861	CR9EIX	381550
F4 1000 R	1000	08-	CR9EB	328861	CR9EIX	381550
F4 1000 RC	1000	15-	CR9EB	328861	CR9EIX	381550
F4 1000 RR	1000	12-	CR9EB	328861	CR9EIX	381550
F4 1000 Senna	1000	06-	R0045Q-10	512443	-	-
F4 1000 Tamburini, S	1000	04-	R0045Q-10	512443	-	-
F4 1078 RR	1100	08-	CR9EB	328861	CR9EIX	381550
F4 750 Brutale (oro)	750	99-	CR9EKB	496397	CR9EIX	381550
F4 750 Brutale S	750	02-	CR9EKB	496397	CR9EIX	381550
F4 750 Oro	750	99-	CR9EB	328861	CR9EIX	381550
F4 750 Oro S	750	99-	CR9EB	328861	CR9EIX	381550
F4 750 Oro VIN.n°->300	750	99-	CR9EKB	496397	CR9EIX	381550
F4 750 S1+1 Biposto	750	00-	CR9EB	328861	CR9EIX	381550
F4 750 S American	750	-	B7ES	1842	BR7EIX	497115
F4 750 S SPR	750	99-	CR9EKB	496397	CR9EIX	381550
F4 750 Senna	750	99-	CR9EKB	496397	CR9EIX	381550
F4 Brutale 910	910	05-	CR9EB	328861	CR9EIX	381550
F4 Brutale 910 R	910	06-	CR9EB	328861	CR9EIX	381550
Rivale 800	800	13-	CR9EIB-9	512542	-	-
RVS#1	800	-	CR9EIB-9	512542	-	-
Turismo Veloce 800	800	13-	CR9EIB-9	512542	-	-
MZ						
1000 S	1000	04-	BKUR6ET	512543	BCPR6EIX	512435
1000 SF, ST	1000	05-	BKUR6ET	512543	BCPR6EIX	512435
125 Fun X	125	03-	CR8E	1862	CR8EIX	490470
125 Fun X	125	01-	CR8E	1862	CR8EIX	490470
125 SM	125	01-	CR8E	1862	CR8EIX	490470
125 SX	125	01-	CR8E	1862	CR8EIX	490470



Modèle	Cylindrée	Année	Bougie	 		
				Ref CGN standard	Ref CGN iridium	
125 Younster Cup	125	03-	CR8E	1862	490470	
Baghira	660	97-	DPR9EA-9	1860	512585	
Baghira Black Panther	660	99-	DPR9EA-9	1860	512585	
Baghira Black Panther HR	660	00-	DPR9EA-9	1860	512585	
Baghira Forest	660	99-	DPR9EA-9	1860	512585	
Baghira HR	660	99-	DPR9EA-9	1860	512585	
Baghira Street Moto	660	99-	DPR9EA-9	1860	512585	
Baghira Street Moto HR	660	00-	DPR9EA-9	1860	512585	
Cup Replica 125 SM	125	05-	CR8E	1862	490470	
ETZ 125	125	86-99	B8HS	1837	381492	
ETZ 150	150	86-95	B8HS	1837	381492	
ETZ 301 Classic	301	-	B8HS	1837	381492	
ETZ Classic	251	-	B8HS	1837	381492	
Gangata 125 SM	125	05-	CR8E	1862	490470	
Mastiff	660	97-	DPR9EA-9	1860	512585	
Moskito 125	125	01-	CR7HSA	1861	496398	
MZ500, 500R	500	92-96	D8EA	1855	493825	
Replica 660	660	95-	DPR9EA-9	1860	512585	
RT 125	125	00-	CR8E	1862	490470	
RT 125 Classic	125	03-	CR8E	1862	490470	
RT 125 SM	125	00-	CR8E	1862	490470	
Saxon 251 Fun, Tour	251	-	B8HS	1837	381492	
Saxon 301 Fun	301	-	B8HS	1837	381492	
Saxon 301 Tour	301	-	B8HS	1837	381492	
Saxon 500 Country, Fun, Funkkrad, Tour, Voyager	500	-	D8EA	1855	493825	
Saxon Roadstar, Sportstar	125	-	B8HS	1837	381492	
Saxon Roadstar, Sportstar	150	-	B8HS	1837	381492	
Silver Star Classic 500	500	-	D8EA	1855	493825	
Silver Star Classic 500	500	-	D8EA	1855	493825	
Silver Star Gespann 500	500	95-	D8EA	1855	493825	
Skorpion Cup	660	96-	DPR9EA-9	1860	512585	
Skorpion Replica	660	95-	DPR9EA-9	1860	512585	
Skorpion Sport, Tour	660	94-	DPR9EA-9	1860	512585	
Skorpion Traveller	660	96-	DPR9EA-9	1860	512585	
SM 125	125	01-	CR8E	1862	490470	
Striker 125 RT	125	05-	CR8E	1862	490470	
Supermoto 125	125	05-	CR8E	1862	490470	
Supermoto 660	660	05-	DPR9EA-9	1860	512585	
SX 125	125	02-	CR8E	1862	490470	
Twin Colour 125 SM	125	06-	CR8E	1862	490470	
MZ KANUNI						
Classic	125	97-	B8HS	1837	381492	

MOTEUR

CYCLE

PNEUMATIQUE

ATELIER



ACCESSOIRES

ÉLECTRICITÉ

FILTRATION

FREINAGE

TRANSMISSION

Modèle	Cylindrée	Année	Bougie	 		
				Ref CGN standard	Bougie iridium	Ref CGN iridium
Kanuni	300	97-	B8HS	1837	BR8HIX	381492
P.G.O.						
G-Max 125	125	05-	C7HSA	465600	CR7HIX	496398
G-Max 125	125	05-	CR7HSA	1861	CR7HIX	496398
G-Max 250	250	05-07	DPR7EA-9	198282	DPR7EIX-9	512580
Libra, Ligero 125	125	08-	C7HSA	465600	CR7HIX	496398
Tornado 1.25	125	97-	BPR7HS	1887	BPR7HIX	497112
T-REX 125 2T	125	99-	BP7HS	490460	BPR7HIX	497112
T-REX 125 4T	125	99-	C7HSA	465600	CR7HIX	496398
T-REX 150 4T	150	03-	C7HSA	465600	CR7HIX	496398
PEUGEOT MOTORCYCLES						
176	175	-	B6HS	1834	BR6HIX	497114
176 BB	175	-	B6HS	1834	BR6HIX	497114
176 Grand Sport	175	-	B8ES	1843	BR8EIX	381507
176 TC	175	-	B6HS	1834	BR6HIX	497114
256	250	-	B7HS	1835	BR7HIX	497113
55 D 125	125	-	B6HS	1834	BR6HIX	497114
550 125	125	-	B6HS	1834	BR6HIX	497114
Atlantis 125	125	-	B6HS	1834	BR6HIX	497114
Black Sat 125 Compressor	125	06-	CR9EB	328861	CR9EIX	381550
Citystar 125	125	08-	CR9EB	328861	CR9EIX	381550
Citystar 200i	200	12-	CR8EB	384085	CR8EIX	490470
Elyséo 125	125	04-	CR7E	213902	CR7EIX	490469
Elyséo 125	125	11-	CR8EB	384085	CR8EIX	490470
Elyseo 125 Advantage	125	99-	CR7E	213902	CR7EIX	490469
Elyséo 125 Advantage	125	98-	CR8E	1862	CR8EIX	490470
Elyséo 150	150	01-	CR8E	1862	CR8EIX	490470
Elystar 125	125	04-	CR8E	1862	CR8EIX	490470
Elystar 125 Advantage	125	02-	CR7EB	450804	CR7EIX	490469
Elystar 125 Injection	125	04-	CR7EB	450804	CR7EIX	490469
Elystar 150, Looxor 150	150	03-	CR7EB	450804	CR7EIX	490469
Elystar 250, Geopolis 250	250	06-	PMR8B	512439	-	-
F 125 Looxor	125	05-11	CR7EB	450804	CR7EIX	490469
Geopolis 125	125	08-	CR8EB	384085	CR8EIX	490470
Geopolis 125 RS	125	02-	CR7EB	450804	CR7EIX	490469
Geopolis 250 Executive	250	07-	CR9EB	328861	CR9EIX	381550
Geopolis 250 RS	250	08-	PMR8B	512439	-	-
Geopolis 300	300	10-	CR7EKB	450805	CR7EIX	490469
Géopolis 300 RS	300	12-	CR7EKB	450805	CR7EIX	490469
Geopolis 400, 400 RS	400	07-	CR7EKB	450805	CR7EIX	490469
Geopolis 500	500	08-	CR7EKB	450805	CR7EIX	490469
Jet Force 125	125	06-	CR9EB	328861	CR9EIX	381550



Modèle	Cylindrée	Année	NOK		NOK	
			Bougie	Ref CGN standard	Bougie iridium	Ref CGN iridium
Jet Force 125 Compressor	125	03-	CR7EB	450804	CR7EIX	490469
Jet Force 125 Compressor K	125	05-	CR8EK	461666	CR8EIX	490470
Liberty 125	125	05-	CR8EKB	496381	CR8EIX	490470
Looxor 125	125	03-	CR7EB	450804	CR7EIX	490469
Ludix 125	125	-	CR7EB	450804	CR7EIX	490469
LXR 125	125	04-	CR9EB	328861	CR9EIX	381550
LXR 200	200	09-	CR7E	213902	CR7EIX	490469
Metropolis 400i, 400i RS	400	13-	CPR8EB-9	490493	-	-
P 150	150	-	B6HS	1834	BR6HIX	497114
P 155, P156	155	-	B6HS	1834	BR6HIX	497114
Satelis 125	125	03-08	CR9EB	328861	CR9EIX	381550
Satelis 125	125	08-	CR8EB	384085	CR8EIX	490470
Satelis 125 Blacksat	125	12-	CR8EB	384085	CR8EIX	490470
Satelis 125 Compressor	125	06-	CR9EB	328861	CR9EIX	381550
Satelis 125 Compressor	125	12-	CR9EB	328861	CR9EIX	381550
Satelis 125 Executive	125	12-	CR8EB	384085	CR8EIX	490470
Satelis 125 GT Sport	125	06-	CR9EB	328861	CR9EIX	381550
Satelis 125 Roland Garros, Withesat	125	12-	CR8EB	384085	CR8EIX	490470
Satelis 250	250	06-	PMR8B	512439	-	-
Satelis 250	250	07-	CR9EB	328861	CR9EIX	381550
Satelis 250 RS	250	08-	PMR8B	512439	-	-
Satelis 400	400	07-	CR7EKB	450805	CR7EIX	490469
Satelis 400 Premium RS	400	11-	CR7EKB	450805	CR7EIX	490469
Satelis 400 RS	400	08-	CR7EKB	450805	CR7EIX	490469
Satelis 500, RS	500	07-	CR7EKB	450805	CR7EIX	490469
Satelis RS 125	125	09-	CR7E	213902	CR7EIX	490469
Sum Up 125	125	-07	CR7HSA	1861	CR7HIX	496398
Sum Up 125	125	08-09	CR9EB	328861	CR9EIX	381550
Sum Up 125	125	12-	CR8EB	384085	CR8EIX	490470
SV 125	125	10-	CR7HSA	1861	CR7HIX	496398
SV 125 Metropolis	125	-	BP6HS	490458	BPR6HIX	512414
SV 250	250	01-	DPR7EA-9	198282	DPR7EIX-9	512580
Tweet 125	125	-	BP6HS	490458	BPR6HIX	512414
Tweet 125 RS	125	10-	CR7HSA	1861	CR7HIX	496398
Tweet 150	150	10-	CR7HSA	1861	CR7HIX	496398
Vivacity 125	125	12-	CR7HSA	1861	CR7HIX	496398
Vivacity 125 Roland-Garros	125	10-	CR7HSA	1861	CR7HIX	496398
Vivacity 125 Sixties	125	12-	CR7HSA	1861	CR7HIX	496398
WTR 125	125	12-	CR7HSA	1861	CR7HIX	496398
X 125 LC	125	07-	CR9EB	328861	CR9EIX	381550
XPS 125 CT	125	06-08	CR7HSA	1861	CR7HIX	496398

MOTEUR

CYCLE

PNEUMATIQUE

ATELIER

ACCESSOIRES

ÉLECTRICITÉ

FILTRATION

FREINAGE

TRANSMISSION

Modèle	Cylindrée	Année	Bougie			Ref CGN iridium
				Ref CGN standard	Bougie iridium	
PIAGGIO						
Ape 125	125	-	BR7HS	172707	BR7HIX	497113
Ape 125	125	-	B7HS	1835	BR7HIX	497113
Ape 190	190	-	BR7HS	172707	BR7HIX	497113
Ape 190	190	-	B7HS	1835	BR7HIX	497113
Ape 220	220	-	B7HS	1835	BR7HIX	497113
Ape 220	220	-	BR7HS	172707	BR7HIX	497113
B 500	460	03-	CR7EKB	450805	CR7EIX	490469
Beverly 125, 125 GT, 125 Light	125	02-	CR8EB	384085	CR8EIX	490470
Beverly 200	200	02-	CR8EB	384085	CR8EIX	490470
Beverly 200	200	01-	CR8EB	384085	CR8EIX	490470
Beverly 250	250	03-	PMR8B	512439	-	-
Beverly 250 GTS Injection	250	06-	PMR8B	512439	-	-
Beverly 300 i.e.	300	11-	CR8EKB	496381	CR8EIX	490470
Beverly 350 Sport Touring	350	12-	CR8EKB	496381	CR8EIX	490470
Beverly 400	400	07-	CR7EKB	450805	CR7EIX	490469
Beverly 460	460	07-	CR7EKB	450805	CR7EIX	490469
Beverly 500	500	03-	CR7EKB	450805	CR7EIX	490469
Beverly Cruiser 500 TS	500	07-	CR7EKB	450805	CR7EIX	490469
Beverly Tourer 300 i.e.	300	10-	CR8EKB	496381	CR8EIX	490470
Carnaby 125	125	07-	CR8EB	384085	CR8EIX	490470
Carnaby 200	200	07-	CR8EB	384085	CR8EIX	490470
Carnaby 250	250	08-	PMR8B	512439	-	-
Carnaby 300	300	09-	CR8EKB	496381	CR8EIX	490470
Carnaby Cruiser 300 i.e.	300	10-	CR8EKB	496381	CR8EIX	490470
Cosa 125 FL	125	91-	B9ES	1844	BR9EIX	381511
Cosa 125 MA AE	125	88-	B9ES	1844	BR9EIX	381511
Cosa 150	150	-	BR9ES	1890	BR9EIX	381511
Cosa 200	200	-	B6ES	1841	-	-
Cosa 200	200	-	B8ES	1843	BR8EIX	381507
Cosa 200	200	93-97	BR8ES	1889	BR8EIX	381507
Cosa 200 FL	200	91-	BR8ES	1889	BR8EIX	381507
Cosa 200 FL EBC	125	-	B8ES	1843	BR8EIX	381507
Cosa 200 MA AE	200	-	BR8ES	1889	BR8EIX	381507
Cosa 200 MA AE	200	88-	BR8ES	1889	BR8EIX	381507
Cosa II MA AE	200	88-	BR8ES	1889	BR8EIX	381507
Cosa P200E	200	-	B6ES	1841	-	-
Cosa, Cosa II 125	125	90-95	BR9ES	1890	BR9EIX	381511
Cruiser 250	250	03-	PMR8B	512439	-	-
DN 200	200	-	BR7ES	455372	BR7EIX	497115
DS 200	200	-	BR7ES	455372	BR7EIX	497115
ET 3 125	125	-	BR7HS	172707	BR7HIX	497113



Modèle	Cylindrée	Année	NOK		NOK	
			Bougie	Ref CGN standard	Bougie iridium	Ref CGN iridium
ET 4 125	125	-	CR7EB	450804	CR7EIX	490469
EX 150 Hexagon	150	94-	B9ES	1844	BR9EIX	381511
Fly 125	125	05-	CR7EB	450804	CR7EIX	490469
Fly 125 3V	125	14-	CR8EB	384085	CR8EIX	490470
Fly 125 E3	125	-	CR7EKB	450805	CR7EIX	490469
Fly 150	150	08-	CR7EB	450804	CR7EIX	490469
GTS 125 Super	125	07-	CR8EB	384085	CR8EIX	490470
Hexagon 125	125	94-98	BR9ES	1890	BR9EIX	381511
Hexagon 125 GTX	125	00-02	CR9EB	328861	CR9EIX	381550
Hexagon 125 LX	125	94-	B9ES	1844	BR9EIX	381511
Hexagon 125 LX	125	98-00	BR9ES	1890	BR9EIX	381511
Hexagon 125 LX 2V Air	125	-	CR7EB	450804	CR7EIX	490469
Hexagon 125 LX 4V H2O	125	-	CR8EB	384085	CR8EIX	490470
Hexagon 150	150	94-	B9ES	1844	BR9EIX	381511
Hexagon 180 LXT	180	98-00	B9ES	1844	BR9EIX	381511
Hexagon 250 GT, X	250	98-	DPR6EA-9	490471	-	-
L 125 Granturismo	125	04-	CR9EB	328861	CR9EIX	381550
Leader 200 LXT	200	00-	CR9EB	328861	CR9EIX	381550
Liberty 125	125	98-00	CR7E	213902	CR7EIX	490469
Liberty 125	125	02-	CR7EB	450804	CR7EIX	490469
Liberty 125 E3	125	-	CR7EKB	450805	CR7EIX	490469
Liberty 125 Leader	125	01-	CR9EB	328861	CR9EIX	381550
Liberty 125 S E3	125	-	CR7EKB	450805	CR7EIX	490469
Liberty 150	150	02-	CR7EB	450804	CR7EIX	490469
Liberty 200	200	04-	CR7EB	450804	CR7EIX	490469
LX 125 Super	125	00-	CR9EB	328861	CR9EIX	381550
LX 2 125	125	97-	B9ES	1844	BR9EIX	381511
LX 4 125	125	98-00	CR7E	213902	CR7EIX	490469
Medley 125	125	16-	LMAR8EI-7	512545	-	-
Medley 150	150	16-	LMAR8EI-7	512545	-	-
MP3 125	125	06-	CR8EB	384085	CR8EIX	490470
MP3 125 Hybrid	125	09-	CR8EB	384085	CR8EIX	490470
MP3 125 i.e., RL	125	06-	CR8EB	384085	CR8EIX	490470
MP3 250	250	06-	PMR8B	512439	-	-
MP3 250 ie	250	-	CR9EB	328861	CR9EIX	381550
MP3 250 RL ie	250	-	PMR8B	512439	-	-
MP3 300 i.e. Hybrid	300	11-	CR8EKB	496381	CR8EIX	490470
MP3 300 LT i.e. Hybrid	300	11-	CR8EKB	496381	CR8EIX	490470
MP3 300 LT, LT i.e.	300	10-	CR8EKB	496381	CR8EIX	490470
MP3 300, 300 i.e.	300	10-	CR8EKB	496381	CR8EIX	490470
MP3 400	400	07-	CR7EKB	450805	CR7EIX	490469
MP3 400 LT i.e.	400	09-	CR7EKB	450805	CR7EIX	490469

MOTEUR

CYCLE

PNEUMATIQUE

ATELIER



ACCESSOIRES

ÉLECTRICITÉ



FILTRATION

FREINAGE

TRANSMISSION

Modèle	Cylindrée	Année	Bougie	 		
				Ref CGN standard	Bougie iridium	Ref CGN iridium
MP3 400 LT Sport ie	400	11-	CR7EKB	450805	CR7EIX	490469
MP3 400 RL ie	400	-	CR7EKB	450805	CR7EIX	490469
MP3 RST 250	250	06-	PMR8B	512439	-	-
MP3 RST 400 / Tourer 400 / X 400 EVO	400	07-	CR7EKB	450805	CR7EIX	490469
P 125 X	125	-	B6HS	1834	BR6HIX	497114
PE 200	200	-	BR7ES	455372	BR7EIX	497115
Piaggio 150	150	-	B9ES	1844	BR9EIX	381511
PK 125 XL	125	-	BR7HS	172707	BR7HIX	497113
PK 125 XL 2	125	-	B8ES	1843	BR8EIX	381507
PK 125, E, S	125	-	BR6HS	198206	BR6HIX	497114
PK Automatic	125	-	B7HS	1835	BR7HIX	497113
Primavera 125	125	-	B6HS	1834	BR6HIX	497114
Primavera ET3	125	-	B7HS	1835	BR7HIX	497113
PX 125 E Lusso	125	82-	B6HS	1834	BR6HIX	497114
PX 150 E Lusso	150	82-	B6HS	1834	BR6HIX	497114
PX 200 E Grand-Sport, E Lusso	200	84-	BR7ES	455372	BR7EIX	497115
Runner 125	125	02-	CR8EB	384085	CR8EIX	490470
Sfera 125	125	95-	CR9E	1863	CR9EIX	381550
Sfera 125 RL	125	-	CR9E	1863	CR9EIX	381550
Sfera 125 RST	125	95-	CR7E	213902	CR7EIX	490469
Skipper 125	125	00-	CR7EB	450804	CR7EIX	490469
Skipper 125 LX	125	93-	B9ES	1844	BR9EIX	381511
Skipper 150	150	93-	B9ES	1844	BR9EIX	381511
Skipper 150 ST	150	-00	BR9ES	1890	BR9EIX	381511
Skipper 150 ST	150	01-	CR7EB	450804	CR7EIX	490469
SKR 125	125	93-	B9ES	1844	BR9EIX	381511
SKR 150	150	98-	B9ES	1844	BR9EIX	381511
Sphera 125	125	95-99	CR9E	1863	CR9EIX	381550
Sphera 125 Air	125	00-	CR8EB	384085	CR8EIX	490470
ST 125 Skipper Leader	125	00-	CR9EB	328861	CR9EIX	381550
Super Hexagon 125 GTX	125	01-	CR8EB	384085	CR8EIX	490470
Super Hexagon 180 LXT	180	01-	CR8EB	384085	CR8EIX	490470
Super Hexagon 250 GTX	250	-	CR9E	1863	CR9EIX	381550
T5 125	125	85-	B8ES	1843	BR8EIX	381507
Tourer 125	125	02-	CR8EB	384085	CR8EIX	490470
Tourer 250	250	03-	PMR8B	512439	-	-
TPH 125	125	95-	B9ES	1844	BR9EIX	381511
Typhoon 125	125	95-03	B9ES	1844	BR9EIX	381511
Typhoon 125	125	10-	CR7EB	450804	CR7EIX	490469
Vespa 125 946	125	13-	CR8EB	384085	CR8EIX	490470
Vespa 125 CL	125	-	B6HS	1834	BR6HIX	497114
Vespa 125 ET4	125	96-	CR8EB	384085	CR8EIX	490470



Modèle	Cylindrée	Année	Bougie	 		
				Ref CGN standard	Bougie iridium	Ref CGN iridium
Vespa 125 ET4	125	99-	CR7EB	450804	CR7EIX	490469
Vespa 125 FL2	125	90-	B7HS	1835	BR7HIX	497113
Vespa 125 Gandturisticmo	125	-04	CR9EB	328861	CR9EIX	381550
Vespa 125 GT	125	03-	CR8EB	384085	CR8EIX	490470
Vespa 125 GTS	125	07-16	CR8EKB	496381	CR8EIX	490470
Vespa 125 GTS	125	16-	LMAR8EI-7	512545	-	-
Vespa 125 GTS Super i.e.	125	10-	CR8EKB	496381	CR8EIX	490470
Vespa 125 GTV	125	-	CR8EB	384085	CR8EIX	490470
Vespa 125 Leader ET 4	125	00-	CR9EB	328861	CR9EIX	381550
Vespa 125 LS	125	-	B6HS	1834	BR6HIX	497114
Vespa 125 LX	125	05-	CR7EB	450804	CR7EIX	490469
Vespa 125 LX	125	12-	CR8EB	384085	CR8EIX	490470
Vespa 125 LX 3V	125	12-	CR8EB	384085	CR8EIX	490470
Vespa 125 LX i.e.	125	09-	CR8EB	384085	CR8EIX	490470
Vespa 125 LXV	125	-	CR7EB	450804	CR7EIX	490469
Vespa 125 NK Primavera	125	-	B6HS	1834	BR6HIX	497114
Vespa 125 PK	125	85-	BR7HS	172707	BR7HIX	497113
Vespa 125 PK S Elestart	125	-	B6HS	1834	BR6HIX	497114
Vespa 125 PK XL Elestart	125	-	B7ES	1842	BR7EIX	497115
Vespa 125 PX E, E Iris	125	-	B6HS	1834	BR6HIX	497114
Vespa 125 PX Kat	125	-	BR7HS	172707	BR7HIX	497113
Vespa 125 PX MA AE	125	86-	B6HS	1834	BR6HIX	497114
Vespa 125 S	125	12-	CR8EB	384085	CR8EIX	490470
Vespa 125 S	125	08-	CR7EB	450804	CR7EIX	490469
Vespa 125 S 3V	125	12-	CR8EB	384085	CR8EIX	490470
Vespa 125 S i.e.	125	08-	CR7EB	450804	CR7EIX	490469
Vespa 125 Special ET3 Primavera	125	-	B7HS	1835	BR7HIX	497113
Vespa 125 Special ET4 Carburatore	125	-	CR8EB	384085	CR8EIX	490470
Vespa 125 T3, T3Li	125	-	B6HS	1834	BR6HIX	497114
Vespa 125 T5 Elestart, Sport, Sport Elestart	125	-	B9ES	1844	BR9EIX	381511
Vespa 125 T5, T5 Classic	125	85-99	B9ES	1844	BR9EIX	381511
Vespa 125 XL Elestart, Plurimat	125	-	B7HS	1835	BR7HIX	497113
Vespa 150	150	-	B6ES	1841	-	-
Vespa 150	150	-	B6HS	1834	BR6HIX	497114
Vespa 150 ET4	150	-01	CR7E	213902	CR7EIX	490469
Vespa 150 ET4	150	01-02	CR8EB	384085	CR8EIX	490470
Vespa 150 ET4	150	02-	CR7EB	450804	CR7EIX	490469
Vespa 150 GTS	150	16-	LMAR8EI-7	512545	-	-
Vespa 150 LX	150	08-11	CR7EB	450804	CR7EIX	490469
Vespa 150 LX i.e.	150	09-	CR7EB	450804	CR7EIX	490469
Vespa 150 LXV	150	-	CR7EB	450804	CR7EIX	490469
Vespa 150 PX Kat	150	-	BR6HS	198206	BR6HIX	497114

MOTEUR

CYCLE

PNEUMATIQUE

ATELIER



ACCESSOIRES

ÉLECTRICITÉ

FILTRATION



FREINAGE

TRANSMISSION



Modèle	Cylindrée	Année	Bougie	 		
				Ref CGN standard	Bougie iridium	Ref CGN iridium
Vespa 150 PX MA AE	150	96-	B6HS	1834	BR6HIX	497114
Vespa 150 PX MA AE	150	86-	B6HS	1834	BR6HIX	497114
Vespa 150 S	150	-	CR7EB	450804	CR7EIX	490469
Vespa 150 S i.e.	150	08-11	CR7EB	450804	CR7EIX	490469
Vespa 160, 160 GT	160	-	B6HS	1834	BR6HIX	497114
Vespa 175	175	-	B6HS	1834	BR6HIX	497114
Vespa 180 SS	180	-	B8ES	1843	BR8EIX	381507
Vespa 200 DN, DS, E	200	-	B5ES	512591	-	-
Vespa 200 Granturimo L	200	-	CR7EKB	450805	CR7EIX	490469
Vespa 200 PX E	200	-	B7ES	1842	BR7EIX	497115
Vespa 200 PX E Disc	200	98-	BR6ES	512536	-	-
Vespa 200 PX Iris, Iris Elestart	200	-	B7ES	1842	BR7EIX	497115
Vespa 200 PX MA AE	200	86-	B6ES	1841	-	-
Vespa 200 PX MA AE	200	96-	B6ES	1841	-	-
Vespa 200 Rally	200	-	BR7ES	455372	BR7EIX	497115
Vespa 200 TX	200	-	B7ES	1842	BR7EIX	497115
Vespa 200 TX Elestart	200	-	B7ES	1842	BR7EIX	497115
Vespa 250 GTS i.e.	250	06-	PMR8B	512439	-	-
Vespa 250 GTV i.e.	250	-	PMR8B	512439	-	-
Vespa 250 GTV Via Montenapoleone	250	11-	PMR8B	512439	-	-
Vespa 300 GTS Super	300	08-	CR8EKB	496381	CR8EIX	490470
Vespa 300 GTS Super Sport, Super Sport ie	300	11-	CR8EKB	496381	CR8EIX	490470
Vespa 300 GTV via Montenapoleone	300	10-	CR8EKB	496381	CR8EIX	490470
Vespa GT 200 Granturismo	200	03-07	CR7EB	450804	CR7EIX	490469
X 125 EVO	125	06-	CR8EB	384085	CR8EIX	490470
X10 125	125	12-	CR8EB	384085	CR8EIX	490470
X10 350	350	12-	CR8EKB	496381	CR8EIX	490470
X7 125	125	07-	CR8EB	384085	CR8EIX	490470
X7 125 EVO i.e.	125	07-	CR8EKB	496381	CR8EIX	490470
X7 250	250	07-	PMR8B	512439	-	-
X7 300 EVO i.e.	300	10-	CR8EKB	496381	CR8EIX	490470
X8 125	125	04-	CR8EB	384085	CR8EIX	490470
X8 125 Street	125	-	CR7EB	450804	CR7EIX	490469
X8 150 Street	150	-	CR7EB	450804	CR7EIX	490469
X8 200	200	05-	CR7EKB	450805	CR7EIX	490469
X8 250	250	06-08	CR8EB	384085	CR8EIX	490470
X8 250 i.e.	250	06-	PMR8B	512439	-	-
X8 400	400	06-	CR7EKB	450805	CR7EIX	490469
X9 125	125	00-02	CR9EB	328861	CR9EIX	381550
X9 125	125	02-	CR8EB	384085	CR8EIX	490470
X9 180 Amalfi	180	01-	CR8EB	384085	CR8EIX	490470
X9 250	250	00-03	DPR7EA-9	198282	DPR7EIX-9	512580



Modèle	Cylindrée	Année	Bougie	 		
				Ref CGN standard	Ref CGN iridium	
X9 250 EVO	250	07-	PMR8B	512439	-	
X9 250 Evolution	250	-	CR8EB	384085	CR8EIX 490470	
X9 500	500	03-	CR7EKB	450805	CR7EIX 490469	
X9 500 EVO	500	04-	CR7EKB	450805	CR7EIX 490469	
Xevo 125	125	07-	CR8EB	384085	CR8EIX 490470	
X-Evo 250	250	-	PMR8B	512439	-	
XR 125 Typhoon	125	-	B9ES	1844	BR9EIX 381511	
Zip 125	125	-	CR9EB	328861	CR9EIX 381550	
Zip 125	125	-	CR7EB	450804	CR7EIX 490469	
ZIP 125 New Edge Leader	125	00-	CR9EB	328861	CR9EIX 381550	
ZIP 125 New Edge Leader	125	01-	B9ES	1844	BR9EIX 381511	
PIONEER						
Nevada 125, Torro 125	125	08-	D8EA	1855	DR8EIX 493825	
RENAULT SPORT						
Kouranos, Fulltime, Groomy	125	01-	CR9EB	328861	CR9EIX 381550	
RFR						
Moteur Linhai	138	07-	C7HSA	465600	CR7HIX 496398	
RIEJU						
Endura 125	125	-	CR8E	1862	CR8EIX 490470	
Marathon 125	125	-	CR8E	1862	CR8EIX 490470	
Marathon 250	250	10-	CR8E	1862	CR8EIX 490470	
Marathon 450	450	10-	CR8E	1862	CR8EIX 490470	
MRX 125	125	03-	BR8ES	1889	BR8EIX 381507	
MRX 125	125	02-	CR7HSA	1861	CR7HIX 496398	
RS2 125 Martix	125	06-11	CR7HSA	1861	CR7HIX 496398	
RS2 125 NKD	125	06-11	CR7HSA	1861	CR7HIX 496398	
RS2 125 Pro	125	06-11	CR7HSA	1861	CR7HIX 496398	
RS3 125	125	11-	CR8E	1862	CR8EIX 490470	
RS3 125 NKD	125	11-	CR8E	1862	CR8EIX 490470	
SM 125	125	-	CR8E	1862	CR8EIX 490470	
SMX 125	125	03-	BR8ES	1889	BR8EIX 381507	
SMX 125	125	02-	CR7HSA	1861	CR7HIX 496398	
Tango 125 Pro	125	-	CR7HSA	1861	CR7HIX 496398	
Tango 250	250	-	D8EA	1855	DR8EIX 493825	
ROYAL ENFIELD						
Bullet - culot court	500	-	B8HS	1837	BR8HIX 381492	
Bullet - culot long	500	-	B8ES	1843	BR8EIX 381507	
Bullet & De Luxe - culot court	350	-	BR6HS	198206	BR6HIX 497114	
Bullet & De Luxe - culot long	350	-	BR6ES	512536	-	
Bullet Classic models	500	80-08	BR8ES	1889	BR8EIX 381507	
Bullet Electra X	500	04-	BR9ES	1890	BR9EIX 381511	
Scooter	125	-	B6HS	1834	BR6HIX 497114	

Modèle	Cylindrée	Année	Bougie	 		
				Ref CGN standard	Bougie iridium	Ref CGN iridium
RTX						
C 125, T 125	125	-	B7HS	1835	BR7HIX	497113
C 212, T 212	212	-	B8HS	1837	BR8HIX	381492
SACHS						
175 GS	175	-	B9ES	1844	BR9EIX	381511
250 GS	250	-	B9ES	1844	BR9EIX	381511
350 GS	350	-	-	-	BR9EIX	381511
4 rock	150	06-	C7HSA	465600	CR7HIX	496398
4 rock 250	250	06-	CR8HSA	213917	CR8HIX	504033
B 805	805	02-	DPR8EA-9	1857	DPR8EIX-9	496388
Eagle 125	125	09-	CR7HSA	1861	CR7HIX	496398
Helix	150	06-	C7HSA	465600	CR7HIX	496398
K 125 BW Military	125	74-	B8HS	1837	BR8HIX	381492
K 125 GS	125	-	B9ES	1844	BR9EIX	381511
K 125 MC	125	-	B9ES	1844	BR9EIX	381511
K 125 X	125	-	B8HS	1837	BR8HIX	381492
MadAss 125	125	06-10	CR7HSA	1861	CR7HIX	496398
Roadster 125 V2	125	98-	CR6HSA	213898	CR6HIX	512424
Roadster 650	650	99-	CR9E	1863	CR9EIX	381550
Roadster 800	800	01-	DPR8EA-9	1857	DPR8EIX-9	496388
RS 125	125	97-	BR8ES	1889	BR8EIX	381507
SR 125	125	-	BP6HS	490458	BPR6HIX	512414
SR 125 C	125	-	BP6HS	490458	BPR6HIX	512414
Superduke	125	97-	C7HSA	465600	CR7HIX	496398
SV 125	125	-	BP6HS	490458	BPR6HIX	512414
SV 125 C	125	-	BP6HS	490458	BPR6HIX	512414
W 2000	294	-	BR7ES	455372	BR7EIX	497115
X-Road 125	125	-	CR8E	1862	CR8EIX	490470
XTC 125	125	02-07	CR8E	1862	CR8EIX	490470
XTC 125 V2	125	98-01	BR9ES	1890	BR9EIX	381511
XTC-N 125	125	98-01	BR8ES	1889	BR8EIX	381507
XTC-N 125 Racing 'V2	125	98-01	BR8ES	1889	BR8EIX	381507
ZX 125	125	97-	BR8ES	1889	BR8EIX	381507
ZX 125 - 11PS	125	97-	BR8ES	1889	BR8EIX	381507
ZX 125 - 15PS	125	97-	BR9ES	1890	BR9EIX	381511
ZZ 125	125	01-	BR9ES	1890	BR9EIX	381511
ZZ 125	125	01-	BR8ES	1889	BR8EIX	381507
SAN YANG						
Duke 125	125	-	C7HSA	465600	CR7HIX	496398
Euro MX 125	125	-	CR7HSA	1861	CR7HIX	496398
GTS 125	125	-	CR8E	1862	CR8EIX	490470
GTS 250	250	-	CR8E	1862	CR8EIX	490470





Modèle	Cylindrée	Année	Bougie	 		
				Ref CGN standard	Bougie iridium	Ref CGN iridium
HD 125 Evo	125	-	CR8E	1862	CR8EIX	490470
HD 200 i	171	-	CR8E	1862	CR8EIX	490470
Husky 125	125	95-	DR8EA	198225	DR8EIX	493825
Joyride 125	125	-	CR7HSA	1861	CR7HIX	496398
RS 4V 125	125	-	CR7HSA	1861	CR7HIX	496398
Super Duke 125	125	-	C7HSA	465600	CR7HIX	496398
SCORPA						
250, E	250	-	-	-	BKR6EIX	512421
280R	272	11-	BP5ES	490456	BPR5EIX	511478
294, 295	300	11-	BP5ES	490456	BPR5EIX	511478
Easy Trial	250	94-	BP5ES	490456	BPR5EIX	511478
Easy Trial	280	94-	BP5ES	490456	BPR5EIX	511478
F	125	04-06	CR7HSA	1861	CR7HIX	496398
F	125	12-	CR6HSA	213898	CR6HIX	512424
F	175	03-09	CR7HSA	1861	CR7HIX	496398
F Long Rider	250	07-	CR8E	1862	CR8EIX	490470
FR	125	03-09	CR7HSA	1861	CR7HIX	496398
FR	175	03-09	CR7HSA	1861	CR7HIX	496398
FR	250	07-	CR8E	1862	CR8EIX	490470
Long Ride	250	00-	-	-	BPR6EIX	512415
R	125	11-	BP5ES	490456	BPR5EIX	511478
R	280	11-	BP5ES	490456	BPR5EIX	511478
Ride F	250	08-	CR8E	1862	CR8EIX	490470
SY 250 Racing	250	01-09	-	-	BKR5EIX	512437
SHERCO						
2.0	200	99-	BP5ES	490456	BPR5EIX	511478
2.5	249	01-	BP5ES	490456	BPR5EIX	511478
2.5i-F	250	08-11	CR8EK	461666	CR8EIX	490470
2.9	272	01-	BP5ES	490456	BPR5EIX	511478
290 2,9 ST	290	14-	BP5ES	490456	BPR5EIX	511478
290 2,9 ST	290	99-	BP5ES	490456	BPR5EIX	511478
3.0i-F	290	10-11	CR8EK	461666	CR8EIX	490470
4.5	450	05-	CR8EK	461666	CR8EIX	490470
4.5 Enduro	448	05-	CR8EK	461666	CR8EIX	490470
4.5 Supermotard	448	05-	CR8EK	461666	CR8EIX	490470
4.5i-F 4T	450	04-	CR8EK	461666	CR8EIX	490470
450i	448	08-	CR8EK	461666	CR8EIX	490470
5.1 Enduro	510	08-	CR8EK	461666	CR8EIX	490470
5.1 Supermotard	510	08-	CR8EK	461666	CR8EIX	490470
5.li	510	05-	CR8EK	461666	CR8EIX	490470
Academy	125	09-	BP5ES	490456	BPR5EIX	511478
Access 2.5	250	10-	BP5ES	490456	BPR5EIX	511478

Modèle	Cylindrée	Année	NGK		NGK	
			Bougie	Ref CGN standard	Bougie iridium	Ref CGN iridium
Access 2.9	290	10-	BP5ES	490456	BPR5EIX	511478
City Corp 125	125	03-07	CR7HSA	1861	CR7HIX	496398
City Corp 125 Enduro	125	08-	CR6HSA	213898	CR6HIX	512424
City Corp 125 Supermotard	125	08-	CR6HSA	213898	CR6HIX	512424
Scottish Six Days Winner	250	00-	BP5ES	490456	BPR5EIX	511478
SE 250	250	14-	BR8ES	1889	BR8EIX	381507
SE 250i	250	12-	CR8EK	461666	CR8EIX	490470
SE 300	300	14-	BR8ES	1889	BR8EIX	381507
SE 300i	290	12-	CR8EK	461666	CR8EIX	490470
SEF 250	250	14-	CR8EK	461666	CR8EIX	490470
SEF 300	300	14-	CR8EK	461666	CR8EIX	490470
SEF-R 250	250	14-	CR8EK	461666	CR8EIX	490470
SEF-R 300	300	14-	CR8EK	461666	CR8EIX	490470
SE-R 250	250	14-	BR8ES	1889	BR8EIX	381507
SE-R 300	300	14-	BR8ES	1889	BR8EIX	381507
ST 1.25	125	01-	BP5ES	490456	BPR5EIX	511478
ST 250	250	14-	BP5ES	490456	BPR5EIX	511478
ST 250 2.5	250	99-	BP5ES	490456	BPR5EIX	511478
Trial 125 1,25	125	00-	BP5ES	490456	BPR5EIX	511478
Trial 125 1,25	125	08-	BP5ES	490456	BPR5EIX	511478
Trial 2,5	250	00-	BP5ES	490456	BPR5EIX	511478
Trial 2,9	250	00-	BP5ES	490456	BPR5EIX	511478
Trial 305 ST	305	14-	BP5ES	490456	BPR5EIX	511478
Trial 320 3.2	317	06-	BCPR6E	512547	BCPR6EIX	512435
X-Ride 125	125	14-	BPR5ES	198191	BPR5EIX	511478
X-Ride 290	272	12-	BPR5ES	198191	BPR5EIX	511478
X-Ride 290	290	14-	BP5ES	490456	BPR5EIX	511478
SKYTEAM						
Dax	125	08-	CR7HSA	1861	CR7HIX	496398
Wacky ST125, Y	125	-	C7HSA	465600	CR7HIX	496398
SMC						
CHP 125 Chopper	125	-	DR8EA	198225	DR8EIX	493825
SPIGAOU						
Dax (moteur Loncin)	125	-	CR7HSA	1861	CR7HIX	496398
SUNDIRO						
Phönix XDZ 125 T, TA	125	96-	CR7HSA	1861	CR7HIX	496398
Phönix XDZ TN	125	96-	DR8EA	198225	DR8EIX	493825
SUZUKI						
350 Goose	350	93-	CR9EK	213936	CR9EIX	381550
Address 125	125	07-	CR8E	1862	CR8EIX	490470
AN 125	125	95-96	CR8E	1862	CR8EIX	490470
AN 125	125	97-99	CR7E	213902	CR7EIX	490469





Modèle	Cylindrée	Année	NOK		NOK	
			Bougie	Ref CGN standard	Bougie iridium	Ref CGN iridium
AN 125- S	125	95	CR8E	1862	CR8EIX	490470
AN 125- T/ V/ W/ X/ Y/	125	96	CR7E	213902	CR7EIX	490469
AN 125- U	125	97-99	CR7E	213902	CR7EIX	490469
AN 125- V	125	97	CR9E	1863	CR9EIX	381550
AN 125- W	125	98-98	CR9E	1863	CR9EIX	381550
AN 125- X	125	99	CR9E	1863	CR9EIX	381550
AN 150 T	150	96-	CR7E	213902	CR7EIX	490469
AN 200 Burgman	200	-	CR8EK	461666	CR8EIX	490470
AN 250 Burgman	250	98-99	CR8EK	461666	CR8EIX	490470
AN 250 Burgman	250	04-	CR7EK	512551	CR7EIX	490469
AN 400 A Burgman ABS	400	09-17	CR7E	213902	CR7EIX	490469
AN 400 Burgman	400	99-16	CR7E	213902	CR7EIX	490469
AN 400 Burgman	400	18-	CR7EIA-9	512554	-	-
AN 400 S Burgman	400	05-06	CR7E	213902	CR7EIX	490469
AN 400 Z Burgman	400	07-08	CR7E	213902	CR7EIX	490469
AN 400 ZA Burgman ABS	400	09-16	CR7E	213902	CR7EIX	490469
AN 650 A Burgman Executive	650	04-12	CR8E	1862	CR8EIX	490470
AN 650 Burgman	650	02-11	CR8E	1862	CR8EIX	490470
AN 650 Burgman	650	13-16	CR8E	1862	CR8EIX	490470
AN 650 L Burgman Executive	650	03-03	CR8E	1862	CR8EIX	490470
AN 650 Z Burgman Executive	650	13-17	CR8E	1862	CR8EIX	490470
AN 650 Z Burgman Executive	650	17-	CR8E	1862	CR8EIX	490470
C 1500 T Intruder	1500	13-	CPR6EA-9	512474	CPR6EAIX-9S	512427
C 1500 T Intruder	1500	-	CPR6EA-9	512474	CPR6EAIX-9S	512427
C1800 R Intruder	1800	08-13	CR8EK	461666	CR8EIX	490470
CS 125	125	-	DR8ES-L	1859	DR8EIX	493825
DF 125 E	125	99-	DR8EA	198225	DR8EIX	493825
DF 125 EX	125	99-	DR8EA	198225	DR8EIX	493825
DL 1000 V-Strom	1000	02-12	CR8EK	461666	CR8EIX	490470
DL 1000 V-Strom	1000	13	CR8EIA-9	512615	-	-
DL 1000 V-Strom	1000	14-	LMAR8BI-9	512557	-	-
DL 1000 V-Strom XT	1000	17-	LMAR8BI-9	512557	-	-
DL 250 V-Strom	250	17-	CPR7EA-9	496389	CPR7EAIX-9	512587
DL 650 V-Strom	650	04-11	CR8E	1862	CR8EIX	490470
DL 650 V-Strom A	650	07-11	CR8E	1862	CR8EIX	490470
DL 650 V-Strom A	650	12-16	CR8EIA-9	512615	-	-
DL 650 V-Strom A	650	17-	MR8E-9	512550	-	-
DL 650 V-Strom A U3	650	07-11	CR8E	1862	CR8EIX	490470
DL 650 V-Strom A U3, AUE	650	04-10	CR8E	1862	CR8EIX	490470
DL 650 V-Strom AUE	650	07-11	CR8E	1862	CR8EIX	490470
DL 650 V-Strom AUE	650	17-	MR8E-9	512550	-	-



Modèle	Cylindrée	Année	Bougie	 		
				Ref CGN standard	Bougie iridium	Ref CGN iridium
DL 650 V-Strom XT	650	17-	MR8E-9	512550	-	-
DL 650 V-Strom XT A, AUE	650	15-16	CR8EIA-9	512615	-	-
DL 650 V-Strom XT AUE	650	17-	MR8E-9	512550	-	-
DR 125 SE	125	95-00	DR8EA	198225	DR8EIX	493825
DR 125 SEU	125	95-00	DR8EA	198225	DR8EIX	493825
DR 125 SJ	125	-	DR8ES-L	1859	DR8EIX	493825
DR 125 SM	125	08-13	CR8E	1862	CR8EIX	490470
DR 200 S	200	-	DR8ES-L	1859	DR8EIX	493825
DR 200 SZ	200	95-	DR8EA	198225	DR8EIX	493825
DR 250	250	91-	DPR9EA-9	1860	DPR9EIX-9	512585
DR 250 S	250	90-	DPR9EA-9	1860	DPR9EIX-9	512585
DR 250 SZ	250	95-	DPR9EA-9	1860	DPR9EIX-9	512585
DR 250 SZ-H	250	-	DR8ES-L	1859	DR8EIX	493825
DR 350	350	94-95	CR9EK	213936	CR9EIX	381550
DR 350 SE	350	94-99	CR9EK	213936	CR9EIX	381550
DR 500 S- X	500	81-	DR8ES-L	1859	DR8EIX	493825
DR 600	600	-	DPR9EA-9	1860	DPR9EIX-9	512585
DR 650 R, RE, REU	650	90-96	DPR9EA-9	1860	DPR9EIX-9	512585
DR 650 RS, RSE, RSEU	650	90-96	DPR9EA-9	1860	DPR9EIX-9	512585
DR 650 RSU, RU	650	90-96	DPR9EA-9	1860	DPR9EIX-9	512585
DR 650 SE	650	96-00	CR10E	512457	CR10EIX	498279
DR 750 S	750	-	DPR9EA-9	1860	DPR9EIX-9	512585
DR 800 S, SU	800	91-99	DPR9EA-9	1860	DPR9EIX-9	512585
DR-Z 125 L	125	07-	DR8EA	198225	DR8EIX	493825
DR-Z 400	400	00-04	CR8E	1862	CR8EIX	490470
DR-Z 400 E	400	05-07	CR8E	1862	CR8EIX	490470
DR-Z 400 S	400	00-09	CR8E	1862	CR8EIX	490470
DR-Z 400 SM	400	05-09	CR8E	1862	CR8EIX	490470
DR-Z 400 SMU	400	05-07	CR8E	1862	CR8EIX	490470
EN 125 2A	125	03-09	CR8E	1862	CR8EIX	490470
FL 125 DW	125	07-09	CR6HSA	213898	CR6HIX	512424
GN 125	125	91-99	DR8EA	198225	DR8EIX	493825
GN 125 U	125	91-99	DR8EA	198225	DR8EIX	493825
GN 250	250	98-99	DR8EA	198225	DR8EIX	493825
GN 250	250	85-97	DR8ES-L	1859	DR8EIX	493825
GN 250 EZ-J	250	-	DR8ES-L	1859	DR8EIX	493825
GP 125	125	-	B8HS	1837	BR8HIX	381492
GS 1100 E	1100	-	DR8ES-L	1859	DR8EIX	493825
GS 1100 G, GG	1100	-	B8ES	1843	BR8EIX	381507
GS 1100 GT	1100	-	B8ES	1843	BR8EIX	381507
GS 1150 EF, ES	1150	-	D9EA	214067	DR9EIX	512583
GS 125 S	125	-98	DR8ES-L	1859	DR8EIX	493825



Modèle	Cylindrée	Année	NOK		NOK	
			Bougie	Ref CGN standard	Bougie iridium	Ref CGN iridium
GS 125 S	125	99-	DR8EA	198225	DR8EIX	493825
GS 425 E	425	79-	B8ES	1843	BR8EIX	381507
GS 425 N	425	79-	B8ES	1843	BR8EIX	381507
GS 450 SF	450	80-	BR8ES	1889	BR8EIX	381507
GS 500	500	01-06	DPR8EA-9	1857	DPR8EIX-9	496388
GS 500 E, EU	500	89-00	DPR8EA-9	1857	DPR8EIX-9	496388
GS 500 F	500	01-05	DPR8EA-9	1857	DPR8EIX-9	496388
GS 500 FH, FM	500	07-08	DPR8EA-9	1857	DPR8EIX-9	496388
GS 500 FU	500	04-06	DPR8EA-9	1857	DPR8EIX-9	496388
GS 500 H, HU	500	07-08	DPR8EA-9	1857	DPR8EIX-9	496388
GS 500 U	500	01-06	DPR8EA-9	1857	DPR8EIX-9	496388
GS 750 D	750	-	B8ES	1843	BR8EIX	381507
GS 750 E	750	-	B8ES	1843	BR8EIX	381507
GS 750 L	750	-	B8ES	1843	BR8EIX	381507
GS 850 G, GT E-G	850	-	B8ES	1843	BR8EIX	381507
GSF 1200 A Bandit	1200	06-06	JR9B	1893	DR9EIX	512583
GSF 1200 Bandit, S Bandit	1200	96-06	JR9B	1893	DR9EIX	512583
GSF 1200 SA Bandit	1200	96-00	JR9B	1893	DR9EIX	512583
GSF 1200 SA, SZ Bandit	1200	05-06	JR9B	1893	DR9EIX	512583
GSF 1250 Bandit	1250	07-	CR7E	213902	CR7EIX	490469
GSF 400 BANDIT	400	93-95	CR9EK	213936	CR9EIX	381550
GSF 600 Bandit	600	00-04	CR9EK	213936	CR9EIX	381550
GSF 600 J	600	88-	DR8ES	1858	DR8EIX	493825
GSF 600 S Bandit	600	95-99	CR9EK	213936	CR9EIX	381550
GSF 600 SU Bandit	600	96-04	CR9EK	213936	CR9EIX	381550
GSF 600 U Bandit	600	96-99	CR9EK	213936	CR9EIX	381550
GSF 600 U Bandit	600	00-04	CR9EK	213936	CR9EIX	381550
GSF 600 Y Bandit	600	00-	CR9EK	213936	CR9EIX	381550
GSF 650 A Bandit	650	05-06	CR8EK	461666	CR8EIX	490470
GSF 650 A Bandit	650	07-13	CR9E	1863	CR9EIX	381550
GSF 650 Bandit	650	05-06	CR8EK	461666	CR8EIX	490470
GSF 650 Bandit	650	07-13	CR9E	1863	CR9EIX	381550
GSF 650 Bandit N, S	650	07-07	CR9E	1863	CR9EIX	381550
GSF 650 S Bandit	650	05-06	CR8EK	461666	CR8EIX	490470
GSF 650 S Bandit	650	07-14	CR8E	1862	CR8EIX	490470
GSF 650 SA Bandit	650	05-06	CR8EK	461666	CR8EIX	490470
GSF 650 SA Bandit	650	07-14	CR8E	1862	CR8EIX	490470
GSF 650 SU Bandit	650	07-14	CR8E	1862	CR8EIX	490470
GSF 650 SU Bandit	650	05-06	CR8EK	461666	CR8EIX	490470
GSF 650 SUA Bandit	650	05-06	CR8EK	461666	CR8EIX	490470
GSF 650 SUA Bandit	650	07-14	CR8E	1862	CR8EIX	490470
GSF 650 U Bandit	650	05-06	CR8EK	461666	CR8EIX	490470

Modèle	Cylindrée	Année	Bougie	 		
				Ref CGN standard	Bougie iridium	Ref CGN iridium
GSF 650 U Bandit	650	07-14	CR8E	1862	CR8EIX	490470
GSF 650 UA Bandit	650	05-06	CR8EK	461666	CR8EIX	490470
GSF 650 UA Bandit	650	07-14	CR8E	1862	CR8EIX	490470
GSR 600	600	06-10	CR9E	1863	CR9EIX	381550
GSR 600 A	600	07-11	CR9E	1863	CR9EIX	381550
GSR 600 U	600	06-10	CR9E	1863	CR9EIX	381550
GSR 600 UA	600	07-11	CR9E	1863	CR9EIX	381550
GSR 750	750	11-	CR9EIA-9	496379	-	-
GSX 1000 E	1000	86-	DPR9EA-9	1860	DPR9EIX-9	512585
GSX 1100 F	1100	88-96	JR9B	1893	DR9EIX	512583
GSX 1100 G	1100	91-96	JR9B	1893	DR9EIX	512583
GSX 1150 E	1150	86-	DPR9EA-9	1860	DPR9EIX-9	512585
GSX 1150 EF, ES	1150	-	DR8ES	1858	DR8EIX	493825
GSX 1200 Inazuma	1200	99-00	JR8B	512558	DR8EIX	493825
GSX 1250 FA	1250	10-	CR7E	213902	CR7EIX	490469
GSX 1300 BK B-King	1340	08-10	CR9EIA-9	496379	-	-
GSX 1300 BKA B-King	1340	08-12	CR9EIA-9	496379	-	-
GSX 1300 BKA B-King	1340	08-	CR9EIA-9	496379	-	-
GSX 1300 R Hayabusa	1300	99-07	CR9E	1863	CR9EIX	381550
GSX 1300 R Hayabusa	1300	08-	CR9EIA-9	496379	-	-
GSX 1400	1400	01-07	CR8EK	461666	CR8EIX	490470
GSX 250 R	250	87-88	LR8A	512552	-	-
GSX 400 EF, SE	400	-	DR8ES-L	1859	DR8EIX	493825
GSX 400 FW	400	-	CR8HS	512555	CR8HIX	504033
GSX 600 F	600	88-95	DR8ES	1858	DR8EIX	493825
GSX 600 F	600	96-01	CR9EK	213936	CR9EIX	381550
GSX 600 FU	600	88-95	DR8ES	1858	DR8EIX	493825
GSX 600 FU	600	96-01	CR9EK	213936	CR9EIX	381550
GSX 600 FU2	600	88-95	DR8ES	1858	DR8EIX	493825
GSX 600 FU2	600	96-01	CR9EK	213936	CR9EIX	381550
GSX 650 A	650	08-	CR8E	1862	CR8EIX	490470
GSX 650 F	650	08-	CR8E	1862	CR8EIX	490470
GSX 650 SA	650	08-	CR8E	1862	CR8EIX	490470
GSX 750	750	98-03	CR9EK	213936	CR9EIX	381550
GSX 750 F	750	89-97	JR9C	496390	DR9EIX	512583
GSX 750 F	750	98-06	CR9EK	213936	CR9EIX	381550
GSX 750 T	750	-	DR8ES-L	1859	DR8EIX	493825
GSX-R 1000	1000	-99	JR9B	1893	DR9EIX	512583
GSX-R 1000	1000	01-02	CR9E	1863	CR9EIX	381550
GSX-R 1000	1000	03-05	CR9E	1863	CR9EIX	381550
GSX-R 1000	1000	05-06	CR9E	1863	CR9EIX	381550
GSX-R 1000	1000	07-	CR9EIA-9	496379	-	-



Modèle	Cylindrée	Année	Bougie	 		
				Ref CGN standard	Bougie iridium	Ref CGN iridium
GSX-R 1000 R	1000	17-	CR9EIA-9	496379	-	-
GSX-R 1100 W	1100	93-97	CR9E	1863	CR9EIX	381550
GSX-R 125	125	17-	MR8E-9	512550	-	-
GSX-R 600	600	08-	CR9EIA-9	496379	-	-
GSX-R 600 U1, U2	600	08-	CR9EIA-9	496379	-	-
GSX-R 600 U2, U3	600	96-07	CR9E	1863	CR9EIX	381550
GSX-R 600 U3, UE, UF	600	08-	CR9EIA-9	496379	-	-
GSX-R 600, U1	600	96-07	CR9E	1863	CR9EIX	381550
GSX-R 750	750	96-07	CR9E	1863	CR9EIX	381550
GSX-R 750	750	08-	CR9EIA-9	496379	-	-
GSX-R 750 U2	750	04-07	CR9E	1863	CR9EIX	381550
GSX-R 750 U2, UF	750	08-16	CR9EIA-9	496379	-	-
GSX-R 750 W	750	94-95	CR9E	1863	CR9EIX	381550
GSX-R 750 X, XU2	750	05	CR9E	1863	CR9EIX	381550
GSX-R400	400	86-88	LR8A	512552	-	-
GSX-R400	400	93-	CR9EK	213936	CR9EIX	381550
GSX-R400 H	400	-	C8HSA	512537	CR8HIX	504033
GSX-S 1000	1000	15-	CR9EIA-9	496379	-	-
GSX-S 1000 F	1000	15-	CR9EIA-9	496379	-	-
GSX-S 125	125	17-	MR8E-9	512550	-	-
GSX-S 750 A, AZ	750	16-	CR9EIA-9	496379	-	-
GT 250 A	250	-	B8HS	1837	BR8HIX	381492
GT 250 A	250	-	B9ES	1844	BR9EIX	381511
GT 250 AB	250	-	B9ES	1844	BR9EIX	381511
GT 250 B	250	-	B8HS	1837	BR8HIX	381492
GT 250 B	250	-	B9ES	1844	BR9EIX	381511
GT 250 C	250	-	B8HS	1837	BR8HIX	381492
GT 250 C	250	-	B9ES	1844	BR9EIX	381511
GT 750	750	-	B7ES	1842	BR7EIX	497115
GT 750 L	750	74-	B9ES	1844	BR9EIX	381511
GV 1200 GL	1200	86-	DR8ES-L	1859	DR8EIX	493825
GW 250 Inazuma	250	13-	CR7E	213902	CR7EIX	490469
GZ 125 Marauder	125	98-03	DR8EA	198225	DR8EIX	493825
GZ 125 Marauder	125	04-07	CR8E	1862	CR8EIX	490470
GZ 125 Marauder	125	08-13	CR7E	213902	CR7EIX	490469
GZ 125 U Marauder	125	98-04	DR8EA	198225	DR8EIX	493825
GZ 250 Marauder	250	99-08	DR8EA	198225	DR8EIX	493825
LS 650 Savage	650	86-00	DPR8EA-9	1857	DPR8EIX-9	496388
M 1500 Intruder	1500	09-	CR6E	512559	-	-
M 800 Intruder, Z Intruder	800	09-	DR7EA	496396	DR7EIX	512413
M1800 R Intruder / VZR 1800 Intruder	1800	06-	CR8EK	461666	CR8EIX	490470
PE 175	175	79-	-	-	BR10EIX	381617

MOTEUR

CYCLE

PNEUMATIQUE

ATELIER

ACCESSOIRES

ÉLECTRICITÉ



FILTRATION



FREINAGE

TRANSMISSION

Modèle	Cylindrée	Année	Bougie			Ref CGN iridium
				Ref CGN standard	Bougie iridium	
RC 125	125	-	B7HS	1835	BR7HIX	497113
RF 600 R, RU	600	93-96	CR9E	1863	CR9EIX	381550
RF 900 R	900	94-97	CR9E	1863	CR9EIX	381550
RG 125 F Gamma	125	92-96	BR9ECM	214181	BR9ECMIX	496382
RG 125 FU Gamma	125	92-96	BR9ECM	214181	BR9ECMIX	496382
RG 125 P	125	-	BR9ECM	214181	BR9ECMIX	496382
RG 125 R	125	-	BR9ECM	214181	BR9ECMIX	496382
RG 125 U Wolf	125	-	BR9ECM	214181	BR9ECMIX	496382
RG 250 C - C / E / H	250	-	BR9ES	1890	BR9EIX	381511
RG 250 FC - C / E / H	250	-	BR9ES	1890	BR9EIX	381511
RG 250 G-C - C / E / H	250	-	BR9ES	1890	BR9EIX	381511
RG 250 W- C / E / H	250	-	BR9ES	1890	BR9EIX	381511
RM 125	125	93-95	-	-	BR9EIX	381511
RM 125	125	96-12	R6918B-8	512528	-	-
RM 250	250	93-00	-	-	BR8EIX	381507
RM 250	250	01-12	BR8EG	214162	-	-
RM 495	495	-	-	-	BR8EIX	381507
RMX 250	250	91-98	-	-	BR8EIX	381507
RMX 450 Z	450	10-	CR8EIB-10	512553	-	-
RM-Z 250	250	04-06	CR8EB	384085	CR8EIX	490470
RM-Z 250	250	07-	CR8EIA-10	512613	-	-
RM-Z 250- L4>>>	250	14-	CR8EIB-10	512553	-	-
RM-Z 450	450	05-06	CR8EIB-10	512553	-	-
RM-Z 450	450	07-	DIMR8C10	512556	-	-
RV 125 Van Van - 8,5kW	125	07-	CR8E	1862	CR8EIX	490470
RV 125 Van Van - 8,7kW	125	03-07	CR8E	1862	CR8EIX	490470
RV 200 Van Van	200	16-	DR8EA	198225	DR8EIX	493825
Scooter 125	125	08-	CR6HSA	213898	CR6HIX	512424
SFV 650 Gladius	650	09-15	CR8EIA-9	512615	-	-
SV 1000 N, S	1000	03-	CR8EK	461666	CR8EIX	490470
SV 650	650	99-16	CR8E	1862	CR8EIX	490470
SV 650	650	07-16	CR8E	1862	CR8EIX	490470
SV 650	650	16-	MR8E-9	512550	-	-
T 350 2T	350	71-	B8HCS	512614	BR8HIX	381492
TL 1000 R	1000	98-	CR10EK	213947	CR10EIX	498279
TL 1000 S	1000	97-00	CR8EK	461666	CR8EIX	490470
TS 185 ER	185	93-	BPR7ES	1848	BPR7EIX	512582
TS 200	200	-	BR9ES	1890	BR9EIX	381511
TS 400 - A / B	400	72-	B9ES	1844	BR9EIX	381511
TU 125 XT	125	99-	DR8EA	198225	DR8EIX	493825
TU 250 X Volty	250	97-97	DR8ES-L	1859	DR8EIX	493825
TU 250 X Volty	250	98-01	DR8EA	198225	DR8EIX	493825





Modèle	Cylindrée	Année	Bougie	 		
				Ref CGN standard	Bougie iridium	Ref CGN iridium
UC 125 U Epicuro	125	99-03	CR8E	1862	CR8EIX	490470
UE 125 CT	125	01-03	CR7E	213902	CR7EIX	490469
UH 125 Burgman- K2>L4	125	02-	CR8E	1862	CR8EIX	490470
UH 150 Burgman	150	04-06	CR8E	1862	CR8EIX	490470
UH 200 Burgman- K7	200	07-10	CR8EK	461666	CR8EIX	490470
UX 125 Sixteen	125	07-	CR8E	1862	CR8EIX	490470
UX 125 Sixteen	125	08-14	CR8E	1862	CR8EIX	490470
UX 150 Sixteen	150	08-10	CR8E	1862	CR8EIX	490470
VL 125 LC Intruder	125	00-08	CR8E	1862	CR8EIX	490470
VL 125 LC U Intruder	125	00-08	CR8E	1862	CR8EIX	490470
VL 1500 Intruder C	1500	05-09	DPR7EA-9	198282	DPR7EIX-9	512580
VL 1500 Intruder LC	1500	98-04	DPR7EA-9	198282	DPR7EIX-9	512580
VL 250 Intruder	250	00-07	CR8E	1862	CR8EIX	490470
VL 800 C800 Intruder, UE	800	06-08	DPR7EA-9	198282	DPR7EIX-9	512580
VL 800 C800 Intruder, UE	800	09-	DR7EA	496396	DR7EIX	512413
VL 800 C800B Intruder, UE	800	14-16	DR7EA	496396	DR7EIX	512413
VL 800 C800C CUE Intruder	800	09-16	DR7EA	496396	DR7EIX	512413
VL 800 C800C Intruder	800	07-08	DPR7EA-9	198282	DPR7EIX-9	512580
VL 800 C800C Intruder	800	09-16	DR7EA	496396	DR7EIX	512413
VL 800 Volusia, Z Volusia	800	01-05	DPR7EA-9	198282	DPR7EIX-9	512580
VLR1800 Intruder	1800	08-11	CR8EK	461666	CR8EIX	490470
VS1400 Intruder	1400	87-03	DPR8EA-9	1857	DPR8EIX-9	496388
VS 400	400	95-	DPR8EA-9	1857	DPR8EIX-9	496388
VS 600 GL Intruder, GLU Intruder	600	95-97	DPR8EA-9	1857	DPR8EIX-9	496388
VS 800 Intruder	800	92-00	DPR8EA-9	1857	DPR8EIX-9	496388
VX 800, U	800	90-97	DPR8EA-9	1857	DPR8EIX-9	496388
VZ 1500 Intruder MI500	1500	09-11	CR6E	512559	-	-
VZ 1600 Marauder 1600	1600	04-05	DPR6EA-9	490471	-	-
VZ 800 M 800 U, UE Intruder	800	09-10	DR7EA	496396	DR7EIX	512413
VZ 800 M800 Intruder	800	09-16	DR7EA	496396	DR7EIX	512413
VZ 800 M800 Intruder, U	800	05-08	DPR7EA-9	198282	DPR7EIX-9	512580
VZ 800 M800 Z, ZU Intruder	800	07-08	DPR7EA-9	198282	DPR7EIX-9	512580
VZ 800 M800 Z, ZU Intruder	800	09-09	DR7EA	496396	DR7EIX	512413
VZ 800 Marauder	800	97-03	DPR8EA-9	1857	DPR8EIX-9	496388
XF 650 Freewind	650	97-02	CR10E	512457	CR10EIX	498279
SWM						
Gran Milano 440	440	16-	DPR8Z	512603	-	-
Gran Turismo 440	440	16-	DPR8Z	512603	-	-
RS 125 R	125	16-	CR8E	1862	CR8EIX	490470
RS 300 R	300	16-	CR8EB	384085	CR8EIX	490470
RS 500 R	500	16-	CR8EB	384085	CR8EIX	490470
Siver Vase 440	440	16-	DPR8Z	512603	-	-

Modèle	Cylindrée	Année	Bougie	 		
				Ref CGN standard	Bougie iridium	Ref CGN iridium
SM 125 R	125	16-	CR8E	1862	CR8EIX	490470
SM 500 R	500	16-	CR8EB	384085	CR8EIX	490470
Superdual T	600	17-	CR8EB	384085	CR8EIX	490470
Superdual X	600	17-	CR8EB	384085	CR8EIX	490470
TL 200	200	-	BP5ES	490456	BPR5EIX	511478
TL 240	240	-	BP5ES	490456	BPR5EIX	511478
TL 350	350	-	BP5ES	490456	BPR5EIX	511478
TLM 125	125	-	BP5ES	490456	BPR5EIX	511478
TLM 320	320	-	BP5ES	490456	BPR5EIX	511478
SYM						
500 GT	500	04-	CR7EKB	450805	CR7EIX	490469
500 XP	500	04-	CR7EKB	450805	CR7EIX	490469
Allo 125	125	11-16	CR7HSA	1861	CR7HIX	496398
Attila 125	125	98-00	CR7HSA	1861	CR7HIX	496398
Citycom 125	125	-	CR7E	213902	CR7EIX	490469
Citycom 300i	300	-	CR8E	1862	CR8EIX	490470
Citycom S 300i	300	-	CR8E	1862	CR8EIX	490470
Crox 125	125	15-	CR7HSA	1861	CR7HIX	496398
Cruisym 300i	300	17-	CR8E	1862	CR8EIX	490470
CT 125	125	04-	DR8EA	198225	DR8EIX	493825
Euro MX 125	125	-	CR8E	1862	CR8EIX	490470
Euro MX 125 4V	125	05-	CR8E	1862	CR8EIX	490470
Fiddle II 125	125	08-14	CR7HSA	1861	CR7HIX	496398
Fiddle II 150	150	10-	CR7HSA	1861	CR7HIX	496398
Fiddle III 125	125	14-	CR7HSA	1861	CR7HIX	496398
GTS 125	125	06-	CR8E	1862	CR8EIX	490470
GTS 125 E2	125	-	CR8E	1862	CR8EIX	490470
GTS 125 E3	125	-	CR8E	1862	CR8EIX	490470
GTS 125 Voyager	125	05-	CR8E	1862	CR8EIX	490470
GTS 125i	125	-	CPR8EA-9	496384	CPR8EAIX-9	506203
GTS 125i	125	-	CPR8EA-9	496384	CPR8EAIX-9	506203
GTS 250	250	06-	CR8E	1862	CR8EIX	490470
GTS 250 E2	250	-	CR8E	1862	CR8EIX	490470
GTS 250i E3	250	-	CR8E	1862	CR8EIX	490470
GTS 300	300	-	CR8E	1862	CR8EIX	490470
GTS 300i	300	-	CR8E	1862	CR8EIX	490470
GTS 300i EVO	300	-	CR8E	1862	CR8EIX	490470
GTS Sport 125i	125	-	CPR8EA-9	496384	CPR8EAIX-9	506203
GTS Sport 300i	300	-	CR8E	1862	CR8EIX	490470
GTS Voyager 125	125	-	CR8E	1862	CR8EIX	490470
HD 125	125	-04	DR8EA	198225	DR8EIX	493825
HD 125	125	05-08	CR8E	1862	CR8EIX	490470





Modèle	Cylindrée	Année	NOK		NOK	
			Bougie	Ref CGN standard	Bougie iridium	Ref CGN iridium
HD 125 EVO	125	08-	CR7E	213902	CR7EIX	490469
HD 125 Orbit	125	04-	CR8E	1862	CR8EIX	490470
HD 2	125	10-	CR8E	1862	CR8EIX	490470
HD 2	200	10-	CR7E	213902	CR7EIX	490469
HD 200	200	05-	CR8E	1862	CR8EIX	490470
HD 200 dd E2	200	-	CR8E	1862	CR8EIX	490470
HD 200i EVO E3	200	-	CR7E	213902	CR7EIX	490469
HD Orbit 180	180	04-	CR8E	1862	CR8EIX	490470
Husky 125	125	97-	DR8EA	198225	DR8EIX	493825
Jet 4 125	125	-	CR7HSA	1861	CR7HIX	496398
Jet V 125	125	-	CR7HSA	1861	CR7HIX	496398
Jet14 125i	125	-	CR7HSA	1861	CR7HIX	496398
Joymax 250	250	06-	CR8E	1862	CR8EIX	490470
Joymax 300i	300	-	CR8E	1862	CR8EIX	490470
Joymax Evo 300	300	08-	CR8E	1862	CR8EIX	490470
Joymax Sport 125i	125	-	CPR8EA-9	496384	CPR8EAIX-9	506203
Joymax Sport 300i	300	-	CR8E	1862	CR8EIX	490470
Joyride 125	125	-02	CR8E	1862	CR8EIX	490470
Joyride 125	125	03-04	CR7HSA	1861	CR7HIX	496398
Joyride 125 E2	125	05-	CR8E	1862	CR8EIX	490470
Joyride 125 E3	125	05-	CR8E	1862	CR8EIX	490470
Joyride 125 Evo	125	05-	CR8E	1862	CR8EIX	490470
Joyride 150	150	-	CR8E	1862	CR8EIX	490470
Joyride 180	180	02-	CR8E	1862	CR8EIX	490470
Joyride 200	200	05-	CR8E	1862	CR8EIX	490470
Joyride S 125i	125	-	CPR8EA-9	496384	CPR8EAIX-9	506203
MaxSym 200	200	10-	CR8E	1862	CR8EIX	490470
MaxSym 400	400	10-16	CR8E	1862	CR8EIX	490470
MaxSym 400i	400	-	CPR8EA-9	496384	CPR8EAIX-9	506203
MaxSym 600i	600	-	CR8E	1862	CR8EIX	490470
Megalo 125	125	01-	CR7HSA	1861	CR7HIX	496398
MG 125 Megalo	125	-	CR7HSA	1861	CR7HIX	496398
Orbit 125	125	-	CR7HSA	1861	CR7HIX	496398
Orbit II 125	125	-	CR7HSA	1861	CR7HIX	496398
Retro 125	125	05-	CR7HSA	1861	CR7HIX	496398
RS 125 4V	125	05-	CR8E	1862	CR8EIX	490470
Shark 125	125	99-	CR8E	1862	CR8EIX	490470
SK 125	125	01-	CR8E	1862	CR8EIX	490470
Stealth 125	125	05-	CR7HSA	1861	CR7HIX	496398
Super Duke 125	125	96-	CR7HSA	1861	CR7HIX	496398
Symphony 125	125	09-	CR7HSA	1861	CR7HIX	496398
Symphony 150	150	10-	CR7HSA	1861	CR7HIX	496398



Modèle	Cylindrée	Année	Bougie	 		
				Ref CGN standard	Bougie iridium	Ref CGN iridium
Symply 125	125	09-	CR7HSA	1861	CR7HIX	496398
Symply II 125	125	09-	CR7HSA	1861	CR7HIX	496398
VS 125	125	-	CR7E	213902	CR7EIX	490469
VS 150	150	07-	CR8E	1862	CR8EIX	490470
Wolf 125	125	05-09	DR8EA	198225	DR8EIX	493825
Wolf 125	125	10-	DR7EA	496396	DR7EIX	512413
X-Pro 125i	125	-	CR7HSA	1861	CR7HIX	496398
XS 125-K	125	-	DR8EA	198225	DR8EIX	493825
TGB (TAIWAN GOLDEN BEE)						
202T Palio	125	98-	CR7HSA	1861	CR7HIX	496398
202T Palio	125	98-	C7HSA	465600	CR7HIX	496398
204 Classic	125	02-07	CR7HSA	1861	CR7HIX	496398
303 R	125	-	CR7HSA	1861	CR7HIX	496398
303 R Hawk	125	07-	CR7HSA	1861	CR7HIX	496398
303R	150	-	CR7HSA	1861	CR7HIX	496398
304 Sport	125	02-	CR7HSA	1861	CR7HIX	496398
309 RS	125	-	CR7HSA	1861	CR7HIX	496398
309RS	150	-	CR7HSA	1861	CR7HIX	496398
404 Executive	125	02-07	CR7HSA	1861	CR7HIX	496398
Delivery	125	05-	CR7HSA	1861	CR7HIX	496398
F409	125	-	CR7HSA	1861	CR7HIX	496398
F409 / Laser	150	-	CR7HSA	1861	CR7HIX	496398
Laser	125	-	CR7HSA	1861	CR7HIX	496398
RI25X	125	08-	CR7HSA	1861	CR7HIX	496398
TM						
Cross 125	125	94-	BR9EG	1892	-	-
Cross 125	125	94-	B10EG	1870	-	-
Cross 250	250	94-	BR8EG	214162	-	-
Cross 250	250	94-	B9EG	1869	-	-
Cross 300	300	94-	BR9EG	1892	-	-
Cross 300	300	-	B9EG	1869	-	-
Cross 400	400	02-	CR8E	1862	CR8EIX	490470
EN 125	125	03-	BR9EG	1892	BR9EIX	381511
EN 250	250	03-	BR8EG	214162	-	-
EN 250	250	05-	CR8E	1862	CR8EIX	490470
EN 250	250	05-	BR8EG	214162	-	-
EN 250 Cross	250	01-	CR8E	1862	CR8EIX	490470
EN 250 Enduro	250	01-	CR8E	1862	CR8EIX	490470
EN 250 F	250	04-	CR8E	1862	CR8EIX	490470
EN 300	300	03-	BR8EG	214162	-	-
EN 450	450	05-	CR8E	1862	CR8EIX	490470
EN 450 F	450	04-	CR8E	1862	CR8EIX	490470





Modèle	Cylindrée	Année	NOK		NOK	
			Bougie	Ref CGN standard	Bougie iridium	Ref CGN iridium
EN 530	530	05-	CR8E	1862	CR8EIX	490470
Enduro 125	125	94-	BR9EG	1892	-	-
Enduro 125	125	94-	B10EG	1870	-	-
Enduro 250	250	94-	BR8EG	214162	-	-
Enduro 250	250	94-	B9EG	1869	-	-
Enduro 300	300	94-	BR9EG	1892	-	-
Enduro 300	300	-	B9EG	1869	-	-
Enduro 400	400	02-	CR8E	1862	CR8EIX	490470
MX 125 Racing	125	05-	BR9EG	1892	-	-
MX 450 Racing	450	05-	CR8E	1862	CR8EIX	490470
MX 530 Racing	530	05-	CR8E	1862	CR8EIX	490470
TRIUMPH						
Adventurer 900	900	96-01	DPR8EA-9	1857	DPR8EIX-9	496388
America	790	02-06	DPR8EA-9	1857	DPR8EIX-9	496388
America 865	865	06-	DPR8EA-9	1857	DPR8EIX-9	496388
Bonneville	790	02-04	DPR8EA-9	1857	DPR8EIX-9	496388
Bonneville 1200 EFI	1200	16-	LMAR8A-9	496405	-	-
Bonneville 800	800	01-06	DPR8EA-9	1857	DPR8EIX-9	496388
Bonneville 865	865	05-16	DPR8EA-9	1857	DPR8EIX-9	496388
Bonneville 900 EFI	900	17-	LMAR8A-9	496405	-	-
Bonneville America	790	02-06	DPR8EA-9	1857	DPR8EIX-9	496388
Bonneville Black	790	00-06	DPR8EA-9	1857	DPR8EIX-9	496388
Daytona 1200	1200	93-00	DPR8EA-9	1857	DPR8EIX-9	496388
Daytona 600	600	03-04	CR9EK	213936	CR9EIX	381550
Daytona 650	650	04-05	CR9EK	213936	CR9EIX	381550
Daytona 675	675	06-12	CR9EK	213936	CR9EIX	381550
Daytona 675	675	13-	CR9EIA-9	496379	-	-
Daytona 675 R	675	11-12	CR9EIA-9	496379	-	-
Daytona 675 R	675	13-	CR9EIA-9	496379	-	-
Daytona 675 RR	675	06-08	CR9EK	213936	CR9EIX	381550
Daytona 750	750	91-98	DPR8EA-9	1857	DPR8EIX-9	496388
Daytona 900	900	91-96	DPR8EA-9	1857	DPR8EIX-9	496388
Daytona 900 Super III	900	94-96	DPR8EA-9	1857	DPR8EIX-9	496388
Daytona 955i	955	97-01	DPR8EA-9	1857	DPR8EIX-9	496388
Daytona 955i	955	02-06	CR9EK	213936	CR9EIX	381550
HM 1050	1050	07-	CR9EK	213936	CR9EIX	381550
Legend 900 TT	900	98-01	DPR9EA-9	1860	DPR9EIX-9	512585
Rocket 2300 III	2300	04-	DPR7EA-9	198282	DPR7EIX-9	512580
Rocket 2300 III Classic	2300	06-	DPR7EA-9	198282	DPR7EIX-9	512580
Rocket 2300 III Roadster	2300	09-	DPR7EA-9	198282	DPR7EIX-9	512580
Rocket 2300 III Touring	2300	08-	DPR7EA-9	198282	DPR7EIX-9	512580
Scrambler 865	865	06-	DPR8EA-9	1857	DPR8EIX-9	496388

Modèle	Cylindrée	Année	Bougie	 		
				Ref CGN standard	Bougie iridium	Ref CGN iridium
Scrambler 900	900	06-	DPR8EA-9	1857	DPR8EIX-9	496388
Speed 1050 Triple	1050	05-	CR8EK	461666	CR8EIX	490470
Speed 94	1050	15-	CR8EK	461666	CR8EIX	490470
Speed 94R	1050	15-	CR8EK	461666	CR8EIX	490470
Speed Four 600	600	02-05	CR9EK	213936	CR9EIX	381550
Speed Triple 750	750	94-97	DPR8EA-9	1857	DPR8EIX-9	496388
Speed Triple 900	900	94-96	DPR8EA-9	1857	DPR8EIX-9	496388
Speed Triple 900	900	97-	DPR8EA-9	1857	DPR8EIX-9	496388
Speed Triple 955	955	98-01	DPR8EA-9	1857	DPR8EIX-9	496388
Speed Triple 955	955	02-04	CR9EK	213936	CR9EIX	381550
Speed Triple S 600	600	02-	CR9EK	213936	CR9EIX	381550
Speedmaster	790	01-	DPR8EA-9	1857	DPR8EIX-9	496388
Speedmaster 865	865	05-	DPR8EA-9	1857	DPR8EIX-9	496388
Speedmaster 900	900	05-	DPR8EA-9	1857	DPR8EIX-9	496388
Sprint 1050 GT	1050	10-	CR8EK	461666	CR8EIX	490470
Sprint 1050 ST	1050	05-	CR8EK	461666	CR8EIX	490470
Sprint 1050 ST	1050	05-	CR8EK	461666	CR8EIX	490470
Sprint 900	900	93-96	DPR8EA-9	1857	DPR8EIX-9	496388
Sprint 955 RS	955	99-00	DPR8EA-9	1857	DPR8EIX-9	496388
Sprint 955 RS	955	01-05	CR9EK	213936	CR9EIX	381550
Sprint 955 ST	955	98-00	DPR8EA-9	1857	DPR8EIX-9	496388
Sprint 955 ST	955	01-	CR9EK	213936	CR9EIX	381550
Street Cup 900 EFI	900	17-	LMAR8A-9	496405	-	-
Street Triple 675	675	07-11	CR9EK	213936	CR9EIX	381550
Street Triple 675 R	675	08-11	CR9EK	213936	CR9EIX	381550
Street Twin 900 EFI	900	16-	LMAR8A-9	496405	-	-
T 140 750 TSS	750	82-	C8E	512606	CR8EIX	490470
T 140 750 TSX	750	82-	C8E	512606	CR8EIX	490470
Thruxton 1200 EFI	1200	16-	LMAR8A-9	496405	-	-
Thruxton 1200 R EFI	1200	16-	LMAR8A-9	496405	-	-
Thruxton 865	865	03-15	DPR8EA-9	1857	DPR8EIX-9	496388
Thruxton 865 SE	865	10-	DPR8EA-9	1857	DPR8EIX-9	496388
Thruxton 900	900	04-	DPR8EA-9	1857	DPR8EIX-9	496388
Thunderbird 1600	1600	09-	DPR6EA-9	490471	-	-
Thunderbird 1700 LT	1700	14-	DPR6EA-9	490471	-	-
Thunderbird 900	900	95-04	DPR8EA-9	1857	DPR8EIX-9	496388
Thunderbird 900 Sport	900	98-04	DPR8EA-9	1857	DPR8EIX-9	496388
Thunderbird Commander 1700	1700	14-	DPR6EA-9	490471	-	-
Thunderbird Storm 1600	1600	09-	DPR6EA-9	490471	-	-
Thunderbird Storm 1700	1700	11-	DPR6EA-9	490471	-	-
Tiger	790	91-98	DPR8EA-9	1857	DPR8EIX-9	496388
Tiger 1050	1050	06-	CR8EK	461666	CR8EIX	490470



Modèle	Cylindrée	Année	Bougie	 		
				Ref CGN standard	Bougie iridium	Ref CGN iridium
Tiger 1050	1050	06-	CR8EK	461666	CR8EIX	490470
Tiger 1200	1200	12-	CR8EK	461666	CR8EIX	490470
Tiger 800	800	10-	CR9EK	213936	CR9EIX	381550
Tiger 800 XC	800	10-	CR9EK	213936	CR9EIX	381550
Tiger 800 XRT	800	15-	CR9EK	213936	CR9EIX	381550
Tiger 900	900	93-98	DPR8EA-9	1857	DPR8EIX-9	496388
Tiger 900 - T709	900	98-01	DPR8EA-9	1857	DPR8EIX-9	496388
Tiger 955i	955	01-07	DPR8EA-9	1857	DPR8EIX-9	496388
Tiger Sport 1050	1050	13-	CR8EK	461666	CR8EIX	490470
Trident 750	750	91-98	DPR8EA-9	1857	DPR8EIX-9	496388
Trident 900	900	91-98	DPR8EA-9	1857	DPR8EIX-9	496388
Trophy 1200	1200	91-03	DPR8EA-9	1857	DPR8EIX-9	496388
Trophy 1200	1200	12-	CR8EK	461666	CR8EIX	490470
Trophy 900	900	91-95	DPR8EA-9	1857	DPR8EIX-9	496388
TT 600	600	99-03	CR9EK	213936	CR9EIX	381550
URAL RETRO						
Deco Cruiser / Italia Cruiser	648	97-	BP4HS	500653	-	-
IMZ-10, IMZ-40, IMZ-50	650	-	BP4HS	500653	-	-
M3-8.103	650	-	BP5HS	512590	-	-
M3-8.123	650	-	BP6ES	490457	BPR6EIX	512415
Solo Cruiser / Sportsman Classic	648	97-	BP4HS	500653	-	-
Solo Single / Sportsman / Tourist Sidecar	650	94-96	BP4HS	500653	-	-
Tourist	750	-	B7HS	1835	BR7HIX	497113
Tourist Classic	648	97-	BP4HS	500653	-	-
Ural	745	-	BP7HS	490460	BPR7HIX	497112
V.O.R.						
Cross	400	00-	CR7EK	512551	CR7EIX	490469
Cross	450	00-	CR7EK	512551	CR7EIX	490469
Cross	500	02-	CR8EK	461666	CR8EIX	490470
Cross	530	01-	CR7EK	512551	CR7EIX	490469
Enduro	400	00-	CR7EK	512551	CR7EIX	490469
Enduro	450	00-	CR7EK	512551	CR7EIX	490469
Enduro	501	02-	CR8EK	461666	CR8EIX	490470
Enduro	530	99-	CR7EK	512551	CR7EIX	490469
EN-MAR	530	04-	CR8EK	461666	CR8EIX	490470
EN-MAR, ENE	450	04-	CR8EK	461666	CR8EIX	490470
Super Motard	400	00-	CR7EK	512551	CR7EIX	490469
Super Motard	501	02-	CR8EK	461666	CR8EIX	490470
Super Motard	503	99-	CR7EK	512551	CR7EIX	490469
Super Motard Compétition	530	99-	CR7EK	512551	CR7EIX	490469
VERTEMATI						
E 450	503	09-	CR9EK	213936	CR9EIX	381550

Modèle	Cylindrée	Année	Bougie	 		
				Ref CGN standard	Bougie iridium	Ref CGN iridium
E 450 E	503	09-	CR9EK	213936	CR9EIX	381550
E 501	503	09-	CR9EK	213936	CR9EIX	381550
E 501 E	503	09-	CR9EK	213936	CR9EIX	381550
E 570	503	09-	CR9EK	213936	CR9EIX	381550
E 570 E	503	09-	CR9EK	213936	CR9EIX	381550
S 501	500	09-	CR9EK	213936	CR9EIX	381550
S 570	570	03-	CR9EK	213936	CR9EIX	381550
SR 501	500	09-	CR9EK	213936	CR9EIX	381550
VICTORY						
8-Ball	1500	05-	CPR6EB-9	512497	-	-
8-Ball	1700	11-	DCPR6E	512493	DCPR6EIX	512429
Arlen Ness Vision	1731	10-	DCPR6E	512493	DCPR6EIX	512429
Broadwalk	1731	13-	DCPR6E	512493	DCPR6EIX	512429
Classic Cruiser	1500	03-	CPR6EB-9	512497	-	-
Cory Ness Jackpot	1731	10-	DCPR6E	512493	DCPR6EIX	512429
Cross Country	1700	11-	DCPR6E	512493	DCPR6EIX	512429
Cross Country	1731	10-	DCPR6E	512493	DCPR6EIX	512429
Cross Country Tour	1731	10-	DCPR6E	512493	DCPR6EIX	512429
Cross Roads	1731	10-	DCPR6E	512493	DCPR6EIX	512429
Cruiser	1500	98-01	DCPR6E	512493	DCPR6EIX	512429
Cruiser	1500	02-	CPR6EB-9	512497	-	-
Hammer	1500	05-	CPR6EB-9	512497	-	-
Hammer	1634	06-	CPR6EB-9	512497	-	-
Hammer	1700	11-	DCPR6E	512493	DCPR6EIX	512429
Hammer 8-Ball	1634	05-	CPR6EB-9	512497	-	-
Hammer S	1731	08-	DCPR6E	512493	DCPR6EIX	512429
Jackpot	1700	11-	DCPR6E	512493	DCPR6EIX	512429
Kingpin	1500	04-05	CPR6EB-9	512497	-	-
Kingpin	1634	06-	CPR6EB-9	512497	-	-
Kingpin	1634	08-	DCPR6E	512493	DCPR6EIX	512429
Kingpin 8-Ball	1634	05-	CPR6EB-9	512497	-	-
Kingpin 8-Ball	1634	08-	DCPR6E	512493	DCPR6EIX	512429
Kingpin Ness Signature	1500	05-	CPR6EB-9	512497	-	-
Ness Signature Jackpot	1634	06-	CPR6EB-9	512497	-	-
S Suede	1700	11-	DCPR6E	512493	DCPR6EIX	512429
Spezial Edition	1500	00-	DCPR6E	512493	DCPR6EIX	512429
Sport Cruiser	1500	00-01	DCPR6E	512493	DCPR6EIX	512429
Standard Cruiser	1500	99-02	DCPR6E	512493	DCPR6EIX	512429
Touring Cruiser	1500	00-01	DCPR6E	512493	DCPR6EIX	512429
Touring Cruiser	1500	02-05	CPR6EB-9	512497	-	-
Touring Cruiser	1634	06-	CPR6EB-9	512497	-	-
V92C	1507	99-01	DCPR6E	512493	DCPR6EIX	512429





Modèle	Cylindrée	Année	Bougie	NOK		
				Ref CGN standard	Ref CGN iridium	
V92C	1507	02-04	CPR6EB-9	512497	-	
Vegas	1500	03-05	CPR6EB-9	512497	-	
Vegas	1634	05-	CPR6EB-9	512497	-	
Vegas 8-Ball	1634	05-	CPR6EB-9	512497	-	
Vegas ANSS	1500	04-	CPR6EB-9	512497	-	
Vegas Jackpot	1634	05-	CPR6EB-9	512497	-	
Vegas Jackpot	1634	06-	CPR6EB-9	512497	-	
Vegas Jackpot	1731	08-	DCPR6E	512493	DCPR6EIX	
Vegas Low	1631	08-	DCPR6E	512493	DCPR6EIX	
Vegas Ness Signature	1500	05-	CPR6EB-9	512497	-	
Vision	1731	08-	DCPR6E	512493	DCPR6EIX	
Vision Tour ABS	1700	11-	DCPR6E	512493	DCPR6EIX	
Zach Ness Cross Vegas SL	1700	11-	DCPR6E	512493	DCPR6EIX	
YAMAHA						
AC 150 B	153	09-09	CPR8EA-9	496384	CPR8EAIX-9	
AG 175	175	-	B8ES	1843	BR8EIX	
AG 175 H	175	-	B7ES	1842	BR7EIX	
AG 200 E	200	93-	D8EA	1855	DR8EIX	
AG 200 F, FE	200	07-09	D8EA	1855	DR8EIX	
AT 135	132	08-09	CR7E	213902	CR7EIX	
AT 135 Cast, Spoke	132	08	CR7E	213902	CR7EIX	
BT 1100 Bulldog	1100	02-06	BPR7ES	1848	BPR7EIX	
BW 200	200	-	D8EA	1855	DR8EIX	
BW 350	350	-	DR8ES-L	1859	DR8EIX	
BWS 125	125	09-	CR7HSA	1861	CR7HIX	
BWS 125	125	09-	CR7HSA	1861	CR7HIX	
BWS 125	125	10-	CR7E	213902	CR7EIX	
CP 250	250	07-08	CPR7EA-9	496389	CPR7EAIX-9	
CP 250 W Morphous	250	07-	CPR7EA-9	496389	CPR7EAIX-9	
CS5 200	200	72-	B8HS	1837	BR8HIX	
CZD 300 X-MAX	300	17-	LMAR8A-9	496405	-	
Doodo 125	125	01-	CR8E	1862	CR8EIX	
DT 125	125	88-	BR9ES	1890	BR9EIX	
DT 125	125	94-	B8ES	1843	BR8EIX	
DT 125	125	07-09	B8ES	1843	BR8EIX	
DT 125 ED	125	-	B8ES	1843	BR8EIX	
DT 125 F	125	-	B8ES	1843	BR8EIX	
DT 125 H	125	-	B8ES	1843	BR8EIX	
DT 125 LC	125	86-	BR9ES	1890	BR9EIX	
DT 125 MX	125	-	B8ES	1843	BR8EIX	
DT 125 R	125	90-	BR9ES	1890	BR9EIX	
DT 125 R	125	01-04	BR8ES	1889	BR8EIX	

Modèle	Cylindrée	Année	NGK		NGK	
			Bougie	Ref CGN standard	Bougie iridium	Ref CGN iridium
DT 125 RE	125	90-	BR9ES	1890	BR9EIX	381511
DT 125 RE	125	04-	BR8ES	1889	BR8EIX	381507
DT 125 Tenere	125	-	B9ES	1844	BR9EIX	381511
DT 125 X	125	05-	BR8ES	1889	BR8EIX	381507
DT 165 R	165	91-	BR8ES	1889	BR8EIX	381507
DT 175	175	07-09	B8ES	1843	BR8EIX	381507
DT 175 E, F, H	175	-	B8ES	1843	BR8EIX	381507
DT 200 LC, RE, RF	200	93-	BR9ES	1890	BR9EIX	381511
DT 200 R	200	-	BR9ES	1890	BR9EIX	381511
DT 250 E	250	-	B8ES	1843	BR8EIX	381507
DT 250 H	250	-	B8ES	1843	BR8EIX	381507
DT 400 E	400	-	B9ES	1844	BR9EIX	381511
DT 400 H	400	-	B8ES	1843	BR8EIX	381507
FJ 1200	1200	91-	DPR8EA-9	1857	DPR8EIX-9	496388
FJ 1200 AE	1200	93-	DP8EA-9	214029	DPR8EIX-9	496388
FJ 1200 AEC	1200	93-	DP8EA-9	214029	DPR8EIX-9	496388
FJ 1200 E	1200	93-	DP8EA-9	214029	DPR8EIX-9	496388
FJ 1200 F	1200	93-	DP8EA-9	214029	DPR8EIX-9	496388
FJR 1300	1300	01-05	CR8E	1862	CR8EIX	490470
FJR 1300	1300	13-	CPR8EA-9	496384	CPR8EAIX-9	506203
FJR 1300 A	1300	03-12	CR8E	1862	CR8EIX	490470
FJR 1300 A	1300	13-	CPR8EA-9	496384	CPR8EAIX-9	506203
FJR 1300 AE	1300	14-	CPR8EA-9	496384	CPR8EAIX-9	506203
FJR 1300 AEX	1300	08-08	CR8E	1862	CR8EIX	490470
FJR 1300 AEXC	1300	08-08	CR8E	1862	CR8EIX	490470
FJR 1300 AP	1300	07-09	CR8E	1862	CR8EIX	490470
FJR 1300 AS	1300	06-12	CR8E	1862	CR8EIX	490470
FJR 1300 AS	1300	13-	CPR8EA-9	496384	CPR8EAIX-9	506203
FJR 1300 ASX	1300	08-08	CR8E	1862	CR8EIX	490470
FJR 1300 ASY	1300	09-09	CR8E	1862	CR8EIX	490470
FJR 1300 AW	1300	07-07	CR8E	1862	CR8EIX	490470
FJR 1300 AX	1300	07-07	CR8E	1862	CR8EIX	490470
FJR 1300 AY	1300	09-09	CR8E	1862	CR8EIX	490470
FZ 150	125	08-08	CR8E	1862	CR8EIX	490470
FZ 150 / FZR 150	150	94-	C7HSA	465600	CR7HIX	496398
FZ 600	600	-	DR8ES-L	1859	DR8EIX	493825
FZ 600 U	600	-	DR8ES-L	1859	DR8EIX	493825
FZ 750	750	91-	DR8ES-L	1859	DR8EIX	493825
FZI	1000	06-07	CR9EK	213936	CR9EIX	381550
FZI	1000	08-08	CR9EK	213936	CR9EIX	381550
FZI Fazer	1000	06-07	CR9EK	213936	CR9EIX	381550
FZI Fazer	1000	08-08	CR9EK	213936	CR9EIX	381550



Modèle	Cylindrée	Année	NOK		NOK	
			Bougie	Ref CGN standard	Bougie iridium	Ref CGN iridium
FZ1 N	1000	06-10	CR9EK	213936	CR9EIX	381550
FZ1 N	1000	11-15	CR9E	1863	CR9EIX	381550
FZ1 NA	1000	11-15	CR9E	1863	CR9EIX	381550
FZ1 NA	1000	08-10	CR9EK	213936	CR9EIX	381550
FZ1 NX	1000	08-08	CR9EK	213936	CR9EIX	381550
FZ1 NY	1000	09-09	CR9EK	213936	CR9EIX	381550
FZ1 S	1000	06-10	CR9EK	213936	CR9EIX	381550
FZ1 S Fazer	1000	11-15	CR9E	1863	CR9EIX	381550
FZ1 SA	1000	07-10	CR9EK	213936	CR9EIX	381550
FZ1 SA	1000	10-	CR9EK	213936	CR9EIX	381550
FZ1 SA Fazer	1000	11-15	CR9E	1863	CR9EIX	381550
FZ1 SX	1000	08-08	CR9EK	213936	CR9EIX	381550
FZ1 SY	1000	09-09	CR9EK	213936	CR9EIX	381550
FZ6 600 Fazer	600	04-	CR9EK	213936	CR9EIX	381550
FZ6 600 Fazer	600	03-06	CR9EK	213936	CR9EIX	381550
FZ6 600 Fazer	600	10-	CR9E	1863	CR9EIX	381550
FZ6 600 Fazer S2	600	07-	CR9EK	213936	CR9EIX	381550
FZ6 600 N 4T	600	04-07	CR9EK	213936	CR9EIX	381550
FZ6 600 NA	600	07-07	CR9EK	213936	CR9EIX	381550
FZ6 600 NAHG	600	07-07	CR9EK	213936	CR9EIX	381550
FZ6 600 NAHG	600	08-09	CR9EK	213936	CR9EIX	381550
FZ6 600 NHG 4T	600	06-09	CR9EK	213936	CR9EIX	381550
FZ6 600 NHGY	600	09-09	CR9EK	213936	CR9EIX	381550
FZ6 600 S 4T	600	04-08	CR9EK	213936	CR9EIX	381550
FZ6 600 SA 4T	600	06-08	CR9EK	213936	CR9EIX	381550
FZ6 600 SAHG 4T	600	07-09	CR9EK	213936	CR9EIX	381550
FZ6 600 SHG 4T	600	07-09	CR9EK	213936	CR9EIX	381550
FZ6 600 SHGW	600	07-07	CR9EK	213936	CR9EIX	381550
FZ6 600 SHGX	600	08-08	CR9EK	213936	CR9EIX	381550
FZ6 600 SHGY	600	09-09	CR9EK	213936	CR9EIX	381550
FZ8	800	10-	CR9E	1863	CR9EIX	381550
FZ8 N	800	10-	CR9E	1863	CR9EIX	381550
FZ8 N	800	11-15	CR9E	1863	CR9EIX	381550
FZ8 NA	800	11-16	CR9E	1863	CR9EIX	381550
FZ8 Redline	800	12-	CR9E	1863	CR9EIX	381550
FZ8 S	800	10-	CR9E	1863	CR9EIX	381550
FZ8 S Facer	800	11-15	CR9E	1863	CR9EIX	381550
FZ8 SA	800	10-	CR9E	1863	CR9EIX	381550
FZ8 SA Facer	800	11-15	CR9E	1863	CR9EIX	381550
FZR 1000 EXUP	1000	94-95	DR8EA	198225	DR8EIX	493825
FZR 1000 F	1000	94-	DP8EA-9	214029	DPR8EIX-9	496388
FZR 1000 FC	1000	94-	DR8EA	198225	DR8EIX	493825

Modèle	Cylindrée	Année	Bougie	 		
				Ref CGN standard	Bougie iridium	Ref CGN iridium
FZR 1000 U	1000	94-	DP8EA-9	214029	DPR8EIX-9	496388
FZR 1000 U	1000	-	DR8ES-L	1859	DR8EIX	493825
FZR 400	400	87-	CR8E	1862	CR8EIX	490470
FZR 400 RR	400	91-95	CR8E	1862	CR8EIX	490470
FZR 400 SP	400	91-95	CR8E	1862	CR8EIX	490470
FZR 600 F	600	94-	CR9E	1863	CR9EIX	381550
FZR 600 R	600	94-	CR9E	1863	CR9EIX	381550
FZR 600 RF	600	94-	CR9E	1863	CR9EIX	381550
FZR 600 RFC	600	94-	CR9E	1863	CR9EIX	381550
FZR 750 R	750	89-	DR9EA	214048	DR9EIX	512583
FZS 1000 Fazer	1000	00-	CR9E	1863	CR9EIX	381550
FZS 1000 Fazer	1000	01-	CR9E	1863	CR9EIX	381550
FZS 1000 Fazer EXUP	1000	00-05	CR9E	1863	CR9EIX	381550
FZS 1000 Fazer EXUP	1000	00-05	CR9E	1863	CR9EIX	381550
FZS 1000 S Fazer EXUP	1000	03-05	CR9E	1863	CR9EIX	381550
FZS 1000 S Fazer EXUP	1000	03-05	CR9E	1863	CR9EIX	381550
FZS 600 Fazer	600	03-04	CR9EK	213936	CR9EIX	381550
FZS 600 H Fazer	600	98-02	CR9E	1863	CR9EIX	381550
FZS 600 N Fazer	600	98-02	CR8E	1862	CR8EIX	490470
FZX 750 Phaser	750	-	DR8ES-L	1859	DR8EIX	493825
GTS 1000	1000	92-	DPR8EA-9	1857	DPR8EIX-9	496388
GTS 1000 A	1000	92-	DPR8EA-9	1857	DPR8EIX-9	496388
HL 500	500	-	BPR7ES	1848	BPR7EIX	512582
HW 125 Xenter	125	12-	CPR9EA-9	465889	CPR9EAIX-9	512434
HW 150 Xenter	150	12-	CPR9EA-9	465889	CPR9EAIX-9	512434
IT 125 G	125	80-	B9EG	1869	BR9EIX	381511
IT 125 H	125	81-	B9EG	1869	BR9EIX	381511
IT 175 E	175	-	-	-	BR10EIX	381617
IT 175 H, J, K	175	-	B9EG	1869	-	-
IT 200	200	-	BR9EG	1892	-	-
IT 200 S	200	-	BR9EG	1892	BR9EIX	381511
IT 250	250	81-	B8EG	198244	-	-
IT 250	250	85-	B9EG	1869	-	-
IT 250 H	250	-	B9EG	1869	-	-
IT 250 J	250	-	B9EG	1869	-	-
IT 250 K	250	-	B9EG	1869	-	-
IT 250 N	250	-	BR9EG	1892	BR9EIX	381511
IT 400	400	-	B8ES	1843	BR8EIX	381507
IT 400 E	400	-	-	-	BR8EIX	381507
IT 425	425	-	B8ES	1843	BR8EIX	381507
IT 465	465	81-	B8ES	1843	BR8EIX	381507
IT 465 H	465	-	B8ES	1843	BR8EIX	381507



Modèle	Cylindrée	Année	Bougie			
				Ref CGN standard	Ref CGN iridium	
IT 465 J	465	-	B8ES	1843	BR8EIX	381507
IT 500	500	-	BPR7ES	1848	BPR7EIX	512582
JT 135	135	07-08	CPR8EA-9	496384	CPR8EAIX-9	506203
Majesty 125	125	-	DR8EA	198225	DR8EIX	493825
MT 03 660	660	06-07	CR7E	213902	CR7EIX	490469
MT 03 660	660	08-	CR7E	213902	CR7EIX	490469
MT-011000	1000	07-	DPR7EA-9	198282	DPR7EIX-9	512580
MT-011700	1670	05-	DPR7EA-9	198282	DPR7EIX-9	512580
MT-011700	1670	09-	DPR7EA-9	198282	DPR7EIX-9	512580
MT-011700 S	1670	09-	DPR7EA-9	198282	DPR7EIX-9	512580
MT-011700 W	1670	07-07	DPR7EA-9	198282	DPR7EIX-9	512580
MT-011700 X	1670	08-08	DPR7EA-9	198282	DPR7EIX-9	512580
MT-03 4T	320	16-17	CR8E	1862	CR8EIX	490470
MT-03 4T	320	18-	LMAR8A-9	496405	-	-
MT-07	700	14-	LMAR8A-9	496405	-	-
MT-07 Tracer 700	700	16-	LMAR8A-9	496405	-	-
MT-09 850	850	13-15	CPR9EA-9	465889	CPR9EAIX-9	512434
MT-09 Tracer 900	850	16-	CPR9EA-9	465889	CPR9EAIX-9	512434
MT-09 Tracer 900 GT	850	16-	CPR9EA-9	465889	CPR9EAIX-9	512434
MT-10 4T	1000	16-	LMAR9E-J	512569	-	-
MT-10 SP 4T	1000	17-	LMAR9E-J	512569	-	-
MT-10 Tourer Edition 4T	1000	18-	LMAR9E-J	512569	-	-
MT-125 4T	125	14-	CR9E	1863	CR9EIX	381550
MX 125	125	-	-	-	BR9EIX	381511
MX 175	175	-	B8ES	1843	BR8EIX	381507
MX 175 B	175	-	-	-	BR8EIX	381507
MX 175 H	175	-	B8ES	1843	BR8EIX	381507
MX 250	250	-	-	-	BR8EIX	381507
MX 360	360	-	-	-	BR8EIX	381507
MX 400	400	-	-	-	BR8EIX	381507
MX 500	500	-	-	-	BR8EIX	381507
Niken	850	18-	MR9K-9	512568	-	-
Niken GT	850	19-	MR9K-9	512568	-	-
NR 200	200	-	B7ES	1842	BR7EIX	497115
R 125 SE	125	-	BP7HS	490460	BPR7HIX	497112
Ri-Z 250	250	93-	BR9ES	1890	BR9EIX	381511
RD 125	125	-	B8HS	1837	BR8HIX	381492
RD 125	125	-	B8ES	1843	BR8EIX	381507
RD 125 C, C-DX, D, DX	125	-	B8ES	1843	BR8EIX	381507
RD 125 LC	125	84-	BR8ES	1889	BR8EIX	381507
RD 200	200	-	B7HS	1835	BR7HIX	497113
RD 200	200	-	B7ES	1842	BR7EIX	497115

Modèle	Cylindrée	Année	NGK		Ref CGN iridium
			Bougie	Ref CGN standard	
RD 200 B	200	-	B8HS	1837	381492
RD 200 B	200	-	B7ES	1842	497115
RD 200 C	200	-	B8ES	1843	381507
RD 200 C-DX	200	-	B8ES	1843	381507
RD 200 D	200	-	B8ES	1843	381507
RD 250	250	75-	B8ES	1843	381507
RD 250	250	-	B8HS	1837	381492
RD 250	250	-	B9ES	1844	381511
RD 250	250	-	B8HS	1837	381492
RD 250 D	250	-	B8ES	1843	381507
RD 250 H	250	-	B8ES	1843	381507
RD 250 J	250	-	B8ES	1843	381507
RD 250 LC	250	-	BR8ES	1889	381507
RD 350	350	87-	BR9ES	1890	381511
RD 350	350	-	B8HS	1837	381492
RD 350	350	-	B8ES	1843	381507
RD 350 C	350	-	B8ES	1843	381507
RD 350 H	350	75-	B8ES	1843	381507
RD 350 J	350	-	B8ES	1843	381507
RD 350 LCF	350	86-	BR9ES	1890	381511
RD 400 C	400	-	B8ES	1843	381507
RD 400 D	400	-	B8ES	1843	381507
RD 400 E	400	-	B8ES	1843	381507
RD 400 F	400	-	B9ES	1844	381511
RD F	350	86-	BR9ES	1890	381511
RD N	350	86-	BR9ES	1890	381511
Roadliner S	1854	12-	DPR8EA-9	1857	496388
Royal Star Venture S	1854	12-	DPR8EA-9	1857	496388
RS 125 DX, Z	125	-	B8HS	1837	381492
RS 125 E	125	-	B7HS	1835	497113
RS 125 P	125	-	BP7HS	490460	497112
RS 195	195	-	B7ES	1842	497115
RS 200	200	-	B8ES	1843	381507
RT 180 E	180	93-	B8ES	1843	381507
RX 125	125	-	B8HS	1837	381492
RX 125	125	-	B8ES	1843	381507
RX 125 H	125	-	B7HS	1835	497113
RX 150	150	93-	BP8ES	490461	512589
RX-K	132	07-08	BPR8HS-10	512563	512412
RX-Z	132	07	BR9ES	1890	381511
SCR 950	950	17-	CPR7EA-9	496389	512587
SCR 950	950	17-	CPR7EA-9	496389	512587



Modèle	Cylindrée	Année	NOK		NOK	
			Bougie	Ref CGN standard	Bougie iridium	Ref CGN iridium
SE 250	250	-	BPR7ES	1848	BPR7EIX	512582
SH 185 H	185	-	D7EA	512594	DR7EIX	512413
SR 125	125	-	D8EA	1855	DR8EIX	493825
SR 125	125	96-	DR8EA	198225	DR8EIX	493825
SR 125 SE	125	-95	D8EA	1855	DR8EIX	493825
SR 125 Z	125	93-	DR8EA	198225	DR8EIX	493825
SR 150	150	93-	D8EA	1855	DR8EIX	493825
SR 250	250	-	BPR7ES	1848	BPR7EIX	512582
SR 250	250	07-09	BPR7ES	1848	BPR7EIX	512582
SR 250 F	250	-	BPR7ES	1848	BPR7EIX	512582
SR 250 H	250	-	BPR7ES	1848	BPR7EIX	512582
SR 250 TH	250	-	BPR7ES	1848	BPR7EIX	512582
SR 400	400	-	BPR7ES	1848	BPR7EIX	512582
SR 500	500	95-	BPR7ES	1848	BPR7EIX	512582
SR 500	500	97-	BPR7ES	1848	BPR7EIX	512582
SR 500	500	79-96	BPR7ES	1848	BPR7EIX	512582
SR 500 E	500	-	BPR7ES	1848	BPR7EIX	512582
SR 500 H	500	-	BPR7ES	1848	BPR7EIX	512582
SRX 600	600	-	DPR8EA-9	1857	DPR8EIX-9	496388
SRZ 150	150	07-07	DR8EA	198225	DR8EIX	493825
Star Stratoliner Deluxe	1900	10-	DPR8EA-9	1857	DPR8EIX-9	496388
Stratoliner Deluxe, S	1854	12-	DPR8EA-9	1857	DPR8EIX-9	496388
Stryker Ref. Liquide	1304	12-	LMAR7A-9	512570	-	-
SX-4 Scorpio	223	08-09	DP8EA-9	214029	DPR8EIX-9	496388
SZR 660	660	96-96	DPR9EA-9	1860	DPR9EIX-9	512585
SZR 660	660	97-	DPR8EA-9	1857	DPR8EIX-9	496388
T 125 H, J	125	-	B9EG	1869	-	-
T 135 HC, S, SE, SEC	135	07-09	CPR8EA-9	496384	CPR8EAIX-9	506203
TA 125 A	125	-	B10EG	1870	-	-
TDM 850	850	96-01	DPR9EA-9	1860	DPR9EIX-9	512585
TDM 850	850	97-	DPR8EA-9	1857	DPR8EIX-9	496388
TDM 850	850	97-	DPR8EA-9	1857	DPR8EIX-9	496388
TDM 850 F	850	91-95	DPR8EA-9	1857	DPR8EIX-9	496388
TDM 850 H	850	91-96	DPR9EA-9	1860	DPR9EIX-9	512585
TDM 900	900	02-03	DPR8EA-9	1857	DPR8EIX-9	496388
TDM 900	900	04-04	DPR8EA-9	1857	DPR8EIX-9	496388
TDM 900 A	900	07-09	DPR8EA-9	1857	DPR8EIX-9	496388
TDR 125	125	92-96	BR9ES	1890	BR9EIX	381511
TDR 125	125	97-	BR8ES	1889	BR8EIX	381507
TDR 240	240	-	BR9ES	1890	BR9EIX	381511
T-Max 500	500	04-10	CR7E	213902	CR7EIX	490469
TRD 250	250	-	BR9ES	1890	BR9EIX	381511

MOTEUR

CYCLE

PNEUMATIQUE

ATELIER



ACCESSOIRES

ÉLECTRICITÉ

FILTRATION

FREINAGE

TRANSMISSION

Modèle	Cylindrée	Année	Bougie	 		
				Ref CGN standard	Bougie iridium	Ref CGN iridium
TRX 850	850	95-95	DPR8EA-9	1857	DPR8EIX-9	496388
TRX 850	850	96-96	DPR9EA-9	1860	DPR9EIX-9	512585
TRX 850	850	97-	DPR8EA-9	1857	DPR8EIX-9	496388
TS 650	650	-	B8ES	1843	BR8EIX	381507
TT 225	225	-	DR8ES-L	1859	DR8EIX	493825
TT 250	250	-	D8EA	1855	DR8EIX	493825
TT 250 R	250	94-	CR9E	1863	CR9EIX	381550
TT 250 R	250	07-09	CR9E	1863	CR9EIX	381550
TT 250 RF	250	94-	CR9E	1863	CR9EIX	381550
TT 350 E	350	93-	D8EA	1855	DR8EIX	493825
TT 350 F	350	93-	D8EA	1855	DR8EIX	493825
TT 400 C	400	-	-	-	BR8EIX	381507
TT 500 C	500	-	BPR7ES	1848	BPR7EIX	512582
TT 500 E	500	-	BPR7ES	1848	BPR7EIX	512582
TT 500 H	500	-	BPR7ES	1848	BPR7EIX	512582
TT 600 E	600	93-96	DPR8EA-9	1857	DPR8EIX-9	496388
TT 600 E	600	96-98	DPR8EA-9	1857	DPR8EIX-9	496388
TT 600 R	600	96-98	DPR8EA-9	1857	DPR8EIX-9	496388
TT 600 R	600	98-99	DPR8EA-9	512617	DPR8EIX-9	496388
TT 600 RE	600	03-	DPR8EA-9	1857	DPR8EIX-9	496388
TT 600 S	600	93-	DPR8EA-9	1857	DPR8EIX-9	496388
TT-R 125 EX, LEX	125	08-	CR7HSA	1861	CR7HIX	496398
TT-R 125 LW	125	00-14	CR7HSA	1861	CR7HIX	496398
TT-R 125 LWE	125	03-14	CR7HSA	1861	CR7HIX	496398
TT-R 125 LX	125	08-	CR7HSA	1861	CR7HIX	496398
TT-R 125, E	125	07-09	CR7HSA	1861	CR7HIX	496398
TT-R 230	223	07-09	DR8EA	198225	DR8EIX	493825
TTR 250	250	94-99	CR9E	1863	CR9EIX	381550
TTR 250 R	250	00-	CR9E	1863	CR9EIX	381550
TW 125	125	99-	DR8EA	198225	DR8EIX	493825
TW 200	200	87-	DR8EA	198225	DR8EIX	493825
TW 200 E	200	07-09	DR8EA	198225	DR8EIX	493825
TW 200 E	200	87-	DR8EA	198225	DR8EIX	493825
TW 200 EC	200	87-	DR8EA	198225	DR8EIX	493825
TW 200 F	200	87-	DR8EA	198225	DR8EIX	493825
TW 200 FC	200	94-	D8EA	1855	DR8EIX	493825
TW 200 WI	200	07-	DR8EA	198225	DR8EIX	493825
TW 200 WIC	200	07-	DR8EA	198225	DR8EIX	493825
TW 200 X	200	08-	DR8EA	198225	DR8EIX	493825
TW 225 E	223	07-07	DR8EA	198225	DR8EIX	493825
TY 125	125	-	B7HS	1835	BR7HIX	497113
TY 175 K	175	82-	BPR7ES	1848	BPR7EIX	512582



Modèle	Cylindrée	Année	NOK		NOK	
			Bougie	Ref CGN standard	Bougie iridium	Ref CGN iridium
TY 175, E, J	175	-	B7ES	1842	BR7EIX	497115
TY 250 N	250	-	BR8ES	1889	BR8EIX	381507
TY 250 R	250	-	BR6ES	512536	-	-
TY 250 Z	250	94-	-	-	BPR6EIX	512415
TZ 125	125	80-	-	-	BR10EIX	381617
TZ 125	125	95-	R7376-10	512598	-	-
TZ 125 H	125	-95	-	-	BR10EIX	381617
TZ 125 H	125	95-	R7376-10	512598	-	-
TZ 125, F	125	94-	R7376-10	512598	-	-
TZ 250	250	84-	B10EG	1870	-	-
TZ 250	250	94-	R7282-105	512602	-	-
TZ 250 E	250	93-	R7282-105	512602	-	-
TZ 250 E1	250	93-	R7282-105	512602	-	-
TZ 250 F	250	94-	R7282-105	512602	-	-
TZ 350 B	350	-	B10EG	1870	-	-
TZ 350 H	350	-	B10EG	1870	-	-
TZ 500	500	-	-	-	BR10EIX	381617
TZ 500 H	500	-	-	-	BR10EIX	381617
TZ 750	750	-	B10EG	1870	-	-
TZ 750 D	750	-	-	-	BR10EIX	381617
TZR 125	125	93-	BR9ECM	214181	BR9ECMIX	496382
TZR 250	250	91-95	BR9ECM	214181	BR9ECMIX	496382
TZR 250 A	250	-	BR9ES	1890	BR9EIX	381511
TZR 250 R	250	-	BR9ECM	214181	BR9ECMIX	496382
TZR 250 RS	250	-	BR9ECM	214181	BR9ECMIX	496382
TZR 250 RSP	250	-	BR9ECM	214181	BR9ECMIX	496382
TZR 250 T	250	-	BR9ES	1890	BR9EIX	381511
V 125 Z, ZR	125	07	B8ES	1843	BR8EIX	381507
V Star 250	250	12-	C6HSA	512609	CR6HIX	512424
Vity 125	125	08-	CR7E	213902	CR7EIX	490469
VMX-12 1200 Vmax	1200	85-02	DPR8EA-9	1857	DPR8EIX-9	496388
VMX-17 1700 VMax	1679	09-	CR9EIA-9	496379	-	-
VP 125	125	08	CPR9EA-9	465889	CPR9EAIX-9	512434
VP 125 X-City	125	07	CPR9EA-9	465889	CPR9EAIX-9	512434
VP 250 X-City	250	07-	DPR8EA-9	1857	DPR8EIX-9	496388
VP 300 Varsity	300	03-	DR8EA	198225	DR8EIX	493825
WR 125	125	97-	BR9EG	1892	-	-
WR 125 R, X	125	09-	CR8E	1862	CR8EIX	490470
WR 200 B	200	-	BR9ES	1890	BR9EIX	381511
WR 200 R	200	93-	BR9ES	1890	BR9EIX	381511
WR 200 RE	200	93-	BR9ES	1890	BR9EIX	381511
WR 200 RF	200	93-	BR9ES	1890	BR9EIX	381511

MOTEUR

CYCLE

PNEUMATIQUE

ATELIER



ACCESSOIRES

ÉLECTRICITÉ

FILTRATION



FREINAGE

TRANSMISSION

Modèle	Cylindrée	Année	Bougie	 		
				Ref CGN standard	Bougie iridium	Ref CGN iridium
WR 200 RG	200	-	BR9ES	1890	BR9EIX	381511
WR 200 RH	200	-	BR9ES	1890	BR9EIX	381511
WR 250	250	13-	CR9EK	213936	CR9EIX	381550
WR 250 F	250	01-	CR8E	1862	CR8EIX	490470
WR 250 F	250	03-	CR8E	1862	CR8EIX	490470
WR 250 F	250	07-14	CR9E	1863	CR9EIX	381550
WR 250 F	250	15-	LMAR8G	512565	-	-
WR 250 FX	250	08-	CR8E	1862	CR8EIX	490470
WR 250 R	250	08-	CR9EK	213936	CR9EIX	381550
WR 250 RY	250	09-09	CR9EK	213936	CR9EIX	381550
WR 250 RYC	250	09-09	CR9EK	213936	CR9EIX	381550
WR 250 X	250	08-14	CR9EK	213936	CR9EIX	381550
WR 250 XY	250	09-09	CR9EK	213936	CR9EIX	381550
WR 250 XYC	250	09-09	CR9EK	213936	CR9EIX	381550
WR 250 Z	250	93-	B8EG	198244	-	-
WR 250 ZB	250	-	B8EG	198244	-	-
WR 250 ZE	250	93-	B8EG	198244	-	-
WR 250 ZF	250	93-	B8EG	198244	-	-
WR 250 ZG	250	-	B8EG	198244	-	-
WR 250 ZH	250	-	BR8EG	214162	-	-
WR 400 F	400	98-	CR8E	1862	CR8EIX	490470
WR 426 F	426	00-	CR8E	1862	CR8EIX	490470
WR 450 F	450	03-	CR8E	1862	CR8EIX	490470
WR 450 F	450	07-09	CR8E	1862	CR8EIX	490470
WR 450 F	450	13-	CR8E	1862	CR8EIX	490470
WR 450 FX	450	08-	CR8E	1862	CR8EIX	490470
XA 125	125	08	CR7E	213902	CR7EIX	490469
XC 125	125	90-	CR6HSA	213898	CR6HIX	512424
XC 125 B- /E/ F/ G/ H/ X/ W/ ZW	125	-	C6HSA	512609	CR6HIX	512424
XC 125 Beluga	125	90-95	CR6HSA	213898	CR6HIX	512424
XC 125 S	125	-	CR6HSA	213898	CR6HIX	512424
XC 125 SC	125	-	CR6HSA	213898	CR6HIX	512424
XC 125 T Cygnus	125	98-00	CR7E	213902	CR7EIX	490469
XC 125 T Cygnus- 4KY	125	95-97	CR7E	213902	CR7EIX	490469
XC 125 TR Cygnus	125	96-99	CR7E	213902	CR7EIX	490469
XC 125 TR Cygnus	125	00-	CR7E	213902	CR7EIX	490469
XC 125 X Cygnus X	125	04-	CR7E	213902	CR7EIX	490469
XC 125 ZS	125	-	CR6HSA	213898	CR6HIX	512424
XC 125 ZSC	125	-	CR6HSA	213898	CR6HIX	512424
XC 150 Fly one	150	95-	CR7E	213902	CR7EIX	490469
XG 250	250	07-08	DR7EA	496396	DR7EIX	512413
XG 250 Tricker	250	05-	DR7EA	496396	DR7EIX	512413



Modèle	Cylindrée	Année	NOK		NOK	
			Bougie	Ref CGN standard	Bougie iridium	Ref CGN iridium
XJ 400	400	-	D8EA	1855	DR8EIX	493825
XJ 500	500	-	D8EA	1855	DR8EIX	493825
XJ 550 H	550	-	D8EA	1855	DR8EIX	493825
XJ 550 RH	550	-	D8EA	1855	DR8EIX	493825
XJ 6 N	600	09-	CR9E	1863	CR9EIX	381550
XJ 6 NA	600	09-	CR9E	1863	CR9EIX	381550
XJ 6 S	600	09-	CR9E	1863	CR9EIX	381550
XJ 6 SA	600	09-	CR9E	1863	CR9EIX	381550
XJ 6 SY	600	09-	CR9E	1863	CR9EIX	381550
XJ 600 N	600	92-02	CR8E	1862	CR8EIX	490470
XJ 600 S	600	92-02	CR8E	1862	CR8EIX	490470
XJ 650 H	650	-	BPR7ES	1848	BPR7EIX	512582
XJ 650 LH	650	-	BPR7ES	1848	BPR7EIX	512582
XJ 650 SH	650	-	BPR7ES	1848	BPR7EIX	512582
XJ 650 T	650	82-	BPR8ES	496395	BPR8EIX	512589
XJ 750 Laguna Seca	750	82-	BPR7ES	1848	BPR7EIX	512582
XJ 750 RH	750	-	B7ES	1842	BR7EIX	497115
XJ 900 GT	900	95-	DPR8EA-9	1857	DPR8EIX-9	496388
XJ 900 P	900	07-09	DPR8EA-9	1857	DPR8EIX-9	496388
XJ 900 S	900	95-	DPR8EA-9	1857	DPR8EIX-9	496388
XJ N & S Diversion	600	91-02	CR8E	1862	CR8EIX	490470
XJR 1200	1200	95-98	DPR8EA-9	1857	DPR8EIX-9	496388
XJR 1200 SP	1200	97-98	DPR8EA-9	1857	DPR8EIX-9	496388
XJR 1300	1300	98-	DPR8EA-9	1857	DPR8EIX-9	496388
XJR 1300	1300	07-	DPR8EA-9	1857	DPR8EIX-9	496388
XJR 1300 SP	1300	99-	DPR8EA-9	1857	DPR8EIX-9	496388
XJR 400 R	400	-	CR9E	1863	CR9EIX	381550
X-max 250	250	05-06	DR8EA	198225	DR8EIX	493825
X-max 250	250	07-	DPR8EA-9	1857	DPR8EIX-9	496388
XN 125 Teo's	125	00-	CR8E	1862	CR8EIX	490470
XP 500 T-Max	500	00-11	CR7E	213902	CR7EIX	490469
XP 530 T-Max	500	12-	CR7E	213902	CR7EIX	490469
XQ 125 Maxster, Thunder	125	01-	CR8E	1862	CR8EIX	490470
XS 1100 E	1100	-	BP6ES	490457	BPR6EIX	512415
XS 1100 H	1100	-	BP6ES	490457	BPR6EIX	512415
XS 1100 LH	1100	-	BP6ES	490457	BPR6EIX	512415
XS 1100 RH	1100	-	BP6ES	490457	BPR6EIX	512415
XS 1100 SH	1100	-	BP6ES	490457	BPR6EIX	512415
XS 250 C	250	-	BPR7ES	1848	BPR7EIX	512582
XS 250 H	250	-	BPR7ES	1848	BPR7EIX	512582
XS 250 PK	250	-	D8EA	1855	DR8EIX	493825
XS 250 R	250	-	D8EA	1855	DR8EIX	493825

Modèle	Cylindrée	Année	Bougie	 		
				Ref CGN standard	Bougie iridium	Ref CGN iridium
XS 250 SE	250	-	BPR7ES	1848	BPR7EIX	512582
XS 250 SH	250	-	BPR7ES	1848	BPR7EIX	512582
XS 250 SK	250	-	D8EA	1855	DR8EIX	493825
XS 650	650	-	BPR7ES	1848	BPR7EIX	512582
XS 650 E	650	-	BPR7ES	1848	BPR7EIX	512582
XS 650 H	650	-	BPR7ES	1848	BPR7EIX	512582
XS 650 II	650	-	BPR7ES	1848	BPR7EIX	512582
XS 650 S	650	-	BPR7ES	1848	BPR7EIX	512582
XS 650 SH	650	-	BPR7ES	1848	BPR7EIX	512582
XS 650 Special	650	-	BPR7ES	1848	BPR7EIX	512582
XS 750 C	750	-	B7ES	1842	BR7EIX	497115
XS 750 D	750	-	B7ES	1842	BR7EIX	497115
XS 750 E	750	-	B7ES	1842	BR7EIX	497115
XS 750 S	750	-	B7ES	1842	BR7EIX	497115
XS 750 SE	750	-	B7ES	1842	BR7EIX	497115
XS 750 T	750	-	B7ES	1842	BR7EIX	497115
XSR 700	700	16-	LMAR8A-9	496405	-	-
XSR 900	900	16-	CPR9EA-9	465889	CPR9EAIX-9	512434
XSR 900 Abarth	900	17-	CPR9EA-9	465889	CPR9EAIX-9	512434
XT 1200 Z Super Tenere	1200	10-13	CPR8EB-9	490493	-	-
XT 1200 Z World Crosser	1200	13-	CPR8EB-9	490493	-	-
XT 125	125	-	D8EA	1855	DR8EIX	493825
XT 125 E, EC, F, FC	125	93-	DR8EA	198225	DR8EIX	493825
XT 125 J, K, KC, L	125	-	D8EA	1855	DR8EIX	493825
XT 125 R, X	125	05-	CR7HSA	1861	CR7HIX	496398
XT 225	225	07-07	DR8EA	198225	DR8EIX	493825
XT 225 E	225	93-	DR8EA	198225	DR8EIX	493825
XT 225 EC	225	93-	DR8EA	198225	DR8EIX	493825
XT 225 F	225	93-	DR8EA	198225	DR8EIX	493825
XT 225 FC	225	93-	DR8EA	198225	DR8EIX	493825
XT 250	250	07-09	DR7EA	496396	DR7EIX	512413
XT 250 H	250	83-	DR8EA	198225	DR8EIX	493825
XT 250 X	250	07-08	DR7EA	496396	DR7EIX	512413
XT 350 E	350	93-	D8EA	1855	DR8EIX	493825
XT 350 F	350	93-	D8EA	1855	DR8EIX	493825
XT 400	400	84-	DR7ES	512525	DR7EIX	512413
XT 500 C	500	-	BPR7ES	1848	BPR7EIX	512582
XT 500 E	500	93-	DPR8EA-9	1857	DPR8EIX-9	496388
XT 500 H	500	-	BPR7ES	1848	BPR7EIX	512582
XT 500 T	500	-	DPR8EA-9	1857	DPR8EIX-9	496388
XT 500 Z	500	-	DPR8EA-9	1857	DPR8EIX-9	496388
XT 600	600	86-	DPR8EA-9	1857	DPR8EIX-9	496388



Modèle	Cylindrée	Année	NOK		NOK	
			Bougie	Ref CGN standard	Bougie iridium	Ref CGN iridium
XT 600 E	600	90-	DPR8EA-9	1857	DPR8EIX-9	496388
XT 600 Z Tenere	600	86-	DPR7EA-9	198282	DPR7EIX-9	512580
XT 660 R	660	04-11	CR7E	213902	CR7EIX	490469
XT 660 X	660	04-11	CR7E	213902	CR7EIX	490469
XT 660 Z Ténére	660	08-11	CR7E	213902	CR7EIX	490469
XTR 660	660	04-	CR7E	213902	CR7EIX	490469
XTS 750 SE	750	-	B7ES	1842	BR7EIX	497115
XTZ 125 K	125	07-09	CR7HSA	1861	CR7HIX	496398
XTZ 125 XE, XK	125	08-09	CR7HSA	1861	CR7HIX	496398
XTZ 250	250	07-09	DR8EA	198225	DR8EIX	493825
XTZ 250 X	250	08-09	DR8EA	198225	DR8EIX	493825
XTZ 660	660	94-	DR8EA	198225	DR8EIX	493825
XTZ 660	660	97-	DPR8EA-9	1857	DPR8EIX-9	496388
XTZ 660 Tenere	660	-	DPR8EA-9	1857	DPR8EIX-9	496388
XTZ 750	750	89-	DPR8EA-9	1857	DPR8EIX-9	496388
XTZ 750 Super Tenere	750	-	DPR8EA-9	1857	DPR8EIX-9	496388
XU 1700 Road Star Warrior	1670	03-	DPR7EA-9	198282	DPR7EIX-9	512580
XV 1000	1000	-	BPR7ES	1848	BPR7EIX	512582
XV 1000 F	1000	-	BPR7ES	1848	BPR7EIX	512582
XV 1000 FC	1000	-	BPR7ES	1848	BPR7EIX	512582
XV 1000 SH	1000	-	BPR7ES	1848	BPR7EIX	512582
XV 1100	1100	95-	BPR7ES	1848	BPR7EIX	512582
XV 1100 SC	1100	-	BPR7ES	1848	BPR7EIX	512582
XV 1100 Virago	1100	-98	BPR7ES	1848	BPR7EIX	512582
XV 125	125	97-	CR6HSA	213898	CR6HIX	512424
XV 125 S Virago	125	99-	CR6HSA	213898	CR6HIX	512424
XV 1300 TD	1300	-	DPR8EA-9	1857	DPR8EIX-9	496388
XV 1600 Wild Star	1600	99-04	DPR7EA-9	198282	DPR7EIX-9	512580
XV 1700 PC Road Star	1670	07-09	DPR7EA-9	198282	DPR7EIX-9	512580
XV 1700 Road Star S	1670	12-	DPR7EA-9	198282	DPR7EIX-9	512580
XV 1700 Road Star Silverado S	1670	12-	DPR7EA-9	198282	DPR7EIX-9	512580
XV 1700 Road Star Warrior	1700	08-	DPR7EA-9	198282	DPR7EIX-9	512580
XV 1900	1900	06-	DPR8EA-9	1857	DPR8EIX-9	496388
XV 1900 A Midnight Star	1900	11-16	DPR8EA-9	1857	DPR8EIX-9	496388
XV 1900 Midnight Star	1900	06-10	DPR8EA-9	1857	DPR8EIX-9	496388
XV 1900, S	1854	12-	DPR8EA-9	1857	DPR8EIX-9	496388
XV 240	240	-	CR6HS	512564	CR6HIX	512424
XV 250	250	89-	CR6HS	512564	CR6HIX	512424
XV 250	250	94-	CR6HSA	213898	CR6HIX	512424
XV 250 F	250	94-	C6HSA	512609	CR6HIX	512424
XV 250 S	250	95-	CR6HS	512564	CR6HIX	512424
XV 250 Virago	250	08-	C6HSA	512609	CR6HIX	512424

MOTEUR

CYCLE

PNEUMATIQUE

ATELIER



ACCESSOIRES

ÉLECTRICITÉ

FILTRATION

FREINAGE

TRANSMISSION



Modèle	Cylindrée	Année	Bougie	 		
				Ref CGN standard	Bougie iridium	Ref CGN iridium
XV 250 W	250	-	CR6HSA	213898	CR6HIX	512424
XV 250 WC	250	-	CR6HSA	213898	CR6HIX	512424
XV 400 SE	400	-	BPR7ES	1848	BPR7EIX	512582
XV 500	500	-	BPR7ES	1848	BPR7EIX	512582
XV 535	535	95-96	BPR7ES	1848	BPR7EIX	512582
XV 535	535	97-99	BPR6ES	512566	BPR6EIX	512415
XV 535 DX H Virago	535	00-03	BPR6ES	512566	BPR6EIX	512415
XV 535 DX N Virago	535	00-03	BPR6ES	512566	BPR6EIX	512415
XV 535 DX Virago	535	88-00	BPR7ES	1848	BPR7EIX	512582
XV 535 SH	535	94-	BPR7ES	1848	BPR7EIX	512582
XV 535 SN	535	94-	BPR7ES	1848	BPR7EIX	512582
XV 535 SP	535	94-	BPR7ES	1848	BPR7EIX	512582
XV 600 V Star Classic	600	08-	DPR7EA-9	198282	DPR7EIX-9	512580
XV 750	750	95-	BPR7ES	1848	BPR7EIX	512582
XV 750 F	750	84-	BPR7ES	1848	BPR7EIX	512582
XV 750 FC	750	84-	BPR7ES	1848	BPR7EIX	512582
XV 750 SE	750	-	BPR7ES	1848	BPR7EIX	512582
XV 920 RH	920	-	BPR7ES	1848	BPR7EIX	512582
XV Virago	125	97-	CR6HSA	213898	CR6HIX	512424
XVS 1100 A Classic	1100	99-	BR7ES	455372	BR7EIX	497115
XVS 1100 A Drag Star	1100	02-	BPR7ES	1848	BPR7EIX	512582
XVS 1100 A Drag Star	1100	07-08	BPR7ES	1848	BPR7EIX	512582
XVS 1100 Drag Star	1100	99-01	BPR7ES	1848	BPR7EIX	512582
XVS 1100 Drag Star	1100	02-	BPR7ES	1848	BPR7EIX	512582
XVS 1100 V Custom	1100	08-	BPR7ES	1848	BPR7EIX	512582
XVS 1100 V Star Classic	1100	08-	BPR7ES	1848	BPR7EIX	512582
XVS 1100 V Star Midnight	1100	06-	BPR7ES	1848	BPR7EIX	512582
XVS 125	125	00-	CR7HSA	1861	CR7HIX	496398
XVS 125 DragStar	125	00-	CR7HSA	1861	CR7HIX	496398
XVS 1300 A Midnight Star	1300	07-09	LMAR7A-9	512570	-	-
XVS 1300 A Midnight Star	1300	07-08	LMAR7A-9	512570	-	-
XVS 1300 A Midnight Star	1300	10-	LMAR7A-9	512570	-	-
XVS 1300 AY Midnight Star	1300	09-09	LMAR7A-9	512570	-	-
XVS 250	250	01-	CR6HS	512564	CR6HIX	512424
XVS 250	250	08-08	CR6HSA	213898	CR6HIX	512424
XVS 250 Drag Star	250	01-	CR6HSA	213898	CR6HIX	512424
XVS 250 X	250	08-08	CR6HSA	213898	CR6HIX	512424
XVS 400	400	07-08	DPR7EA-9	198282	DPR7EIX-9	512580
XVS 400 C	400	07-08	DPR7EA-9	198282	DPR7EIX-9	512580
XVS 650	650	97-	DPR7EA-9	198282	DPR7EIX-9	512580
XVS 650 Drag Star	650	97-	DPR7EA-9	198282	DPR7EIX-9	512580
XVS 650 Drag Star	650	07-09	DPR7EA-9	198282	DPR7EIX-9	512580



Modèle	Cylindrée	Année	Bougie			Ref CGN iridium
				Ref CGN standard	Bougie iridium	
XVS 650 Drag Star Classic	650	98-	DPR7EA-9	198282	DPR7EIX-9	512580
XVS 650 V-Star Midnight	650	06-	DPR7EA-9	198282	DPR7EIX-9	512580
XVS 950 A Midnight Star	950	09-15	CPR7EA-9	496389	CPR7EAIX-9	512587
XVZ 1200 TD	1200	-	DPR8EA-9	1857	DPR8EIX-9	496388
XVZ 1300 A Midnigh Star	1300	98-01	DPR7EA-9	198282	DPR7EIX-9	512580
XVZ 1300 A Royal Star	1300	97-	DPR7EA-9	198282	DPR7EIX-9	512580
XVZ 1300 A Royal Star	1300	00-	DPR7EA-9	198282	DPR7EIX-9	512580
XVZ 1300 DE	1300	93-	DPR8EA-9	1857	DPR8EIX-9	496388
XVZ 1300 TF Venture	1300	01-	DPR8EA-9	1857	DPR8EIX-9	496388
XZ 550	550	-	DR8ES-L	1859	DR8EIX	493825
Y 125 E, F	125	-	BR9EG	1892	-	-
YB 125	125	-	B7HS	1835	BR7HIX	497113
YBR 125	125	05-	CR6HSA	213898	CR6HIX	512424
YBR 125 Custom	125	08-	CR6HSA	213898	CR6HIX	512424
YBR 125i	125	07-	CR6HSA	213898	CR6HIX	512424
YBR 250	250	07-13	DR8EA	198225	DR8EIX	493825
YBR 250 P	250	08-08	DR8EA	198225	DR8EIX	493825
YFA1 125 Breeze	125	00-04	CR7HSA	1861	CR7HIX	496398
YJ 125 V Vino	125	06-	CR7E	213902	CR7EIX	490469
YP 125 R Black X-max	125	08-	CPR9EA-9	465889	CPR9EAIX-9	512434
YP 125 R Majesty	125	98-09	CR8E	1862	CR8EIX	490470
YP 125 R X-MAX	125	06-	CPR9EA-9	465889	CPR9EAIX-9	512434
YP 125 RA X-MAX	125	11-	CPR9EA-9	465889	CPR9EAIX-9	512434
YP 250	250	00-	DR8EA	198225	DR8EIX	493825
YP 250 A Majesty	250	00-	DR8EA	198225	DR8EIX	493825
YP 250 Black X-max	250	09-09	DPR8EA-9	1857	DPR8EIX-9	496388
YP 250 Black X-Max	250	10-	DR8EA	198225	DR8EIX	493825
YP 250 DX Majesty	250	99-	DR8EA	198225	DR8EIX	493825
YP 250 Grand Majesty	250	04-	CPR7EA-9	496389	CPR7EAIX-9	512587
YP 250 Majesty	250	-	DR8EA	198225	DR8EIX	493825
YP 250 R Black X-max	250	09-	DPR8EA-9	1857	DPR8EIX-9	496388
YP 250 R X-MAX	250	05-09	DR8EA	198225	DR8EIX	493825
YP 250 R X-MAX	250	10-	CR7E	213902	CR7EIX	490469
YP 400 Majesty	400	04-13	CR7E	213902	CR7EIX	490469
YP 500 T-Max	500	-	CR7E	213902	CR7EIX	490469
YP W Majesty	400	07-	CR7E	213902	CR7EIX	490469
YS 125	125	13-	-	-	BR9EIX	381511
YT 125 L	125	84-	BP6ES	490457	BPR6EIX	512415
YT 125 N	125	85-	BP5ES	490456	BPR5EIX	511478
YT 175 K	175	82-	BPR7ES	1848	BPR7EIX	512582
YTZ 250 N, S	250	85-	B8ES	1843	BR8EIX	381507
YV 535 FC	535	94-	BPR7ES	1848	BPR7EIX	512582

Modèle	Cylindrée	Année	NGK		NGK	
			Bougie	Ref CGN standard	Bougie iridium	Ref CGN iridium
YX 600	600	-	DR8ES-L	1859	DR8EIX	493825
YZ 125	125	80-	B9EG	1869	-	-
YZ 125	125	13-	-	-	BR9EIX	381511
YZ 125 A- / U / W / N / S	125	-	BR9EG	1892	-	-
YZ 125 B- / C / G / G1 / H / X	125	-	B9EG	1869	-	-
YZ 125 E, E1, F, LC	125	-	BR9EG	1892	-	-
YZ 125 SI, T1	125	04-	BR9EG	1892	-	-
YZ 125 WI	125	07-	-	-	BR9EIX	381511
YZ 125 XI	125	08-	-	-	BR9EIX	381511
YZ 175	175	-	-	-	BR10EIX	381617
YZ 250	250	95-	B8EG	198244	-	-
YZ 250 2T	250	13-	BR8EG	214162	-	-
YZ 250 4T	250	13-	CR8E	1862	CR8EIX	490470
YZ 250 F	250	94-	B8EG	198244	-	-
YZ 250 F	250	01-	CR8E	1862	CR8EIX	490470
YZ 250 FE	250	14-	LMAR8G	512565	-	-
YZ 360	360	-	-	-	BR8EIX	381507
YZ 400	400	-	-	-	BR8EIX	381507
YZ 400 C	400	-	-	-	BR8EIX	381507
YZ 400 E	400	-	-	-	BR8EIX	381507
YZ 400 F	400	97-	CR8E	1862	CR8EIX	490470
YZ 426 F	426	99-	CR8E	1862	CR8EIX	490470
YZ 450	450	13-	CR8E	1862	CR8EIX	490470
YZ 450 F	450	03-17	CR8E	1862	CR8EIX	490470
YZ 450 F	450	18-	CPR8EA-9	496384	CPR8EAIX-9	506203
YZ 450 FW	450	07-	CR8E	1862	CR8EIX	490470
YZ 450 FX	450	07-	CR8E	1862	CR8EIX	490470
YZ 465	465	-	B8ES	1843	BR8EIX	381507
YZ 465 H	465	-	B8ES	1843	BR8EIX	381507
YZ 490- K / L / N / S / T / U / W	490	-	BR9EG	1892	BR9EIX	381511
YZ 490- K / L / N / S / T / U / W	490	-	B9EG	1869	-	-
YZF 1000 R	1000	96-02	DR8EA	198225	DR8EIX	493825
YZF 1000 R Thunderace	1000	95-	DR8EA	198225	DR8EIX	493825
YZF 426 F	426	01-	CR8E	1862	CR8EIX	490470
YZF 450	450	04-	CR8E	1862	CR8EIX	490470
YZF 450 F	450	09-	CR8E	1862	CR8EIX	490470
YZF 600 R	600	96-	CR9E	1863	CR9EIX	381550
YZF 600 R Thundercat	600	96-	CR9E	1863	CR9EIX	381550
YZF 600 R6	600	99-	CR10EK	213947	CR10EIX	498279
YZF 600 R6S	600	07-	CR10EK	213947	CR10EIX	498279
YZF 600 R6SW	600	07-	CR10EK	213947	CR10EIX	498279
YZF 600 RW	600	07-	CR9E	1863	CR9EIX	381550



Modèle	Cylindrée	Année	Bougie	 		
				Ref CGN standard	Bougie iridium	Ref CGN iridium
YZF 750 R	750	93-	CR9E	1863	CR9EIX	381550
YZF 750 RF	750	93-	CR9E	1863	CR9EIX	381550
YZF 750 RFC	750	93-	CR9E	1863	CR9EIX	381550
YZF 750 SP	750	93-	CR9E	1863	CR9EIX	381550
YZF 750 SPF	750	93-	CR9E	1863	CR9EIX	381550
YZF-R 125	125	08-13	CR8E	1862	CR8EIX	490470
YZF-R 125	125	14-	CR9E	1863	CR9EIX	381550
YZF-R1	1000	98-01	CR9E	1863	CR9EIX	381550
YZF-R1	1000	02-03	CR9EIA-9	496379	-	-
YZF-R1	1000	04-08	CR9EK	213936	CR9EIX	381550
YZF-R1	1000	09-12	LMAR9E-J	512569	-	-
YZF-R1	1000	13-	LMAR9E-J	512569	-	-
YZF-R1 M	1000	15-	LMAR9E-J	512569	-	-
YZF-R25	250	15-	CR9E	1863	CR9EIX	381550
YZF-R3	320	15-	CR8E	1862	CR8EIX	490470
YZF-R6 600	600	99-02	CR10EK	213947	CR10EIX	498279
YZF-R6 600	600	03-05	CR10EK	213947	CR10EIX	498279
YZF-R6 600	600	06-07	CR10EK	213947	CR10EIX	498279
YZF-R6 600	600	08-11	CR10EK	213947	CR10EIX	498279
YZF-R6 600	600	13-	CR10EK	213947	CR10EIX	498279
YZF-R6 600 CEX	600	08-08	CR10EK	213947	CR10EIX	498279
YZF-R6 600 X	600	08-08	CR10EK	213947	CR10EIX	498279
YZF-R6 600 XC	600	08-08	CR10EK	213947	CR10EIX	498279
YZF-R7	750	99-00	R0373A-10	512567	-	-
YIYING						
YY 125	125	-	CR7HSA	1861	CR7HIX	496398
YY 250	250	-	CR7HSA	1861	CR7HIX	496398
ZNEN						
ZN 125 F Firenze 125	125	-	C7HSA	465600	CR7HIX	496398
ZONGSHEN						
Arktix, Predator ZS125-GY10	125	-	DR8EA	198225	DR8EIX	493825
Explorer	125	-	CR7HSA	1861	CR7HIX	496398
Explorer MRS, MRX	125	-	DP8EA-9	214029	DPR8EIX-9	496388
Explorer Phantom 125	125	-	CR7HSA	1861	CR7HIX	496398
Qingqi 10D GY6 4 Temps	125	08-	CR7HSA	1861	CR7HIX	496398
Qingqi 10D GY6 4 Temps	150	08-	CR7HSA	1861	CR7HIX	496398
Ride MRS, MRX	125	-	DP8EA-9	214029	DPR8EIX-9	496388
Ride Phantom	125	-	CR7HSA	1861	CR7HIX	496398
Storm ZS250GS	250	-	D8EA	1855	DR8EIX	493825

TECHNOLOGIES



SIGNIFICATION DES RÉFÉRENCES

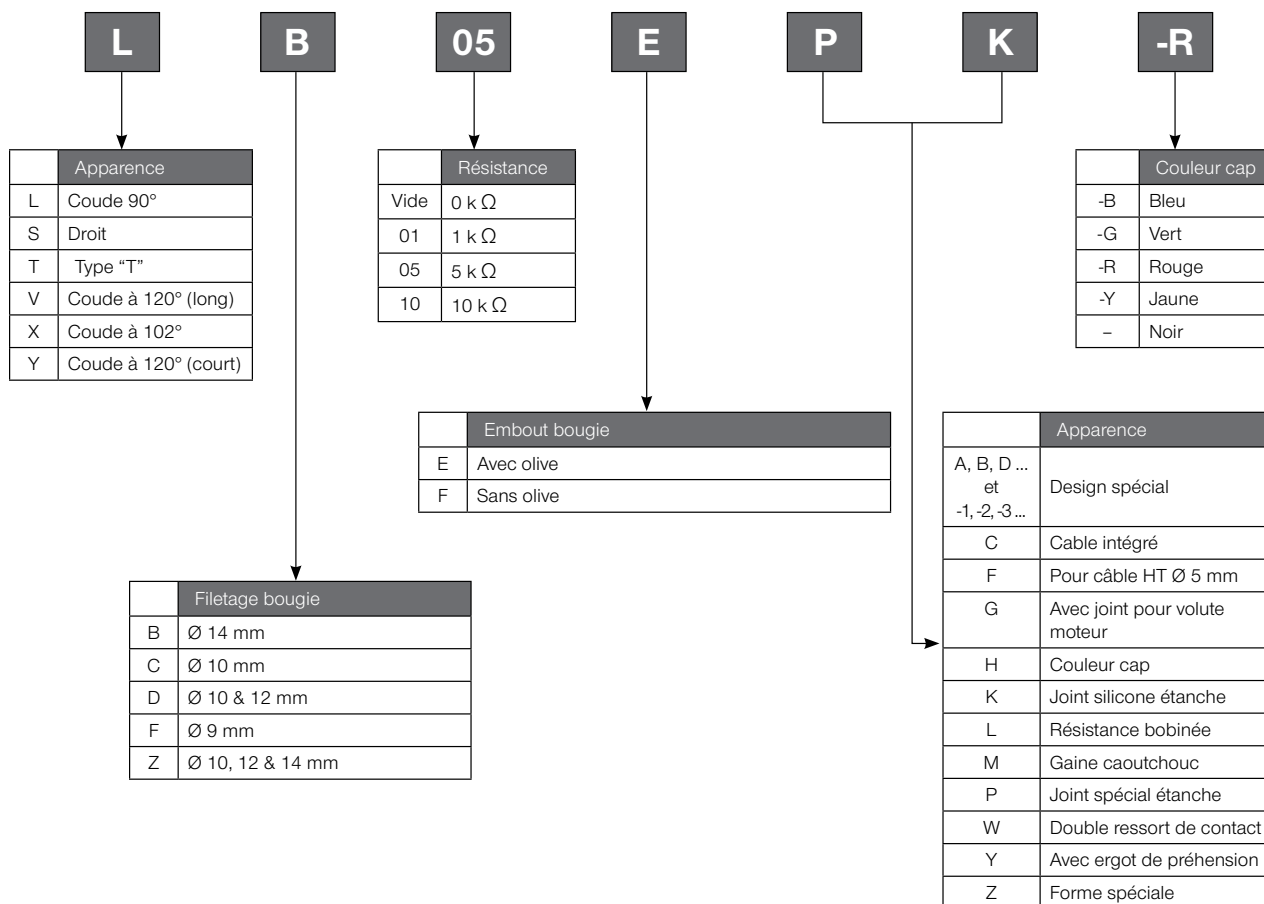



Modèle	Cylindrée	Année	Antiparasite	Référence CGN
APRILIA				
Europa 125, Extrema 125	125	-	LB10F	1803
Mojito Custom 125	125	02 -	LB05E	1802
Pegaso 125	125	-	LB10F	1803
RX 125	125	90 -	LB05F	166637
Scarabeo 125	125	99 - 09	V05E	512579
Scarabeo 125 GT	125	02 - 07	V05E	512579
Scarabeo 125 i.e.	125	09 -	V05E	512579
Sportcity 125	125	-	LB05E	1802
Sportcity One 125	125	08 -	V05E	512579
Leonardo ST	150	02 - 06	LB05E	1802
Mojito 150	150	03 - 06	LB05E	1802
Scarabeo 200	200	00 - 09	V05E	512579
Scarabeo 200 i.e.	200	09 -	V05E	512579
Sportcity Cube 200	200	08 -	V05E	512579
Scarabeo 250	250	04 -	V05E	512579
Scarabeo 300 Special	278	09 -	V05E	512579
Sportcity Cube 300	278	08 -	V05E	512579
Scarabeo 500	500	02 -	V05E	512579
BETA, BETAMOTOR				
EVO 250 4T	250	08 -	VD05EG	512384
EVO 300 4T	300	08 -	VD05EG	512384
BMW				
R 45 [27ch] & [35ch]	475	78 - 85	LB05F	166637
R 50/5	500	-	LB05F	166637
R 60/5, R 60/6, R 60/7	600	- 78	LB05F	166637
R 65	650	78 -	LB05F	166637
R 75/5, R 75/6, R 75/7	750	-	LB05F	166637
R 80, RT, ST	800	82 - 95	LB05F	166637
R 80 R	800	80 -	LB05F	166637
R 80 GS	800	82 - 94	LB05F	166637
R 80/7N, R 80/7S	800	77 - 80	LB05F	166637
R 850 GS	850	98 -	LB05F	166637
R 850 R	850	94 -	LB05F	166637
R 850 RT	850	99 -	LB05F	166637
R 90/6, R 90/S	900	-	LB05F	166637
R 100	1000	-	LB05F	166637
R 100 R	1000	94 -	LB05F	166637
R 100 RS	1000	86 -	LB05F	166637
R 100/7	1000	-	LB05F	166637
R 100, CS, RT	1000	-	LB05F	166637
R 100 RS	1000	- 86	LB05F	166637



Modèle	Cylindrée	Année	Antiparasite	Référence CGN
R 100 GS	1000	86 -	LB05F	166637
R 100 S, T	1000	76 - 80	LB05F	166637
CAGIVA				
WMX 125/84	125	-	LB05F	166637
WMX 125/85	125	-	LB05F	166637
WMX 125/88	125	-	LB05F	166637
Tous modèles	175	-	LB05F	166637
Tous modèles	200	-	LB05F	166637
MX, MXR, RR, RX, WMX	250	-	LB05F	166637
NC, RL, SS, SST	250	83 -	LB05F	166637
RX 250 Rally	250	79 - 83	LB05F	166637
SX, SXT	250	83 - 84	LB05F	166637
Ala Blu 350, Ala Verde 350	350	-	LB05F	166637
Ala Rossa 350/4T	350	83 -	LB05F	166637
Alazzurra 350 (D)	350	84 -	LB05F	166637
Elefant 350(D), Lucky, SST	350	-	LB05F	166637
W12	350	94 -	SD05FP	512391
W16	600	94 -	SB05F	512392
CAN - AM, BOMBARDIER - QUAD				
Renegade X XC 850	850	13 -	VF05EMK	512389
Renegade X XC 1000	1000	13 -	VF05EMK	512389
Renegade X MR 1000	1000	13 -	VF05EMK	512389
CAN - AM, BOMBARDIER - SSV				
Maverick X XC, RS, MR, DS 1000	1000	13 -	VF05EMK	512389
DAELIM				
125 Daystar	125	00 -	XB01F	512394
VC, VS	125	97 -	XB01F	512394
VC 125 Advance	125	95 -	XB01F	512394
VT 125 Evolution	125	98 -	XB01F	512394
DERBI				
GPI 250, GPI Racing	250	07 -	V05E	512579
Rambla 250	250	-	V05E	512579
DUCATI				
600 Pantah SL, Pantah TL (D)	600	81 -	VB05F	490478
900 S, SS, GTS, SD, S2, HR (D)	900	80 - 87	VB05F	490478
GAS GAS				
TT 125	125	-	LB05F CR2	166637 / 279354
TT 200	200	-	LB05F CR2	166637 / 279354
Cross 250, TT 250	250	-	LB05F CR2	166637 / 279354
TT 300	300	-	LB05F CR2	166637 / 279354



Modèle	Cylindrée	Année	Antiparasite	Référence CGN
GILERA				
125 5V Regolarità	125	-	LB05F	166637
125 Arcore, 125 Export	125	72 - 80	LB05F	166637
125 SV Regolarità	125	-	LB05F	166637
Runner ST 200	200	08 -	V05E	512579
Runner 200 VXR	200	-	V05E	512579
Nexus 300	300	09 -	V05E	512579
Fuoco 500	500	07 -	V05E	512579
Nexus 500	500	03 - 04	V05E	512579
Nexus 500	500	05 -	V05E	512579
Saturno 500	500	88 - 92	LB05F	166637
GP 800	840	07 -	VD05EM	512574
HERCULES				
K 125 BW Military	125	74 -	LB05F	166637
K 125 GS	125	-	LB05F	166637
K 125 MC	125	-	LB05F	166637
K 125 S, T	125	72 - 79	LB05F	166637
K 125 X	125	-	LB05F	166637
175 GS	175	-	LB05F	166637
250 GS	250	-	LB05F	166637
350 GS	350	-	LB05F	166637
HONDA				
CB, K, T, Y	125	-	LD05F	512395
CG, CH	125	-	LD05F	512395
CM 125	125	-	LD05FP	512397
CR 125 R	125	-	LB05F CR2	166637 / 279354
Italia 125	125	-	LD05F	512395
Lead 125	125	-	LB05F CR2	166637 / 279354
MBX 125 F	125	-	SD05FM - R	512575
MTX 125, NS 125 F	125	-	LB05EMH - R	512381
MTX 125 R, R2	125	-	LB05F	166637
NS 125 R, NSR 125 F	125	-	LB05F	166637
NS 125 F (Italie)	125	-	LB05EMH - R	512381
TL 125	125	-	VD05F	512396
XL 125, XL 125 S, XR 125	125	-	LD05F	512395
XL 125 R	125	-	VD05FMH	512576
XLR 125 R	125	98 -	VD05FMH	512576
NH 125 D Lead	125	83 -	LB05F	166637
CH 125	125	86 - 95	LD05F	512395
CH 125 P	125	- 93	LD05F	512395
CM 125 C Custum	125	94 -	LD05F	512395
CA 125 Rebel	125	95 -	LD05F	512395



Modèle	Cylindrée	Année	Antiparasite	Référence CGN
Spacy CH 125	125	97 -	LD05F	512395
CA 125 C Rebel	125	97 -	LD05F	512395
CG 125	125	98 -	LD05FP	512397
CLR 125 Cityfly	125	98 -	VD05FMH	512576
CD 185 T	185	-	LD05F	512395
CM 185 T	185	78 -	LD05F	512395
XL 185 S	185	79 -	VD05F	512396
CD 200 T	200	-	LD05F	512395
CM 200 T	200	-	LD05F	512395
XL 200 R	200	83 -	VD05F	512396
MTX 200 RW	200	83 - 85	LB05EMH - R	512381
250 Spacy (Italie)	250	-	LD05F	512395
CN 250 Fusion	250	-	VD05F	512396
250 Spacy	250	-	LD05F	512395
CB 250 T	250	-	LD05F	512395
CBX 250	250	-	SD05FM - R	512575
CD 250 U	250	-	XD05F - R	512398
CH 250	250	-	VD05F	512396
TLR 250	250	-	VD05FMH	512576
VT 250 F2	250	-	SD05FMC	512399
CB 250 N	250	80 -	XD05F - R	512398
CB 250 RS	250	80 -	XD05F - R	512398
CR 250 R	250	- 81	LB05F CR2	166637 / 279354
CM 250 C	250	82 -	LD05FP	512397
CR 250 R	250	82 - 02	LB05F CR2	166637 / 279354
XL 250 R	250	- 83	SD05F - R	512400
XL 250 R	250	84 - 85	SD05F - R	512400
CN 250	250	86 -	VD05F	512396
XL 250 R	250	86 -	SD05F - R	512400
CN 250 Helix	250	87 - 99	VD05F	512396
NX 250 J	250	88 -	VD05F	512396
NX 250 K	250	89 -	VD05F	512396
NX 250 L	250	91 -	VD05F	512396
XR 250 L	250	92 -	SD05F - R	512400
CB 250	250	96 -	XD05F - R	512398
CMX 250 CT	250	96 -	VD05F	512396
CMX 250 C	250	97 -	VD05F	512396
XR 350 R	350	-	VD05F	512396
XL 350 R	350	85 - 87	VD05F	512396
CB 400 T	400	-	YB05F	512577
CBX 400 F, CBX 400 F2	400	-	SD05FMC	512399
CB 400 N	400	78 - 84	XD05F - R	512398



Modèle	Cylindrée	Année	Antiparasite	Référence CGN
CB 400 A	400	79 -	SD05F - R (IN) XD05F - R (OUT)	512400 / 512398
CM 400 T	400	80 - 84	XD05F - R	512398
CB - 1	400	91 -	SD05F - R	512400
CB 450 S, CMX 450 C	450	-	XD05F - R	512398
CB 450 N	450	85 -	LB05F	166637
CB 450 S	450	86 - 88	XD05F - R	512398
XR 500, XR 500 R	500	-	VD05F	512396
XL 500 S	500	79 - 81	VD05F	512396
FT 500	500	82 - 85	VD05F	512396
VT 500 C	500	83 -	VD05F	512396
VT 500 E	500	83 - 85	VD05F	512396
VF 500 F	500	84 -	SD05FMC	512399
VF 500 F2	500	- 84	SD05FMC	512399
VF 500 F2	500	85 -	SD05FMC	512399
XL 500 R	500	- 85	VD05F	512396
XL 500 R	500	86 -	VD05F	512396
GB 500	500	92 -	SD05F - R	512400
CBX 550 F	550	-	SD05FMC	512399
CBX 550 F2	550	-	SD05FMC	512399
CB 550	550	71 - 87	SD05F - R (IN) XD05F - R (OUT)	512400 / 512398
CB 550 F	550	71 - 87	SD05FMC	512399
CB 550 (F1/F2)	550	76 -	SD05F - R (IN) XD05F - R (OUT)	512400 / 512398
CB 550 (K3/K4)	550	76 -	SD05F - R (IN) XD05F - R (OUT)	512400 / 512398
XL 600 L	600	-	SD05FM - R	512575
XL 600 RM	600	-	SD05FM - R	512575
XR 600	600	-	SD05FM - R	512575
XR 600 V	600	-	SD05FM - R	512575
CBX 600 E	600	83 - 87	SD05FM - R	512399
XL 600 R	600	83 - 87	SD05FM - R	512575
XL 600 LM	600	85 - 87	SD05FM - R	512575
XL 600 RM (PD04)	600	86 -	SD05FM - R	512575
XL 600 RM (Italie)	600	-	SD05FM - R	512575
XL 600 V	600	87 -	SD05F - R	512400
XL 600 VN	600	87 -	SD05F - R	512400
XR 600 R	600	87 -	SD05FM - R	512575
XR 600 L	600	87 -	SD05FM - R	512575
CBR 600 F	600	87 - 88	CR1	512578
NTV 600	600	88 - 92	SD05FGA	512401
CBR 600 F	600	89 - 90	CR1	512578
CBR 600 F	600	91 - 94	CR1	512578



Modèle	Cylindrée	Année	Antiparasite	Référence CGN
CBR 600 F2	600	93 - 94	CR1	512578
CBR 600 F3	600	95 - 98	CR1	512578
CB 650 C	650	-	XD05F - R	512398
CB 650 Z	650	-	XD05F - R	512398
FMX 650	650	05 -	SD05F - R	512400
CB 650 SC	650	80 -	XD05F - R	512398
CBX 650 E	650	83 -	SD05FMC	512399
NX 650 Dominator	650	88 -	SD05F - R	512400
NX 650 Dominator	650	88 -	SD05F - R	512400
XRV 650	650	88 - 89	SD05FGA	512401
XRV 750	650	90 - 03	SD05FGA	512401
VT 600	650	92 - 99	SD05FGA	512401
XL 600 Transalp	650	93 - 06	SD05FGA	512401
XL 650 Transalp	650	94 -	SD05F - R	512400
XL 650L	650	94 -	SD05F - R	512400
VT 750	650	97 - 02	SD05FGA	512401
NT 650	650	98 - 04	SD05FGA	512401
NTV 650	650	98 - 04	SD05FGA	512401
CB 750 F2	750	-	SD05F - R	512400
CB 750 FA (Italie)	750	-	SD05F - R	512400
CB 750 Four (Italie)	750	-	SD05F - R	512400
CB 750 FZ	750	-	SD05F - R	512400
CB 750 KZ	750	-	SD05F - R	512400
VFR 750 F (I)	750	-	XD05F - R	512398
VFR 750 FJ (I)	750	-	XD05F - R	512398
CB 750 C	750	80 -	SD05F - R	512400
CB 750	750	82 - 83	SD05F - R	512400
CB 750 K	750	82 - 83	SD05F - R	512400
VF 750 S	750	82 - 83	SD05F - R	512400
VF 750 F	750	83 - 84	CR1	512578
VFR 750 F	750	86 - 87	XD05F - R	512398
VT 750 C	750	87 -	XD05F - R VD05F	512398
VFR 750 F	750	88 - 89	XD05F - R	512398
VFR 750 F	750	90 - 94	XD05F - R	512398
CB 750 F2N, FII	750	91 -	SD05F - R (IN) XD05F - R (OUT)	512400 / 512398
CB 750 F	750	- 91	SD05F - R	512400
CB 750	750	92 -	SD05F - R	512400
NR 750	750	93 -	SD05F - R	512400
RVF	750	94 -	SD05F - R	512400
VFR 750 F	750	94 -	XD05F - R	512398
VF 750 C Magna	750	94 - 95	CR1	512578
VF 750 C	750	95 - 00	SD05F - R	512400



Modèle	Cylindrée	Année	Antiparasite	Référence CGN
VT 750 C	750	97 -	XD05F - R VD05F	512398
VT 750 C2V	750	97 -	XD05F - R VD05F	512398
PC 800 Pacific Coast	800	98 -	SD05F - R	512400
CB 900 F	900	79 -	SD05F - R (IN) XD05F - R (OUT)	512400 / 512398
CB 900 F2	900	79 - 83	SD05F - R (IN) XD05F - R (OUT)	512400 / 512398
CBR 900 RR	900	91 -	XD05F - R	512398
CBR 900 RR	900	96 -	XD05F - R	512398
GL 1000	1000	-	XD05F - R	512398
VF 1000 R	1000	84 - 86	SD05FMC	512399
VF 1000 F2	1000	85 -	SD05FMC	512399
VF 1000 F	1000	- 86	SD05FMC	512399
VF 1000 F	1000	87 -	SD05FMC	512399
CBR 1000 F	1000	87 - 88	SD05F - R (IN) XD05F - R (OUT)	512400 / 512398
CBR 1000 F	1000	89 - 92	SD05F - R (IN) XD05F - R (OUT)	512400 / 512398
CB 1000 F	1000	93 - 00	SD05F - R (IN) XD05F - R (OUT)	512400 / 512398
CBR 1000 F	1000	95 - 00	SD05F - R (IN) XD05F - R (OUT)	512400 / 512398
CBX 1000	1050	-	XD05F - R	512398
CB 1100 F	1100	-	XD05F - R	512398
CB 1100 R	1100	-	SD05F - R (IN) XD05F - R (OUT)	512400 / 512398
GL 1100 R	1100	-	XD05F - R	512398
GL 1100	1100	- 81	XD05F - R	512398
GL 1100 DX	1100	- 81	XD05F - R	512398
GL 1100, DX	1100	82 -	XD05F - R	512398
VF 1100 C	1100	83 -	SD05FMC	512399
GL 1200	1200	84 - 87	XD05F - R	512398
HONDA - QUAD				
ATC 125 M, TRAX 125	125	-	LD05F	512395
TRX 125	125	-	VD05F	512396
ATC 185, ATC 185 S	185	-	LD05F	512395
ATC 200	200	-	VD05F	512396
TRX 200 D	200	92 -	VD05F	512396
ATC 250 ES	250	85 -	VD05F	512396
ATC 250 SX	250	85 -	VD05F	512396
TRX 250, R, X	250	-	VD05F	512396
HUSABERG				
FC 400	400	-	SD05F - R	512400
FE 400 E, S	400	-	SD05F - R	512400



Modèle	Cylindrée	Année	Antiparasite	Référence CGN
FX 400 E	400	-	SD05F - R	512400
FC 501	500	95 -	SD05F - R	512400
FE 501 E, S	500	93 -	SD05F - R	512400
FX 501 E	500	-	SD05F - R	512400
FC 600, E, S	600	92 -	SD05F - R	512400
FX 600 E	600	-	SD05F - R	512400
HUSQVARNA				
SMR 125, SM S4 125	125	11 -	SD05EM	512402
CR 250, WR 250	250	01 -	LB05F CR2	166637 / 279354
SM R 510	510	08 -	SD05EM	512402
TE 410	400	96 - 00	SD05FP	512391
TE 410	400	01 -	SD05FP	512391
SM 570 R	570	01 -	SD05FP	512391
TC 570, TE 570	576	01 -	SD05FP	512391
TE 610 E, TC 610 E, SM 610 E	610	98 -	SD05FP	512391
SM 610	610	07 -	SD05EM	512402
SM S 630	630	10 -	SD05EM	512402
ITALJET				
Dragster 125	125	97 - 97	LB05F	166637
Formula 125	125	97 - 98	LB05F	166637
Formula 125	125	98 -	LB05F	166637
KAWASAKI				
AR 125	125	82 -	LB05F	166637
DX 125, KC 125	125	-	LB05F	166637
KD 125	125	-	LB05E	1802
KDX 125 SR	125	-	LB05F CR2	166637 / 279354
KE 125	125	76 - 83	LB05E	1802
KH 125	125	77 - 81	LB05F	166637
KH 125	125	93 -	LB05F	166637
KMX 125	125	86 -	LB05F	166637
KS 125	125	73 - 76	LB05E	1802
KX 125	125	82 - 84	LB05F	166637
KX 125	125	85 - 90	LB05F	166637
KX 125	125	90 - 91	LB05EMH - R	512381
KX 125	125	91 - 97	LB05EMH - R	512381
KX 125	125	97 -	LB05EMH - R	512381
KD 175	175	-	LB05F	166637
KDX 175	175	80 - 84	LB05EMH - B	512403
KE 175	175	- 80	LB05F	166637
KE 175	175	81 -	LB05F	166637
KE 175 B	175	-	LB05F	166637
KE 175 D	175	-	LB05F	166637



Modèle	Cylindrée	Année	Antiparasite	Référence CGN
KDX 200 H	200	95 -	LB05EMH - R	512381
KDX 200	200	93 - 94	LB05EMH - R	512403
KMX 200	200	88 - 92	LB05F CR2	166637 / 279354
Z 200	200	77 - 79	LB05F	166637
BJ 250 A Estrella	250	93 - 96	LD05F	512395
BJ 250 C Estrella	250	97 -	LD05F	512395
GPZ 250 Belt Drive	250	-	LD05F	512395
GPZ 250 R	250	-	LD05F	512395
KE 250	250	-	LB05E	1802
KH 250	250	73 - 79	LB05E	1802
KL 250 A	250	79 - 83	LB05F	166637
KL 250	250	83 - 91	LD05F	512395
KLX 250	250	80 - 84	LB05E	1802
KLX 250	250	93 -	XD05F - R	512398
KR - 1R, KR - 1S	250	-	LB05F	166637
KT 250	250	-	LB05E	1802
KX 250	250	- 91	LB05F	166637
LTD 250 Belt Drive	250	-	LD05F	512395
LX 250	250	-	LB05F	166637
Z 250	250	-	LB05F	166637
Z 250 A	250	80 -	LD05F	512395
Z 250 B	250	-	LD05F	512395
Z 250 Belt Drive	250	-	LD05F	512395
Z 250 C	250	80 -	LB05F	166637
Z 250 D, G	250	-	LB05F	166637
Z 250 J	250	-	LD05F	512395
Z 250 LTD	250	81 -	LB05F	166637
Z 250 T	250	-	LD05F	512395
ZR 250 (Balius)	250	93 -	SD05F - R	512400
KAF 300 MULE 500 A&B	300	92 - 96	LB05F	166637
GPZ 305 Belt Drive	305	83 -	LD05F	512395
Z 305	305	-	LD05F	512395
EN 400 A	400	-	XD05F - R	512398
GPZ 400, F, F II	400	-	XD05F - R	512398
KH 400	400	-	LB05E	1802
KLE 400	400	93 -	XD05F - R	512398
KX 400	400	-	LB05E	1802
LTD 400	400	-	LD05F	512395
Z 400	400	76 - 81	LB05F	166637
Z 400	400	-	LB05F	166637
Z 400 F	400	83 -	LD05F	512395
Z 400 F - II, J, J(I), K	400	-	LD05F	512395



Modèle	Cylindrée	Année	Antiparasite	Référence CGN
Z 400 LTD	400	-	LB05F	166637
Z 400 M	400	-	LD05F	512395
ZL 400 Eliminator 400SE	400	93 -	LD05F	512395
ZR 400	400	- 83	LD05F	512395
ZR 400	400	84 -	LD05F	512395
ZR 400 - C Zephyr, 400 - D Xanthus	400	93 -	LD05F	512395
ZX 400	400	93 -	LD05F	512395
Z 440	440	80 - 85	LB05F	166637
Z 440 H (Italie)	440	-	LB05F	166637
EN 450 A (Italie)	450	-	XD05F - R	512398
LTD 450	450	85 -	LD05F	512395
EN 500	500	90 -	XD05F - R	512398
EX 500	500	93 -	XB05F	512404
KH 500	500	-	LB05E	1802
KX 500	500	93 -	LBER - B	512403
Z 500	500	-	LD05F	512395
ZR 500	500	-	LD05F	512395
GPZ 550	550	82 - 92	LD05F	512395
LTD 550	550	80 - 85	LD05F	512395
Z 550	550	-	LD05F	512395
ZR 550 B Zephyr	550	91 -	LD05F	512395
ZX 550 A1	550	-	LD05F	512395
ZL 600	600	86 -	XD05F - R	512398
ZL 600 B	600	95 -	XD05F - R	512398
ZX 600 A (Italie)	600	-	LD05F	512395
KLR 650	650	86 - 94	XD05F - R	512398
KLR 650	650	95 -	XD05F - R	512398
KLX 650	650	93 -	SD05FM - R	512575
KLX 650 R	650	93 - 96	SD05FM - R	512575
KLX 650 R	650	98 -	SD05FM - R	512575
Z 650, Z 650 F - B	650	-	LB05F	166637
LTD 700	700	-	LB05F	166637
750 Turbo	750	73 - 86	LB05F	166637
GPX 750 R	750	87 -	SD05F - R	512400
GPX 750 R (I)	750	-	SD05F - R	512400
GPZ 750	750	82 -	LB05F	166637
GPZ 750 R	750	85 -	SD05F - R	512400
LTD 750	750	82 - 87	LB05F	166637
VN 750 Twin	750	-	XD05F - R (IN) LD05F (OUT)	512398 / 512395
VN 750 Vulcan	750	-	XD05F - R (IN) LD05F (OUT)	512398 / 512395
Z 2	750	-	XD05F - R (IN) LD05F (OUT)	512398 / 512395



Modèle	Cylindrée	Année	Antiparasite	Référence CGN
Z 750	750	-	LB05F	166637
ZR 750 C Zephyr	750	91 - 00	LD05FP	512397
ZR 750 D1, D2 Zephyr	750	96 - 00	LD05FP	512397
ZX 750 J	750	-	LB05FP	512393
ZXR 750	750	88 -	XD05F - R	512398
ZXR 750 R	750	90 -	XD05F - R	512398
ZXR 750 R	750	93 -	XD05F - R	512398
GPZ 900 R (Italie)	900	-	XD05F - R (IN) LD05F (OUT)	512398 / 512395
Z 1	900	-	SB05F (IN) YB05F (OUT)	212392 / 512577
Z 900	900	73 - 76	SB05F (IN) YB05F (OUT)	212392 / 512577
KZ 1000 Police	1000	93 -	SB05F (IN) YB05F (OUT)	212392 / 512577
Z 1000	1000	81 -	LB05F	166637
Z 1000	1000	- 80	LB05F	166637
Z 1000 ES, J (Italie)	1000	-	LB05F	166637
ZL 1000	1000	86 -	SD05FM - R	512575
ZX 10	1000	87 - 90	SD05FM - R	512575
GPZ 1100	1100	-	SB05F (IN) YB05F (OUT)	212392 / 512577
GPZ 1100	1100	95 -	SB05F (IN) YB05F (OUT)	212392 / 512577
GPZ 1100 ABS	1100	97 -	SB05F (IN) YB05F (OUT)	212392 / 512577
Z 1100	1100	-	SB05F (IN) YB05F (OUT)	212392 / 512577
Zephyr 1100	1100	96 -	SD05FM - R	512575
ZRX 1100	1100	97 - 00	SD05FM - R	512575
VN - 15 1500 A, B, C, D2, SE	1500	-	XD05F (IN) LD05FP (OUT)	512398 / 512397
KAWASAKI - QUAD				
KLT 160	160	85 -	LD05F	512395
KLF 185	185	85 - 88	LD05F	512395
KLF 220 A	220	88 - 02	LD05F	512395
KLT 200	200	81 - 94	LB05FP	512393
KDX 250	250	91 -	LB05F	166637
KDX 250 SR	250	92 -	LB05F	166637
KLT 250	250	82 - 85	LB05FP	512393
KSF 250	250	87 - 01	XD05F - R	512398
KXF 250	250	88 -	LBER - B	512403
KXT 250	250	84 - 88	LBER - B	512403
KAF 300	300	91 - 97	LB05EMH - R	512381
KEF 300 A, B	300	95 -	LD05F	512395
KLF 300 B, C	300	88 - 06	LB05F	166637



Modèle	Cylindrée	Année	Antiparasite	Référence CGN
KAF 450	450	90 - 96	XD05F - R	512398
KAF 540	540	91 - 93	XB05F - R	512404
KAF 620	620	93 - 01	LB05EMH - R	512381
KTM				
125 EGS	125	98 -	LB05EMH - R	512381
125 Enduro	125	-	LB05F	166637
125 EXC	125	98 -	LB05EMH - R	512381
125 EXE	125	99 -	LB05EMH - R	512381
125 LC 2	125	96 - 00	LB05EMH - R	512381
125 Sting	125	98 -	LB05EMH - R	512381
125 Supermoto	125	99 -	LB05EMH - R	512381
125 SX	125	96 - 00	LB05EMH - R	512381
125 SX	125	02 -	LB05EMH - R	512381
GS 125	125	-	LB05F	166637
MC 125, MC 125 GP	125	-	LB05F	166637
GS 175	175	-	LB05F	166637
MC 175	175	-	LB05F	166637
200 EGS, EXC	200	98 -	LB05EMH - R	512381
200 MXC	200	99 -	LB05EMH - R	512381
200 SX	200	03 -	LB05EMH - R	512381
250 DXC	250	-	LB05EMH - R	512381
250 EGS	250	93 - 95	LB05EMH - R	512381
250 EGS	250	97 -	LB05EMH - R	512381
250 Enduro	250	-	LB05EMH - R	512381
250 EXC Racing GS	250	03 -	VD05EG	512384
250 EXC, EXC Six Days	250	98 - 01	LB05EMH - R	512381
250 EXC	250	96 - 96	LB05EMH - R	512381
250 EXC	250	97 - 98	LB05EMH - R	512381
250 EXC Racing	250	03 -	VD05EG	512384
250 EXC, SX	250	93 - 95	LB05EMH - R	512381
250 EXC Enduro Competition	250	03 -	LB05EMH - R	512381
250 MX	250	-	LB05EMH - R	512381
250 SX	250	96 - 99	LB05EMH - R	512381
250 SX	250	99 -	LB05EMH - R	512381
250 SX	250	05 -	VD05EG	512384
250 SXC	250	99 -	LB05EMH - R	512381
250 SXF	250	05 -	VD05EG	512384
GS 250	250	-	LB05F	166637
MC 250, GP	250	-	LB05F	166637
300 EGS, EXC, EXC Six Days	300	99 -	LB05EMH - R	512381
300 EXC	300	97 - 98	LB05EMH - R	512381
300 EXC Enduro Competition	300	03 -	LB05EMH - R	512381
300 MXC	300	03 -	LB05EMH - R	512381



Modèle	Cylindrée	Année	Antiparasite	Référence CGN
300 SX	300	99 -	LB05EMH - R	512381
360 EXC, MXC, SX	360	97 -	LB05EMH - R	512381
360 SX	360	96 -	LB05EMH - R	512381
380 Enduro, EGS, EXC	380	98 -	LB05EMH - R	512381
380 EGS, SX	380	99 -	LB05EMH - R	512381
400 Enduro - E	400	98 -	SD05F - R	512400
400 EGS, EGS - E	400	97 -	SD05F - R	512400
400 EXC Racing	400	03 -	VD05EG	512384
400 EXC Racing, LC4, LC4 - E	400	99 - 02	VD05F	512396
400 LS - E	400	97 - 02	SD05F - R	512400
400 SC	400	98 -	SD05F - R	512400
400 SC	400	96 -	SD05F - R	512400
400 SX Racing, SX Racing Six Days	400	99 - 02	VD05F	512396
400 SX, SXC	400	98 - 02	SD05F - R	512400
400 SXC	400	99 - 02	SD05F - R	512400
GS 400	400	-	LB05F	166637
LC4 - E 400 Enduro	400	01 -	SD05F - R	512400
LC4 400	400	98 -	SD05F - R	512400
LC4 400 EGS, EXC	400	93 -	SD05F - R	512400
LC4 Competition	400	98 -	SD05F - R	512400
MC 400, MC 400 GP	400	-	LB05F	166637
450 EXC Racing GS, EXC Racing	450	03 -	VD05EG	512384
450 MXC Dessert, MXC GS	450	03 -	VD05EG	512384
450 SMR	450	05 -	VD05EG	512384
450 SX Racing	450	03 -	VD05EG	512384
450 SX - F, SX - F Factory Edition	450	15 -	VF05EGAK	512407
450 XC - F, XC - W	450	15 -	VF05EGAK	512407
GS 500, MC 500 2T	500	-	LB05F	166637
GS 500, MC 500 4T	500	-	LD05F	512395
500 EXC	500	15 -	VF05EGAK	512407
500 XC - W	500	15 -	VF05EGAK	512407
500 EXC	500	16 -	VF05EGAK	512407
500 EXC Six Days	500	16 -	VF05EGAK	512407
500 XC - W	500	16 -	VF05EGAK	512407
520 EXC Racing	520	99 - 02	VD05F	512396
520 EXC Racing Six Days	520	99 - 02	VD05F	512396
520 SX Racing	520	99 - 02	VD05F	512396
525 EXC Racing GS, EXC Racing	525	03 -	VD05EG	512384
525 MXC	525	03 -	VD05EG	512384
525 MXC Desert Racing	525	05 -	VD05EG	512384
525 SMR	525	05 -	VD05EG	512384
525 SX Racing	525	03 -	VD05EG	512384
540 SXC	540	98 -	SD05F - R	512400



Modèle	Cylindrée	Année	Antiparasite	Référence CGN
540 SXC, SXC 20kW	540	99 -	SD05F - R	512400
540 SXS Racing	540	02 -	VD05F	512396
600 Country, Enduro, MX	600	-	LD05F	512395
600 LC4 Enduro 17kW&36kW	600	- 87	LD05F	512395
600 LC4 600 EGS, EXC	600	93 -	LD05F	512395
620 Duke	609	94 -	LD05F	512395
620 LC4 Supercompetition, LC4 SC Supermoto	609	01 - 02	SD05F - R	512400
612 LC4 EGS, EXC	612	93 -	LD05F	512395
620 Duke - E	620	97 -	SD05F - R	512400
620 EGS, EGS - E	620	97 -	SD05F - R	512400
620 LS4 Rallye, LS - E	620	97 -	SD05F - R	512400
620 SC	620	98 -	SD05F - R	512400
620 SC	620	96 -	SD05F - R	512400
620 Supercompetition	620	97 - 02	SD05F - R	512400
620 SX	620	99 -	SD05F - R	512400
620 SX	620	96 -	SD05F - R	512400
620 LC4 EXC, SX	620	94 -	SD05F - R	512400
620 LC4 Super Competition	620	00 - 02	SD05F - R	512400
620 LC4 EGS	620	94 -	SD05F - R	512400
620 Supermoto Competition	620	98 - 00	SD05F - R	512400
625 SC	625	02 -	SD05F - R	512400
625 SMC	625	05 -	VD05EG	512384
625 SXC Hard Enduro	625	03 -	SD05EG	512408
625 SXC Supermoto	625	02 -	SD05F - R	512400
640 Duke	640	98 - 02	SD05F - R	512400
640 Duke II	640	99 - 02	SD05F - R	512400
640 Duke II	640	03 -	SD05EG	512408
640 Duke	640	05 -	VD05EG	512384
640 Supermoto Spezial Edition	640	03 -	SD05EG	512408
640 LC4 Adventure	640	00 - 00	SD05F - R	512400
640 LC4 Adventure	640	01 - 02	SD05F - R	512400
640 LC4 Adventure	640	03 - 03	SD05F - R	512400
640 LC4 Adventure R	640	98 - 01	SD05F - R	512400
640 LC4	640	99 - 01	SD05F - R	512400
640 LC4	640	02 - 02	SD05F - R	512400
640 LC4	640	98 - 00	SD05F - R	512400
640 LC4 Hard Enduro	640	03 -	SD05EG	512408
640 LC4 Supermoto	640	02 - 02	SD05F - R	512400
640 LC4 - E, LC4 - E Supermoto	640	00 - 00	SD05F - R	512400
640 LC4 - E Supermoto	640	01 - 01	SD05F - R	512400
640 LC4 SM	640	05 -	VD05EG	512384
640 LC4 - E Six Days	640	02 - 02	SD05F - R	512400
640 LC4 - E Enduro	640	01 - 01	SD05F - R	512400



Modèle	Cylindrée	Année	Antiparasite	Référence CGN
640 LC4 - E SM Prestige	640	02 - 02	SD05F - R	512400
660 Rallye	650	02 - 02	SD05F - R	512400
660 Super Moto Factory Replica	650	02 -	SD05F - R	512400
660 LC4 Rallye	650	99 - 01	SD05F - R	512400
Rallye	650	00 - 01	SD05F - R	512400
660 SMC	660	05 -	VD05EG	512384
690 Rallye Factory Replica	690	07 -	SF05EGK	512409
690 Supermoto, Supermoto Prestige	690	07 -	SF05EGK	512409
690 Duke, Enduro	690	08 -	SF05EGK	512409
690 Rallye Factory Replica	690	08 -	SF05EGK	512409
690 SMC, Supermoto R	690	08 -	SF05EGK	512409
690 Rallye Factory Replica	690	09 -	SF05EGK	512409
690 Enduro R	690	10 -	SF05EGK	512409
KTM - QUAD				
450 XC	450	10 -	VD05EG	512384
525 XC	525	08 -	VD05EG	512384
KYMCO				
Calypso 125	125	97 -	VD05F	512396
MAICO				
GS 125, MC, SG	125	-	LBER - B	512403
250	250	94 -	LBER - B	512403
GM Star 250, GM Star E 250	250	-	LBER - B	512403
GS 250	250	-	LBER - B	512403
GSE 250	250	-83	LBER - B	512403
MC 250	250	-	LBER - B	512403
320	320	94 -	LBER - B	512403
GS 400	400	74 - 83	LBER - B	512403
MC 400	400	-	LBER - B	512403
440	440	94 -	LBER - B	512403
GSE 490, MC 490	490	- 83	LBER - B	512403
500	500	94 -	LBER - B	512403
GS 500, GS Star, G Star E	500	-	LBER - B	512403
MC 500	500	-	LBER - B	512403
685 Gespann	685	94 -	LBER - B	512403
MBK				
125 12,7 mm	125	-	LB05F	166637
125 19,0mm	125	-	LB05F	166637
250	250	-	LB05F	166637
350	350	73 - 79	LB05F	166637
350 E	350	-	LB05F	166637
350 Injection	350	-	LB05F	166637
MONTESA				
Cota 172, 200	175	-	LB05F	166637



Modèle	Cylindrée	Année	Antiparasite	Référence CGN
Cota 348, 348 Trial	310	-	LB05F	166637
315R	315	97 -	LB05F	166637
Cota 330, 330 Trial	330	-	LB05F	166637
Cota 335, 335E, 349, 349T, 350	350	-	LB05F	166637
Crono 350	350	-	LB05F	166637
Enduro 360 H6, H7, H7S, L	350	-	LB05F	166637
MOTO GUZZI				
250 FD	250	74 - 76	LD05F	512395
250 TS	250	74 - 80	LB05F	166637
V 35 II	350	80 - 87	LB05F	166637
V 35 III	350	85 -	LB05F	166637
V 35 Imola	350	79 - 87	LB05F	166637
V 35 Imola II	350	79 - 86	LB05F	166637
V 65 NTX	650	90 - 92	LB05F	166637
V 65 Polizia NT	650	-	LB05F	166637
V 65 SP	650	- 86	LB05F	166637
850 California	850	75 - 81	LB05F	166637
850 Le Mans II, Le Mans III	850	78 - 81	LB05F	166637
850 T4	850	80 - 83	LB05F	166637
850 T5	850	83 - 87	LB05F	166637
850 TS 5	850	82 - 84	LB05F	166637
1000 SP III	1000	88 - 92	LB05F	166637
California Carb / Inj	1100	94 -	LB10F	1803
California Inj	1100	94 -	LB05F	166637
MZ				
Saxon Roadstar 7kW	125	-	LB05F	166637
Saxon Sportstar 7/11kW	125	-	LB05F	166637
Saxon Roadstar 9kW	150	-	LB05F	166637
Saxon Sportstar 9kW	150	-	LB05F	166637
ETZ Classic 13/15kW	251	-	LB05F	166637
Saxon 251 Fun, Tour - 13/15kW	251	-	LB05F	166637
Kanuni	300	97 -	LB10F	1803
ETZ 301 Classic 17kW	301	-	LB05F	166637
Saxon 301 Fun, Tour - 17kW	301	-	LB05F	166637
MZ (TR)				
TS 125	125	75 - 85	LB05F	166637
PANDA - QUAD				
KD 125 A	125	00 - 01	YB05F	512577
PEUGEOT				
Elystar 125, ABS 125, PBS 125	125	-	RC - X140	497118
Geopolis 125	125	06 -	RC - X140	497118
Looxor 125	125	-	LB05E	1802
Satelis 125, 4V, 4V Avenue	125	04 -	RC - X140	497118



Modèle	Cylindrée	Année	Antiparasite	Référence CGN
Satelis 125 Compressor	125	06 -	RC - X140	497118
Elystar 150	150	03 -	RC - X140	497118
Looxor 150	150	-	LB05E	1802
PGO				
T - REX 125 2T	125	99 -	LB05F	166637
T - REX 125 4T	125	99 -	YB05F	512577
PIAGGIO, VESPA				
125 T5	125	85 -	LB05F	166637
Ape	125	-	LB05F	166637
Beverly 125, Tourer 125	125	02 -	LB05E	1802
Carnaby 125	125	07 -	LB05E	1802
Cosa 125 MA AE	125	88 -	LB05F	166637
Cosa FL 125	125	91 -	LB05F	166637
Cosa 200 FL EBC	125	-	LB05F	166637
Cosa 125	125	-91	LB05F	166637
ET 3 125	125	-	LB05F	166637
ET 4 125	125	-	LB05E	1802
Hexagon LX Ref. Air 2T	125	-	LB05E	1802
Hexagon LX Ref. Liquide 4T	125	-	LB05E	1802
Hexagon LX 125	125	94 -	LB05F	166637
MP3 125 i.e.	125	06 -	L05EA	512410
P 125 ETS	125	83 - 85	LB05F	166637
PK 125 XL 2, XL, E, S	125	-	LB05F	166637
PK 125, 125 Automatic	125	-	LB05F	166637
Primavera 125	125	76 - 83	LB05F	166637
PX 125 E Lusso	125	82 -	LB05F	166637
Sfera 125, RST	125	95 -	LB05F	166637
Skipper 125 LX	125	93 -	LB05F	166637
Skipper 125	125	00 -	LB05E	1802
SKR 125	125	93 -	LB05F	166637
Super Hexagon GTX 125	125	01 -	LB05E	1802
TPH	125	95 -	LB05F	166637
Vespa LX 125	125	05 -	VD05EM	512574
Vespa PX 125 MA AE	125	86 -	LB05F	166637
Vespa T5	125	-	LB05F	166637
Vespa PK 125	125	85 -	LB05F	166637
Vespa PX 125 Kat, XL 125 Plurimat	125	-	LB05F	166637
Vespa T3Li, T3	125	-	LB05F	166637
Vespa 125 T5 Sport	125	-	LB05F	166637
Vespa Gandturistic	125	-04	LB05E	1802
Vespa 125 CL, LS, NK - Primavera	125	-	LB05F	166637
Vespa ET4	125	99 -	VD05EM	512574
Vespa Special ET4 Carburatore	125	-	LB05E	1802



Modèle	Cylindrée	Année	Antiparasite	Référence CGN
Vespa 125 FL2	125	90 -	LB05F	166637
Vespa LX 125 i.e.	125	09 -	LO5EA	512410
Vespa GTS Super 125 i.e.	125	10 -	LO5EA	512410
Vespa GTS 125	125	07 -	LO5EA	512410
Vespa ET4 125	125	96 -	VD05EM	512574
Vespa Special ET3 Primavera	125	-	LB05F	166637
Vespa GT	125	03 -	LB05E	1802
Vespa GTV 125, LXV 125	125	-	LO5EA	512410
Vespa S 125 i.e.	125	08 -	LO5EA	512410
X7 EVO 125 i.e.	125	07 -	V05E	512579
X 8 125	125	04 -	LB05E	1802
X 9 125	125	02 -	LB05E	1802
X EVO	125	06 -	LB05E	1802
Zip 125	125	-	LB05E	1802
EX 150 Hexagon, Hexagon 150	150	94 -	LB05F	166637
Liberty 150	150	02 -	LO5EA	512410
PX 150 E Lusso	150	82 -	LB05F	166637
Skipper 150	150	93 -	LB05F	166637
Skipper ST 4T	150	01 -	LB05E	1802
SKR 150	150	98 -	LB05F	166637
Vespa PX 150 Kat	150	-	LB05F	166637
Vespa PX 150 MA AE	150	86 -	LB05F	166637
Vespa 150 ET4	150	01 - 02	LB05E	1802
Vespa 150 ET4	150	02 -	LB05E	1802
Vespa LX 150 i.e.	150	09 -	LO5EA	512410
Vespa LX 150, S 150 i.e.	150	08 -	LO5EA	512410
Vespa 150 long 12,7 mm Thread	150	-	LB05F	166637
Vespa 150 long 19,0 mm Thread	150	-	LB05F	166637
Vespa 160/ GT	160	-	LB05F	166637
Vespa 175	175	-	LB05F	166637
Super Hexagon LXT 180	180	01 -	LB05E	1802
Vespa SS	180	-	LB05F	166637
X 9 180 Amalfi 4T	180	01 -	LB05E	1802
Ape	190	-	LB05F	166637
Carnaby 200	200	07 -	LB05E	1802
Cosa 200 MA AE	200	88 -	LB05F	166637
Beverly 200	200	01 -	LB05E	1802
Cosa 200 Aluzyl.	200	93 - 97	LB05F	166637
Cosa 2 200	200	88 - 91	LB05F	166637
Cosa FL 200	200	91 -	LB05F	166637
Liberty 200	200	04 -	LB05E	1802
PX 200 E Grand - Sport, 200 E Lusso	200	84 -	LB05F	166637



Modèle	Cylindrée	Année	Antiparasite	Référence CGN
Vespa PX 200E, PX 200E Iris	200	-	LB05F	166637
Vespa PX 200E Iris Elestart	200	-	LB05F	166637
Vespa 200 DN, DS, E	200	-	LB05F	166637
Vespa PX 200 MA AE	200	86 -	LB05F	166637
Vespa 200 TX Elestart	200	-	LB05F	166637
Ape 220	220	-	LB05F	166637
Beverly 250, Cruiser, Tourer	250	03 -	LB05E	1802
Hexagon GT 250 4T	250	98 -	VD05F	512396
MP3 250, RST 250	250	06 -	LB05E	1802
Vespa GTS 250	250	06 -	LB05E	1802
Vespa GTS 250 IE	250	06 -	L05EA	512410
X 7 250	250	07 -	V05EA	512579
X 8 250 i.e.	250	06 -	LB05E	1802
X 9 250 Evolution	250	-	LB05E	1802
X 9 250 EVO	250	07 -	LB05E	1802
Beverly Tourer 300 i.e.	278	10 -	V05EA	512579
Carnaby 300 ie.	278	09 -	L05EA	512410
Vespa GTS 300 Super	278	08 -	L05EA	512410
Vespa GTV 300 via Montenapoleone	278	10 -	L05EA	512410
POLARIS - QUAD				
Big Boss	250	89 - 93	LB05EZ	512411
Cyclone	250	88 - 89	LB05EZ	512411
Scrambler	250	89 - 93	LB05EZ	512411
Trail Blazer	250	90 -	LB05EZ	512411
Trail Boss	250	85 -	LB05EZ	512411
Xplorer 300, Xpress 300	283	94 -	LB05EZ	512411
Sportsman 335	334	99 -	LB05EZ	512411
Big Boss	350	93 -	LB05EZ	512411
Trail Boss	350	90 - 93	LB05EZ	512411
Big Boss 400L 6X6	379	95 - 97	LB05EZ	512411
Scambler 400 4X4	379	94 -	LB05EZ	512411
Sport 400	379	98 -	LB05EZ	512411
Sport ATV	379	95 - 97	LB05EZ	512411
Sportsman 4x4	379	94 - 97	LB05EZ	512411
Xplorer 400 4x4, Xplorer 400L 4x4	379	94 -	LB05EZ	512411
Xplorer 400L 4x4	379	94 -	LB05EZ	512411
Xpress 400 L 2x4	379	96 - 97	LB05EZ	512411
Magnum 2X4, Magnum 4X4	425	95 -	LB05EZ	512411
Magnum 6X6	425	96 - 97	LB05EZ	512411
Big Boss 500 6X6	500	98 -	LB05EZ	512411
Magnum 500, Ranger	500	99 -	LB05EZ	512411
Scrambler 500	500	98 -	LB05EZ	512411
Sportsman 500	500	96 - 04	LB05EZ	512411



Modèle	Cylindrée	Année	Antiparasite	Référence CGN
Xplorer 500	500	97 -	LB05EZ	512411
PUCH				
Lido 125	125	-	LB05F	166637
SACHS				
RS 125, ZX 125	125	97 -	LB05F	166637
SUZUKI				
AN 125	125	95 - 95	LD05F	512395
AN 125	125	96 -	LD05F	512395
CS 125	125	-	LD05F	512395
DR 125 L - N, S	125	91 -	LD05F	512395
DR 125 SE	125	95 -	LD05F	512395
DR 125 SJ	125	-	LD05F	512395
GN 125	125	91 -	LD05F	512395
GN 125 V	125	97 -	LD05F	512395
GP 125	125	-	LB05F	166637
GS 125 S	125	99 -	LD05F	512395
GS 125 S	125	-	LD05F	512395
GT 125, 125 E	125	-	LB05F	166637
RC 125	125	-	LB05F	166637
RG 125	125	85 -	LB05F	166637
RM 125	125	93 - 95	LB05F CR2	166637 / 279354
RM 125	125	96 - 97	LB05F CR2	166637 / 279354
RM 125	125	- 86	LB05F CR2	166637 / 279354
RM 125	125	87 - 92	LB05F CR2	166637 / 279354
TS 125	125	73 - 79	LB05F	166637
TS 125 Construction Code R	125	-	LB05F CR2	166637 / 279354
TS 125 ER	125	79 - 83	LB05F	166637
TS 125 X	125	84 -	LB05F	166637
AN 150 T (Italie)	150	96 -	LD05F	512395
GT 185	185	-	LB05F	166637
TS 185 ER	185	93 -	LB05F	166637
DR 200 SZ	200	95 -	LD05F	512395
GT 200	200	-	LB05F	166637
TS 200	200	-	LB05F CR2	166637 / 279354
DR 250	250	91 -	LD05F	512395
DR 250 S	250	90 -	XD05F - R	512398
DR 250 S	250	-	XD05F - R	512398
DR 250 SZ	250	95 -	XD05F - R	512398
DR 250 SZ - H	250	-	XD05F - R	512398



Modèle	Cylindrée	Année	Antiparasite	Référence CGN
GSX 250 L	250	-	SD05F - R	512400
DR 400 S	400	80 - 83	LD05F	512395
GN 400 TD - X	400	-	LD05F	512395
GS 400 TX	400	-	VB05F	490478
GSF 400 BANDIT	400	- 92	SD05F - R	512400
GSF 400 BANDIT	400	92 -	SD05F - R	512400
GSX 400 E	400	83 -	VB05F	490478
GSX 400 EF, FW, FX, LX, S, SE	400	-	SD05F - R	512400
GSX - R400	400	93 -	SD05F - R	512400
GSX - R400	400	-	SD05F - R	512400
GS 450 E, ES, L, SF, TX	450	-	VB05F	490478
GS 500 E	500	- 00	XB05F (IN) VB05F (OUT)	512404/ 490478
GS 500 E	500	93 - 00	XD05F (IN) VD05F (OUT)	512404 / 512396
GSX 550 EF (Italie)	550	-	SD05F - R	512400
GT 550	550	73 - 77	LB05F	166637
DR 600, R Djebel (Italie), S	600	-	LD05F	512395
GR 650 D, XD, XF	650	-	LD05F	512395
GS 750 D, E, L	750	-	XB05F (IN) VB05F (OUT)	512404/ 490478
GSX 750 E, ES, S, S Katana - (Italie)	750	-	SD05F - R	512400
GSX 750 EF	750	- 85	SD05F - R	512400
GSX R 750	750	- 87	XD05F - R	512398
GSX R 750	750	88 -	XD05F - R	512398
GSX - R 750	750	91 -	XD05F - R	512398
VS 750 GL	750	-	SD05F - R	512400
GS 850 G, GL	850	-	XB05F (IN) VB05F (OUT)	512404/ 490478
GS 1000 D, E, GL, GX, H, S - 1980	1000	-	XB05F (IN) VB05F (OUT)	512404/ 490478
GSX 1100 EFE (Italie), EFG, EG, ESD	1100	-	SD05F - R	512400
GSX 1100 ESG, EZ, S, SZ Katana	1100	-	SD05F - R	512400
GSX 1150 E	1150	- 85	SD05F - R	512400
GSX 1150 E	1150	86 -	SD05F - R	512400
GSX 1150 EF, ES	1150	-	SD05F - R	512400
SUZUKI - QUAD				
LT 160 E	160	- 92	LD05F	512395
LT 160 E, F	160	93 -	LD05F	512395
LT - F 160	160	95 -	LD05F	512395
LT 230 E	230	93 -	LD05F	512395
LT 230 E, F, GE	230	-	LD05F	512395
LT - F 250	250	88 - 99	VD05F - R	512396
LT 250	250	88 - 93	VD05F - R	512396
LT 250	250	85 - 86	XD05F - R	512398



Modèle	Cylindrée	Année	Antiparasite	Référence CGN
LT 250 R	250	85 - 92	XD05F - R	512398
LT 250 S	250	89 - - 90	VD05F - R	512396
LT - F 250	250	88 - 00	VD05F - R	512396
LT - F 250 F	250	99 - 00	VD05F - R	512396
LT - F 250 4WD	250	87 - 98	VD05F - R	512396
LT - F 250 4WDX	250	91 - 98	VD05F - R	512396
LT 300	300	87 - 89	XD05F - R	512398
LT - F 300 F	300	99 - 00	VD05F - R	512396
LT - A 500 F	500	98 - 00	VD05F - R	512396
LT 500	500	87 - 90	LB10EH	1804
YAMAHA				
BL 125	125	85 - 89	LB05F	166637
DT 125	125	94 -	LB05F	166637
DT 125 E	125	73 - 76	LB05F	166637
DT 125 E	125	77 - 79	LB05F	166637
DT 125 E, F, H	125	-	LB05F	166637
DT 125 LC	125	82 - 85	LB05F	166637
DT 125 LC	125	86 -	LB05F	166637
DT 125 MX	125	-	LB05F	166637
DT 125 R, RE	125	91 -	LB05F CR2	166637 / 279354
DT 125 Tenere (Italie)	125	-	LB05F	166637
IT 125, H, MX 125	125	-	LB05F	166637
R 125 SE	125	-	LB05F	166637
RD 125 12,7 & 19,0 mm	125	-	LB05F	166637
RD 125 C, C - DX, D	125	-	LB05F	166637
RD 125 D - DX	125	73 - 75	LB05F	166637
RD 125 LC	125	82 - 83	LB05F	166637
RD 125 LC	125	84 -	LB05F	166637
RS 125 DX, E, P, Z	125	-	LB05F	166637
RX 125 12,7 & 19,0 mm	125	-	LB05F	166637
RX 125 H	125	-	LB05F	166637
SR 125	125	-	LD05F	512395
SR 125 10F	125	97 -	LD05F	512395
SR 125 Z	125	93 -	LD05F	512395
TA 125	125	73 - 75	LB05F	166637
TA 125 A	125	-	LB05F	166637
TDR 125	125	92 -	LB05F	166637
TDR 125	125	97 -	LB05F	166637
TY 125	125	77 - 81	LB05F	166637
TZ 125	125	80 -	LB05F	166637
TZ 125	125	95 -	LB05F	166637
TZ 125, F	125	94 -	LB05F	166637



Modèle	Cylindrée	Année	Antiparasite	Référence CGN
TZ 125 H	125	-	LB05F	166637
TZR 125	125	- 92	LB05F CR2	166637 / 279354
TZR 125	125	93 -	LB05E	1802
XC 125	125	90 -	LD05F	512395
XC 125 Cygnus, T	125	95 -	LD05F	512395
XC 125 Cygnus	125	- 94	LD05F	512395
XC 125 T	125	94 -	LD05F	512395
XC 125 T Cygnus T, TR Cygnus	125	96 -	LD05F	512395
XT 125	125	-	LD05F	512395
XV 125	125	97 -	LD05F	512395
YB, YZ	125	-	LB05F CR2	166637 / 279354
YS 125	125	-	LB05F	166637
YZ 125 B, C	125	-	LB05F	166637
YZ 125 E, EI, F	125	93 -	LB05F	166637
YZ 125 H, X	125	-	LB05F	166637
FZ 150, FZR 150	150	94 -	LD05F	512395
RX 150, SR 150	150	93 -	LB05F	166637
XC 150 Fly one (Italie)	150	95 -	LD05F	512395
DT 165 R	165	91 -	LB05F	166637
AG 175, H	175	-	LB05F	166637
DT 175	175	74 - 75	LB05F	166637
DT 175 E, F, H	175	-	LB05F	166637
DT 175 MX	175	78 - 81	LB05F	166637
IT 175	175	83 - 84	LB05F	166637
IT 175 E, H, MX 175, B, H	175	-	LB05F	166637
TY 175, E, J, YZ 175	175	-	LB05F	166637
RT 180 E	180	93 -	LB05F	166637
XC 180	180	83 - 84	LD05F	512395
SH 185 H	185	-	LD05F	512395
RS 195	195	-	LB05F	166637
AG 200 E, F	200	93 -	LD05F	512395
BW 200	200	-	LD05F	512395
DT 200 LC, RE, RF	200	93 -	LB05F	166637
DT 200 R	200	-	LB05F CR2	166637 / 279354
IT 200 S, NR 200	200	-	LB05F	166637
RD 200 12,7&19,0 mm	200	-	LB05F	166637
RD 200 C, C - DX, D	200	-	LB05F	166637
RD 200 D - DX	200	77 - 80	LB05F	166637
RS 200	200	-	LB05F	166637
TW 200	200	87 -	LD05F	512395
TW 200 E, EC, F	200	93 -	LD05F	512395



Modèle	Cylindrée	Année	Antiparasite	Référence CGN
TW 200 FC	200	94 -	LD05F	512395
WR 200 R, RE, RF	200	93 -	LB05F	166637
XT 225 E, EC, F, FC	225	93 -	LD05F	512395
TDR 240	240	-	LB05F	166637
XV 240	240	-	LD05F	512395
DT 250	250	75 - 76	LB05F	166637
DT 250 E, H	250	-	LB05F	166637
DT 250 MX	250	77 - 81	LB05F	166637
IT 250	250	81 -	LB05F	166637
IT 250	250	85 -	LB05F	166637
IT 250 J, K, N	250	-	LB05F	166637
MX 250	250	-	LB05F	166637
RI - Z	250	93 -	L05F CR2	166637 / 279354
RD 250	250	75 -	LB05F	166637
RD 250 D	250	-	LB05F	166637
RD 250 LC	250	80 - 83	LB05F	166637
SE 250 (Italie)	250	-	LB05F	166637
SR 250, F, H	250	-	LB05F	166637
SR 250 SE	250	80 - 82	LB05F	166637
SR 250 TH	250	-	LB05F	166637
TDR 250 (Italie)	250	88 - 89	LB05F	166637
TRD 250, TT 250	250	-	LB05F	166637
TT 250 R, RF	250	94 -	LB05F CR2	166637 / 279354
TY 250	250	75 - 79	LB05F	166637
TY 250	250	84 - 87	LB05F	166637
TY 250	250	88 - 90	LB05F	166637
TY 250 Z	250	94 - 96	LB05F	166637
TZ 250	250	- 83	LB05F	166637
TZ 250	250	84 -	LB05F	166637
TZ 250	250	95 -	LB05F	166637
TZ 250	250	94 -	LB05F	166637
TZ 250 E	250	- 83	LB05F	166637
TZ 250 E, EI	250	93 -	LB05F	166637
TZ 250 F	250	94 -	LB05F	166637
TZ 250 H	250	- 83	LB05F	166637
TZR 250	250	87 - 89	LB05F	166637
WR 250 Z, ZE, ZF	250	93 -	LB05E	1802
XS 250	250	78 - 79	LB05F	166637
XS 250 C, H	250	-	LB05F	166637
XS 250 RH	250	- 83	LB05F	166637
XS 250 SE, SH	250	-	SD05F - R	512400
XT 250	250	80 - 82	SD05F - R	512400



Modèle	Cylindrée	Année	Antiparasite	Référence CGN
XT 250 H	250	- 84	LB05F	166637
XV 250	250	89 -	LD05F	512395
XV 250, F	250	94 -	LD05F	512395
XV 250 S	250	95 -	LD05F	512395
YP 250 Majesty	250	-	LD05F	512395
YZ 250	250	82 - 83	LB05F	166637
YZ 250	250	84 - 87	LB05F	166637
YZ 250	250	88 - 91	LB05F	166637
YZ 250	250	92 -	LB05F	166637
YZ 250	250	95 -	LB05F	166637
YZ 250 F	250	94 -	LB05F	166637
BW 350	350	-	LD05F	512395
TZ 350 B, H	350	-	LB05F	166637
XT 350	350	85 - 90	LD05F	512395
XT 350	350	91 -	LD05F	512395
XT 350 E, F	350	93 -	LD05F	512395
DT 360	360	73 - 75	LB05F	166637
MX 360, YZ 360	360	-	LB05F	166637
DT 400	400	75 - 76	LB05F	166637
DT 400 E, H	400	-	LB05F	166637
DT 400 MX	400	77 - 80	LB05F	166637
FZR 400	400	87 -	SD05F - R	512400
IT 400, E, MX 400	400	-	LB05F	166637
RD 400	400	76 - 79	LB05F	166637
RD 400 E, TT 400 C	400	-	LB05F	166637
SR 400	400	-	LB05F CR2	166637 / 279354
XJ 400	400	-	XD05F - R	512398
XT 400	400	84 -	LD05F	512395
XV 400 SE	400	-	XB05F	512404
YZ 400, C, E	400	-	LB05F	166637
IT 425	425	-	LB05E	1802
IT 465	465	81 -	LB05E	1802
IT 465 H	465	-	LB05E	1802
YZ 465, H	465	-	LB05E	1802
IT 490	490	83 - 85	LB05F	166637
YZ 490	490	-	LB05F	166637
IT 500	500	-	LB05F	166637
RD 500 LC	500	- 86	LB05F	166637
SR 500 2J4,48T	500	79 - 96	LB05F CR2	166637 / 279354
SR 500 3EB	500	95 -	LB05F CR2	166637 / 279354

MOTEUR

CYCLE

PNEUMATIQUE

ATELIER

ACCESSOIRES

ÉLECTRICITÉ

FILTRATION

FREINAGE

TRANSMISSION



Modèle	Cylindrée	Année	Antiparasite	Référence CGN
SR 500 48T	500	97 -	LB05F CR2	166637 / 279354
SR 500 E, H	500	-	LB05F CR2	166637 / 279354
XJ 500	500	-	XD05F - R	512398
XT 500	500	76 - 89	LB05F	166637
XT 500 C	500	-	LB05F	166637
XT 500 E	500	- 92	LB05F	166637
XT 500 H	500	-	LB05F	166637
XV 500 (Italie)	500	-	XB05F	512404
XV 500 SE	500	83 - 87	XB05F	512404
XT 550	550	82 - 83	LD05F	512395
XZ 550	550	82 - 84	LD05F	512395
XZ 550 S	550	83 - 84	LD05F	512395
SRX 600	600	86 - 89	SD05F - R	512400
XT 600	600	84 - 87	XD05F - R	512398
XT 600	600	87 - 90	XD05F - R	512398
XT 600 E	600	95 -	LD05F	512395
XT 600 E	600	90 - 94	LD05F	512395
XT 600 E, EF, EFC	600	94 -	LD05F	512395
XT 600 EH	600	97 -	LD05F	512395
XT 600 K	600	90 - 94	LD05F	512395
XJ 650	650	80 - 83	XB05F	512404
XJ 650 H, LH, SH	650	-	XB05F	512404
XJ 650 T Turbo	650	82 -	XB05F	512404
XS 650 (Italie)	650	76 - 83	XB05F	512404
XS 650 E, H, II, S, SH	650	-	XB05F	512404
XS 650 SE	650	79 - 81	XB05F	512404
FZ 750	750	85 - 86	SD05F - R	512400
FZ 750	750	91 -	SD05F - R	512400
FZ 750 Genesis	750	87 - 90	SD05F - R	512400
TZ 750, D	750	-	LB05F	166637
XJ 750	750	- 83	LB05F CR2	166637 / 279354
XJ 750	750	84 - 85	LB05F CR2	166637 / 279354
XJ 750 RH	750	-	LB05F CR2	166637 / 279354
XS 750	750	77 - 79	XB05F	512404
XS 750 C, D, E, S, SE, T	750	-	XB05F	512404
XTS 750 SE	750	-	XB05F	512404
XV 750	750	- 83	XB05F	512404
XV 750	750	95 -	XB05F	512404
XS 850	850	80 - 81	XB05F	512404
XS 850 H	850	-	XB05F	512404



Modèle	Cylindrée	Année	Antiparasite	Référence CGN
XS 850 LH, SH	850	-	XB05F	512404
XJ 900	900	83 - 84	XB05F	512404
XJ 900	900	85 - 90	XB05F	512404
XJ 900	900	91 -	XB05F	512404
FJ 1100	1100	84 - 85	SD05F - R	512400
XS 1100	1100	78 - 82	XB05F	512404
XS 1100 E, H, LH, RH	1100	-	XB05F	512404
XS 1100 S	1100	81 - 82	XB05F	512404
XS 1100 SH	1100	-	XB05F	512404
XV 1100	1100	95 -	XB05F	512404
XV 1100 SC	1100	-	XB05F	512404
FJ 1200	1200	86 - 87	SD05F - R	512400
FJ 1200	1200	88 - 90	SD05F - R	512400
FJ 1200	1200	91 -	SD05F - R	512400
FJ 1200 AE, AEC, E, F	1200	93 -	SD05F - R	512400
XVZ 1200 TD	1200	84 - 87	XD05F - R	512398
Golf Car G2A	-	92 -	LB05F	166637
Golf Car G9A	-	92 -	LB05F	166637
YAMAHA - QUAD				
YFA 1 Breeze	125	89 - 04	LD05F	512395
YFA 1 F	125	94 -	LD05F	512395
YT 125, CH, H	125	-	LB05F	166637
YT 175	175	-	LB05F	166637
YFM 200	200	92 -	LD05F	512395
YFM 200	200	85 - 86	LD05F	512395
YFM 225 2HT, 59V	200	-	LD05F	512395
YFS 200 Blaster	200	90 - 04	LB05F	166637
YFS 200 E, F	200	93 -	LB05F	166637
TT 225	225	-	LD05F	512395
YFM 225	225	92 -	LD05F	512395
YFB 250	250	93 -	LD05F	512395
YFB 250 E, F, FWF	250	93 -	LD05F	512395
YFB 250, FW	250	94 -	LD05F	512395
YFM 250 Timberwolf	250	-	LD05F	512395
YFM 250	250	90 -	LD05F	512395
YFB 350	350	96 - 97	LD05F	512395
YFM - F 350, YFM - X 350	350	87 - 97	LD05F	512395
YFU - 1	350	89 -	LD05F	512395
YFZ 350	350	87 - 97	LB05E	1802
YFM 400	400	93 - 97	LD05F	512395

MOTEUR

CYCLE

PNEUMATIQUE

ATELIER

ACCESSOIRES

ÉLECTRICITÉ

FILTRATION

FREINAGE

TRANSMISSION





HIFLOFILTRO

PREMIUM FILTERS



GAMME DE PRODUITS /

Filtres à huile OEM

Hiflofiltro est le premier et le seul filtre à huile pour moto au monde approuvé par le TÜV. Fabriqués avec les meilleurs matériaux disponibles, tous les filtres à huile Hiflofiltro sont testés et certifiés pour atteindre ou dépasser les niveaux de performance des équipements d'origine.



FILTRES À HUILE HAUTE PERFORMANCE « RC » /

Filtration ultime pour la piste et la rue

Développée et fabriquée selon des spécifications très élevées pour dépasser les exigences des moteurs de course modernes et des conditions de course extrêmes, la gamme Hiflofiltro RC offre de nombreux avantages à la fois aux utilisateurs de route et aux coureurs sur piste.

- Écrou cruciforme de 17 mm permettant une installation, un retrait et un verrouillage faciles.
- Média de filtration tri-fibres haute performance avancé pour une filtration optimale, une capacité élevée et un débit d'huile amélioré. Capable de capturer des particules aussi petites que 5 microns
- Bidon en acier robuste capable de résister à une pression extrême
- Soupape de décharge spéciale recouverte de fibre ou de caoutchouc pour une étanchéité parfaite
- Compatible avec tous les types d'huiles, minérales et synthétiques



FILTRES À AIR OEM /

Les filtres à air Hiflofiltro sont fabriqués selon des normes très élevées pour remplacer directement les filtres d'origine. Média filtrant Hiflo de la meilleure qualité, spécialement développé pour protéger les moteurs japonais modernes de haute performance. Pour les modèles BMW et autres motos européennes de grande capacité, Hiflofiltro utilise exclusivement des médias filtrants fabriqués en Allemagne, pour une parfaite compatibilité OE, une protection supérieure du moteur et des performances optimales.



FILTRES À AIR EN MOUSSE À DEUX ÉTAGES /

Pour motocross, enduro, quad et scooter

Construit à partir de deux couches de mousse à pores ouverts pour fournir une excellente circulation de l'air et une filtration maximale. La couche extérieure retient les plus grosses particules de saleté et d'eau, gardant la fine couche intérieure libre pour piéger les fines particules de poussière. Les filtres en mousse Hiflofiltro à deux étages sont conçus pour être nettoyés et réutilisés maintes et maintes fois. Les deux couches de mousse sont laminées ensemble pour fournir une liaison durable et permanente. Le filtre est construit à partir de morceaux de mousse double couche collés ensemble à l'aide d'un adhésif spécialement formé qui n'est pas affecté par les cycles répétés de nettoyage et d'huilage. Développé et fabriqué aux Pays-Bas.



Modèle	Cylindrée	Année	H.FLOFILTRO		H.FLOFILTRO	
			Filtre huile Réf. HilfoFiltro	Filtre huile Réf. CGN	Filtre air Réf. HilfoFiltro	Filtre air Réf. CGN
ADIVA						
125/150 AD (BENELLI ADIVA)	125	01 - 06	HF183	494342	HFA5209	502281
APRILIA						
125 ATLANTIC	125	02 - 14	HF183	494342	HFA5201	527098
125 LEONARDO / ST	125	96 - 05	HF185	478083	HFA6111	513390
125 RS4	125	11 - 17	HF563	502307	HFA6112	527097
125 RS 4T	125	17 - 18	HF563	502307	HFA6112	527097
125 RS REPLICIA 4T	125	17 - 20	HF563	502307	HFA6112	527097
125 RX 4T	125	18 - 20	HF563	502307	HFA6112	527097
125 SCARABEO (ROTAX ENGINE)	125	99 - 03	HF185	478083	HFA6104	513382
125 SCARABEO (PIAGGIO ENGINE)	125	03 - 05	HF183	494342	HFA6104	513382
125 SCARABEO GT (ROTAX ENGINE)	125	02 - 03	HF185	478083	HFA6104	513382
125 SCARABEO GT/STREET (PIAGGIO ENGINE)	125	03 - 07	HF183	494342	HFA6104	513382
125 SPORT CITY	125	04 - 09	HF183	494342	HFA5201	527098
125 SPORT CITY ONE	125	08 - 13	HF183	494342	HFA5202	513359
125 SPORT CITY CUBE	125	08 - 13	HF183	494342	HFA5201	527098
125 SPORT CITY STREET	125	12 - 14	HF183	494342	HFA5201	527098
125 SR MAX 4T	125	11 - 15	HF183	494342	HFA5201	527098
125 SR MOTARD 4T	125	12 - 16	HF183	494342	HFA5202	513359
125 SX 4T	125	19 - 20	HF563	502307	HFA6112	527097
125 TUONO 4T	125	17 - 20	HF563	502307	HFA6112	527097
150 LEONARDO / ST	150	96 - 05	HF185	478083	HFA6111	513390
200 ATLANTIC	200	03 - 08	HF183	494342	HFA5201	527098
200 SCARABEO (ROTAX ENGINE)	200	99 - 03	HF185	478083	HFA6104	513382
200 SCARABEO (PIAGGIO ENGINE)	200	03 - 05	HF183	494342	HFA6104	513382
200 SCARABEO GT (ROTAX ENGINE)	200	99 - 03	HF185	478083	HFA6104	513382
200 SCARABEO GT/STREET (PIAGGIO ENGINE)	200	03 - 07	HF183	494342	HFA6104	513382
200 SPORT CITY	200	04 - 09	HF183	494342	HFA5201	527098
200 SPORT CITY CUBE	200	08 - 13	HF183	494342	HFA5201	527098
250 ATLANTIC	250	04 - 06	HF183	494342	HFA5201	527098
250 ATLANTIC I.E.	250	06 - 09	HF183	494342	HFA5201	527098
250 SCARABEO (PIAGGIO ENGINE)	250	03 - 05	HF183	494342	HFA6104	513382
250 SCARABEO GT (PIAGGIO ENGINE)	250	04 - 06	HF183	494342	HFA6104	513382
250 SCARABEO I.E. / LIGHT	250	06 - 11	HF183	494342	HFA5201	527098
250 SPORT CITY I.E.	250	06 - 09	HF183	494342	HFA5201	527098
250 SPORT CITY CUBE I.E.	250	08 - 13	HF183	494342	HFA5201	527098
300 ATLANTIC I.E.	300	10 - 14	HF183	494342	HFA5201	527098
300 SCARABEO LIGHT / SPECIAL	300	09 - 13	HF183	494342	HFA5201	527098
300 SPORT CITY CUBE I.E. / STREET	300	08 - 14	HF183	494342	HFA5201	527098
300 SR MAX	300	11 - 15	HF183	494342	HFA5201	527098
400 ATLANTIC SPRINT	400	06 - 09	HF184	478088	HFA5201	527098
400 SCARABEO / LIGHT	400	06 - 09	HF184	478088	HFA5201	527098
450 RXV ENDURO	450	06 - 15	HF563	502307	HFA6101	513380
450 SXV SUPER MOTO	450	06 - 15	HF563	502307	HFA6101	513380

MOTEUR

CYCLE

PNEUMATIQUE

ATELIER

ACCESSOIRES

ÉLECTRICITÉ

FILTRATION

FREINAGE

TRANSMISSION

Modèle	Cylindrée	Année	HIFLOFILTRO		HIFLOFILTRO	
			Filtre huile Réf. HifloFiltro	Filtre huile Réf. CGN	Filtre air Réf. HifloFiltro	Filtre air Réf. CGN
450 SXV STREET LEGAL	450	9	HF563	502307	HFA6101	513380
500 ATLANTIC SPRINT	500	05 - 09	HF184	478088	HFA5201	527098
500 SCARABEO LIGHT	500	06 - 13	HF184	478088	HFA5201	527098
550 RXV ENDURO	550	06 - 14	HF563	502307	HFA6101	513380
550 SXV SUPER MOTO	550	06 - 14	HF563	502307	HFA6101	513380
550 SXV STREET LEGAL	550	9	HF563	502307	HFA6101	513380
650 PEGASO	650	97 - 99	HF151	512963	HFA6102	513381
650 PEGASO CUBE	650	0	HF151	512963	HFA6102	513381
650 PEGASO I.E.	650	01 - 04	HF151	512963	HFA6102	513381
650 PEGASO I.E. TUSCANY TIBET RAID	650	4	HF151	512963	HFA6102	513381
RSV 1000 R	1000	04 - 05	HF152	512964	HFA6101	513380
RSV 1000 R FACTORY	1000	04 - 09	HF152	512964	HFA6101	513380
RSV 1000 RSV4 R	1000	09 - 11	HF138	487429	HFA6101	513380
RSV 1000 RSV4 R APRC / ABS	1000	12 - 14	HF138	487429	HFA6101	513380
RSV 1000 R NERA	1000	04 - 08	HF152	512964	HFA6101	513380
RSV 1000 R TUONO	1000	04 - 10	HF152	512964	HFA6101	513380
RSV 1000 RSV4 V4R TUONO	1000	11 - 13	HF138	487429	HFA6101	513380
RSV 1000 RSV4 V4R TUONO APRC	1000	12 - 13	HF138	487429	HFA6101	513380
RSV 1000 RSV4 V4R TUONO APRC ABS	1000	14	HF138	487429	HFA6101	513380
RSV 1000 R TUONO FACTORY	1000	05 - 10	HF152	512964	HFA6101	513380
ARCTIC CAT						
400 DVX	400	04 - 08	HF139	512957	HFF3022	513459
400 DVX TS	400	06 - 07	HF139	512957	HFF3022	513459
BENELLI						
125 ADIVA	125	00 - 03	HF183	494342	HFA5209	502281
150 ADIVA	150	00 - 03	HF183	494342	HFA5209	502281
500 QUATTRO	500	73 - 76	HF401	512994	-	-
500 LS	500	77 - 82	HF401	512994	-	-
504 SPORT	504	77 - 82	HF401	512994	-	-
654 T / SPORT (4 CYL 4T)	504	80 - 86	HF401	512994	-	-
BETAMOTOR						
250 RR ENDURO 4T	250	05 - 09	HF155	512967	HFF6111	513492
350 RR ENDURO 4T	350	13 - 19	HF631	513012	HFF6112	513493
390 RR ENDURO 4T	390	15 - 19	HF631	513012	HFF6112	513493
390 RR ENDURO 4T RC	390	17 - 19	HF631	513012	HFF6112	513493
390 RS DUAL SPORT	390	15 - 16	HF631	513012	HFF6112	513493
400 RR ENDURO 4T	400	05 - 09	HF155	512967	HFF6111	513492
400 RR ENDURO 4T	400	10 - 12	HF631	513012	HFF6111	513492
400 RR ENDURO 4T	400	13 - 15	HF631	513012	HFF6112	513493
430 RR ENDURO 4T	430	15 - 19	HF631	513012	HFF6112	513493
430 RR ENDURO 4T RC	430	17 - 19	HF631	513012	HFF6112	513493
430 RR ENDURO 4T RC	430	15	HF631	513012	HFF6112	513493
450 RR ENDURO 4T	450	05 - 09	HF155	512967	HFF6111	513492
450 RR ENDURO 4T	450	10 - 12	HF631	513012	HFF6111	513492

Modèle	Cylindrée	Année	H.FLOFILTRO		H.FLOFILTRO	
			Filtre huile Réf. HilfoFiltro	Filtre huile Réf. CGN	Filtre air Réf. HilfoFiltro	Filtre air Réf. CGN
450 RR ENDURO 4T	450	13 - 15	HF631	513012	HFF6112	513493
450 RR CROSS COUNTRY 4T	450	11 - 12	HF631	513012	HFF6111	513492
450 RR CROSS COUNTRY 4T	450	13 - 16	HF631	513012	HFF6112	513493
480 RR ENDURO 4T	480	15 - 19	HF631	513012	HFF6112	513493
480 RR ENDURO 4T RC	480	15 - 19	HF631	513012	HFF6112	513493
498 RR ENDURO 4T	498	12 - 16	HF631	513012	HFF6112	513493
500 RS DUAL SPORT	500	15 - 16	HF631	513012	HFF6112	513493
520 RR ENDURO 4T	520	10 - 12	HF631	513012	HFF6111	513492
520 RR ENDURO 4T	520	13 - 14	HF631	513012	HFF6112	513493
525 RR ENDURO 4T	525	05 - 09	HF155	512967	HFF6111	513492
BMW						
125 C1	125	01 - 03	HF185	478083	HFA7101	502284
200 C1	200	02 - 03	HF185	478083	HFA7101	502284
C400 X	400	19	HF164	489951	HFA7920	527100
C400 X	400	20	HF164	489951	HFA7920	527100
C400 GT K08	400	19	HF164	489951	HFA7920	527100
C400 GT	400	20	HF164	489951	HFA7920	527100
C600 SPORT	650	11 - 15	HF164	489951	HFA7604	502285
C650 GT K19	650	11 - 18	HF164	489951	HFA7604	502285
C650 GT K19	650	19	HF164	489951	HFA7604	502285
C650 GT	650	20	HF164	489951	HFA7604	502285
C650 SPORT K19	650	15 - 18	HF164	489951	HFA7604	502285
C650 SPORT K19	650	19	HF164	489951	HFA7604	502285
C650 SPORT	650	20	HF164	489951	HFA7604	502285
F650 FUNDURO 169	650	93 - 96	HF151	512963	HFA7603	513403
F650 FUNDURO E169 MU	650	97 - 00	HF151	512963	HFA7603	513403
F650 ST STRADA 169	650	97 - 00	HF151	512963	HFA7603	513403
F650 GS R13	650	00 - 04	HF151	512963	HFA7601	513401
F650 GS E650G	650	05 - 07	HF151	512963	HFA7601	513401
F650 GS DAKAR R13	650	01 - 04	HF151	512963	HFA7601	513401
F650 GS DAKAR E650G	650	05 - 07	HF151	512963	HFA7601	513401
F650 CS K14 / E650C	650	02 - 05	HF151	512963	HFA7602	513402
G650 GS	650	09 - 11	HF151	512963	HFA7601	513401
G650 GS	650	12 - 16	HF151	512963	HFA7601	513401
G650 GS SERTA0	650	11 - 14	HF151	512963	HFA7601	513401
G650 XCHALLENGE	650	07 - 08	HF151	512963	HFA7602	513402
G650 XCOUNTRY	650	07 - 08	HF151	512963	HFA7602	513402
G650 XMOTO	650	07 - 08	HF151	512963	HFA7602	513402
F650 GS	800	08 - 11	HF160	512971	HFA7913	513407
F650 GS	800	12	HF160	512971	HFA7913	513407
F650 GS SE	800	12	HF160	512971	HFA7913	513407
F700 GS	800	13 - 18	HF160	512971	HFA7913	513407
F800 GS K72	800	07 - 11	HF160	512971	HFA7913	513407
F800 GS	800	12 - 18	HF160	512971	HFA7913	513407

Modèle	Cylindrée	Année	HIFLOFILTRO		HIFLOFILTRO	
			Filtre huile Réf. HiffoFiltro	Filtre huile Réf. CGN	Filtre air Réf. HiffoFiltro	Filtre air Réf. CGN
F800 GS ADVENTURE	800	12 - 18	HF160	512971	HFA7913	513407
F800 GS TRIPLE BLACK	800	12	HF160	512971	HFA7913	513407
F800 GS TROPHY	800	12	HF160	512971	HFA7913	513407
F800 GT	800	13 - 17	HF160	512971	HFA7913	513407
F800 R	800	10 - 17	HF160	512971	HFA7913	513407
F800 R CHRIS PFEIFFER REPLICA	800	10	HF160	512971	HFA7913	513407
F800 S	800	06 - 10	HF165	512974	HFA7913	513407
F800 ST	800	06 - 11	HF165	512974	HFA7913	513407
F800 ST	800	12 - 13	HF165	512974	HFA7913	513407
F800 ST TOURING	800	12	HF165	512974	HFA7913	513407
R850 GS BOXER	850	99	HF163	512973	HFA7910	513404
R850 R BOXER	850	99	HF163	512973	HFA7910	513404
R850 RT	850	99	HF163	512973	HFA7910	513404
R850 R	850	00 - 06	HF163	512973	HFA7910	513404
R850 R CLASSIC	850	02 - 04	HF163	512973	HFA7910	513404
F750 GS K80	853	17 - 18	HF160	512971	HFA7801	527099
F750 GS	853	19	HF160	512971	HFA7801	527099
F750 GS	853	20	HF160	512971	HFA7801	527099
F850 GS K81	853	17 - 18	HF160	512971	HFA7801	527099
F850 GS	853	19	HF160	512971	HFA7801	
F850 GS	853	20	HF160	512971	HFA7801	527099
F850 GS ADVENTURE	853	20	HF160	512971	HFA7801	527099
1000 HP4 K42	1000	11 - 14	HF160	512971	HFA7918	513412
1000 HP4 RACE K60	1000	17 - 18	HF160	512971	HFA7918	513412
S1000 R K47	1000	13 - 19	HF160	512971	HFA7918	513412
S1000 R	1000	20	HF160	512971	HFA7918	513412
S1000 RR K46	1000	10 - 18	HF160	512971	HFA7918	513412
S1000 RR K67	1000	19	HF160	512971	HFA7919	-
S1000 RR	1000	20	HF160	512971	HFA7919	-
S1000 RR SPORT K46	1000	10	HF160	512971	HFA7918	513412
S1000 XR	1000	15 - 19	HF160	512971	HFA7918	513412
S1000 XR	1000	20	HF160	512971	HFA7919	
R1100 GS	1100	93 - 99	HF163	512973	HFA7910	513404
R1100 RS	1100	93 - 01	HF163	512973	HFA7910	513404
R1100 RS SPECIAL EDITION	1100	0	HF163	512973	HFA7910	513404
R1100 R	1100	95 - 01	HF163	512973	HFA7910	513404
R1100 RT	1100	96 - 01	HF163	512973	HFA7910	513404
R1100 S	1100	99 - 05	HF163	512973	HFA7911	513405
R1100 S SPORTS BOXER	1100	0	HF163	512973	HFA7911	513405
R1100 S SPORT	1100	2	HF163	512973	HFA7911	513405
R1100 S PREP	1100	4	HF163	512973	HFA7911	513405
R1100 S REPLIKA	1100	03 - 04	HF163	512973	HFA7911	513405
R1150 GS	1150	99 - 05	HF163	512973	HFA7910	513404
R1150 GS ADVENTURE	1150	02 - 03	HF163	512973	HFA7910	513404
R1150 GS ADVENTURE	1150	04 - 05	HF163	512973	HFA7910	513404

Modèle	Cylindrée	Année	H.FLOFILTRO		H.FLOFILTRO	
			Filtre huile Réf. HilfoFiltro	Filtre huile Réf. CGN	Filtre air Réf. HilfoFiltro	Filtre air Réf. CGN
RI150 R	1150	01 - 06	HF163	512973	HFA7910	513404
RI150 R ROCKSTER	1150	04 - 05	HF163	512973	HFA7910	513404
RI150 R ROCKSTER EDITION 80	1150	4	HF163	512973	HFA7910	513404
RI150 RS	1150	02 - 05	HF163	512973	HFA7910	513404
RI150 RS SE	1150	02 - 05	HF163	512973	HFA7910	513404
RI150 RT	1150	02 - 05	HF163	512973	HFA7910	513404
R NINE T	1170	13 - 19	HF164	489951	HFA7914	513408
R NINE T	1170	20	HF164	489951	HFA7914	513408
R NINE T SCRAMBLER	1170	16 - 19	HF164	489951	HFA7914	513408
R NINE T SCRAMBLER	1170	20	HF164	489951	HFA7914	513408
R NINE T RACER	1170	16 - 19	HF164	489951	HFA7914	513408
R NINE T URBAN GS	1170	16 - 19	HF164	489951	HFA7914	513408
R NINE T URBAN GS	1170	20	HF164	489951	HFA7914	513408
RI200 GS	1200	04 - 08	HF164	489951	HFA7912	513406
RI200 GS	1200	9	HF164	489951	HFA7912	513406
RI200 GS	1200	10 - 12	HF164	489951	HFA7914	513408
RI200 GS LC K50	1200	13 - 18	HF160	512971	HFA7915	513409
RI200 GS TE	1200	14	HF160	512971	HFA7915	513409
RI200 GS ADVENTURE	1200	10 - 13	HF164	489951	HFA7914	513408
RI200 GS ADVENTURE TRIPLE BLACK	1200	12	HF164	489951	HFA7914	513408
RI200 GS ADVENTURE XE K51	1200	14	HF160	512971	HFA7915	513409
RI200 GS ADVENTURE TE K51	1200	14	HF160	512971	HFA7915	513409
RI200 GS ADVENTURE K51	1200	15 - 18	HF160	512971	HFA7915	513409
RI200 GS ENDURO	1200	13	HF160	512971	HFA7915	513409
RI200 GS RALLYE	1200	12	HF164	489951	HFA7914	513408
RI200 GS TRIPLE BLACK	1200	12	HF164	489951	HFA7914	513408
RI200 HP2 ENDURO	1200	05 - 08	HF164	489951	HFA7912	513406
RI200 HP2 MEGAMOTO	1200	07 - 08	HF164	489951	HFA7912	513406
RI200 HP2 SPORT	1200	08 - 09	HF164	489951	HFA7912	513406
RI200 R K27	1200	07 - 10	HF164	489951	HFA7912	513406
RI200 R K27	1200	11 - 14	HF164	489951	HFA7914	513408
RI200 R 90 YEARS SPECIAL K27	1200	14	HF164	489951	HFA7914	513408
RI200 R LC K53	1200	14 - 18	HF160	512971	HFA7915	513409
RI200 R CLASSIC	1200	12	HF164	489951	HFA7914	513408
RI200 RS LC K54	1200	14 - 18	HF160	512971	HFA7915	513409
RI200 RT K26	1200	05 - 09	HF164	489951	HFA7912	513406
RI200 RT K26	1200	10 - 14	HF164	489951	HFA7914	513408
RI200 RT 90 YEARS SPECIAL K26	1200	14	HF164	489951	HFA7914	513408
RI200 RT LC K52	1200	13 - 18	HF160	512971	HFA7915	513409
RI200 RT SE	1200	10 - 12	HF164	489951	HFA7914	513408
RI200 S	1200	06 - 09	HF164	489951	HFA7912	513406
RI200 ST	1200	05 - 08	HF164	489951	HFA7912	513406
RI250 GS	1250	19	HF160	512971	HFA7915	513409
RI250 GS	1250	20	HF160	512971	HFA7915	513409

MOTEUR

CYCLE

PNEUMATIQUE

ATELIER

ACCESSOIRES

ÉLECTRICITÉ

FILTRATION

FREINAGE

TRANSMISSION

Modèle	Cylindrée	Année	HIFLOFILTRO		HIFLOFILTRO	
			Filtre huile Réf. HiffoFiltro	Filtre huile Réf. CGN	Filtre air Réf. HiffoFiltro	Filtre air Réf. CGN
R1250 GS ADVENTURE	1250	19	HF160	512971	HFA7915	513409
R1250 GS ADVENTURE	1250	20	HF160	512971	HFA7915	513409
R1250 R	1250	19	HF160	512971	HFA7915	513409
R1250 R	1250	20	HF160	512971	HFA7915	513409
R1250 RS	1250	19	HF160	512971	HFA7915	513409
R1250 RS	1250	20	HF160	512971	HFA7915	513409
R1250 RT	1250	19	HF160	512971	HFA7915	513409
R1250 RT	1250	20	HF160	512971	HFA7915	513409
K1300 GT	1300	09 - 10	HF160	512971	HFA7917	513411
K1300 GT SE	1300	10	HF160	512971	HFA7917	513411
K1300 R	1300	09 - 16	HF160	512971	HFA7917	513411
K1300 R CARBON	1300	12	HF160	512971	HFA7917	513411
K1300 R DYNAMIC	1300	12 - 16	HF160	512971	HFA7917	513411
K1300 S (2PCS X HFA7917 REQUIRED)	1300	09 - 16	HF160	512971	HFA7917	513411
K1300 S HP (2PCS X HFA7917 REQUIRED)	1300	12	HF160	512971	HFA7917	513411
K1300 S SPORT (2PCS X HFA7917 REQUIRED)	1300	12	HF160	512971	HFA7917	513411
K1600 GT K48	1600	11 - 19	HF164	489951	HFA7916	513410
K1600 GT	1600	20	HF164	489951	HFA7916	513410
K1600 GT SE	1600	12	HF164	489951	HFA7916	513410
K1600 GTL K48	1600	11 - 19	HF164	489951	HFA7916	513410
K1600 GTL	1600	20	HF164	489951	HFA7916	513410
K1600 GTL EXCLUSIVE K48	1600	13 - 16	HF164	489951	HFA7916	513410
K1600 GTL SE	1600	12	HF164	489951	HFA7916	513410
K1600 BAGGER K61	1600	17 - 18	HF164	489951	HFA7916	513410
K1600 B	1600	19	HF164	489951	HFA7916	513410
K1600 B	1600	20	HF164	489951	HFA7916	513410
CAGIVA						
650 RAPTOR I.E.	650	00 - 05	HF138	487429	HFA3609	513259
650 V-RAPTOR	650	01 - 04	HF138	487429	HFA3609	513259
750 ELEFANT / LUCKY EXPLORER	750	93 - 97	HF153	512965	HFA6201	513391
900 ELEFANT IE GT / LUCKY EXPLORER	900	90 - 92	HF153	512965	HFA6202	513392
900 ELEFANT / LUCK EXPLORER	900	93 - 97	HF153	512965	HFA6201	513391
900 GRAND CANYON	900	90 - 92	HF153	512965	HFA6202	513392
1000 RAPTOR	1000	00 - 05	HF138	487429	HFA3901	513279
1000 V-RAPTOR	1000	00 - 04	HF138	487429	HFA3901	513279
1000 XTRA-RAPTOR	1000	01 - 05	HF138	487429	HFA3901	513279
1000 NAVIGATOR	1000	00 - 05	HF138	487429	HFA6202	513392
DERBI						
125 RAMBLA	125	08 - 13	HF183	494342	HFA5201	527098
125/150 SONAR	125	10 - 13	HF183	494342	HFA5205	513360
125 TERRA 4T	125	07 - 09	HF563	502307	HFA6112	527097
125 VARIANT SPORT 4T	125	12 - 15	HF183	494342	HFA5202	513359
200 BOULEVARD	200	02 - 08	HF183	494342	HFA5209	502281
250 RAMBLA	250	08 - 10	HF183	494342	HFA5201	527098
300I RAMBLA	300	10 - 13	HF183	494342	HFA5201	527098

Modèle	Cylindrée	Année	H.FLOFILTRO		H.FLOFILTRO	
			Filtre huile Réf. HilfoFiltro	Filtre huile Réf. CGN	Filtre air Réf. HilfoFiltro	Filtre air Réf. CGN
660 MULHACEN	660	06 - 08	HF145	487430	HFA6112	527097
DUCATI						
400 SS JUNIOR SUPER SPORT	400	92 - 94	HF153	512965	HFA6002	513379
400 SCRAMBLER SIXTY2	400	16 - 18	HF153	512965	HFA6001	513378
400 SCRAMBLER SIXTY2	400	19 - 20	HF153	512965	HFA6001	513378
600 MONSTER	600	93 - 01	HF153	512965	HFA6002	513379
600 SS	600	93 - 98	HF153	512965	HFA6002	513379
620 SPORT	620	3	HF153	512965	HFA6002	513379
696 MONSTER	696	09 - 14	HF153	512965	HFA6001	513378
750 PASO	750	86 - 90	HF153	512965	HFA6002	513379
750 SPORT	750	88 - 90	HF153	512965	HFA6002	513379
750 SPORT	750	01 - 02	HF153	512965	HFA6002	513379
750 SS	750	91 - 02	HF153	512965	HFA6002	513379
750 MONSTER	750	96 - 01	HF153	512965	HFA6002	513379
796 MONSTER	796	11 - 15	HF153	512965	HFA6001	513378
796 HYPERMOTARD	796	10 - 12	HF153	512965	HFA6001	513378
796 MONSTER	796	17	HF153	512965	HFA6001	513378
797 MONSTER	797	18	HF153	512965	HFA6001	513378
797 MONSTER +	797	18	HF153	512965	HFA6001	513378
797 MONSTER	797	19 - 20	HF153	512965	HFA6001	513378
797 MONSTER +	797	19 - 20	HF153	512965	HFA6001	513378
800 SCRAMBLER CAFE RACER	800	18 - 19	HF153	512965	HFA6001	513378
800 SCRAMBLER CAFE RACER	800	20	HF153	512965	HFA6001	513378
800 SCRAMBLER CLASSIC	800	15 - 18	HF153	512965	HFA6001	513378
800 SCRAMER DESERT SLED	800	18 - 19	HF153	512965	HFA6001	513378
800 SCRAMER DESERT SLED	800	20	HF153	512965	HFA6001	513378
800 SCRAMBLER FLAT TRACK PRO	800	15 - 16	HF153	512965	HFA6001	513378
800 SCRAMBLER FULL THROTTLE	800	15 - 19	HF153	512965	HFA6001	513378
800 SCRAMBLER ICON	800	15 - 19	HF153	512965	HFA6001	513378
800 SCRAMBLER ICON	800	20	HF153	512965	HFA6001	513378
800 SCRAMBLER ICON DARK	800	20	HF153	512965	HFA6001	513378
800 SCRAMBLER URBAN ENDURO	800	15 - 16	HF153	512965	HFA6001	513378
800 SCRAMBLER MACH 2	800	17 - 18	HF153	512965	HFA6001	513378
800 SPORT	800	3	HF153	512965	HFA6002	513379
800 SS	800	03 - 07	HF153	512965	HFA6002	513379
821 HYPERMOTARD / SP	821	13 - 18	HF153	512965	HFA6001	513378
821 HYPERSTRADA	821	13 - 18	HF153	512965	HFA6001	513378
821 MONSTER / DARK / STRIPE	821	14 - 17	HF153	512965	HFA6001	513378
821 MONSTER	821	19 - 20	HF153	512965	HFA6001	513378
821 MONSTER STEALTH	821	19 - 20	HF153	512965	HFA6001	513378
851 STRADA	851	89 - 92	HF153	512965	HFA6002	513379
888 STRADA	888	92 - 94	HF153	512965	HFA6002	513379
900 MONSTER	900	93 - 01	HF153	512965	HFA6002	513379
900 SUPER SPORT	900	90 - 02	HF153	512965	HFA6002	513379

MOTEUR

CYCLE

PNEUMATIQUE

ATELIER

ACCESSOIRES

ÉLECTRICITÉ

FILTRATION

FREINAGE

TRANSMISSION

Modèle	Cylindrée	Année	HIFLOFILTRO		HIFLOFILTRO	
			Filtre huile Réf. HifloFiltro	Filtre huile Réf. CGN	Filtre air Réf. HifloFiltro	Filtre air Réf. CGN
900 SUPER LIGHT	900	92 - 97	HF153	512965	HFA6002	513379
900 FE	900	98	HF153	512965	HFA6002	513379
906 PASO SPORTS	906	88 - 91	HF153	512965	HFA6002	513379
907 I.E.	907	90 - 93	HF153	512965	HFA6002	513379
916 ST4	916	99 - 03	HF153	512965	HFA6002	513379
939 HYPERMOTARD	939	16 - 19	HF153	512965	HFA6001	513378
939 HYPERMOTARD SP	939	16 - 19	HF153	512965	HFA6001	513378
939 HYPERSTRADA	939	16	HF153	512965	HFA6001	513378
939 SUPERSPORT	939	17 - 19	HF153	512965	HFA6001	513378
939 SUPERSPORT	939	20	HF153	512965	HFA6001	513378
939 SUPERSPORT S	939	17 - 19	HF153	512965	HFA6001	513378
939 SUPERSPORT S	939	20	HF153	512965	HFA6001	513378
944 ST2	944	97 - 03	HF153	512965	HFA6002	513379
950 HYPERMOTARD	950	19	HF153	512965	HFA6001	513378
950 HYPERMOTARD SP	950	19	HF153	512965	HFA6001	513378
950 HYPERMOTARD	950	20	HF153	512965	HFA6001	513378
950 HYPERMOTARD SP	950	20	HF153	512965	HFA6001	513378
992 ST3	992	04 - 07	HF153	512965	HFA6002	513379
992 ST3 S (ABS) (USA)	992	7	HF153	512965	HFA6002	513379
996 ST4 S	996	02 - 05	HF153	512965	HFA6002	513379
996 ST4 S (ABS)	996	03 - 05	HF153	512965	HFA6002	513379
1000 GT SPORTCLASSIC	1000	07 - 10	HF153	512965	HFA6001	513378
1000 GT SPORTCLASSIC TOURING	1000	9	HF153	512965	HFA6001	513378
1000 SS	1000	03 - 05	HF153	512965	HFA6002	513379
1100 MONSTER	1100	08 - 10	HF153	512965	HFA6001	513378
1100 MONSTER EVO	1100	11 - 13	HF153	512965	HFA6001	513378
1100 MONSTER S	1100	08 - 10	HF153	512965	HFA6001	513378
1100 MONSTER DIESEL	1100	13 - 14	HF153	512965	HFA6001	513378
1100 HYPERMOTARD / S	1100	08 - 09	HF153	512965	HFA6001	513378
1100 HYPERMOTARD EVO	1100	10 - 11	HF153	512965	HFA6001	513378
1100 HYPERMOTARD EVO	1100	12	HF153	512965	HFA6001	513378
1100 HYPERMOTARD SP EVO	1100	10 - 11	HF153	512965	HFA6001	513378
1100 HYPERMOTARD SP EVO CORSE EDITION	1100	12	HF153	512965	HFA6001	513378
1200 MONSTER	1200	14 - 19	HF153	512965	HFA6001	513378
1200 MONSTER	1200	20	HF153	512965	HFA6001	513378
1200 MONSTER S	1200	14 - 19	HF153	512965	HFA6001	513378
1200 MONSTER S	1200	20	HF153	512965	HFA6001	513378
1200 MONSTER S STRIPE	1200	16 - 17	HF153	512965	HFA6001	513378
1200 MONSTER R	1200	16 - 19	HF153	512965	HFA6001	513378
GILERA						
125 DNA	125	01 - 03	HF183	494342	HFA5213	502282
125 NEXUS	125	07 - 08	HF183	494342	HFA5201	527098
125 NEXUS I.E.	125	08 - 15	HF183	494342	HFA5201	527098
125 RUNNER VX / VXR / SC / ST / RACE	125	02 - 14	HF183	494342	HFA5201	527098

Modèle	Cylindrée	Année	H.FLOFILTRO		H.FLOFILTRO	
			Filtre huile Réf. HilfoFiltro	Filtre huile Réf. CGN	Filtre air Réf. HilfoFiltro	Filtre air Réf. CGN
125 RUNNER VX SOUL / SPORT	125	14 - 15	HF183	494342	HFA5201	527098
180 DNA	180	01 - 03	HF183	494342	HFA5213	502282
180 RUNNER VXR 4T	180	00 - 01	HF183	494342	HFA5213	502282
200 RUNNER VX / VXR / SC / ST / RACE	200	03 - 15	HF183	494342	HFA5201	527098
250 NEXUS / SP	250	06 - 08	HF183	494342	HFA5201	527098
250 OREGON (ATV)	250	07 - 08	HF183	494342	HFA5203	502279
300 NEXUS I.E.	300	08 - 15	HF183	494342	HFA5201	527098
500 FUOCO / LT	500	07 - 15	HF184	478088	HFA5201	527098
500 NEXUS / SP	500	03 - 15	HF184	478088	HFA5219	513375
HM MOTO						
250 CRE-F R 4T	250	4	HF116	508613	HFF1018	513419
250 CRE-F R 4T	250	05 - 09	HF116	508613	HFF1018	513419
250 CRM-F X IE 4T	250	07 - 08	HF116	508613	HFF1018	513419
290 CRE-F X IE 4T	250	07 - 08	HF116	508613	HFF1018	513419
290 CRM-F X IE 4T	250	07 - 08	HF116	508613	HFF1018	513419
300 CRE-F X IE 4T	300	08 - 10	HF116	508613	HFF1018	513419
450 CRE-F R	450	2	HF116	508613	HFF1016	513417
450 CRE-F R	450	03 - 04	HF116	508613	HFF1018	513419
450 CRE-F R	450	05 - 08	HF116	508613	HFF1018	513419
450 CRE-F R	450	09 - 13	HF116	508613	HFF1022	513423
450 CRE-F X	450	05 - 09	HF116	508613	HFF1018	513419
450 CRE-F X IE	450	07 - 09	HF116	508613	HFF1018	513419
450 CRM-F R	450	2	HF116	508613	HFF1016	513417
450 CRM-F R	450	03 - 04	HF116	508613	HFF1018	513419
450 CRM-F R	450	05 - 08	HF116	508613	HFF1018	513419
450 CRM-F R	450	09 - 13	HF116	508613	HFF1022	513423
450 CRM-F X	450	05 - 09	HF116	508613	HFF1018	513419
450 CRM-F X IE	450	07 - 09	HF116	508613	HFF1018	513419
490 CRE-F X IE	490	07 - 08	HF116	508613	HFF1018	513419
490 CRM-F X IE	490	07 - 08	HF116	508613	HFF1018	513419
500 CRE-X	500	08 - 13	HF116	508613	HFF1018	513419
500 CRM-X	500	09 - 13	HF116	508613	HFF1018	513419
HONDA						
CRF150 R-7, 8, 9, A, B, C, D, E, F, G, H, J, K, L, M	150	07 - 21	HF116	508613	HFF1021	513422
CRF150 RB-7, 8, 9, A, B, C, D, E, F, G, H, J, K, L, M	150	07 - 19	HF116	508613	HFF1021	513422
CB250 N, NA, T	250	78 - 82	HF111	512943	HFA1210	513109
CB250 NDX-B, NB	250	78 - 82	HF111	512943	HFA1210	513109
CB250 NB, NDX-B SUPER DREAM	250	81 - 85	HF111	512943	HFA1210	513109
CM250 TB CUSTOM	250	81 - 85	HF111	512943	HFA1210	513109
CRF250 L-D, E, F, G	250	13 - 16	HF112	512944	HFA1215	513113
CRF250 M-E, F	250	14 - 15	HF112	512944	HFA1215	513113
CRF250 R-4, 5, 6, 7, 8, 9	250	04 - 09	HF116	508613	HFF1018	513419
CRF250 R-A, B, C, D	250	10 - 13	HF116	508613	HFF1022	513423

Modèle	Cylindrée	Année	HIFLOFILTRO		HIFLOFILTRO	
			Filtre huile Réf. HifloFiltro	Filtre huile Réf. CGN	Filtre air Réf. HifloFiltro	Filtre air Réf. CGN
CRF250 R-E, F, G, H	250	14 - 17	HF116	508613	HFF1025	513426
CRF250 R-J, K	250	18 - 19	HF116	508613	HFF1026	513427
CRF250 R-L	250	20	HF116	508613	HFF1030	-
CRF250 R-M	250	21	HF116	508613	HFF1030	-
CRF250 RX-K	250	19	HF116	508613	HFF1026	513427
CRF250 RX-L	250	20	HF116	508613	HFF1030	-
CRF250 RX-M	250	21	HF116	508613	HFF1030	-
CRF250 X-4, 5, 6, 7, 8, 9, A, B, C, D, E, F, G, H, J, K	250	04 - 19	HF116	508613	HFF1018	513419
CRF250 XRL	250	15 - 17	HF116	508613	HFF1018	513419
NSS250 FORZA X/ EX-8	250	8	HF204	487431	HFA1507	513127
NSS250 FORZA A/ S - 8, 9, A, B, C EITHER OIL FILTER LISTED IS A SUITABLE REPLACEMENT	250	08 - 12	HF204	487431	HFA1507	513127
NX250 MD21/MD25	250	88 - 95	HF112	512944	HFA1209	513108
XR250 L (HFF1015 FOAM FILTER TO FIT WITH HFF1015C FILTER CAGE)	250	91 - 99	HF112	512944	HFF1015	513416
XR250 RG, RH (HFF1015 FOAM FILTER TO FIT WITH HFF1015C ME06 FILTER CAGE)	250	86 - 87	HF112	512944	HFF1015	513416
XR250 RJ, RK (HFF1015 FOAM FILTER TO FIT WITH HFF1015C ME06 FILTER CAGE)	250	88 - 89	HF112	512944	HFF1015	513416
XR250 R-L, M, N, P, R, S, T, V, W, X, Y, 1, 2, 3, 4 (HFF1015 FOAM FILTER TO FIT WITH HFF1015C FILTER CAGE)	250	90 - 04	HF112	512944	HFF1015	513416
XR250 SUPER (HFF1015 FOAM FILTER TO FIT WITH HFF1015C FILTER CAGE)	250	97 - 04	HF112	512944	HFF1015	513416
750 INTEGRA NC750 D-E, F, G, H, J, K DCT ENGINE FILTER TRANSMISSION FILTER	750	14 - 20	HF204	487431	HFA1715	502245
VF750 C V45 MAGNA RC09	750	82 - 83	HF202	512992	HFA1702	513148
VFR750 FG, FH RC24	750	86 - 87	HF202	512992	HFA1707	513153
VFR750 FJ, FK RC24	750	88 - 89	HF303	493942	HFA1707	513153
VFR750 FL, FM, FN, FP, FR, FS RC36	750	90 - 95	HF303	493942	HFA1709	513155
VFR750 FT, FV, FW	750	96 - 98	HF303	493942	HFA1709	513155
VT750 C CD CD2 SHADOW RC44	750	97 - 02	HF303	493942	HFA1710	513156
VT750 C, CA, CF SHADOW AERO RC50	750	04 - 20	HF204	487431	HFA1712	513158
VT750 C SHADOW	750	8	HF204	487431	HFA1712	513158
VT750 CD SHADOW A.C.E. 750 DELUXE	750	02 - 03	HF303	493942	HFA1710	513156
VT750 C2 SHADOW	750	99 - 01	HF303	493942	HFA1710	513156
VT750 C2 SHADOW SPIRIT	750	04 - 15	HF204	487431	HFA1712	513158
VT750 C2B SHADOW PHANTOM / BLACK SPIRIT RC53	750	10 - 20	HF204	487431	HFA1712	513158
VT750 CS SHADOW RC50C	750	10 - 20	HF204	487431	HFA1712	513158
VT750 DC SHADOW SPIRIT	750	01 - 07	HF303	493942	HFA1710	513156
VT750 RS SHADOW RC58	750	10 - 13	HF204	487431	HFA1712	513158
VT750 S-B, C, D RC58	750	11 - 13	HF204	487431	HFA1712	513158
XRV750 AFRICA TWIN RD04	750	90 - 92	HF303	493942	HFA1705	513151
XRV750 AFRICA TWIN RD07	750	93 - 02	HF303	493942	HFA1708	513154
X-ADV 750 ADV750 H, J, K, L ENGINE FILTER TRANSMISSION FILTER	750	17 - 19	HF204	487431	HFA1716	-

Modèle	Cylindrée	Année	H.FLOFILTRO		H.FLOFILTRO	
			Filtre huile Réf. HilfoFiltro	Filtre huile Réf. CGN	Filtre air Réf. HilfoFiltro	Filtre air Réf. CGN
VFR800 F1-W, X INTERCEPTOR RC46	800	98 - 99	HF303	493942	HFA1801	513161
VFR800 F1-Y, 1 INTERCEPTOR (CBS & PGM) RC46	800	00 - 01	HF303	493942	HFA1801	513161
VFR800 F1-2, 3 INTERCEPTOR RC46	800	02 - 03	HF204	487431	HFA1801	513161
VFR800 F1-4, 5, 6, 7, 8, 9, A, B INTERCEPTOR V TEC RC46	800	04 - 11	HF204	487431	HFA1801	513161
VFR800 F1-2, 3, 4, 5, 6, 7, 8,9, A, B, C, D, E, F, G, H INTERCEPTOR V RC46 TEC (ABS)	800	02 - 19	HF204	487431	HFA1801	513161
VFR800 X-B, C, D, E, F, G, H CROSSRUNNER	800	11 - 17	HF204	487431	HFA1801	513161
VT800 SHADOW	800	88	HF202	512992	HFA1711	513157
CB900 F-Z, A, B, C, D	900	79 - 82	HF401	512994	HFA1706	513152
CB900 BOL D'OR	900	79 - 82	HF401	512994	HFA1706	513152
CB900 F2B, F2C, F2D	900	83 - 84	HF401	512994	HFA1706	513152
CB900 C CUSTOM	900	80 - 82	HF401	512994	HFA1706	513152
CB900 F 900 SUPERSPORT	900	79 - 82	HF401	512994	HFA1706	513152
CB900 F HORNET SC48	900	02 - 07	HF204	487431	HFA1916	513177
CB900 F 919 (USA)	900	02 - 07	HF204	487431	HFA1916	513177
CB900 RR-N, P, R, S FIRE BLADE SC28	900	92 - 95	HF303	493942	HFA1901	513162
CB900 RR-T, V, W, X FIRE BLADE	900	96 - 99	HF303	493942	HFA1901	513162
CB900 RR-2, 3 FIRE BLADE	900	02 - 03	HF204	487431	HFA1918	513179
CB954 RR (USA)	900	02 - 03	HF204	487431	HFA1918	513179
CB1000 C CUSTOM	1000	83	HF401	512994	HFA1706	513152
CB1000 FP, FR, FS, FT, FV BIG 1 SC30	1000	93 - 97	HF303	493942	HFA1914	513175
CB1000 R/RA-8, 9, A, B, C, D, E, F, G SC60	1000	08 - 16	HF204	487431	HFA1929	513189
CBF1000 A/S/T-6, 7, 8, 9, A SC58	1000	06 - 10	HF204	487431	HFA1927	513187
CBF1000 B, C, D, E, F	1000	11 - 15	HF204	487431	HFA1929	513189
CBF1000 F LTD ED.	1000	9	HF204	487431	HFA1927	513187
CBF1000 F TRAVEL	1000	07 - 10	HF204	487431	HFA1927	513187
CBF1000 F (ABS) SC58	1000	06 - 10	HF204	487431	HFA1927	513187
CBF1000 F/FA-B, C, D, E, F, G	1000	11 - 16	HF204	487431	HFA1929	513189
CBR1000 FH, FJ SC21	1000	87 - 88	HF303	493942	HFA1903	513164
CBR1000 FK, FL, FM, FN SC24	1000	89 - 92	HF303	493942	HFA1903	513164
CBR1000 FP, FR SC25	1000	93 - 94	HF303	493942	HFA1903	513164
CBR1000 FS, FT, FV, FW, FX	1000	95 - 99	HF303	493942	HFA1903	513164
CBR1000 F HURRICANE	1000	87 - 95	HF303	493942	HFA1903	513164
CBR1000 RR-4, 5, 6, 7 FIREBLADE (REQUIRES 2 X AIR FILTERS) SC57	1000	04 - 07	HF204	487431	HFA1919	513180
CBR1000 RR-8, 9, A, B, C, D, E, F, G FIREBLADE SC59	1000	08 - 16	HF204	487431	HFA1931	-
CBR1000 RR-H, J, K FIREBLADE	1000	17 - 19	HF204	487431	HFA1934	513191
CBR1000 RR-E, F, G FIREBLADE SP	1000	14 - 16	HF204	487431	HFA1931	-
CBR1000 RA-A, B, C, D, E, F, G FIREBLADE (C-ABS)	1000	10 - 16	HF204	487431	HFA1931	-
CBR1000 RA-H, J, K FIREBLADE (C-ABS)	1000	17 - 19	HF204	487431	HFA1934	513191
CBR1000 SP-G (USA)	1000	15 - 16	HF204	487431	HFA1931	-
CBR1000 SI-SIH, SIJ, SIK	1000	17 - 19	HF204	487431	HFA1934	513191

MOTEUR

CYCLE

PNEUMATIQUE

ATELIER

ACCESSOIRES

ÉLECTRICITÉ

FILTRATION

FREINAGE

TRANSMISSION

Modèle	Cylindrée	Année	HIFLOFILTRO		HIFLOFILTRO	
			Filtre huile Réf. HifloFiltro	Filtre huile Réf. CGN	Filtre air Réf. HifloFiltro	Filtre air Réf. CGN
CBR1000 S2-S2H, S2J	1000	17 - 18	HF204	487431	HFA1934	513191
CBX1000 B, C PROLINK SC06	1000	80 - 82	HF401	512994	HFA1902	513163
CRF1000 L-G, H, J AFRICA TWIN (REQUIRES 2 X AIR FILTERS) (AUSTRALIA)	1000	16 - 18	HF204	487431	HFA1933	-
CRF1000 A-G, H, J AFRICA TWIN (REQUIRES 2 X AIR FILTERS)	1000	16 - 19	HF204	487431	HFA1933	-
CRF1000 A2-J AFRICA TWIN SP (REQUIRES 2 X AIR FILTERS)	1000	18	HF204	487431	HFA1933	-
CRF1000 A2-K AFRICA TWIN ADVENTURE (REQUIRES 2 X AIR FILTERS)	1000	19	HF204	487431	HFA1933	-
CRF1000 D-G, H, J, K AFRICA TWIN DCT (REQUIRES 2 X AIR ENGINE FILTER FILTERS)	1000	16 - 19	HF204	487431	HFA1933	-
CRF1000 D2-J AFRICA TWIN SP DCT (REQUIRES 2 X AIR ENGINE FILTER FILTERS)	1000	18	HF204	487431	HFA1933	-
CRF1000 D2-K AFRICA TWIN ADVENTURE DCT (REQUIRES 2 X AIR FILTERS)	1000	19	HF204	487431	HFA1933	-
GL1000 GOLD WING	1000	75 - 80	HF401	512994	HFA1904	513165
GL1000 L, Z, LTD	1000	75 - 79	HF401	512994	HFA1904	513165
RC51 (RV1000 R) (REQUIRES 2 X AIR FILTERS) (USA) RC51	1000	00 - 06	HF204	487431	HFA1920	513181
VF1000 FE, FF, F2F SC15	1000	84 - 85	HF202	512992	HFA1907	513168
VF1000 RE SC16	1000	84	HF202	512992	HFA1907	513168
VF1000 RF, RG SC16	1000	85 - 86	HF202	512992	HFA1907	513168
VF1000 F INTERCEPTOR	1000	84 - 85	HF202	512992	HFA1907	513168
VTR1000 F FIRE STORM SC36	1000	97 - 02	HF303	493942	HFA1909	513170
VTR1000 F FIRE STORM SC36	1000	03 - 05	HF204	487431	HFA1909	513170
VTR1000 F SUPER HAWK	1000	98 - 02	HF303	493942	HFA1909	513170
VTR1000 F SUPER HAWK	1000	03 - 05	HF204	487431	HFA1909	513170
VTR1000 SP-1 (REQUIRES 2 X AIR FILTERS) RC51	1000	0	HF303	493942	HFA1920	513181
VTR1000 SP-1, SP-2 (REQUIRES 2 X AIR FILTERS) SC45	1000	01 - 06	HF204	487431	HFA1920	513181
XL1000 V-X, Y, 1, 2 VARADERO SD01, SD02	1000	99 - 02	HF303	493942	HFA1909	513170
XL1000 V-3, 4, 5, 6, 7, 8, 9, A, B, C, D VARADERO SD02	1000	03 - 13	HF204	487431	HFA1922	513183
XL1000 VA-5, 6, 7, 8, 9, A, B, C VARADERO (ABS) SD02	1000	05 - 13	HF204	487431	HFA1922	513183
XL1000 V-5, 6, 7, 8, 9 VARADERO TRAVEL	1000	05 - 09	HF204	487431	HFA1922	513183
XL1000 V-9 VARADERO COMFORT	1000	9	HF204	487431	HFA1922	513183
CB1100 RB SC05	1100	81	HF401	512994	HFA1706	513152
CB1100 RC, RD SC08	1100	82 - 83	HF401	512994	HFA1706	513152
CB1100 F SC11	1100	83	HF401	512994	HFA1706	513152
CB1100 SF-Y, 1, 2 X-ELEVEN	1100	00 - 03	HF303	493942	HFA1915	513176
CB1100 D, E, F, G	1100	13 - 16	HF204	487431	HFA1932	-
CB1100 CA-H	1100	18	HF204	487431	HFA1932	-
CB1100 NA-H	1100	18	HF204	487431	HFA1932	-
CB1100 EX-E, F, G, H, J, K, L	1100	15 - 20	HF204	487431	HFA1932	-
CB1100 RS-H, J, K, L	1100	17 - 20	HF204	487431	HFA1932	-

Modèle	Cylindrée	Année	H.FLOFILTRO		H.FLOFILTRO	
			Filtre huile Réf. HilfoFiltro	Filtre huile Réf. CGN	Filtre air Réf. HilfoFiltro	Filtre air Réf. CGN
CBR1100 XX-V, W BLACKBIRD SC35	1100	97 - 98	HF303	493942	HFA1910	513171
CBR1100 XX-X, Y, 1, 2, 3, 4, 5, 6 BLACKBIRD SC35	1100	99 - 06	HF303	493942	HFA1915	513176
GL1100 GOLD WING	1100	80 - 85	HF401	512994	HFA1905	513166
GL1100 I INTERSTATE	1100	80 - 83	HF401	512994	HFA1905	513166
GL1100 A ASPENCADE	1100	82 - 83	HF401	512994	HFA1905	513166
ST1100 A, L-G	1100	90 - 95	HF303	493942	HFA1911	513172
ST1100 L, M, N, P, R, S, T, V, W, X, Y PAN EUROPEAN SC26	1100	90 - 00	HF303	493942	HFA1911	513172
ST1100 ABS-TSC SC26	1100	92 - 98	HF303	493942	HFA1911	513172
ST1100 X, Y, 1, 2 PAN EUROPEAN CBS-ABS-TSC SC26	1100	99 - 02	HF303	493942	HFA1911	513172
VT1100 C SHADOW	1100	87 - 88	HF202	512992	HFA1908	513169
VT1100 C SHADOW	1100	89 - 95	HF303	493942	HFA1908	513169
VT1100 C, C2, C2-2, C3 SHADOW 1100	1100	95 - 98	HF303	493942	HFA1908	513169
VT1100 C SHADOW SPIRIT	1100	99 - 07	HF303	493942	HFA1908	513169
VT1100 C2 SHADOW SABRE	1100	99 - 07	HF303	493942	HFA1908	513169
VT1100 C3 SHADOW AERO	1100	98 - 02	HF303	493942	HFA1908	513169
VT1100 D2 SHADOW	1100	99	HF303	493942	HFA1908	513169
VT1100 CT SHADOW AMERICAN CLASSIC EDITION	1100	98	HF303	493942	HFA1908	513169
VT1100 T SHADOW ACE TOUR	1100	98 - 02	HF303	493942	HFA1908	513169
GL1200 AE, AF, AG, AH	1200	84 - 88	HF401	512994	HFA1906	513167
GL1200 GOLD WING	1200	84 - 87	HF401	512994	HFA1906	513167
GL1200 A GOLD WING ASPENCADE	1200	84 - 87	HF401	512994	HFA1906	513167
GL1200 I GOLD WING INTERSTATE	1200	84 - 87	HF401	512994	HFA1906	513167
VFRI200 F V4	1200	10 - 12	HF204	487431	HFA1930	513190
VFRI200 F DCT V4	1200	10 - 12	HF204	487431	HFA1930	513190
VFRI200 X-C, D, E, F, G, H, J CROSSTOURER	1200	12 - 18	HF204	487431	HFA1930	513190
VFRI200 XD-E, F, G, H, J CROSSTOURER DCT	1200	14 - 18	HF204	487431	HFA1930	513190
VFRI200 X CROSSTOURER HIGHLAND T	1200	15	HF204	487431	HFA1930	513190
CB1300 F-3, 4, 5, 6, 7, 8, 9, A (ABS) SC54	1300	03 - 10	HF204	487431	HFA1917	513178
CB1300 S/SA-5, 6, 7, 8, 9, A, B, C, D (ABS) SC54	1300	05 - 13	HF204	487431	HFA1917	513178
ST1300 PAN EUROPEAN SC51	1300	02 - 15	HF204	487431	HFA1923	513184
ST1300 A ABS PAN EUROPEAN SC51	1300	02 - 15	HF204	487431	HFA1923	513184
ST1300 PA POLICE (USA)	1300	11 - 18	HF204	487431	HFA1923	513184
VT1300 CR, CRA STATELINE	1300	10 - 16	HF204	487431	HFA1928	513188
VT1300 CS, CSA SABRE	1300	10 - 15	HF204	487431	HFA1928	513188
VT1300 CT, CTA INTERSTATE	1300	10 - 15	HF204	487431	HFA1928	513188
VT1300 CX, CXA FURY	1300	10 - 20	HF204	487431	HFA1928	513188
VTX1300 C / R / T	1300	04 - 09	HF204	487431	HFA1925	513185
VTX1300 S RETRO SC52	1300	03 - 07	HF204	487431	HFA1925	513185
GL1500 GOLD WING	1500	88 - 93	HF303	493942	HFA1912	513173
GL1500 A GOLD WING ASPENCADE	1500	91 - 00	HF303	493942	HFA1912	513173

MOTEUR

CYCLE

PNEUMATIQUE

ATELIER

ACCESSOIRES

ÉLECTRICITÉ

FILTRATION

FREINAGE

TRANSMISSION

Modèle	Cylindrée	Année	HIFLOFILTRO		HIFLOFILTRO	
			Filtre huile Réf. HifloFiltro	Filtre huile Réf. CGN	Filtre air Réf. HifloFiltro	Filtre air Réf. CGN
GL1500 I GOLD WING INTERSTATE	1500	91 - 96	HF303	493942	HFA1912	513173
GL1500 SE GOLD WING	1500	90 - 01	HF303	493942	HFA1912	513173
GL1500 BLACK WIDOW	1500	1	HF303	493942	HFA1912	513173
GL1500 F6C VALKYRIE SC34	1500	97 - 03	HF303	493942	HFA1913	513174
GL1800 GOLD WING SC47	1800	01 - 17	HF204	487431	HFA1921	513182
GL1800 GOLD WING (ABS) SC47	1800	03 - 05	HF204	487431	HFA1921	513182
GL1800 GOLD WING DELUXE	1800	13 - 15	HF204	487431	HFA1921	513182
GL1800 B F6B GOLD WING	1800	13 - 14	HF204	487431	HFA1921	513182
GL1800 B F6B GOLD WING	1800	15 - 17	HF204	487431	HFA1921	513182
GL1800 C GOLD WING VALKYRIE	1800	14 - 15	HF204	487431	HFA1921	513182
GL1800 F6C GOLD WING	1800	14 - 16	HF204	487431	HFA1921	513182
GL1800 P GOLD WING PREMIUM AUDIO SC47	1800	06 - 07	HF204	487431	HFA1921	513182
GL1800 HP GOLD WING AUDIO/COMFORT SC47	1800	06 - 10	HF204	487431	HFA1921	513182
GL1800 HPN GOLD WING AUDIO/COMFORT/NAVI SC47	1800	06 - 10	HF204	487431	HFA1921	513182
GL1800 HPNA GOLD WING AUDIO/COMFORT/NAVI/ABS SC47	1800	06 - 10	HF204	487431	HFA1921	513182
GL1800 HPNM GOLD WING AUDIO/COMFORT/NAVI XM	1800	10	HF204	487431	HFA1921	513182
GL1800 HPNM GOLD WING AUDIO/COMFORT/NAVI XM ABS	1800	10	HF204	487431	HFA1921	513182
GL1800 BM GOLD WING AIRBAG	1800	10	HF204	487431	HFA1921	513182
VTX1800 C / F / N / R / S / T SC46	1800	02 - 08	HF204	487431	HFA1926	513186
TRX400 EX	400	99 - 00	HF113	487428	HFF1023	513424
TRX400 EX SPORTRAX	400	01 - 08	HF113	487428	HFF1023	513424
TRX400 FA FOURTRAX RANCHER AT	400	04 - 07	HF111	512943	HFF1023	513424
TRX400 FGA FOURTRAX RANCHER AT GPSCAPE	400	04 - 07	HF111	512943	HFF1023	513424
TRX400 X-9, A, B, C, D, E	400	09 - 14	HF112	512944	HFF1023	513424
TRX420 FA FOURTRAX RANCHER AT	420	09 - 14	HF114	512945	HFF1027	513428
TRX420 FA FOURTRAX RANCHER AT	420	15 - 20	HF114	512945	HFF1023	513424
TRX420 FA FOURTRAX RANCHER AT	420	21	HF114	512945	HFF1023	513424
TRX420 FE FOURTRAX RANCHER 4X4 ES	420	07 - 13	HF113	487428	HFF1027	513428
TRX420 FE FOURTRAX RANCHER 4X4 ES	420	14 - 20	HF113	487428	HFF1023	513424
TRX420 FE FOURTRAX RANCHER 4X4 ES	420	21	HF113	487428	HFF1023	513424
TRX420 FM FOURTRAX RANCHER 4X4	420	07 - 13	HF113	487428	HFF1027	513428
TRX420 FM FOURTRAX RANCHER 4X4	420	14 - 20	HF113	487428	HFF1023	513424
TRX420 FM FOURTRAX RANCHER 4X4	420	21	HF113	487428	HFF1023	513424
TRX420 FPA-9, A, B FOURTRAX RANCHER AT (POWER STEERING)	420	09 - 14	HF114	512945	HFF1027	513428
TRX420 FPE FOURTRAX RANCHER 4X4 ES (POWER STEERING)	420	09 - 13	HF113	487428	HFF1027	513428
TRX420 FPM FOURTRAX RANCHER 4X4 (POWER STEERING)	420	09 - 14	HF113	487428	HFF1027	513428
TRX420 TE FOURTRAX RANCHER ES	420	07 - 13	HF113	487428	HFF1027	513428
TRX420 TE FOURTRAX RANCHER ES	420	14 - 20	HF113	487428	HFF1023	513424

Modèle	Cylindrée	Année	H.FLOFILTRO		H.FLOFILTRO	
			Filtre huile Réf. HifloFiltro	Filtre huile Réf. CGN	Filtre air Réf. HifloFiltro	Filtre air Réf. CGN
TRX420 TE FOURTRAX RANCHER ES	420	21	HF113	487428	HFF1023	513424
TRX420 TM FOURTRAX RANCHER	420	07 - 13	HF113	487428	HFF1027	513428
TRX420 TM FOURTRAX RANCHER	420	14 - 20	HF113	487428	HFF1023	513424
TRX420 TM FOURTRAX RANCHER	420	21	HF113	487428	HFF1023	513424
TRX450 R	450	04 - 05	HF116	508613	HFF1024	513425
TRX450 ER (ELEC START)	450	06 - 14	HF116	508613	-	-
TRX500 FA FOURTRAX FOREMAN RUBICON	500	00 - 14	HF111	512943	HFF1029	-
TRX500 FA FOURTRAX FOREMAN RUBICON	500	15 - 19	HF114	512945	HFF1029	-
TRX500 FE FOURTRAX FOREMAN 4 X 4 ES	500	05 - 19	HF113	487428	HFF1029	-
TRX500 FGA FOURTRAX FOREMAN RUBICON GPSCAPE	500	04 - 08	HF111	512943	HFF1029	-
TRX500 FM FOURTRAX FOREMAN RUBICON 4 X 4	500	05 - 19	HF113	487428	HFF1029	-
TRX500 FPA FOURTRAX FOREMAN RUBICON GPSCAPE WITH EPS	500	09 - 14	HF111	512943	HFF1029	-
TRX500 FPE FOURTRAX FOREMAN 4 X 4 ES (POWER STEERING)	500	07 - 14	HF113	487428	HFF1029	-
TRX500 FPM FOURTRAX FOREMAN 4 X 4 ES (POWER STEERING)	500	08 - 14	HF113	487428	HFF1029	-
TRX500 TM FOURTRAX FOREMAN	500	05 - 06	HF113	487428	HFF1029	-
TRX520 FA FOURTRAX FOREMAN DCT EPS	520	20	HF114	512945	HFF1023	513424
TRX520 FA FOURTRAX FOREMAN DCT EPS	520	21	HF114	512945	HFF1023	513424
TRX520 FE FOUTTRAX 4X4 ES EPS	520	20	HF113	487428	HFF1023	513424
TRX520 FE FOUTTRAX 4X4 ES EPS	520	21	HF113	487428	HFF1023	513424
TRX520 FM FOUTTRAX 4X4 ES	520	20	HF113	487428	HFF1023	513424
TRX520 FM FOUTTRAX 4X4 ES	520	21	HF113	487428	HFF1023	513424
TRX650 FA FOURTRAX RINCON	650	03 - 05	HF111	512943	HFF1029	-
TRX650 FGA FOURTRAX RINCON GPSCAPE	650	04 - 05	HF111	512943	HFF1029	-
TRX680 FA-6, 7, 8, 9, A, B, C, D, E, F, G, H, J, K, L FOURTRAX RINCON	680	06 - 20	HF111	512943	HFF1029	-
TRX680 FA FOURTRAX RINCON	680	21	HF111	512943	HFF1029	-
TRX680 FGA-6, 7, 8, 9, A FOURTRAX RINCON GPSCAPE	680	06 - 10	HF111	512943	HFF1029	-
TRX700 XX-8, 9	700	08 - 11	HF112	512944	-	-
SXS500 M PIONEER 500	500	15 - 21	HF113	487428	HFF1023	513424
SXS520 M PIONEER 520	520	21	HF113	487428	-	-
MUV700 BIG RED	700	12 - 13	HF111	512943	-	-
SXS700 M2, M2D, M4, M4D PIONEER 700	700	14 - 20	HF111	512943	HFF1029	-
SXS700 M2, M2D, M4, M4D PIONEER 700	700	21	HF111	512943	HFF1029	-
SXS1000 PIONEER 1000 M3, M3D, M3L, M3P 1ST OIL FILTER 2ND OIL FILTER	1000	16 - 20	HF114	512945	-	-
SXS1000 PIONEER 1000 M3D, M3L, M3P 1ST OIL FILTER 2ND OIL FILTER	1000	21	HF114	512945	-	-
SXS1000 PIONEER 1000 M5D, M5L, M5P 1ST OIL FILTER 2ND OIL FILTER	1000	16 - 20	HF114	512945	-	-

MOTEUR

CYCLE

PNEUMATIQUE

ATELIER

ACCESSOIRES

ÉLECTRICITÉ

FILTRATION

FREINAGE

TRANSMISSION

Modèle	Cylindrée	Année	HIFLOFILTRO		HIFLOFILTRO		
			Filtre huile Réf. HiffoFiltro	Filtre huile Réf. CGN	Filtre air Réf. HiffoFiltro	Filtre air Réf. CGN	
SXS1000 PIONEER 1000 M5D, M5L, M5P 1ST OIL FILTER 2ND OIL FILTER	1000	21	HF114	512945	-	-	
SXS1000 TALON 1000 S2R 1ST OIL FILTER 2ND OIL FILTER	1000	19 - 20	HF114	512945	-	-	
SXS1000 TALON 1000 S2R 1ST OIL FILTER 2ND OIL FILTER	1000	21	HF114	512945	-	-	
SXS1000 TALON 1000 S2X 1ST OIL FILTER 2ND OIL FILTER	1000	19 - 20	HF114	512945	-	-	
SXS1000 TALON 1000 S2X 1ST OIL FILTER 2ND OIL FILTER	1000	21	HF114	512945	-	-	
SXS1000 TALON X-4 1000 S4 1ST OIL FILTER 2ND OIL FILTER	1000	19 - 20	HF114	512945	-	-	
SXS1000 TALON X-4 1000 S4 1ST OIL FILTER 2ND OIL FILTER	1000	21	HF114	512945	-	-	
HUSABERG						-	
ALL HUSABERG 4-STROKE MODELS		95 - 99	HF155	512967	-	-	
ALL HUSABERG 4-STROKE MODELS		00 - 03	HF155	512967	HFF6011	-	
TE125	125	12	-	-	HFF5016	513486	
TE125	125	13	-	-	HFF5018	513488	
FE250	250	13	HF655	513016	HFF5018	513488	
FE250	250	14	HF652	513015	HFF5018	513488	
TE250	250	11 - 12	-	-	HFF5016	513486	
TE250	250	13 - 14	-	-	HFF5018	513488	
TE300	300	11 - 12	-	-	HFF5016	513486	
TE300	300	13 - 14	-	-	HFF5018	513488	
FE350	350	13	HF652	513015	HFF5018	513488	
FE390 ENDURO	390	10 - 12	HF655	513016	HFF6013	513491	
FC450	450	04 - 06	HF155	512967	HFF6011	-	
FE450	450	04 - 08	HF155	512967	HFF6011	-	
FE450 ENDURO	450	09 - 12	HF655	513016	HFF6013	513491	
FE450 ENDURO	450	13 - 14	HF655	513016	HFF5018	513488	
FS450	450	04 - 08	HF155	512967	HFF6011	-	
FX450 CROSS COUNTRY	450	10 - 11	HF655	513016	HFF6013	513491	
FE501	501	13 - 14	HF655	513016	HFF5018	513488	
FC550	550	04 - 06	HF155	512967	HFF6011	-	
FE550	550	04 - 08	HF155	512967	HFF6011	-	
FS550	550	04 - 08	HF155	512967	HFF6011	-	
FE570 ENDURO	570	09 - 12	HF655	513016	HFF6013	513491	
FS570 SUPERMOTO	570	10 - 11	HF655	513016	HFF6013	513491	
FE650	650	04 - 08	HF155	512967	HFF6011	-	
FS650	650	04 - 08	HF155	512967	HFF6011	-	
HUSQVARNA						-	
CR125	125	90 - 13	-	-	HFF6012	513490	
WR125	125	90 - 13	-	-	HFF6012	513490	
SMR125 4T	125	12	HF140	512958	-	-	
SMS4 125 4T	125	11 - 13	HF140	512958	-	-	
TC125	125	16 - 20	-	-	HFF5019	502290	

Modèle	Cylindrée	Année	H.FLOFILTRO		H.FLOFILTRO	
			Filtre huile Réf. HilfoFiltro	Filtre huile Réf. CGN	Filtre air Réf. HilfoFiltro	Filtre air Réf. CGN
TC125	125	21	-	-	HFF5019	502290
TE125 4T	125	11 - 13	HF140	512958	-	-
TE125	125	16	-	-	HFF5018	513488
TX125	125	17 - 19	-	-	HFF5019	502290
TE150	150	17 - 19	-	-	HFF5019	502290
TE150 I	150	20	-	-	HFF5019	502290
TE150 I	150	21	-	-	HFF5019	502290
200 SVARTPILEN	200	20	HF155	512967	HFA6303	527101
CR250	250	90 - 11	-	-	HFF6012	513490
FC250	250	14 - 15	HF652	513015	HFF5018	513488
FC250	250	16 - 20	HF652	513015	HFF5019	502290
FC250	250	21	HF652	513015	HFF5019	502290
FE250	250	14 - 16	HF652	513015	HFF5018	513488
FE250	250	17 - 20	HF652	513015	HFF5019	502290
FE250	250	21	HF652	513015	HFF5019	502290
SM250 R	250	7	HF154	512966	HFF6012	513490
250 SVARTPILEN	250	20	HF155	512967	HFA6303	527101
TC250	250	02 - 07	HF154	512966	HFF6012	513490
TC250	250	8	HF563	502307	HFF6012	513490
TC250	250	09 - 13	HF116	508613	HFF6012	513490
TC250	250	14 - 16	-	-	HFF5018	513488
TC250	250	17 - 20	-	-	HFF5019	502290
TC250	250	21	-	-	HFF5019	502290
TC250 R	250	13	HF116	508613	HFF6012	513490
TE250	250	02 - 07	HF154	512966	HFF6012	513490
TE250	250	08 - 09	HF563	502307	HFF6012	513490
TE250	250	10 - 14	HF116	508613	HFF6012	513490
TE250	250	15 - 16	-	-	HFF5018	513488
TE250	250	17 - 18	-	-	HFF5019	502290
TE250I	250	18 - 20	-	-	HFF5019	502290
TE250I	250	21	-	-	HFF5019	502290
TE250 R	250	13	HF116	508613	HFF6012	513490
TE250 MEO REPLICA	250	11	HF116	508613	HFF6012	513490
TXC250	250	08 - 09	HF563	502307	HFF6012	513490
TXC250	250	10 - 14	HF116	508613	HFF6012	513490
TXC250 R	250	13	HF116	508613	HFF6012	513490
WR250	250	90 - 13	-	-	HFF6012	513490
TE300	300	16	-	-	HFF5018	513488
TE300	300	17 - 18	-	-	HFF5019	502290
TE300I	300	18 - 19	-	-	HFF5019	502290
TE300I	300	20	-	-	HFF5019	502290
TE300I JARVIS EDITION	300	20	-	-	HFF5019	502290
TE300I	300	21	-	-	HFF5019	502290
TX300	300	17 - 19	-	-	HFF5019	502290

MOTEUR

CYCLE

PNEUMATIQUE

ATELIER

ACCESSOIRES

ÉLECTRICITÉ

FILTRATION

FREINAGE

TRANSMISSION

Modèle	Cylindrée	Année	HIFLOFILTRO		HIFLOFILTRO	
			Filtre huile Réf. HiffoFiltro	Filtre huile Réf. CGN	Filtre air Réf. HiffoFiltro	Filtre air Réf. CGN
TX300I	300	20	-	-	HFF5019	502290
TX300I	300	21	-	-	HFF5019	502290
WR300	300	09 - 13	-	-	HFF6012	513490
TE310	310	09 - 10	HF563	502307	HFF6012	513490
TE310	310	11 - 14	HF116	508613	HFF6012	513490
TE310 R	310	13	HF116	508613	HFF6012	513490
TXC310 R	310	11 - 14	HF116	508613	HFF6012	513490
FC350	350	15	HF652	513015	HFF5018	513488
FC350	350	16 - 20	HF652	513015	HFF5019	502290
FC350	350	21	HF652	513015	HFF5019	502290
FE350	350	14 - 16	HF652	513015	HFF5018	513488
FE350	350	17 - 18	HF652	513015	HFF5019	502290
FE350	350	19 - 20	HF652	513015	HFF5019	502290
FE350	350	21	HF652	513015	HFF5019	502290
FE350 S	350	16	HF652	513015	HFF5018	513488
FE350 S	350	20	HF652	513015	HFF5019	502290
FE350 S	350	21	HF652	513015	HFF5019	502290
FX350	350	17 - 19	HF652	513015	HFF5019	502290
FX350	350	20	HF652	513015	HFF5019	502290
FX350	350	21	HF652	513015	HFF5019	502290
CR360	360	90 - 03	-	-	HFF6012	513490
WR360	360	90 - 03	-	-	HFF6012	513490
401 SVARTPILEN	401	18 - 19	HF155	512967	HFA6303	527101
401 SVARTPILEN	401	20	HF155	512967	HFA6303	527101
401 VITPILEN	401	18 - 19	HF155	512967	HFA6303	527101
401 VITPILEN	401	20	HF155	512967	HFA6303	527101
TE410 E	410	98	HF154	512966	-	-
TE410 E	410	99	HF154	512966	-	-
TE410 E	410	0	HF154	512966	-	-
TE410 E	410	1	HF154	512966	-	-
SMR449	449	11 - 12	HF611	513010	-	-
TC449	449	11 - 14	HF611	513010	-	-
TE449	449	11 - 14	HF611	513010	-	-
FC450	450	14 - 15	HF655	513016	HFF5018	513488
FC450	450	16 - 20	HF652	513015	HFF5019	502290
FC450	450	21	HF652	513015	HFF5019	502290
FC450 ROCKSTAR EDITION	450	18 - 20	HF652	513015	HFF5019	502290
FE450	450	14 - 16	HF655	513016	HFF5018	513488
FE450	450	17 - 18	HF652	513015	HFF5019	502290
FE450	450	19 - 20	HF652	513015	HFF5019	502290
FE450	450	21	HF652	513015	HFF5019	502290
FR450 RALLY	450	16 - 18	HF650	513013	-	-
FR450 RALLY	450	19 - 20	HF650	513013	-	-
FR450 RALLY	450	21	HF650	513013	-	-
FS450	450	16 - 20	HF652	513015	HFF5019	502290

Modèle	Cylindrée	Année	H.FLOFILTRO		H.FLOFILTRO	
			Filtre huile Réf. HilfoFiltro	Filtre huile Réf. CGN	Filtre air Réf. HilfoFiltro	Filtre air Réf. CGN
FS450	450	21	HF652	513015	HFF5019	502290
FX450	450	17 - 19	HF652	513015	HFF5019	502290
FX450	450	20	HF652	513015	HFF5019	502290
FX450	450	21	HF652	513015	HFF5019	502290
TC450	450	02 - 07	HF154	512966	HFF6012	513490
TC450	450	08 - 10	HF563	502307	HFF6012	513490
TE450	450	02 - 07	HF154	512966	HFF6012	513490
TE450	450	08 - 10	HF563	502307	HFF6012	513490
TXC450	450	08 - 11	HF563	502307	HFF6012	513490
SM450 R	450	04 - 07	HF154	512966	HFF6012	513490
SM450 R	450	08 - 10	HF563	502307	HFF6012	513490
SM450 RR	450	9	HF563	502307	HFF6012	513490
QM450 (ATV)	450	07 - 08	HF154	512966	-	-
FE501	501	14 - 16	HF655	513016	HFF5018	513488
FE501	501	17 - 19	HF652	513015	HFF5019	502290
FE501	501	20	HF652	513015	HFF5019	502290
FE501	501	21	HF652	513015	HFF5019	502290
FE501 S	501	15 - 16	HF655	513016	HFF5018	513488
FE501 S	501	20 - 21	HF652	513015	HFF5019	502290
TC510	510	05 - 07	HF154	512966	HFF6012	513490
TC510	510	08 - 10	HF563	502307	HFF6012	513490
TCX510	510	08 - 11	HF563	502307	HFF6012	513490
TE510	510	04 - 07	HF154	512966	HFF6012	513490
TE510	510	08 - 10	HF563	502307	HFF6012	513490
TXC510	510	08 - 09	HF563	502307	HFF6012	513490
SM510 R	510	05 - 07	HF154	512966	HFF6012	513490
SM510 R	510	08 - 10	HF563	502307	HFF6012	513490
SM530 RR	530	9	HF563	502307	HFF6012	513490
SMR511	511	11 - 12	HF611	513010	-	-
TE511	511	11 - 14	HF611	513010	-	-
TE610 E ENDURO	610	98 - 01	HF154	512966	-	-
TE610 E LT	610	0	HF154	512966	-	-
TE610 IE	610	06 - 08	HF154	512966	-	-
SM610	610	98 - 99	HF154	512966	-	-
SM610 S	610	00 - 01	HF154	512966	-	-
SM610 S IE	610	06 - 08	HF154	512966	-	-
SM630 IE	630	10	HF563	502307	-	-
SMR630	630	11	HF563	502307	-	-
SMS630	630	11	HF563	502307	-	-
TE630 IE	630	10	HF563	502307	-	-
TE630	630	11	HF563	502307	-	-
701 ENDURO 1ST OIL FILTER 2ND OIL FILTER	701	16 - 19	HF651	513014	-	-
701 ENDURO 1ST OIL FILTER 2ND OIL FILTER	701	20	HF651	513014	-	-

Modèle	Cylindrée	Année	HIFLOFILTRO		HIFLOFILTRO	
			Filtre huile Réf. HifloFiltro	Filtre huile Réf. CGN	Filtre air Réf. HifloFiltro	Filtre air Réf. CGN
701 SUPERMOTO 1ST OIL FILTER 2ND OIL FILTER	701	16 - 19	HF651	513014	-	-
701 SUPERMOTO 1ST OIL FILTER 2ND OIL FILTER	701	20	HF651	513014	-	-
701 SVARTPILEN 1ST OIL FILTER 2ND OIL FILTER	701	19 - 20	HF651	513014	-	-
701 VITPILEN 1ST OIL FILTER 2ND OIL FILTER	701	18 - 19	HF651	513014	-	-
701 VITPILEN 1ST OIL FILTER 2ND OIL FILTER	701	20	HF651	513014	-	-
900 NUDA	900	11 - 14	HF160	512971	-	-
900 NUDA R	900	11 - 14	HF160	512971	-	-
HYOSUNG						
125 EXCEED	125	5	HF131	502305	-	-
GA125 CRUISE I, II	125	97 - 01	HF131	502305	-	-
GF125	125	98 - 03	HF131	502305	-	-
GT125 COMET	125	03 - 15	HF131	502305	-	-
GT125 R COMET	125	09 - 15	HF131	502305	-	-
GV125 AQUILA	125	00 - 08	HF131	502305	-	-
GV125 C AQUILA	125	09 - 15	HF131	502305	-	-
MS3 125	125	06 - 11	HF197	503794	-	-
RT125 KARION	125	04 - 15	HF131	502305	-	-
RX125 D / SM	125	07 - 11	HF131	502305	-	-
XR125	125	00 - 08	HF131	502305	-	-
GD250 N	250	17 -	HF197	503794	-	-
GD250 R	250	17 -	HF197	503794	-	-
GT250 COMET	250	04 - 08	HF131	502305	-	-
GT250 COMET EFI	250	09 - 15	HF131	502305	-	-
GT250 R COMET EFI	250	09 - 15	HF131	502305	-	-
GV250 AQUILA	250	01 - 08	HF131	502305	-	-
GV250 AQUILA EFI	250	09 - 15	HF131	502305	-	-
MS3 250	250	06 - 11	HF197	503794	-	-
GT650 COMET	650	05 - 08	HF681	502309	-	-
GT650 COMET EFI	650	09 - 15	HF681	502309	-	-
GT650 R COMET EFI	650	09 - 15	HF681	502309	-	-
GT650 S COMET EFI	650	10 - 15	HF681	502309	-	-
GT650 NAKED	650	04 - 06	HF681	502309	-	-
GT650 NAKED SE I	650	07 - 08	HF681	502309	-	-
GT650 S SPORT	650	05 - 08	HF681	502309	-	-
GT650 R SPORTTOURING	650	05 - 08	HF681	502309	-	-
GT650 R SPORT FI	650	07 - 08	HF681	502309	-	-
GV650 AQUILA	650	05 - 08	HF681	502309	-	-
GV650 AQUILA EFI	650	09 - 15	HF681	502309	-	-
GV650 AVITAR EFI	650	10 - 15	HF681	502309	-	-
GV650 SE EFI	650	10 - 11	HF681	502309	-	-
ST7	678	10 - 15	HF681	502309	-	-

Modèle	Cylindrée	Année	H.FLOFILTRO		H.FLOFILTRO	
			Filtre huile Réf. HilfoFiltro	Filtre huile Réf. CGN	Filtre air Réf. HilfoFiltro	Filtre air Réf. CGN
GV700 C EFI	678	10 - 11	HF681	502309	-	-
TE450 (ATV)	450	08 - 11	HF682	513018	-	-
INDIAN						
SCOUT	1130	15 - 19	HF199	512991	-	-
SCOUT, ABS / ANNIVERSARY	1130	20 - 21	HF199	512991	-	-
SCOUT SIXTY	1130	17 - 19	HF199	512991	-	-
KAWASAKI						
ZRX1200	1200	01 - 03	HF401	512994	HFA2910	513229
ZRX1200 R (ZRI200 A1-A6)	1200	01 - 06	HF401	512994	HFA2910	513229
ZRX1200 S (ZRI200S B1-B4)	1200	01 - 04	HF401	512994	HFA2910	513229
ZZ-R1200 C1-C4 (ZX1200)	1200	02 - 05	HF401	512994	HFA2909	513228
ZX-14 A6F, A7F, C8F, C9F, CAF, CAFA, CBF NINJA (ZX1400)	1400	06 - 11	HF303	493942	HFA2916	513235
ZX-14 ECF, EDF, EEFA, FEFA, FFFA, FFFB, HGF, JGF NINJA (ZX1400)	1400	12 - 16	HF303	493942	HFA2923	-
ZX-14 HHF, HJF, HKF, HLF NINJA (ZX1400)	1400	17 - 20	HF303	493942	HFA2923	-
ZX-14 JHF, JJF, JFK, JLF NINJA (ZX1400) SE	1400	17 - 20	HF303	493942	HFA2923	-
ZZR1400 B6F, B7F, D8F, D9F, DAF, DBF (ZX1400)	1400	06 - 11	HF303	493942	HFA2916	513235
ZZR1400 DCF, FCF, , FDF, FEF, FFF, HJF, HLF, JJF, JFK, JLF (ZX1400)	1400	12 - 20	HF303	493942	HFA2923	-
ZZR1400 (ZX1400) SPECIAL EDITION	1400	13	HF303	493942	HFA2923	-
ZZR1400 PERFORMANCE	1400	11 - 13	HF303	493942	HFA2916	513235
ZZR1400 PERFORMANCE SPORT	1400	13 - 20	HF303	493942	HFA2923	-
ZG1400 A8F, A9F, CAF, CBF, CCF, CDF, CEF, EFF, EGF, EHF, EJF, EKf, ELF CONCOURS ABS (GTRI400)	1400	08 - 20	HF303	493942	HFA2916	513235
ZG1400 B8F, B9F, DAF CONCOURS (GTRI400)	1400	08 - 10	HF303	493942	HFA2916	513235
VNI500 B1-B6 VULCAN SE	1500	87 - 93	HF303	493942	HFA2709	513219
VNI500 A1-A9 VULCAN	1500	87 - 95	HF303	493942	HFA2709	513219
VNI500 D1, D2, E1 CLASSIC	1500	96 - 98	HF303	493942	HFA2911	513230
VNI500 E2-E7 CLASSIC	1500	99 - 04	HF204	487431	HFA2911	513230
VNI500 N4, N6F, T6F CLASSIC	1500	05 - 06	HF204	487431	HFA2911	513230
VNI500 N7F, N8F CLASSIC	1500	07 - 08	HF303	493942	HFA2911	513230
VNI500 N1, N2 CLASSIC FI	1500	00 - 01	HF204	487431	HFA2911	513230
VNI500 N3H CLASSIC FI	1500	2	HF204	487431	HFA2911	513230
VNI500 G1 CLASSIC TOURER	1500	98	HF303	493942	HFA2911	513230
VNI500 G1, G2, G3 NOMAD	1500	99 - 01	HF204	487431	HFA2911	513230
VNI500 L1 NOMAD FI	1500	0	HF303	493942	HFA2911	513230
VNI500 L2 NOMAD FI	1500	1	HF204	487431	HFA2911	513230
VNI500 L3-L5 NOMAD FI	1500	02 - 04	HF204	487431	HFA2911	513230
VNI500 L1H CLASSIC TOURER FI	1500	99 - 00	HF303	493942	HFA2911	513230
VNI500 L2H, L3H, L4H CLASSIC TOURER FI	1500	01 - 03	HF204	487431	HFA2911	513230
VNI500 J1, J2 DRIFTER	1500	99 - 00	HF204	487431	HFA2911	513230
VNI500 R1-R5 DRIFTER	1500	01 - 05	HF204	487431	HFA2911	513230

Modèle	Cylindrée	Année	HIFLOFILTRO		HIFLOFILTRO	
			Filtre huile Réf. HifloFiltro	Filtre huile Réf. CGN	Filtre air Réf. HifloFiltro	Filtre air Réf. CGN
VNI500 P1-P2 MEAN STREAK	1500	02 - 03	HF204	487431	HFA2911	513230
VNI600 B1-B2, B6F, F6F MEAN STREAK	1600	04 - 06	HF204	487431	HFA2911	513230
VNI600 B7F, B8F MEAN STREAK	1600	07 - 08	HF303	493942	HFA2911	513230
VNI700 JBF, JBFA, JCF, JCFA, JDF, JDFA, KEF, KEFA, KFF, KGF, KHf, KJF, KKF, KLF VULCAN VOYAGER VAQUERO	1700	11 - 20	HF303	493942	-	-
VNI700 KBF VULCAN VOYAGER CUSTOM (ABS)	1700	11 - 14	HF303	493942	-	-
VN2000 A1-A2, A6F VULCAN	2000	04 - 06	HF204	487431	-	-
VN2000 A7F VULCAN	2000	7	HF303	493942	-	-
VN2000 G8F, G9F VULCAN	2000	08 - 09	HF303	493942	-	-
VN2000 D6F VULCAN LTD.	2000	6	HF204	487431	-	-
VN2000 E6F, E7F VULCAN CLASSIC	2000	06 - 07	HF303	493942	-	-
VN2000 H8F, H9F VULCAN CLASSIC	2000	08 - 09	HF303	493942	-	-
VN2000 F6F, F7F VULCAN CLASSIC LT	2000	06 - 07	HF204	487431	-	-
VN2000 J8F, J9F, JAF VULCAN CLASSIC LT	2000	08 - 10	HF303	493942	-	-
KLT200 A-A4, A4A, B1	200	80 - 83	HF123	512946	-	-
KLT200 C1, C2	200	83 - 84	HF123	512946	-	-
KLT250 A1, A2	250	82 - 83	HF123	512946	-	-
KLT250 C1, C2, C3 PRAIRIE	250	83 - 85	HF123	512946	-	-
KLT250 PI POLICE	250	84	HF123	512946	-	-
KLF220 A1-A15 BAYOU	220	88 - 02	HF123	512946	HFF2029	513448
KLF250 A1-A3, A6F, A7F, A8F, A9F, AAF, ABF BAYOU	250	03 - 11	HF123	512946	HFF2029	513448
KFX400 A1-A3, A6F (KSF400)	400	03 - 06	HF139	512957	HFF2025	-
KFX450R B8F, B9F, BAF, BBF, BCS, BDF, BEF (KSF450)	450	08 - 14	HF112	512944	HFF2026	513445
KFX450R B8FA, B9FB (KSF450) MONSTER ENERGY	450	08 - 09	HF112	512944	HFF2026	513445
KVF650 A1-A2, B1-B2 PRAIRIE	650	02 - 03	HF204	487431	HFF2028	513447
KVF650 D1, D6F-D9F, DAF-DDF BRUTE FORCE 4 X 4	650	05 - 13	HF204	487431	HFF2028	513447
KVF650 E1, E6F-E9F BRUTE FORCE 4 X 4 REALTREE HARD. GREEN HD	650	05 - 09	HF204	487431	HFF2028	513447
KVF650 F6F-F9F, FAF-FEF BRUTE FORCE 4 X 4I	650	06 - 15	HF204	487431	HFF2028	513447
KVF650 G6F-G9F BRUTE FORCE 4 X 4I REALTREE HARD. GREEN HD	650	06 - 09	HF204	487431	HFF2028	513447
KVF650 H7F, H8F BRUTE FORCE 4 X 4I	650	07 - 08	HF204	487431	HFF2028	513447
KFX700 A1-A2, B2 V FORCE (KSV700)	700	04 - 05	HF204	487431	HFF2028	513447
KFX700 A6F, A7F, A8F, A9F, B6F, B7F, B8F, B9F, C6F (KSV700)	700	06 - 09	HF204	487431	HFF2028	513447
KVF700 A1-A2, A6F PRAIRIE 4X4	700	04 - 06	HF204	487431	HFF2028	513447
KVF700 B1-B2 PRAIRIE 4X4 HARDWOODS GREEN HD	700	04 - 05	HF204	487431	HFF2028	513447
KVF700 D1, D6F TEAM GREEN SPECIAL EDITION	700	05 - 06	HF204	487431	HFF2028	513447
KVF750 A1 BRUTE FORCE 4X4I	750	5	HF204	487431	HFF2028	513447

Modèle	Cylindrée	Année	H.FLOFILTRO		H.FLOFILTRO	
			Filtre huile Réf. HilfoFiltro	Filtre huile Réf. CGN	Filtre air Réf. HilfoFiltro	Filtre air Réf. CGN
KVF750 A1 BRUTE FORCE 4X4I REALTREE HARDWOODS GREEN HD	750	5	HF204	487431	HFF2028	513447
KVF750 A6F, A7F, B6F, B7F, C6F, C7F BRUTE FORCE 4X4I	750	06 - 07	HF204	487431	HFF2028	513447
KVF750 D8F, D9F, DAF, DBF BRUTE FORCE 4X4I	750	08 - 11	HF204	487431	HFF2028	513447
KVF750 LCF, LCS, LDF, LEF, LFF, LGF, LHF, LJF, LKF, LLF BRUTE FORCE 4X4I	750	12 - 20	HF204	487431	HFF2028	513447
KVF750 LMF BRUTE FORCE 4X4I	750	21	HF204	487431	HFF2028	513447
KVF750 D8FA, D9FA BRUTE FORCE 4X4I NRA OUTDOORS	750	08 - 09	HF204	487431	HFF2028	513447
KVF750 E8F, E9F, EAF BRUTE FORCE 4X4I REALTREE HARDWOODS GREEN HD	750	08 - 10	HF204	487431	HFF2028	513447
KVF750 E8FA, E9FA BRUTE FORCE 4X4I NRA OUTDOORS	750	08 - 09	HF204	487431	HFF2028	513447
KVF750 F8F, F9F, FAF, FBF BRUTE FORCE 4X4I NRA OUTDOORS	750	08 - 11	HF204	487431	HFF2028	513447
KVF750 GCF-GEF, HCF-HEF, JCF-JEF BRUTE FORCE 4X4I EPS	750	12 - 14	HF204	487431	HFF2028	513447
KVF750 GFF-GLF, HFF-HLF, JFF-JLF BRUTE FORCE 4X4I EPS	750	15 - 20	HF204	487431	HFF2028	513447
KVF750 GMF, HMF, JMF BRUTE FORCE 4X4I EPS	750	21	HF204	487431	HFF2028	513447
KAF620 MMF, RMF, SMF MULE 4010 TRANS 4X4	620	21	HF128	512950	-	-
KAF620 S9F MULE 4010 TRANS 4X4 HARDWOODS GREEN HD	620		HF128	512950	-	-
KAF620 SAF, SBF MULE 4010 TRANS 4X4 REALTREE APG HD 49065-2071	620		HF128	512950	-	-
KAF620 SEF-SLF MULE 4010 TRANS 4X4 CAMO	620		HF128	512950	-	-
KAF620 TGF-TJF MULE 4010 4X4 SE	620		HF128	512950	-	-
KAF620 VGF-VLF MULE 4010 TRANS 4X4 CAMO SE	620		HF128	512950	-	-
KAF820 KKF-KLF MULE PRO-FXR	820	19 - 20	HF129	512951	-	-
KAF820 KMFNN MULE PRO-FXR	820	21	HF129	512951	-	-
KAF820 MULE PRO-FXT RANCH EDITION	820	16	HF129	512951	-	-
KAF820MMFNN MULE PRO-FXT RANCH EDITION	820	21	HF129	512951	-	-
KAF950 A1-A3 MULE 2510 DIESEL 4X4	950	00 - 03	HF129	512951	-	-
KAF950 B1-B3, B6F, B7F, D8F MULE 3010 DIESEL 4X4	950	04 - 08	HF129	512951	-	-
KAF950 C7F, E8F, F9F, FAF, FBF MULE 3010 TRANS 4X4 DIESEL	950	07 - 11	HF129	512951	-	-
KAF950 F9F, FAF, FBF, FCF, FDF, FEF MULE 4010 DIESEL 4X4	950	09 - 15	HF129	512951	-	-
KAF950 G9F, GAF, GBF, GCF, GDF, GEF MULE 4010 TRANS 4X4 DIESEL	950	09 - 15	HF129	512951	-	-
KAF950 HAF MULE 4010 TRANS 4X4 DIESEL REALTREE APG HD	950	10	HF129	512951	-	-
KRF1000ALF, AMFNN TERYX KRX 1000	1000	20 - 21	HF204	487431	-	-
KRF1000BMFNN TERYX KRX 1000 TRAIL EDITION	1000	21	HF204	487431	-	-

Modèle	Cylindrée	Année	HIFLOFILTRO		HIFLOFILTRO	
			Filtre huile Réf. HifloFiltro	Filtre huile Réf. CGN	Filtre air Réf. HifloFiltro	Filtre air Réf. CGN
KRF1000CMFNN TERYX KRX 1000 SPECIAL EDITION	1000	21	HF204	487431	-	-
KTM						
125 DUKE	125	11 - 16	HF155	512967	HFA6302	502283
125 DUKE	125	17 - 19	HF155	512967	HFA6303	527101
125 DUKE	125	20	HF155	512967	HFA6303	527101
125 DUKE	125	21	HF155	512967	HFA6303	527101
125 RC	125	14 - 19	HF155	512967	HFA6302	502283
125 RC	125	20	HF155	512967	HFA6302	502283
200 DUKE	200	12 - 19	HF155	512967	HFA6302	502283
200 DUKE	200	20	HF155	512967	HFA6303	527101
200 DUKE	200	21	HF155	512967	HFA6303	527101
200 RC	200	14 - 18	HF155	512967	HFA6302	502283
200 RC	200	19	HF155	512967	HFA6302	502283
200 RC	200	20	HF155	512967	HFA6302	502283
250 EXC RACING 1ST OIL FILTER 2ND OIL FILTER	250	3	HF155	512967	HFF5012	513482
250 EXC RACING 1ST OIL FILTER 2ND OIL FILTER	250	04 - 06	HF155	512967	HFF5013	513483
250 DUKE	250	15 - 16	HF155	512967	HFA6302	502283
250 DUKE	250	17 - 19	HF155	512967	HFA6303	527101
250 DUKE	250	20	HF155	512967	HFA6303	527101
250 EXC-F	250	7	HF655	513016	HFF5013	513483
250 EXC-F	250	08 - 11	HF655	513016	HFF5016	513486
250 EXC-F	250	12	HF655	513016	HFF5018	513488
250 EXC-F	250	13 - 16	HF652	513015	HFF5018	513488
250 EXC-F	250	17 - 20	HF652	513015	HFF5019	502290
250 EXC-F	250	21	HF652	513015	HFF5019	502290
250 EXC-F CKD	250	18 - 20	HF652	513015	HFF5019	502290
250 EXC-F SIX DAYS	250	12	HF655	513016	HFF5018	513488
250 EXC-F SIX DAYS	250	13 - 16	HF652	513015	HFF5018	513488
250 EXC-F SIX DAYS	250	17 - 20	HF652	513015	HFF5019	502290
250 EXC-F SIX DAYS	250	21	HF652	513015	HFF5019	502290
250 RC	250	15 - 17	HF155	512967	HFA6302	502283
250 RC4R	250	20	HF652	513015	HFF5019	502290
250 SX	250	17 - 21	-	-	HFF5019	502290
250 SX-F	250	05 - 07	HF655	513016	HFF5013	513483
250 SX-F	250	08 - 10	HF655	513016	HFF5016	513486
250 SX-F	250	11 - 12	HF655	513016	HFF5018	513488
250 SX-F	250	13 - 15	HF652	513015	HFF5018	513488
250 SX-F	250	16 - 20	HF652	513015	HFF5019	502290
250 SX-F	250	21	HF652	513015	HFF5019	502290
250 XC-F / XCF-W	250	7	HF655	513016	HFF5013	513483
250 XC-F / XCF-W	250	8	HF655	513016	HFF5016	513486
250 XC-F / XCF-W	250	09 - 10	HF655	513016	HFF5016	513486
250 XC-F / XCF-W	250	11 - 12	HF655	513016	HFF5018	513488

Modèle	Cylindrée	Année	H.FLOFILTRO		H.FLOFILTRO	
			Filtre huile Réf. HilfoFiltro	Filtre huile Réf. CGN	Filtre air Réf. HilfoFiltro	Filtre air Réf. CGN
250 XC-F / XCF-W	250	13 - 15	HF652	513015	HFF5018	513488
250 XC-F	250	16 - 20	HF652	513015	HFF5019	502290
250 XC-F	250	21	HF652	513015	HFF5019	502290
250 XCF-W SIX DAYS (USA)	250	11	HF655	513016	HFF5016	513486
300 EXC-F	300	15	HF652	513015	HFF5018	513488
300 XC	300	17 - 19	-	-	HFF5019	502290
300 XC TPI	300	20 - 21	-	-	HFF5019	502290
300 XC-W	300	11	-	-	HFF5016	513486
300 XC-W	300	12 - 16	-	-	HFF5018	513488
300 XC-W	300	17 - 18	-	-	HFF5019	502290
300 XC-W TPI	300	19 - 20	-	-	HFF5019	502290
300 XC-W TPI	300	21	-	-	HFF5019	502290
300 XC-W TPI ERZBERG RODEO	300	21	-	-	HFF5019	502290
300 XC-W SIX DAYS	300	16	-	-	HFF5018	513488
300 XC-W SIX DAYS	300	17 - 20	-	-	HFF5019	502290
350 LC-4	350	93 - 99	-	-	HFF5011	513481
350 EXC-F	350	12 - 16	HF652	513015	HFF5018	513488
350 EXC-F	350	17 - 20	HF652	513015	HFF5019	502290
350 EXC-F	350	21	HF652	513015	HFF5019	502290
350 EXC-F SIX DAYS	350	12 - 15	HF652	513015	HFF5018	513488
350 EXC-F SIX DAYS	350	17 - 20	HF652	513015	HFF5019	502290
350 EXC-F SIX DAYS	350	21	HF652	513015	HFF5019	502290
350 EXC-F SIX DAYS CKD	350	18 - 20	HF652	513015	HFF5019	502290
350 EXC-F SIX DAYS CKD	350	21	HF652	513015	HFF5019	502290
350 SX-F	350	11 - 15	HF652	513015	HFF5018	513488
350 SX-F	350	16 - 20	HF652	513015	HFF5019	502290
350 SX-F	350	21	HF652	513015	HFF5019	502290
350 XC-F	350	12 - 13	HF652	513015	HFF5018	513488
350 XC-F	350	17 - 20	HF652	513015	HFF5019	502290
350 XC-F	350	21	HF652	513015	HFF5019	502290
350 XCF-W	350	12 - 16	HF652	513015	HFF5018	513488
350 XCF-W	350	20 - 21	HF652	513015	HFF5019	502290
350 XCF-W SIX DAYS	350	16	HF652	513015	HFF5018	513488
390 ADVENTURE	390	20	HF155	512967	HFA6303	527101
390 ADVENTURE	390	21	HF155	512967	HFA6303	527101
390 DUKE	390	13 - 16	HF155	512967	HFA6302	502283
390 DUKE	390	17 - 19	HF155	512967	HFA6303	527101
390 DUKE	390	20	HF155	512967	HFA6303	527101
390 DUKE	390	21	HF155	512967	HFA6303	527101
390 R2R	390	20	HF155	512967	HFA6303	527101
390 RC	390	14 - 17	HF155	512967	HFA6302	502283
390 RC	390	17 - 18	HF155	512967	HFA6302	502283
390 RC	390	19	HF155	512967	HFA6302	502283
390 RC	390	20	HF155	512967	HFA6302	502283

MOTEUR

CYCLE

PNEUMATIQUE

ATELIER

ACCESSOIRES

ÉLECTRICITÉ

FILTRATION

FREINAGE

TRANSMISSION

Modèle	Cylindrée	Année	HIFLOFILTRO		HIFLOFILTRO	
			Filtre huile Réf. HiffoFiltro	Filtre huile Réf. CGN	Filtre air Réf. HiffoFiltro	Filtre air Réf. CGN
390 RC R	390	18	HF155	512967	HFA6302	502283
400 EXC RACING (1 HOLE AIR FILTER) 1ST OIL FILTER 2ND OIL FILTER	400	04 - 05	HF155	512967	HFF5012	513482
400 EXC RACING (3 HOLE AIR FILTER) 1ST OIL FILTER 2ND OIL FILTER	400	04 - 05	HF155	512967	HFF5013	513483
400 EXC 1ST OIL FILTER 2ND OIL FILTER	400	06 - 07	HF155	512967	HFF5013	513483
400 EXC	400	08 - 11	HF652	513015	HFF5016	513486
400 SX / MXC / EXC (1 HOLE AIR FILTER) 1ST OIL FILTER 2ND OIL FILTER	400	04 - 05	HF155	512967	HFF5012	513482
400 SX / MXC / EXC (3 HOLE AIR FILTER) 1ST OIL FILTER 2ND OIL FILTER	400	04 - 05	HF155	512967	HFF5013	513483
400 XC-W 1ST OIL FILTER 2ND OIL FILTER	400	7	HF155	512967	HFF5013	513483
400 XC-W	400	08 - 10	HF652	513015	HFF5016	513486
450 SX / EXC / MXC 1ST OIL FILTER 2ND OIL FILTER	450	03 - 06	HF155	512967	HFF5013	513483
450 EXC 1ST OIL FILTER 2ND OIL FILTER	450	7	HF155	512967	HFF5013	513483
450 EXC-R	450	8	HF652	513015	HFF5016	513486
450 EXC	450	09 - 11	HF652	513015	HFF5016	513486
450 EXC	450	12 - 16	HF655	513016	HFF5018	513488
450 EXC SIX DAYS	450	10 - 11	HF652	513015	HFF5016	513486
450 EXC SIX DAYS	450	12 - 16	HF655	513016	HFF5018	513488
450 EXC-F	450	17 - 19	HF652	513015	HFF5019	502290
450 EXC-F	450	20 - 21	HF652	513015	HFF5019	502290
450 EXC-F SIX DAYS	450	17 - 20	HF652	513015	HFF5019	502290
450 EXC-F SIX DAYS	450	21	HF652	513015	HFF5019	502290
450 SMR 1ST OIL FILTER 2ND OIL FILTER	450	05 - 07	HF155	512967	HFF5013	513483
450 SMR	450	11 - 12	HF652	513015	HFF5018	513488
450 SMR	450	13 - 14	HF655	513016	HFF5018	513488
450 SMR	450	21	HF652	513015	HFF5019	502290
450 SX-F	450	07 - 10	HF652	513015	HFF5016	513486
450 SX-F	450	11 - 12	HF652	513015	HFF5018	513488
450 SX-F	450	13 - 15	HF655	513016	HFF5018	513488
450 SX-F	450	16 - 20	HF652	513015	HFF5019	502290
450 SX-F	450	21	HF652	513015	HFF5019	502290
450 SX-F FACTORY EDITION	450	21	HF652	513015	HFF5019	502290
450 XC / XC-W 1ST OIL FILTER 2ND OIL FILTER	450	7	HF155	512967	HFF5013	513483
450 XC 1ST OIL FILTER 2ND OIL FILTER	450	8	HF155	512967	HFF5016	513486
450 XC-F / XC-WR	450	08 - 10	HF652	513015	HFF5016	513486
450 XC-F	450	13 - 15	HF655	513016	HFF5018	513488
450 XC-F	450	16 - 20	HF652	513015	HFF5019	502290
450 XC-F	450	21	HF652	513015	HFF5019	502290
450 XC-W	450	10 - 11	HF652	513015	HFF5016	513486
450 XC-W	450	12 - 16	HF655	513016	HFF5018	513488
450 XC-W SIX DAYS	450	10 - 11	HF652	513015	HFF5016	513486
500 EXC	500	12 - 16	HF655	513016	HFF5018	513488
500 EXC SIX DAYS	500	12 - 16	HF655	513016	HFF5018	513488

Modèle	Cylindrée	Année	H.FLOFILTRO		H.FLOFILTRO	
			Filtre huile Réf. HilfoFiltro	Filtre huile Réf. CGN	Filtre air Réf. HilfoFiltro	Filtre air Réf. CGN
500 EXC-F	500	17 - 19	HF652	513015	HFF5019	502290
500 EXC-F	500	20 - 21	HF652	513015	HFF5019	502290
500 EXC-F SIX DAYS	500	17 - 20	HF652	513015	HFF5019	502290
500 EXC-F SIX DAYS	500	21	HF652	513015	HFF5019	502290
500 XCF-W	500	20 - 21	HF652	513015	HFF5019	502290
500 XC-W	500	12 - 16	HF655	513016	HFF5018	513488
505 SX-F	450	08 - 09	HF652	513015	HFF5016	513486
505 XC-F	450	08 - 09	HF652	513015	HFF5016	513486
520 SX / MXC / EXC 1ST OIL FILTER 2ND OIL FILTER	520	99	HF155	512967		
520 SX / MXC / EXC 1ST OIL FILTER 2ND OIL FILTER	520	0	HF155	512967	HFF5012	513482
520 SX / MXC / EXC (1 HOLE AIR FILTER) 1ST OIL FILTER 2ND OIL FILTER	520	01 - 02	HF155	512967	HFF5012	513482
520 SX / MXC / EXC (3 HOLE AIR FILTER) 1ST OIL FILTER 2ND OIL FILTER	520	01 - 02	HF155	512967	HFF5013	513483
525 SX / MXC / EXC (1 HOLE AIR FILTER) 1ST OIL FILTER	525	3	HF155	512967	HFF5012	513482
525 SX / MXC / EXC (1 HOLE AIR FLTER) 2ND OIL FILTER	525	3	HF157	512969	-	-
525 SX / MXC / EXC / XC / XC-W (3 HOLE AIR FILTER) 1ST OIL FILTER 2ND OIL FILTER	525	03 - 07	HF155	512967	HFF5013	513483
525 SMR 1ST OIL FILTER 2ND OIL FILTER	525	04 - 06	HF155	512967	HFF5013	513483
530 EXC-R	530	08 - 09	HF652	513015	HFF5016	513486
530 EXC	530	10 - 11	HF652	513015	HFF5016	513486
530 EXC FACTORY EDITION	530	10	HF652	513015	HFF5016	513486
530 EXC SIX DAYS	530	09 - 11	HF652	513015	HFF5016	513486
530 XC-RW	530	08 - 09	HF652	513015	HFF5016	513486
530 XC-W	530	10	HF652	513015	HFF5016	513486
530 XC-W SIX DAYS	530	10 - 11	HF652	513015	HFF5016	513486
540 SXS 1ST OIL FILTER 2ND OIL FILTER	540		HF155	512967		
560 SMR 1ST OIL FILTER 2ND OIL FILTER	560	7	HF155	512967	HFF5013	513483
600 LC-4	600	93 - 99	-	-	HFF5011	513481
620 EXE 1ST OIL FILTER	620		HF155	512967	-	-
620 EXE SUPER COMPETITION 1ST OIL FILTER	620		HF155	512967	-	-
620 EGS 1ST OIL FILTER 2ND OIL FILTER	620		HF155	512967	-	-
620 DUKE 1ST OIL FILTER 2ND OIL FILTER	620		HF155	512967	-	-
620 LSK 1ST OIL FILTER 2ND OIL FILTER	620		HF155	512967	-	-
620 LC-4	620	94 - 99	-	-	HFF5011	513481
620 LC-4 DUKE	620	97 - 06	-	-	HFF5014	513484
625 SXC 1ST OIL FILTER 2ND OIL FILTER	625	03 - 04	HF155	512967	-	-
625 SXC 1ST OIL FILTER 2ND OIL FILTER	625	5	HF155	512967	-	-
625 SMC 1ST OIL FILTER 2ND OIL FILTER	625	04 - 05	HF155	512967	-	-
640 DUKE 1ST OIL FILTER 2ND OIL FILTER	640	99 - 06	HF155	512967	HFF5014	513484
640 LC4 1ST OIL FILTER 2ND OIL FILTER	640		HF155	512967	-	-

Modèle	Cylindrée	Année	HIFLOFILTRO		HIFLOFILTRO	
			Filtre huile Réf. HifloFiltro	Filtre huile Réf. CGN	Filtre air Réf. HifloFiltro	Filtre air Réf. CGN
660 RALLY E FACTORY REPLICA 1ST OIL FILTER 2ND OIL FILTER GEARBOX FILTER	660	06 - 07	HF156	512968	-	-
660 SUPERMOTO 1ST OIL FILTER 2ND OIL FILTER	660	02 - 03	HF155	512967	-	-
660 SMC 1ST OIL FILTER 1ST OIL FILTER	660	04 - 05	HF155	512967	-	-
690 DUKE 1ST OIL FILTER 2ND OIL FILTER	690	08 - 11	HF155	512967	-	-
690 DUKE 1ST OIL FILTER 2ND OIL FILTER	690	12 - 19	HF651	513014	-	-
690 DUKE R 1ST OIL FILTER 2ND OIL FILTER	690	10 - 11	HF155	512967	-	-
690 DUKE R 1ST OIL FILTER 2ND OIL FILTER	690	12 - 17	HF651	513014	-	-
690 ENDURO 1ST OIL FILTER 2ND OIL FILTER	690	08 - 11	HF155	512967	-	-
690 ENDURO R 1ST OIL FILTER 2ND OIL FILTER	690	09 - 11	HF155	512967	-	-
690 ENDURO R 1ST OIL FILTER 2ND OIL FILTER	690	12 - 19	HF651	513014	-	-
690 ENDURO R 1ST OIL FILTER 2ND OIL FILTER	690	20	HF651	513014	-	-
690 ENDURO R 1ST OIL FILTER 2ND OIL FILTER	690	21	HF651	513014	-	-
690 RALLY FACTORY REPLICA 1ST OIL FILTER 2ND OIL FILTER	690	07 - 08	HF651	513014	-	-
690 RALLY FACTORY REPLICA 1ST OIL FILTER 2ND OIL FILTER	690	09 - 10	HF651	513014	HFF5017	513487
690 SMC 1ST OIL FILTER 2ND OIL FILTER	690	08 - 11	HF155	512967	-	-
690 SMC R 1ST OIL FILTER 2ND OIL FILTER	690	12 - 19	HF651	513014	-	-
690 SMC R 1ST OIL FILTER 2ND OIL FILTER	690	20	HF651	513014	-	-
690 SMC R 1ST OIL FILTER 2ND OIL FILTER	690	21	HF651	513014	-	-
690 SUPERMOTO R 1ST OIL FILTER 2ND OIL FILTER	690	7	HF155	512967	-	-
690 SUPERMOTO R 1ST OIL FILTER 2ND OIL FILTER	690	08 - 09	HF155	512967	-	-
790 ADVENTURE	790	19 - 20	HF650	513013	HFA6301	513393
790 ADVENTURE	790	21	HF650	513013	HFA6301	513393
790 ADVENTURE R	790	19 - 20	HF650	513013	HFA6301	513393
790 ADVENTURE R	790	21	HF650	513013	HFA6301	513393
790 ADVENTURE R RALLY	790	20	HF650	513013	HFA6301	513393
790 DUKE	790	18 - 20	HF650	513013	-	-
890 ADVENTURE	890	21	HF650	513013	HFA6301	513393
890 ADVENTURE R	890	21	HF650	513013	HFA6301	513393
890 ADVENTURE R RALLY	890	21	HF650	513013	HFA6301	513393
890 DUKE R	890	20	HF650	513013	-	-
890 DUKE	890	21	HF650	513013	-	-
890 DUKE R	890	21	HF650	513013	-	-
950 ADVENTURE	950	03 - 06	HF650	513013	-	-
950 ADVENTURE S	950	04 - 06	HF650	513013	-	-
950 SUPER ENDURO / SUPER ENDURO R	950	07 - 11	HF650	513013	-	-
950 SUPERMOTO / SUPERMOTO R	950	06 - 08	HF650	513013	-	-
990 ADVENTURE	990	07 - 13	HF650	513013	-	-

Modèle	Cylindrée	Année	H.FLOFILTRO		H.FLOFILTRO	
			Filtre huile Réf. HilfoFiltro	Filtre huile Réf. CGN	Filtre air Réf. HilfoFiltro	Filtre air Réf. CGN
990 ADVENTURE R	990	10 - 13	HF650	513013	-	-
990 ADVENTURE DAKAR EDITION	990	11	HF650	513013	-	-
990 SUPERDUKE	990	05 - 11	HF650	513013	-	-
990 SUPERDUKE R	990	08 - 13	HF650	513013	-	-
990 SM R	990	10 - 13	HF650	513013	-	-
990 SM T	990	10 - 13	HF650	513013	-	-
1050 ADVENTURE	1050	15 - 16	HF650	513013	HFA6301	513393
1090 ADVENTURE	1090	17 - 18	HF650	513013	HFA6301	513393
1090 ADVENTURE R	1090	17 - 19	HF650	513013	HFA6301	513393
1090 ADVENTURE L	1090	18	HF650	513013	HFA6301	513393
1190 RC8	1190	09 - 11	HF650	513013	-	-
1190 RC8 R	1190	10 - 15	HF650	513013	-	-
1190 RC8 R TRACK	1190	11 - 15	HF650	513013	-	-
1190 ADVENTURE	1190	13 - 16	HF650	513013	HFA6301	513393
1190 ADVENTURE R	1190	13 - 16	HF650	513013	HFA6301	513393
1290 SUPER ADVENTURE	1290	15 - 16	HF650	513013	HFA6301	513393
1290 SUPER ADVENTURE R	1290	17 - 19	HF650	513013	HFA6301	513393
1290 SUPER ADVENTURE R	1290	20	HF650	513013	HFA6301	513393
1290 SUPER ADVENTURE R TKC	1290	18 - 19	HF650	513013	HFA6301	513393
1290 SUPER ADVENTURE R TKC	1290	20	HF650	513013	HFA6301	513393
1290 SUPER ADVENTURE S	1290	17 - 19	HF650	513013	HFA6301	513393
1290 SUPER ADVENTURE S	1290	20	HF650	513013	HFA6301	513393
1290 SUPER ADVENTURE S	1290	21	HF650	513013	-	-
1290 SUPER ADVENTURE T	1290	17	HF650	513013	HFA6301	513393
1290 SUPER DUKE GT	1290	16 - 19	HF650	513013	HFA6301	513393
1290 SUPER DUKE GT	1290	20	HF650	513013	HFA6301	513393
1290 SUPER DUKE GT	1290	21	HF650	513013	HFA6301	513393
1290 SUPER DUKE R	1290	14 - 19	HF650	513013	HFA6301	513393
1290 SUPER DUKE R	1290	20	HF650	513013	-	-
1290 SUPER DUKE R	1290	21	HF650	513013	-	-
450 SX ATV	450	09 - 11	HF650	513013	HFF5016	513486
450 XC ATV 1ST OIL FILTER 2ND OIL FILTER	450	08 - 11	HF155	512967	HFF5016	513486
505 SX ATV	505	09 - 12	HF650	513013	HFF5016	513486
525 XC ATV 1ST OIL FILTER 2ND OIL FILTER	525	08 - 11	HF155	512967	HFF5016	513486
KYMCO						
125 AGILITY / FAT (12" WHEELS)	125	05 - 15	-	-	HFA5007	502271
125 AGILITY MMC / ONE (12" WHEELS)	125	08 - 14	-	-	HFA5007	502271
125 AGILITY RS (12" WHEELS)	125	09 - 14	-	-	HFA5007	502271
125 AGILITY CARRY (12" WHEELS)	125	09 - 16	-	-	HFA5007	502271
125 AGILITY CITY (16" WHEELS)	125	08 - 18	-	-	HFA5001	502265
125 AGILITY CITY R16 +PLUS (16" WHEELS)	125	13 - 18	-	-	HFA5001	502265
125 DINK I.E.	125	06 - 15	HF562	487432	HFA5003	502267
125 DJ S	125	11 - 12	-	-	HFA5007	502271

MOTEUR

CYCLE

PNEUMATIQUE

ATELIER

ACCESSOIRES

ÉLECTRICITÉ

FILTRATION

FREINAGE

TRANSMISSION

Modèle	Cylindrée	Année	HIFLOFILTRO		HIFLOFILTRO	
			Filtre huile Réf. HifloFiltro	Filtre huile Réf. CGN	Filtre air Réf. HifloFiltro	Filtre air Réf. CGN
125 DOWNTOWN I.E.	125	09 - 16	HF566	494377	HFA5004	502268
125 DOWNTOWN ABS EXCLUSIVE EURO 4	125		HF566	494377	HFA5013	503912
125 GRAND DINK	125	01 - 07	HF562	487432	HFA5003	502267
125 GRAND DINK	125	08 - 11	HF562	487432	HFA5003	502267
125 GRAND DINK S	125	08 - 11	HF562	487432	HFA5003	502267
125I G-DINK I.E.	125	12 - 16	HF562	487432	HFA5003	502267
125 K-XCT I.E.	125	12 - 16	HF566	494377	HFA5011	503914
125 MOVIE XL	125	01 - 05	-	-	HFA5002	502266
125 MOVIE XL	125	06 - 10	-	-	HFA5002	502266
125 PEOPLE	125	99 - 15	-	-	HFA5001	502265
125I PEOPLE GT I.E. / CBS	125	10 - 17	HF566	494377	HFA5012	503913
125 PEOPLE S	125	05 - 15	-	-	HFA5001	502265
125 PEOPLE S DD I.E.	125	07 - 15	-	-	HFA5001	502265
125I PEOPLE S ABS (EURO 4)	125	17 - 19	-	-	HFA5016	513356
125 PEOPLE ONE I.E. / DD	125	13 - 16	-	-	HFA5001	502265
125 SUPER DINK IE	125	9	HF566	494377	-	-
125 SUPER 8	125	08 - 14	-	-	HFA5001	502265
125 VENOX	125		HF562	487432	-	-
125I X-TOWN CBS	125	17	HF566	494377	HFA5004	502268
150 AGILITY CITY (16" WHEELS)	150	08 - 15	-	-	HFA5001	502265
150 AGILITY CITY R16 +PLUS (16" WHEELS)	150	13 - 15	-	-	HFA5001	502265
150 GRAND DINK	150	01 - 11	HF562	487432	HFA5003	502267
150 MOVIE XL	150	01 - 05	-	-	HFA5002	502266
150 MOVIE XL	150	06 - 10	-	-	HFA5002	502266
150 PEOPLE	150	99 - 15	-	-	HFA5001	502265
150 PEOPLE S	150	05 - 15	-	-	HFA5001	502265
150 PEOPLE S DD I.E.	150	07 - 15	-	-	HFA5001	502265
150I PEOPLE S (EURO 4)	150	17 - 19	-	-	HFA5016	513356
150 PEOPLE GT I.E.	150	10 - 15	HF566	494377	-	-
150 SUPER 8	150	10 - 14	-	-	HFA5001	502265
200 AGILITY I.E. (16" WHEELS)	200	10 - 16	-	-	HFA5001	502265
200 AGILITY I.E. +PLUS (16"/14" WHEELS)	200	14 - 16	-	-	HFA5001	502265
200 DINK I.E.	200	06 - 16	HF562	487432	HFA5003	502267
200I DOWNTOWN I.E. (ABS)	200	10 - 15	HF566	494377	HFA5004	502268
200I PEOPLE GT I.E.	200	10 - 16	HF566	494377	HFA5012	503913
200I PEOPLE S	200	05 - 12	-	-	HFA5001	502265
200I PEOPLE S DD I.E.	200	07 - 15	-	-	HFA5001	502265
200I YAGER GT	200	10	HF562	487432		
250 GRAND DINK	250	01 - 09	-	-	HFA5003	502267
250 PEOPLE LC / S / IE	250	03 - 09	-	-	HFA5006	502270
250 VENOX	250	02 - 11	HF561	513004		
250 XCITING	250	05 - 08	-	-	HFA5003	502267
300I DOWNTOWN I.E.	300	09 - 16	HF566	494377	HFA5013	503912
300I DOWNTOWN I.E. (ABS)	300	09 - 16	HF566	494377	HFA5013	503912
300I G-DINK	300	12 - 16	-	-	HFA5003	502267

Modèle	Cylindrée	Année	H.FLOFILTRO		H.FLOFILTRO	
			Filtre huile Réf. HifoFiltro	Filtre huile Réf. CGN	Filtre air Réf. HifoFiltro	Filtre air Réf. CGN
300I K-XCT I.E.	300	12 - 16	HF566	494377	HFA5011	503914
300 PEOPLE / S / IE	300	08 - 14	-	-	HFA5006	502270
300I PEOPLE GT I.E.	300	10 - 17	HF566	494377	HFA5012	503913
300 XCITING RI	300	08 - 15	-	-	HFA5003	502267
300 X-TOWN	300	17 - 18	-	-	HFA5015	513355
350I DOWNTOWN I.E. (ABS)	350	09 - 16	HF566	494377	HFA5013	503912
400I XCITING	400	12 - 17	HF568	502308	HFA5014	503915
500 XCITING EITHER OIL FILTER LISTED IS A SUITABLE REPLACEMENT	500	05 - 09	HF147	478087	HFA5005	502269
500 XCITING RI EITHER OIL FILTER LISTED IS A SUITABLE REPLACEMENT	500	10 - 16	HF147	478087	HFA5005	502269
AK 550	550	17	HF164	489951	-	-
700I MYROAD EITHER OIL FILTER LISTED IS A SUITABLE REPLACEMENT	700	11 - 16	HF147	478087	-	-
375 MXU / MAXXER	375	08 - 12	HF138	487429	-	-
400 MXU (ATV)	400	08 - 12	HF138	487429	-	-
450 MXU I / MAXXER I	450	11 - 15	HF138	487429	-	-
500 MXU / XL	500	06 - 15	HF147	478087	-	-
500 UXV 4X4	500	08 - 15	HF147	478087	-	-
550 MXU I.E.	550	11 - 12	HF147	478087	-	-
700 MXU I.E.	700	13	HF147	478087	-	-
LAVERDA						
125/150/200 PHOENIX	125	01 -			HFA5101	502272
LML						
125 STAR 4T	125	09 - 13	HF167	512975	-	-
125 STAR CVT 4T	125	12 - 15	HF167	512975	-	-
150 STAR CVT 4T	150	09 - 15	HF167	512975	-	-
200 STAR 4T	200	11 - 15	HF207	512993	-	-
MAICO						
ALL MAICO MODELS		98 - 02	-	-	HFF5011	513481
MALAGUTI						
125 CIAK	125	01 - 09	-	-	HFA5001	502265
125 MADISON 3 (PIAGGIO ENGINE)	125	06 - 11	HF183	494342	HFA5201	527098
150 CIAK	150	01 - 05	-	-	HFA5001	502265
180 R MADISON	180	01 - 02	HF183	494342	-	-
200 CIAK MASTER	200	06 - 09	-	-	HFA5001	502265
200 S MADISON / RST	200	02 - 03	HF183	494342	-	-
200 F12 PHANTOM MAX	200	04 - 05	HF183	494342	HFA5201	527098
250 MADISON S	250	93 - 03	-	-	HFA4204	513297
250 MADISON S / RS / RST3 / 3 IE	250	04 - 11	HF183	494342	HFA5201	527098
250 PASSWORD / I.E. (CRANKCASE AIR FILTER)	250	05 - 11	-	-	HFA4203	513296
250 F12 PHANTOM MAX	250	04 - 05	HF183	494342	-	-
500 SPIDER MAX / GT / RS	500	04 - 11	HF184	478088	-	-
MBK						
125 CITYCRUISER EITHER OIL FILTER LISTED IS A SUITABLE REPLACEMENT	125	07 - 11	HF141	494343	HFA4104	502253

Modèle	Cylindrée	Année	HIFLOFILTRO		HIFLOFILTRO	
			Filtre huile Réf. HiffoFiltro	Filtre huile Réf. CGN	Filtre air Réf. HiffoFiltro	Filtre air Réf. CGN
125 CITYLINER EITHER OIL FILTER LISTED IS A SUITABLE REPLACEMENT	125	07 - 15	HF141	494343	HFA4104	502253
125 SKYCRUISER EITHER OIL FILTER LISTED IS A SUITABLE REPLACEMENT	125	06 - 15	HF141	494343	HFA4104	502253
SHERCO						
SE 2.5I F	250	08 - 17	HF611	513010	-	-
250 SEF-R FACTORY / SIX DAYS	250	18 - 21	HF611	513010	-	-
SX 2.5I F	250	10	HF611	513010	-	-
SE 3.0I F	300	10 - 17	HF611	513010	-	-
300 SEF-R FACTORY / SIX DAYS	300	18 - 21	HF611	513010	-	-
SE 4.5I F	450	04 - 17	HF611	513010	-	-
450 SC-R	450	19	HF611	513010	-	-
450 SEF-R FACTORY / SIX DAYS	450	18 - 21	HF611	513010	-	-
SM 4.5I F	450	04 - 15	HF611	513010	-	-
500 SEF FACTORY	500	19 - 21	HF611	513010	-	-
SE 5.1I F	510	04 - 13	HF611	513010	-	-
SM 5.1I F	510	04 - 10	HF611	513010	-	-
SUZUKI						
AN125 EITHER OIL FILTER LISTED IS A SUITABLE REPLACEMENT	125	96 - 00	HF131	502305	HFA3101	513242
DR-Z125 K3-K9, L0-L6	125	03 - 16	HF132	500772	HFF3016	513453
DR-Z125 L K3-K9, L0-L9, M0	125	03 - 21	HF132	500772	HFF3016	513453
GNI125 E-M, N, P, R, S, T, V	125	91 - 00	HF131	502305	HFA3105	513245
GSX-R125 L7, L8	125	17 - 18	HF131	502305	HFA3106	513246
GSX-R125 XA-L9	125	19	HF131	502305	HFA3106	513246
GSX-R125 M0	125	20	HF131	502305	HFA3106	513246
GSX-R125 M1	125	21	HF131	502305	HFA3106	513246
GSX-R125 RX-L7, L8 GP	125	17 - 18	HF131	502305	HFA3106	513246
GSX-S125 L7, L8	125	17 - 18	HF131	502305	HFA3106	513246
GSX-S125 XA-L9	125	19	HF131	502305	HFA3106	513246
GSX-S125 M0	125	20	HF131	502305	HFA3106	513246
GZ125 MARAUDER	125	99 - 10	HF131	502305	HFA3102	513243
TU125 XT	125	99	HF131	502305	HFA3105	513245
UH125 BURGMAN EITHER OIL FILTER LISTED IS A SUITABLE REPLACEMENT	125	07 - 12	HF131	502305	HFA3103	502246
UH125 BURGMAN EITHER OIL FILTER LISTED IS A SUITABLE REPLACEMENT	125	13 - 18	HF131	502305	HFA3103	502246
UH125 L9, M0 BURGMAN ABS EITHER OIL FILTER LISTED IS A SUITABLE REPLACEMENT	125	19 - 20	HF131	502305	HFA3103	502246
UX125 K8, K9, L0, L1-L5 SIXTEEN EITHER OIL FILTER LISTED IS A SUITABLE REPLACEMENT	125	08 - 15	HF131	502305	HFA3104	513244
UH200 K7, K8, K9, L0, L1, L2 BURGMAN EITHER OIL FILTER LISTED IS A SUITABLE REPLACEMENT	200	07 - 12	HF131	502305	HFA3103	502246
UH200 L3, L4, L5, L6, L7, L8, L9 BURGMAN EITHER OIL FILTER LISTED IS A SUITABLE REPLACEMENT	200	13 - 19	HF131	502305	HFA3103	502246

Modèle	Cylindrée	Année	H.FLOFILTRO		H.FLOFILTRO	
			Filtre huile Réf. HilfoFiltro	Filtre huile Réf. CGN	Filtre air Réf. HilfoFiltro	Filtre air Réf. CGN
DR250 L, M, N, P OFF ROAD	250	90 - 93	HF136	512955	HFF3020	513457
DR250 S-L, M, N, P, ER, ES, ET	250	90 - 96	HF136	512955	HFF3020	513457
DR250 SE-P, R, S, T, V OFF ROAD	250	93 - 99	HF136	512955	HFF3020	513457
DR-Z250 K1, K2, K3, K4, K5, K6, K7	250	01 - 07	HF136	512955	HFF3017	513454
DL250 A-L8 V-STROM	250	18	HF138	487429	HFA3202	-
DL250 A- V-STROM	250	19	HF138	487429	HFA3202	-
DL250 A- MO V-STROM	250	20	HF138	487429	HFA3202	-
GN250 SZ, EZ, D, F, J, M, N, P, R, S, T, V NJ42A	250	82 - 00	HF136	512955	HFA3105	513245
GSX250 R/RA-L7, L8	250	17 - 18	HF138	487429	HFA3202	-
GSX250 R-L9	250	19	HF138	487429	HFA3202	-
GSX250 R	250	20	HF138	487429	HFA3202	-
GSX250 R GP	250	20	HF138	487429	HFA3202	-
GW250 INAZUMA F / Z	250	12 - 18	HF138	487429	HFA3202	-
RM-Z250 K4, K5, K6	250	04 - 06	HF207	512993	HFF2015	513435
RM-Z250 K7, K8, K9, L0, L1, L2, L3, L4, L5, L6, L7, L8	250	07 - 18	HF207	512993	HFF3014	513451
RM-Z250 L9, MO	250	19 - 20	HF207	512993	HFF3026	513463
RM-Z250 M1	250	21	HF207	512993	HFF3026	513463
TU250 X-K9, L0, L1-L5	250	09 - 15	HF136	512955	HFA3105	513245
DR350 SL, SM, SN, SP SK42B	350	90 - 93	HF136	512955	HFF3020	513457
DR350 SE-R, S, T, V, W, X, Y	350	94 - 00	HF136	512955	HFF3020	513457
DR350 L, M, N, P, R, S, T, V	350	90 - 98	HF136	512955	HFF3020	513457
DR350 L, M, N, P, R, S, T, V OFF ROAD	350	90 - 98	HF136	512955	HFF3020	513457
AN400 BURGMAN EITHER OIL FILTER LISTED IS A SUITABLE REPLACEMENT	400	07 - 17	HF131	502305	HFA3401	502247
AN400 BURGMAN (ABS) EITHER OIL FILTER LISTED IS A SUITABLE REPLACEMENT	400	11 - 12	HF131	502305	HFA3401	502247
AN400 Z BURGMAN EXECUTIVE (ABS) EITHER OIL FILTER LISTED IS A SUITABLE REPLACEMENT	400	09 - 16	HF131	502305	HFA3401	502247
DR-Z400 E	400	00 - 07	HF139	512957	HFF3015	513452
DR-Z400 S	400	00 - 19	HF139	512957	HFF3015	513452
DR-Z400 SM	400	05 - 19	HF139	512957	HFF3015	513452
RMX450 Z L0, L1, L2, L3	450	10 - 13	HF207	512993	HFF3021	513458
RMX450 Z L7, L8, L9	450	17 - 19	HF207	512993	HFF3021	513458
RM-Z450 K5, K6, K7, K8, K9, L0, L1, L2, L3, L4, L5, L6, L7	450	05 - 17	HF207	512993	HFF3014	513451
RM-Z450 L8, L9, MO	450	18 - 20	HF207	512993	HFF3026	513463
RM-Z450 M1	450	21	HF207	512993	HFF3026	513463
GS500 E-K, L, M, N, P, R, S, T, V, W, X, Y, K1, K2 (2 CYLINDERS)	500	88 - 02	HF133	512953	HFA3503	513250
GS500 E (EUROPEAN MODEL)	500	88 - 02	HF133	512953	HFA3501	513248
GS500 K3, K4, K5, K6	500	03 - 06	HF133	512953	HFA3503	513250
GS500 F-K4, K5, K6, K7, K8, K9, L0	500	04 - 10	HF133	512953	HFA3503	513250
GS500 H-K7, K8, K9	500	07 - 09	HF133	512953	HFA3503	513250
GSX550 ED, EE, EFE, ES, EF, EG, EU	550	83 - 87	HF133	512953	HFA3502	513249

MOTEUR

CYCLE

PNEUMATIQUE

ATELIER

ACCESSOIRES

ÉLECTRICITÉ

FILTRATION

FREINAGE

TRANSMISSION

Modèle	Cylindrée	Année	HIFLOFILTRO		HIFLOFILTRO	
			Filtre huile Réf. HifloFiltro	Filtre huile Réf. CGN	Filtre air Réf. HifloFiltro	Filtre air Réf. CGN
GSF600 S, T, V, W, X BANDIT	600	95 - 99	HF138	487429	HFA3605	513255
GSF600 Y, K1, K2, K3, K4 BANDIT	600	00 - 04	HF138	487429	HFA3615	-
GSF600 ST, SV, SW, SX BANDIT	600	96 - 99	HF138	487429	HFA3605	513255
GSF600 SY, SK1, SK2, SK3, SK4 BANDIT	600	00 - 04	HF138	487429	HFA3615	-
GSR600 K6, K7, K8, K9, L0	600	06 - 10	HF138	487429	HFA3613	513262
GSR600 B YOSHIMURA	600	10	HF138	487429	HFA3613	513262
GSX600 F, FU, FU2 - J, K GN72B	600	88 - 89	HF138	487429	HFA3603	513253
GSX600 F, FU, FU2 - L, M, N, P, R, S, T, V, W, X, Y GN72B	600	90 - 00	HF138	487429	HFA3602	513252
GSX600 F-K1, K2, K3, K4, K5, K6	600	01 - 06	HF138	487429	HFA3602	513252
GSX-R600 WN, WP	600	92 - 93	HF138	487429	HFA3605	513255
GSX-R600 V, W, X, Y	600	97 - 00	HF138	487429	HFA3705	513274
GSX-R600 K1, K2, K3	600	01 - 03	HF138	487429	HFA3908	513286
GSX-R600 K4, K5	600	04 - 05	HF138	487429	HFA3616	513265
GSX-R600 K6, K7, K8, K9, L0	600	06 - 10	HF138	487429	HFA3617	513266
GSX-R600 L1, L2, L3, L4, L5, L6, L7, L8	600	11 - 18	HF138	487429	HFA3620	513268
GSX-R600 L9	600	19	HF138	487429	HFA3620	513268
GSX-R600 MOTO GP	600	16	HF138	487429	HFA3620	513268
RF600 RP, RR, RS, RT, RV GN76A	600	93 - 97	HF138	487429	HFA3601	513251
VS600 S, T, V BOTH AIR FILTERS REQUIRED	600	95 - 97	HF138	487429	HFA3606 HFA3607	-
VS600 GLF BOTH AIR FILTERS REQUIRED	600	98	HF138	487429	HFA3606 HFA3607	-
AN650 BURGMAN EITHER OIL FILTER LISTED IS A SUITABLE REPLACEMENT	650	02 - 15	HF138	487429	HFA3619	502292
AN650 A / Z BURGMAN EXECUTIVE EITHER OIL FILTER LISTED IS A SUITABLE REPLACEMENT	650	04 - 18	HF138	487429	HFA3619	502292
DL650 K4, K5, K6 V-STROM	650	04 - 06	HF138	487429	HFA3611	513261
DL650 K7, K8, K9, L0, L1, L2 V-STROM	650	07 - 12	HF138	487429	HFA3611	513261
DL650 L0 V-STROM X	650	10	HF138	487429	HFA3611	513261
DL650 A-L0, L1, L2, L3, L4, L5, L6, L7, L8 V-STROM ABS	650	10 - 18	HF138	487429	HFA3611	513261
DL650 A-XA L9 V-STROM ABS	650	19	HF138	487429	HFA3611	513261
DL650 A V-STROM ABS	650	20	HF138	487429	HFA3611	513261
DL650 XA-L5, L6, L7, L8 XT V-STROM ABS	650	15 - 18	HF138	487429	HFA3611	513261
DL650 XA-L9, MO V-STROM XT	650	19 - 20	HF138	487429	HFA3611	513261
DL650 V-STROM XT TOURING	650	19 - 20	HF138	487429	HFA3611	513261
DL650 XA-L9 V-STROM ABS	650	19	HF138	487429	HFA3611	513261
DL650 A V-STROM TRAVELLER	650	10	HF138	487429	HFA3611	513261
DL650 A V-STROM GT	650	10	HF138	487429	HFA3611	513261
DR650 S-L5, L6, L7, L8	650	15 - 19	HF137	512956	HFF3025	513462
DR650 SE-V, W, X, Y, K-K9, L0-L4	650	97 - 14	HF137	512956	HFF3025	513462
GS650 EZ, X, EX	650	81 - 82	HF133	512953	HFA3502	513249
GSF650 BANDIT	650	05 - 08	HF138	487429	HFA3615	
GSF650 BANDIT	650	09 - 11	HF138	487429	HFA3621	513269
GSF650 S BANDIT	650	05 - 08	HF138	487429	HFA3615	

Modèle	Cylindrée	Année	H.FLOFILTRO		H.FLOFILTRO	
			Filtere huile Réf. HilfoFiltro	Filtere huile Réf. CGN	Filtere air Réf. HilfoFiltro	Filtere air Réf. CGN
GSF650 SA BANDIT	650	10 - 14	HF138	487429	HFA3621	513269
GSX650 F-K8, K9, L0, L1, L2, L3, L4, L5	650	08 - 16	HF138	487429	HFA3621	513269
LS650 PL, PM, PN, PR, PS, PT, PV, PW, PX, PY SAVAGE (BELT)	650	91 - 00	HF137	512956	HFA3608	513258
LS650 PK1, PK2, PK3, PK4 SAVAGE (BELT)	650	01 - 04	HF137	512956	HFA3608	513258
LS650 K5, K6, K7, K8, K9 SAVAGE (BELT)	650	05 - 09	HF137	512956	HFA3608	513258
S40 K5, K6, K7, K8, K9, L0, L1-L9 BOULEVARD (LS650)	650	05 - 19	HF137	512956	HFA3608	513258
SFV650 K9, L0, L1, L2, L3, L4, L5 GLADIUS (ABS)	650	09 - 15	HF138	487429	HFA3618	513267
SFV650 AZ GLADIUS SPECIAL EDITION	650	13	HF138	487429	HFA3618	513267
SV650 X, Y, K1, K2	650	99 - 02	HF138	487429	HFA3609	513259
SV650 K3, K4, K5, K6, K7, K8	650	03 - 08	HF138	487429	HFA3612	508245
SV650 SX, SY, SK1, SK2	650	99 - 02	HF138	487429	HFA3609	513259
SV650 SK3, SK4, SK5, SK6, SK7, SK8, SK9, SLO	650	03 - 10	HF138	487429	HFA3612	508245
SV650 A/SA-K7, K8, K9, L0-L5 (ABS)	650	07 - 15	HF138	487429	HFA3612	508245
SV650 A-L7, L8 (ABS)	650	17 - 18	HF138	487429	HFA3618	513267
SV650 A-L9 (ABS)	650	19	HF138	487429	HFA3618	513267
SV650 A	650	20	HF138	487429	HFA3618	513267
SV650 X-L8 (ABS)	650	18	HF138	487429	HFA3618	513267
SV650 XA-L9 (ABS)	650	19	HF138	487429	HFA3618	513267
SV650 X	650	20	HF138	487429	HFA3618	513267
GV700 GLF, GLF2	700	85	HF134	512954	HFA3503	513250
VS700 GLEPG, GLFG, GLPG, GLEFG BOTH AIR FILTERS REQUIRED	700	86	HF134	512954	HFA3606 HFA3607	-
VS700 GLFH, GLPH, GLEFH BOTH AIR FILTERS REQUIRED	700	87 - 88	HF138	487429	HFA3606 HFA3607	-
VS700 GLPJ, GLFJ BOTH AIR FILTERS REQUIRED	700	88	HF138	487429	HFA3606 HFA3607	-
DR750 SJ, SUJ, SK, SUK BIG SR41B	750	88 - 89	HF137	512956	HFA3703	513272
GS750 LN, LT, LX	750	79 - 81	HF133	512953	HFA3702	513271
GS750 SD	750	83	HF133	512953	HFA3702	513271
GSR750 L1, L2, L3, L4, L5, L6 (ABS)	750	11 - 16	HF138	487429	HFA3613	513262
GSR750 Z-L5, L6 (ABS)	750	15 - 16	HF138	487429	HFA3613	513262
GSX750 LN, LT, LX	750	79 - 81	HF133	512953	HFA3702	513271
GSX750 T, ET, X, EX, EZ	750	80 - 82	HF133	512953	HFA3702	513271
GSX750 S, SS (JAPAN) GS75X	750	84 - 85	HF133	512953	HFA3702	513271
GSX750 S-2, S2C (JAPAN) GS75X	750	84 - 85	HF133	512953	HFA3702	513271
GSX750 F-K, L, M, N, P, R, S, T, V, W, X, Y, K1, K2, K3, K4, K5, K6 GR78A	750	89 - 06	HF138	487429	HFA3602	513252
GSX750 W, X, Y, K1 (RETRO STYLE)	750	98 - 02	HF138	487429	HFA3604	513254
GSX-R750 F, G, HG, H, XH GR75A	750	85 - 87	HF134	512954	HFA3701	513270
GSX-R750 J, K SLING SHOT GR77B	750	88 - 89	HF138	487429	HFA3704	513273
GSX-R750 L, M SLING SHOT GR7AD	750	90 - 91	HF138	487429	HFA3704	513273
GSX-R750 WN, WP, WR, WS GR7BD	750	92 - 95	HF138	487429	HFA3605	513255
GSX-R750 T, V, W, X SRAD	750	96 - 99	HF138	487429	HFA3705	513274
GSX-R750 Y, K1, K2, K3	750	00 - 03	HF138	487429	HFA3908	513286

Modèle	Cylindrée	Année	HIFLOFILTRO		HIFLOFILTRO	
			Filtre huile Réf. HifloFiltro	Filtre huile Réf. CGN	Filtre air Réf. HifloFiltro	Filtre air Réf. CGN
GSX-R750 K4, K5	750	04 - 05	HF138	487429	HFA3616	513265
GSX-R750 K6, K7, K8, K9, L0	750	06 - 10	HF138	487429	HFA3617	513266
GSX-R750 L1, L2, L3, L4, L5, L6, L7, L8	750	11 - 18	HF138	487429	HFA3620	513268
GSX-R750 L9	750	19	HF138	487429	HFA3620	513268
GSX-R750 Z-L4	750	14	HF138	487429	HFA3620	513268
GSX-R750 MOTO GP	750	16	HF138	487429	HFA3620	513268
GSX-S750 L5, L6, L7, L8	750	15 - 18	HF138	487429	HFA3613	513262
GSX-S750 Z-L5, L6, L7, L8	750	15 - 18	HF138	487429	HFA3613	513262
VS750 GLF BOTH AIR FILTERS REQUIRED	750	85 - 86	HF134	512954	HFA3606 HFA3607	-
VS750 GLP-H, J, K, L, M INTRUDER BOTH AIR FILTERS REQUIRED	750	87 - 91	HF138	487429	HFA3606 HFA3607	-
C50 L4, L5, L6 BOULEVARD B.O.S.S.	800	14 - 16	HF138	487429	-	-
C50 T-K5-K9, L0-L9 BOULEVARD	800	05 - 19	HF138	487429	-	-
C50 B-K5, K6, K7 BOULEVARD BLACK	800	05 - 07	HF138	487429	-	-
C800 INTRUDER (VL800 INTRUDER)	800	05 - 15	HF138	487429	-	-
DR800 SK, SL, SUL SR43A/B	800	88 - 90	HF137	512956	HFA3703	513272
DR800 SM, SUM SR43A/B	800	91	HF137	512956	HFA3802	513276
DR800 SN, SUN, SP, SUP, SR, SUR, SS, SUS, SV, SUV SR43A/B	800	92 - 00	HF137	512956	HFA3802	513276
M50 K5, K6, K7, K8 BOULEVARD	800	05 - 08	HF138	487429	HFA3804	513278
M800 INTRUDER (VZ800 MARAUDER)	800	05 - 08	HF138	487429	HFA3804	513278
VS800 GL-N, P, R, S, T, V, W, X, Y, K1-K9 INTRUDER (S50 INTRUDER) BOTH AIR FILTERS REQUIRED	800	92 - 09	HF138	487429	HFA3606 HFA3607	-
VX800 L, M, N, P, R, S, T, V	800	90 - 97	HF138	487429	HFA3801	513275
VZ800 V, W, X, Y, K1, K2, K3, K4 MARAUDER	800	97 - 04	HF138	487429	HFA3803	513277
VZ800 K5, K6, K7, K8 M50 MARAUDER	800	05 - 08	HF138	487429	HFA3804	513278
S50 K5, K6, K7, K8, K9 BOULEVARD BOTH AIR FILTERS REQUIRED	800	05 - 09	HF138	487429	HFA3606 HFA3607	-
RF900 RR, RS, RS2, RT, RV, RW, RX, RY	900	94 - 00	HF138	487429	HFA3601	513251
DL1000 K2, K3, K4, K5, K6, K7, K8, K9, L0 V-STROM	1000	02 - 10	HF138	487429	HFA3611	513261
DL1000 SE L0 V-STROM	1000	10	HF138	487429	HFA3611	513261
GS1000 HC, HN, HT	1000	78 - 80	HF133	512953	HFA3702	513271
GS1000 C, EC, N, EN, T, ET	1000	78 - 80	HF133	512953	HFA3702	513271
GS1000 SN, ST, SZ, SD	1000	79 - 83	HF133	512953	HFA3702	513271
GSX1000 SZ, SD KATANA	1000	82 - 84	HF133	512953	HFA3902	513280
GSX-R1000 K1, K2, K3, K4	1000	01 - 04	HF138	487429	HFA3908	513286
GSX-R1000 K5, K6, K7, K8	1000	05 - 08	HF138	487429	HFA3910	513288
GSX-R1000 K9, L0, L1	1000	09 - 11	HF138	487429	HFA3912	513290
GSX-R1000 L2, L3, L4, L5, L6	1000	12 - 16	HF138	487429	HFA3912	513290
GSX-R1000 A-L7, L8, L9, M0 ABS	1000	17 - 20	HF138	487429	HFA3913	-
GSX-R1000 M1	1000	21	HF138	487429	HFA3913	-
GSX-R1000 R/RZ-L7, L8, L9, M0	1000	17 - 20	HF138	487429	HFA3913	-
GSX-R1000 R	1000	21	HF138	487429	HFA3913	-
GSX-R1000 Z L3-L5	1000	13 - 15	HF138	487429	HFA3912	513290

Modèle	Cylindrée	Année	H.FLOFILTRO		H.FLOFILTRO	
			Filtre huile Réf. HilfoFiltro	Filtre huile Réf. CGN	Filtre air Réf. HilfoFiltro	Filtre air Réf. CGN
GSX-R1000 F ABS	1000	15	HF138	487429	HFA3912	513290
GSX-R1000 COMMEMORATIVE ED.	1000	16	HF138	487429	HFA3912	513290
GSX-S1000 L5, L6	1000	15 - 16	HF138	487429	HFA3912	513290
GSX-S1000 A-L5, L6, L7, L8 (ABS)	1000	15 - 18	HF138	487429	HFA3912	513290
GSX-S1000 A-L9 (ABS)	1000	19	HF138	487429	HFA3912	513290
GSX-S1000 A-M0	1000	20	HF138	487429	HFA3912	513290
GSX-S1000 AZ-L9 (ABS)	1000	19	HF138	487429	HFA3912	513290
GSX-S1000 F/FA-L6, L7, L8	1000	16 - 18	HF138	487429	HFA3912	513290
GSX-S1000 F/FA-L9	1000	19	HF138	487429	HFA3912	513290
GSX-S1000 F/FA-M0	1000	20	HF138	487429	HFA3912	513290
GSX-S1000 FZA-L9	1000	19	HF138	487429	HFA3912	513290
GSX-S1000 S/SA-L7	1000	17	HF138	487429	HFA3912	513290
GSX-S1000 SRQ/STQ L9, MO KATANA	1000	19 - 20	HF138	487429	HFA3912	513290
GSX-S1000 Z-L8	1000	18	HF138	487429	HFA3912	513290
GSX-S1000 Z-M0	1000	20	HF138	487429	HFA3912	513290
SV1000 K3, K4, K5, K6, K7	1000	03 - 07	HF138	487429	HFA3612	508245
SV1000 S-K3, K4, K5, K6, K7	1000	03 - 07	HF138	487429	HFA3612	508245
TL1000 S-V, W, X, Y	1000	97 - 00	HF138	487429	HFA3901	513279
TL1000 R-W, X, Y, K1, K2	1000	98 - 02	HF138	487429	HFA3903	513281
GS1100 E-L, ES	1100	80 - 83	HF133	512953	HFA3702	513271
GS1100 LT, Z	1100	80 - 81	HF133	512953	HFA3702	513271
GS1100 ET, EX, EZ, ED	1100	80 - 83	HF133	512953	HFA3702	513271
GS1100 SD, ESD	1100	83	HF133	512953	HFA3702	513271
GSX1100 SZ, SD KATANA	1100	81 - 84	HF133	512953	HFA3902	513280
GSX1100 T, ET, X, EX	1100	80 - 82	HF133	512953	HFA3702	513271
GSX1100 SD, XD, EXD	1100	83	HF133	512953	HFA3902	513280
GSX1100 EZ, SD, ESD	1100	80 - 85	HF133	512953	HFA3902	513280
GSX1100 EE, EF, EG, EFE, EFF, EFG, ESE, ESF, ESG	1100	82 - 87	HF133	512953	HFA3905	513283
GSX1100 F-J, K, L, M, N, P, R, S, T	1100	88 - 96	HF138	487429	HFA3603	513253
GSX-R1100 G, H, J	1100	86 - 88	HF138	487429	HFA3904	513282
GSX-R1100 K, L, M, N	1100	89 - 92	HF138	487429	HFA3704	513273
GSX-R1100 WP, WR, WS, WT, WV	1100	92 - 97	HF138	487429	HFA3605	513255
GSF1200 T, V, W, X BANDIT	1200	96 - 99	HF138	487429	HFA3605	513255
GSF1200 Y, K1, K2, K3, K4 BANDIT	1200	00 - 04	HF138	487429	HFA3615	-
GSF1200 K5, K6 BANDIT	1200	05 - 06	HF138	487429	HFA3615	-
GSF1200 S-T, V, W, X BANDIT	1200	97 - 99	HF138	487429	HFA3605	513255
GSF1200 S-Y, K1, K2, K3, K4 BANDIT	1200	00 - 04	HF138	487429	HFA3615	-
GSF1200 S-K5, K6 BANDIT	1200	05 - 06	HF138	487429	HFA3615	-
GSX1200 INAZUMA	1200	99 - 00	HF138	487429	HFA3503	513250
GV1200 GLF, GLF2, GLG	1200	85 - 86	HF134	512954	HFA3503	513250
GSF1250 S-K7, K8, K9, L0-L6 BANDIT	1250	07 - 16	HF138	487429	HFA3621	513269
GSF1250 SA-K7, K8, K9, L0-L6 BANDIT	1250	07 - 16	HF138	487429	HFA3621	513269
GSF1250 SA-L0 BANDIT TRAVELLER	1250	10	HF138	487429	HFA3621	513269
GSX1250 F/FA-L0, L1, L2, L3, L4, L5, L6	1250	10 - 16	HF138	487429	HFA3621	513269

MOTEUR

CYCLE

PNEUMATIQUE

ATELIER

ACCESSOIRES

ÉLECTRICITÉ

FILTRATION

FREINAGE

TRANSMISSION

Modèle	Cylindrée	Année	HIFLOFILTRO		HIFLOFILTRO	
			Filtre huile Réf. HifloFiltro	Filtre huile Réf. CGN	Filtre air Réf. HifloFiltro	Filtre air Réf. CGN
GSX1250 FAZ-L6	1250	16	HF138	487429	HFA3621	513269
GSX1250 FA-L0 TRAVELLER	1250	10	HF138	487429	HFA3621	513269
GSX-R1300 R-X, Y, K1, K2, K3, K4, K5, K6, K7 HAYABUSA	1300	99 - 07	HF138	487429	HFA3907	513285
GSX-R1300 R-K8, K9, L0, L1, L2, L3, L4, L5, L6, L7, L8 HAYABUSA	1300	08 - 18	HF138	487429	HFA3911	513289
GSX-R1300 R-L9 HAYABUSA	1300	19	HF138	487429	HFA3911	513289
GSX-R1300 RA-L9 HAYABUSA	1300	19	HF138	487429	HFA3911	513289
GSX-R1300 R HAYABUSA 50TH ANNIVERSARY ED.	1300	14	HF138	487429	HFA3911	513289
GSX-R1300 RZ-K2, K3, K4 HAYABUSA	1300	02 - 04	HF138	487429	HFA3907	513285
GSX1400 K1, K2, K3, K4, K5.K6	1400	01 - 06	HF138	487429	HFA3909	513287
VL1500 LC INTRUDER	1500	98 - 04	HF138	487429	HFA3906	513284
MI09R BOULEVARD LIMITED EDITION	1800	09 - 14	HF138	487429	-	-
MI09R2 BOULEVARD	1800	09 - 10	HF138	487429	-	-
VZR1800 INTRUDER MI800 R	1800	06 - 12	HF138	487429	-	-
VZR1800 N INTRUDER MI800 R2	1800	9	HF138	487429	-	-
VZR1800 INTRUDER MI800 RZ	1800	10 - 13	HF138	487429	-	-
VZR1800 INTRUDER MI800 RB	1800	14	HF138	487429	-	-
VZR1800 INTRUDER MI800 BZ	1800	15 - 19	HF138	487429	-	-
ALT125 D, E, F, G	125	83 - 86	HF131	502305	-	-
ALT185 E, F	185	84 - 85	HF131	502305	-	-
LT 125 D, E, F, G, H	125	83 - 87	HF131	502305	-	-
LT-F160 M, N, P, R, S, T, V, W	160	91 - 98	HF132	500772	-	-
LT-F160 X, Y, K1, K2	160	99 - 02	HF132	500772	-	-
LT160 K3, K4 QUADRUNNER	160	03 - 04	HF132	500772	-	-
LT185 E, F, G, H	185	84 - 87	HF131	502305	-	-
LT-F250 K3, K4, K5, K6, K7, K8, K9, L0-L6 OZARK	250	03 - 16	HF132	500772	HFF3024	513461
KLT-A400 F-K9, L0, L1-L9 KING QUAD 400 A	400	09 - 19	HF138	487429	HFF3022	513459
KLT-A400 F-M0 KING QUAD 400 A	400	20	HF138	487429	HFF3022	513459
KLT-A400 FC-K9, L0, L1-L9 KING QUAD 400 AS CAMO	400	09 - 19	HF138	487429	HFF3022	513459
KLT-A400 X KING QUAD 400 ASI SPECIAL EDITION	400	17 - 18	HF138	487429	HFF3022	513459
KLT-F400 F-K9, L0, L1-L8 KING QUAD 400 FS	400	09 - 18	HF138	487429	HFF3022	513459
KLT-F400 FC-K9, L0, L1-L6 KING QUAD 400 FS CAMO	400	09 - 16	HF138	487429	HFF3022	513459
LT-A400 K2, K3, K4 EIGER 2X4 AUTOMATIC	400	02 - 04	HF138	487429	HFF3022	513459
LT-A400 F-K7 EIGER 4X4 AUTOMATIC	400	7	HF138	487429	HFF3022	513459
LT-F400 K2, K3, K4 EIGER 2X4	400	02 - 04	HF138	487429	HFF3022	513459
LTF400 K7 EIGER 2WD	400	7	HF138	487429	HFF3022	513459
LT-F400 F-K2, K3, K4 EIGER 4X4	400	02 - 04	HF138	487429	HFF3022	513459
LT-A400 F-K2, K3, K4, K5, K6 EIGER 4X4 AUTOMATIC	400	02 - 07	HF138	487429	HFF3022	513459

Modèle	Cylindrée	Année	HIFLOFILTRO		HIFLOFILTRO	
			Filtre huile Réf. HifloFiltro	Filtre huile Réf. CGN	Filtre air Réf. HifloFiltro	Filtre air Réf. CGN
LT-F400 FC-K4, K5, K6, K7 EIGER AUTOMATIC 4X4 CAMOUFLAGE	400	04 - 07	HF138	487429	HFF3022	513459
LT-Z400 K3, K4, K5, K6, K7, K8, K9, L0-L6 QUADSPORT	400	03 - 16	HF139	512957	HFF3022	513459
LT-A450 X K7, K8 KING QUAD	450	07 - 08	HF138	487429	-	-
LT-A450 X-K9, L0 KING QUAD 450 AXI	450	09 - 10	HF138	487429	-	-
LT-A450 XC-K9 KING QUAD 450 AXI CAMO	450	9	HF138	487429	-	-
LT-R450 K6, K7, K8, K9 QUADRACER	450	06 - 09	HF139	512957	HFF3023	513460
LT-F500 F QUADRUNNER	500	98 - 02	HF138	487429	-	-
LT-A500 F QUADRUNNER	500	98 - 02	HF138	487429	-	-
LT-A500 X L1-L9 KING QUAD AXI	500	11 - 19	HF138	487429	-	-
LT-A500 X M0 KING QUAD AXI	500	20	HF138	487429	-	-
LT-A500 XC L1-L8 KING QUAD AXI CAMO	500	11 - 18	HF138	487429	-	-
LT-A500 XP-K9, L0-L9 KING QUAD AXI POWER STEERING	500	09 - 19	HF138	487429	-	-
LT-A500 XP M0 KING QUAD AXI POWER STEERING	500	20	HF138	487429	-	-
LT-A500 XPC L1-L8 KING QUAD AXI POWER STEERING CAMO	500	11 - 18	HF138	487429	-	-
LT-A500 XPZ-L7, L8, L9 KING QUAD AXI POWER STEERING SPECIAL ED	500	17 - 19	HF138	487429	-	-
LT-A500 XPZ M0 KING QUAD AXI POWER STEERING SE	500	20	HF138	487429	-	-
LT-F500 F-K2, K3, K4, K5, K6, K7 VINSON 4X4	500	02 - 06	HF138	487429	HFF3022	513459
LT-F500 FC-K5, K6, K7 VINSON 4X4 MANUAL CAMOUFLAGE	500	05 - 06	HF138	487429	HFF3022	513459
LT-A500 F-K3, K4, K5, K6, K7 VINSON AUTOMATIC 4X4	500	03 - 07	HF138	487429	HFF3022	513459
LT-A500 FB-K4, K5 VINSON AUTOMATIC 4X4	500	04 - 05	HF138	487429	HFF3022	513459
LT-A500 FC-K4, K5, K6 VINSON AUTOMATIC 4X4 CAMOUFLAGE	500	04 - 06	HF138	487429	HFF3022	513459
LT-A700 X-K5, K6, K7, K8 KING QUAD	700	05 - 08	HF138	487429	-	-
LT-V700 F-K4, K5, K6 TWIN PEAKS 4X4	700	04 - 06	HF204	487431	-	-
LT-A750 X-K8, K9, L0-L9 KING QUAD 750 AXI	750	08 - 19	HF138	487429	-	-
LT-A750 X-M0 KING QUAD 750 AXI	750	20	HF138	487429	-	-
LT-A750 XK-K9, L0-L8 KING QUAD 750 AXI CAMO	750	09 - 18	HF138	487429	-	-
LT-A750 XCK-K9 KING QUAD 750 AXI CAMO	750	9	HF138	487429	-	-
LT-A750 XP-L1-L9 KING QUAD 750 AXI POWER STEERING	750	11 - 19	HF138	487429	-	-
LT-A750 XP-M0 KING QUAD 750 AXI POWER STEERING	750	20	HF138	487429	-	-
LT-A750 XPC-L1-L8 KING QUAD 750 AXI POWER STEERING CAMO	750	11 - 18	HF138	487429	-	-
LT-A750 XPZ-L9 KING QUAD 750 AXI POWER STEERING SPECIAL ED	750	19	HF138	487429	-	-
LT-A750 XPZ-M0 KING QUAD 750 AXI POWER STEERING SE	750	20	HF138	487429	-	-

Modèle	Cylindrée	Année	HIFLOFILTRO		HIFLOFILTRO	
			Filtre huile Réf. HifloFiltro	Filtre huile Réf. CGN	Filtre air Réf. HifloFiltro	Filtre air Réf. CGN
SYM						
125 HD EU / EVO / IE	125	03 - 13	-	-	HFA5104	502275
125 HD2	125	11 - 15	-	-	HFA5104	502275
125 COMBIZ	125	11 - 15	-	-	HFA5108	
125 JOYRIDE	125	01 - 02	-	-	HFA5101	502272
125 JOYRIDE / JOYRIDE EVO EURO2/ EURO3	125	03 - 15	-	-	HFA5102	502273
125 MEGALO	125	06 - 08	-	-	HFA5101	502272
125 RV	125	01 - 03	-	-	HFA5101	502272
125 SYMPHONY / DD 4T	125	09 - 15	-	-	HFA5101	502272
125 SYMPHONY S 4T	125	09 - 15	-	-	HFA5101	502272
125 SYMPHONY SR 4T	125	09 - 15	-	-	HFA5101	502272
125 VS	125	06 - 12	-	-	HFA5103	502274
150 ATTILA	150	00 - 01	-	-	HFA5101	502272
150 JOYRIDE	150	01 - 02	-	-	HFA5101	502272
150 RV	150	01 - 03	-	-	HFA5101	502272
150 SYMPHONY / DD 4T	150	09 - 14	-	-	HFA5101	502272
150 SYMPHONY S 4T	150	09 - 14	-	-	HFA5101	502272
150 SYMPHONY SR 4T	150	09 - 14	-	-	HFA5101	502272
150 VS	150	06 - 12	-	-	HFA5103	502274
180 RV	180	01 - 03	-	-	HFA5101	502272
200 HD EU / EVO / IE	200	03 - 13	-	-	HFA5104	502275
200 HD2	200	11 - 15	-	-	HFA5104	502275
200 JOYRIDE	200	2	-	-	HFA5101	502272
200 JOYRIDE / JOYRIDE EVO EURO2/ EURO3	200	03 - 15	-	-	HFA5102	502273
250 JOYMAX GTS IE EURO 3	250	06 - 08	-	-	HFA5107	513358
300 CITYCOM / S / EFI	300	07 - 15	-	-	HFA5105	502276
300 JOYMAX EVO IE	300	09 - 12	-	-	HFA5107	513358
300 JOYMAX I / EFI / ABS EURO 3	300	13 - 15	-	-	HFA5107	513358
400I MAX SYM EITHER OIL FILTER LISTED IS A SUITABLE REPLACEMENT	400	11 - 15	HF132	500772	-	-
600I MAX SYM EITHER OIL FILTER LISTED IS A SUITABLE REPLACEMENT	400	16	HF132	500772	-	-
TGB						
400 AVENGER LE / R	400	07 - 10	HF148	512962	-	-
400 TARGET E / LE	400	06 - 10	HF148	512962	-	-
425 AVENGER	425	07 - 10	HF148	512962	-	-
425 BLADE	425	08 - 10	HF148	512962	-	-
425 OUTBACK	425	07 - 08	HF148	512962	-	-
425 TARGET	425		HF148	512962	-	-
450 BLADE SE	450	10 -	HF148	512962	-	-
500 BLADE R	500	10 - 14	HF148	512962	-	-
500 AVENGER R	500		HF148	512962	-	-
500 TARGET R 4X2 / 4X4	500	10 - 14	HF148	512962	-	-
525 BLADE R IRS / SE	525	09 - 14	HF148	512962	-	-

Modèle	Cylindrée	Année	H.FLOFILTRO		H.FLOFILTRO	
			Filtre huile Réf. HilfoFiltro	Filtre huile Réf. CGN	Filtre air Réf. HilfoFiltro	Filtre air Réf. CGN
525 TARGET	525	08 - 10	HF148	512962	-	-
550 BLADE	550	09 - 14	HF148	512962	-	-
550 BLADE LT IRS	550	09 - 14	HF148	512962	-	-
550 TARGET IRS	550	10 - 14	HF148	512962	-	-
TM RACING						
250 4T	250	7	HF142	512959	-	-
250 4T	250	08 - 15	HF141	494343	-	-
450 4T	450	07 - 10	HF142	512959	-	-
450 4T	450	11 - 15	HF141	494343	-	-
530 4T	530	07 - 15	HF141	494343	-	-
660 4T	660	08 - 09	HF142	512959	-	-
TRIUMPH						
600 DAYTONA	600	03 - 04	HF191	506232	-	-
600 SPEED FOUR	600	03 - 04	HF191	506232	-	-
600 SPEED FOUR	600	05 - 06	HF204	487431	-	-
600 TT	600	00 - 05	HF191	506232	-	-
650 DAYTONA	650	5	HF204	487431	-	-
660 STREET TRIPLE S A2 LICENCE	660	18	HF204	487431	-	-
675 DAYTONA (VIN < 564947)	675	06 - 10	HF204	487431	HFA6505	510101
675 DAYTONA (VIN 564948 >)	675	11 - 16	HF204	487431	HFA6502	513396
675 DAYTONA R (VIN 564948 >)	675	11 - 16	HF204	487431	HFA6502	513396
675 STREET TRIPLE (VIN < 560476)	675	08 - 10	HF204	487431	HFA6505	510101
675 STREET TRIPLE (VIN 560477 >)	675	11 - 16	HF204	487431	HFA6502	513396
675 STREET TRIPLE R (VIN 560477 >)	675	10 - 16	HF204	487431	HFA6502	513396
750 DAYTONA	750	91 - 95	HF192	512988	-	-
750 SPEED TRIPLE	750	97	HF192	512988	-	-
750 THUNDERBIRD	750	95	HF192	512988	-	-
750 TRIDENT	750	91 - 98	HF192	512988	-	-
765 STREET TRIPLE R	765	17 - 20	HF204	487431	HFA6506	513399
765 STREET TRIPLE R LOW	765	18 - 20	HF204	487431	HFA6506	513399
765 STREET TRIPLE RS	765	17 - 20	HF204	487431	HFA6506	513399
765 STREET TRIPLE S	765	17 - 20	HF204	487431	HFA6506	513399
800 AMERICA	800	02 - 04	HF191	506232	-	-
800 AMERICA	800	05 - 06	HF204	487431	-	-
800 BONNEVILLE	800	01 - 04	HF191	506232	HFA6504	513398
800 BONNEVILLE	800	05 - 06	HF204	487431	HFA6504	513398
800 BONNEVILLE T100 (CENTENNIAL EDITION)	800	2	HF191	506232	HFA6504	513398
800 BONNEVILLE T100	800	03 - 04	HF191	506232	HFA6504	513398
800 BONNEVILLE T100	800	5	HF204	487431	HFA6504	513398
800 SPEEDMASTER	800	03 - 04	HF191	506232	-	-
800 SPEEDMASTER	800	5	HF204	487431	-	-
800 TIGER	800	11 - 16	HF204	487431	HFA6501	513395
800 TIGER XC / XCA / XCX	800	11 - 17	HF204	487431	HFA6501	513395
800 TIGER XR / XRT / XRX	800	15 - 17	HF204	487431	HFA6501	513395

MOTEUR

CYCLE

PNEUMATIQUE

ATELIER

ACCESSOIRES

ÉLECTRICITÉ

FILTRATION

FREINAGE

TRANSMISSION

Modèle	Cylindrée	Année	HIFLOFILTRO		HIFLOFILTRO	
			Filtre huile Réf. HifloFiltro	Filtre huile Réf. CGN	Filtre air Réf. HifloFiltro	Filtre air Réf. CGN
800 TIGER XR	800	19 - 20	HF204	487431	HFA6501	513395
800 TIGER XRX	800	19 - 20	HF204	487431	HFA6501	513395
800 TIGER XRX LOW	800	19 - 20	HF204	487431	HFA6501	513395
800 TIGER XRT	800	19 - 20	HF204	487431	HFA6501	513395
800 TIGER XCX	800	19 - 20	HF204	487431	HFA6501	513395
800 TIGER XCA	800	19 - 20	HF204	487431	HFA6501	513395
865 AMERICA	865	07 - 17	HF204	487431	-	-
865 AMERICA LT	865	14 - 17	HF204	487431	-	-
865 BONNEVILLE	865	07 - 16	HF204	487431	HFA6504	513398
865 BONNEVILLE BLACK	865	07 - 08	HF204	487431	HFA6504	513398
865 BONNEVILLE T100	865	07 - 16	HF204	487431	HFA6504	513398
865 BONNEVILLE T100 110TH ANNIVERSARY EDITION	865	13	HF204	487431	HFA6504	513398
865 BONNEVILLE SE	865	09 - 12	HF204	487431	HFA6504	513398
865 BONNEVILLE STEVE MCQUEEN EDITION	865	13	HF204	487431	HFA6504	513398
865 SCRAMBLER	865	07 - 17	HF204	487431	HFA6504	513398
865 SPEEDMASTER	865	07 - 17	HF204	487431	-	-
865 THRUXTON	865	07 - 15	HF204	487431	HFA6504	513398
900 ADVENTURER	900	95 - 01	HF192	512988	-	-
900 BONNEVILLE T100	900	6	HF204	487431	-	-
900 BONNEVILLE T100	900	17 - 18	HF204	487431	-	-
900 BONNEVILLE T100	900	19 - 20	HF204	487431	HFA6509	-
900 BONNEVILLE T100 BLACK	900	17 - 18	HF204	487431	-	-
900 BONNEVILLE T100 BLACK	900	19 - 20	HF204	487431	HFA6509	-
900 DAYTONA	900	94 - 97	HF192	512988	-	-
900 LEGEND TT	900	99 - 01	HF192	512988	-	-
900 SCRAMBLER	900	6	HF204	487431	-	-
900 SPRINT SPORTS	900	95 - 98	HF192	512988	-	-
900 SPEED TRIPLE	900	94 - 96	HF192	512988	-	-
900 SPEEDMASTER	900	6	HF204	487431	-	-
900 STREET CUP	900	16 - 18	HF204	487431	HFA6509	-
900 STREET CUP	900	19	HF204	487431	HFA6509	-
900 STREET SCRAMBLER	900	16 - 18	HF204	487431	HFA6509	-
900 STREET SCRAMBLER	900	19 - 20	HF204	487431	HFA6509	-
900 STREET TWIN	900	16 - 18	HF204	487431	HFA6509	-
900 STREET TWIN	900	19 - 20	HF204	487431	HFA6509	-
900 THRUXTON	900	04 - 06	HF204	487431	-	-
900 THUNDERBOLT	900	96	HF192	512988	-	-
900 THUNDERBIRD	900	95 - 03	HF192	512988	-	-
900 THUNDERBIRD SPORT	900	99 - 03	HF192	512988	-	-
900 TIGER	900	91 - 00	HF192	512988	-	-
900 TIGER	900	20	HF204	487431	-	-
900 TIGER GT	900	20	HF204	487431	-	-
900 TIGER GT	900	21	HF204	487431	-	-

Modèle	Cylindrée	Année	HIFLOFILTRO		HIFLOFILTRO	
			Filtre huile Réf. HifloFiltro	Filtre huile Réf. CGN	Filtre air Réf. HifloFiltro	Filtre air Réf. CGN
900 TIGER GT LOW	900	21	HF204	487431	-	-
900 TIGER GT PRO	900	21	HF204	487431	-	-
900 TIGER RALLY	900	20	HF204	487431	-	-
900 TIGER RALLY	900	21	HF204	487431	-	-
900 TIGER RALLY PRO	900	21	HF204	487431	-	-
900 TRIDENT	900	91 - 98	HF192	512988	-	-
900 TROPHY	900	91 - 01	HF192	512988	-	-
T595 DAYTONA	955	97 - 98	HF191	506232	-	-
955I DAYTONA	955	99 - 01	HF191	506232	-	-
955I DAYTONA (VIN 132513 >)	955	02 - 04	HF191	506232	HFA6503	513397
955I DAYTONA	955	05 - 06	HF204	487431	HFA6503	513397
T509 SPEED TRIPLE	955	97 - 98	HF191	506232	-	-
955I SPEED TRIPLE	955	99 - 01	HF191	506232	-	-
955I SPEED TRIPLE (VIN 141872 TO 210444)	955	02 - 04	HF191	506232	HFA6503	513397
955I SPEED TRIPLE	955	5	HF204	487431	-	-
955 SPRINT RS	955	1	HF191	506232	-	-
955 SPRINT RS (VIN 139277 >)	955	02 - 04	HF191	506232	HFA6503	513397
955 SPRINT ST	955	1	HF191	506232	-	-
955 SPRINT ST (VIN 139277 TO 208166)	955	02 - 04	HF191	506232	HFA6503	513397
955 SPRINT ST	955	5	HF204	487431	-	-
955 TIGER	955	01 - 04	HF191	506232	-	-
955 TIGER	955	05 - 06	HF204	487431	-	-
1000 DAYTONA	1000	91 - 95	HF192	512988	-	-
1050 SPEED TRIPLE	1050	06 - 17	HF204	487431	-	-
1050 SPEED TRIPLE R	1050	12 - 18	HF204	487431	-	-
1050 SPEED TRIPLE S	1050	16 - 18	HF204	487431	-	-
1050 SPEED 94 / 94R	1050	16	HF204	487431	-	-
1050 SPRINT GT	1050	11 - 15	HF204	487431	-	-
1050 SPRINT GT SE	1050	16 - 18	HF204	487431	-	-
1050 SPRINT ST	1050	06 - 11	HF204	487431	-	-
1050 TIGER	1050	07 - 15	HF204	487431	-	-
1050 TIGER SPORT	1050	16 - 20	HF204	487431	-	-
1050 TIGER SE (ABS)	1050	10 - 15	HF204	487431	-	-
1200 DAYTONA	1200	93 - 97	HF192	512988	-	-
1200 BONNEVILLE T120	1200	16 - 19	HF204	487431	HFA6509	-
1200 BONNEVILLE T120 BLACK	1200	16 - 19	HF204	487431	HFA6509	-
1200 BONNEVILLE BOBBER (HFA6507 LEFT SIDE FILTER) BOTH AIR FILTERS REQUIRED	1200	17 - 19	HF204	487431	HFA6507 HFA6508	-
YAMAHA						
XT225 D, E, F, G, H, J, K, L, M SEROW	225	92 - 00	HF143	450791	-	-
XT225 N, P, R, S, T, V, W	225	01 - 07	HF143	450791	-	-
TT225 S, T	225	86 - 87	HF143	450791	-	-
TT-R225	225	00 - 04	HF143	450791	-	-
XT600 KN, KH 3UW, 3TB	600	91 - 95	HF145	487430	HFA4608	513313

Modèle	Cylindrée	Année	HIFLOFILTRO		HIFLOFILTRO	
			Filtre huile Réf. HifloFiltro	Filtre huile Réf. CGN	Filtre air Réf. HifloFiltro	Filtre air Réf. CGN
YX600 C-S, T, U, W, A RADIANT	600	86 - 90	HF144	512960	HFA4504	513305
YZF600 R-G, GC, H, HC THUNDERCAT (USA)	600	95 - 96	HF303	493942	HFA4604	513309
YZF600 R-H, HC THUNDERCAT 4TV/4WD	600	96	HF303	493942	HFA4611	513316
YZF600 R-J, JC, K, KC, L, LC, M, MC THUNDERCAT 4TV/4WD	600	97 - 00	HF303	493942	HFA4611	513316
YZF600 R-N, NC, P, PC.R.RC THUNDERCAT 4TV/4WD	600	01 - 03	HF303	493942	HFA4611	513316
YZF600 R-S, SC, T, TC, V, VC, W, WC (USA)	600	04 - 07	HF303	493942	HFA4611	513316
YZF-R6 5EB, 5MT	600	99 - 02	HF303	493942	HFA4610	513315
YZF-R6 13SI, 13SB	600	08 - 09	HF204	487431	HFA4614	513319
YZF-R6 13SL, 1JS, 2CX	600	10 - 16	HF204	487431	HFA4614	513319
YZF-R6	600	17 - 18	HF204	487431	HFA4614	513319
YZF-R6 BN6H	600	19	HF204	487431	HFA4614	513319
YZF-R6 50TH ANNIVERSARY EDITION	600	12	HF204	487431	HFA4614	513319
YZF-R6 60TH ANNIVERSARY EDITION	600	16	HF204	487431	HFA4614	513319
XJ650 G, H, J, K MAXIM	650	80 - 84	HF144	512960	HFA4609	513314
XJ650 LH MIDNIGHT	650	81	HF144	512960	HFA4609	513314
XJ650 RJ SECA	650	82	HF144	512960	HFA4609	513314
XJ650 LK SECA	650	83	HF144	512960	HFA4609	513314
XVS650 DRAG STAR 4VR	650	97 - 04	HF145	487430	HFA4607	513312
XVS650 A DRAG STAR CLASSIC 5BN	650	98 - 05	HF145	487430	HFA4607	513312
XVS650 V-STAR CUSTOM (USA)	650	02 - 16	HF145	487430	HFA4607	513312
XVS650 V-M V-STAR MIDNIGHT CUSTOM (USA)	650	06 - 10	HF145	487430	HFA4607	513312
XVS650 A V-STAR CLASSIC (USA)	650	98 - 10	HF145	487430	HFA4607	513312
XVS650 AT V-STAR SILVERADO (USA)	650	02 - 10	HF145	487430	HFA4607	513312
MT-03 5YK	660	06 - 12	HF145	487430	HFA4613	513318
SZR660	660	96 - 98	HF145	487430	HFA4905	513334
XT660 R 5VK	660	04 - 16	HF145	487430	HFA4613	513318
XT660 X SUPER MOTARD ID2, 10S	660	04 - 16	HF145	487430	HFA4613	513318
XTZ660 TENERE 3YF, 4MY, 4NV	660	91 - 95	HF145	487430	HFA4608	513313
XT660 Z TENERE (ABS) 11D	660	08 - 16	HF145	487430	HFA4616	513321
FZ700 T, TC	700	87	HF401	512994	HFA4603	513308
FZ-07 (ABS)	700	15 - 16	HF204	487431	HFA4707	513328
MT-07 (ABS) 1WS/1XB/B4C	700	14 - 19	HF204	487431	HFA4707	513328
MT-07 MOTO CAGE (ABS)	700	15 - 16	HF204	487431	HFA4707	513328
XSR700 G, H, L (MTM690) B34	700	16 - 18	HF204	487431	HFA4707	513328
XSR700	700	19 - 20	HF204	487431	HFA4707	513328
XTZ690 TENERE 700	700	20	HF204	487431	HFA4707	513328
XV700 L, LC, N, NC	700	84 - 87	HF145	487430	HFA4702	513323
XV700 CS, CSC, SS, SSC, CT, CTC, ST, STC	700	86 - 87	HF145	487430	HFA4702	513323
700 TRACER A (ABS) BC62	700	16 - 17	HF204	487431	HFA4707	513328
700 TRACER A (ABS) BC65	700	18	HF204	487431	HFA4707	513328
700 TRACER A (ABS)	700	19 - 20	HF204	487431	HFA4707	513328

Modèle	Cylindrée	Année	H.FLOFILTRO		H.FLOFILTRO	
			Filtre huile Réf. HilfoFiltro	Filtre huile Réf. CGN	Filtre air Réf. HilfoFiltro	Filtre air Réf. CGN
700 TRACER GT (ABS)	700	19	HF204	487431	HFA4707	513328
MTT690 TRACER 7	700	21	HF204	487431	HFA4707	513328
MTT690 TRACER 7 GT	700	21	HF204	487431	HFA4707	513328
FZ750 N, S, SC, U, UC	750	85 - 88	HF401	512994	HFA4603	513308
FZ750 GENESIS	750	87 - 94	HF401	512994	HFA4603	513308
FZ-07 F, G, H	750	15 - 17	HF204	487431	HFA4707	513328
FZR750 RT, RU GENESIS 2TT	750	87 - 88	HF401	512994	HFA4603	513308
FZR750 R (JAPAN) 3FV	750	89 - 90	HF401	512994	HFA4705	513326
FZR750 (OW01) 3PJ	750	90 - 92	HF303	493942	HFA4705	513326
XJ750 RH, RJ, RK, J, K	750	81 - 84	HF144	512960	HFA4609	513314
XTZ750 SUPER TENERE 3LD, 3WM	750	90 - 97	HF145	487430	HFA4704	513325
XV750 SE 5G5	750	81 - 83	HF145	487430	HFA4703	513324
XV750 H, J, K, MK	750	81 - 83	HF145	487430	HFA4703	513324
XV750 B, D, E, F, G, H, J VIRAGO 4FY, 4PW	750	92 - 99	HF145	487430	HFA4702	513323
YZF750 R 4HN	750	93 - 98	HF303	493942	HFA4706	513327
YZF750 SP 4HT	750	93 - 98	HF303	493942	HFA4706	513327
FZ8 N, NA 39P, 25H, 58P	800	10 - 15	HF204	487431	HFA4917	513345
FZ8 S, SA FAZER 8 42P, 1BD	800	10 - 16	HF204	487431	HFA4917	513345
FJ-09	850	15 - 17	HF204	487431	HFA4921	513349
FZ-09 (USA) 1RC	850	14 - 17	HF204	487431	HFA4921	513349
MT-09 (ABS) 1RC, 2DR	850	14 - 20	HF204	487431	HFA4921	513349
MT-09 SR STREET RALLY (ABS)	850	14 - 16	HF204	487431	HFA4921	513349
MT-09 SPORT TRACKER (ABS)	850	15 - 16	HF204	487431	HFA4921	513349
MT-09 TRACER (ABS) 2SC	850	15 - 17	HF204	487431	HFA4921	513349
MT-09 SP (ABS)	850	18	HF204	487431	HFA4921	513349
MT-09 SP (ABS)	850	19	HF204	487431	HFA4921	513349
MXT850 NIKEN BD51	850	18	HF204	487431	HFA4921	513349
MXT850 D NIKEN B5B1	850	19 - 20	HF204	487431	HFA4921	513349
MXT850 D NIKEN GT	850	19 - 20	HF204	487431	HFA4921	513349
TDM850 4CM, 3VD, 4TX	850	91 - 01	HF145	487430	HFA4603	513308
TRX850	850	95 - 00	HF145	487430	HFA4801	513329
XS850 G, LG, SG, H, LH, SH	850	80 - 81	HF146	512961	HFA4701	513322
XSR900 G, GC, H, HC, J, JC, K, KC	850	16 - 20	HF204	487431	HFA4921	513349
900 TRACER (MTT850) ABS	850	18 - 20	HF204	487431	HFA4921	513349
900 TRACER D GT (MTT850) ABS	850	18 - 20	HF204	487431	HFA4921	513349
TDM900 5PS	900	02 - 12	HF145	487430	HFA4915	513343
TDM900 A ABS 2BO	900	05 - 12	HF145	487430	HFA4915	513343
XJ900 RK SECA	900	82 - 83	HF144	512960	HFA4901	513330
XJ900 F 58L, 4BB	900	84 - 93	HF144	512960	HFA4901	513330
XJ900 S DIVERSION 4KM	900	94 - 03	HF303	493942	HFA4603	513308
XV920 RH, RJ	920	81 - 82	HF145	487430	HFA4703	513324
XVS950 A MIDNIGHT STAR 26P	950	09 - 16	HF204	487431	HFA4919	513347
XVS950 V-STAR 5S7	950	09 - 16	HF204	487431	HFA4919	513347
XVS950 CT V-STAR TOURER 26S	950	09 - 17	HF204	487431	HFA4919	513347

Modèle	Cylindrée	Année	HIFLOFILTRO		HIFLOFILTRO	
			Filtre huile Réf. HifloFiltro	Filtre huile Réf. CGN	Filtre air Réf. HifloFiltro	Filtre air Réf. CGN
FZR1000 GENESIS 2LA	1000	87 - 88	HF401	512994	HFA4603	513308
FZR1000 RA (EXUP) 3LE	1000	89 - 90	HF401	512994	HFA4902	513331
FZR1000 RB, RD, RE, RF (EXUP) 3LE	1000	91 - 94	HF303	493942	HFA4902	513331
FZS1000 FAZER 5LV, 1C2	1000	01 - 05	HF303	493942	HFA4911	513339
FZ1 N 2D1, 1EC	1000	06 - 15	HF204	487431	HFA4917	513345
FZ1 NA ABS 22C	1000	08 - 15	HF204	487431	HFA4917	513345
FZ1 S FAZER 3C3, 5D0, 1CA	1000	06 - 13	HF204	487431	HFA4917	513345
FZ1 SA FAZER ABS 5D0	1000	08 - 12	HF204	487431	HFA4917	513345
FZ-10 H, HC (USA)	1000	17	HF204	487431	HFA4924	-
GTS1000 A (AIR FILTER - 2PCS X HFA4909 REQUIRED) 4BH	1000	93 - 00	HF303	493942	HFA4909	503911
MT-10 ABS	1000	16 - 19	HF204	487431	HFA4924	-
MT-10 SP	1000	17 - 19	HF204	487431	HFA4924	-
TRI (XV1000) 5A8	1000	81 - 85	HF145	487430	HFA4703	513324
XV1000 SE, L, LC, N, NC VIRAGO	1000	83 - 85	HF145	487430	HFA4702	513323
XV1000 SE 3DR	1000	88 - 89	HF145	487430	HFA4702	513323
YZF1000 THUNDER ACE 3SV, 4VD, 45V	1000	96 - 02	HF303	493942	HFA4902	513331
YZF-R1 4XV, 5JJ	1000	98 - 01	HF303	493942	HFA4907	513336
YZF-R1 5PW	1000	02 - 03	HF303	493942	HFA4916	513344
YZF-R1 14B, 1KB	1000	09 - 14	HF204	487431	HFA4923	513351
YZF-R1	1000	15 - 20	HF204	487431	HFA4924	-
YZF-R1 M	1000	15 - 18	HF204	487431	HFA4924	-
YZF-R1 M	1000	20	HF204	487431	HFA4924	-
YZF-R1 S	1000	17 - 18	HF204	487431	HFA4924	-
YZF-R1 50TH ANNIVERSARY EDITION	1000	12	HF204	487431	HFA4923	513351
YZF-R1 60TH ANNIVERSARY EDITION	1000	16	HF204	487431	HFA4924	-
BT1100 BULLDOG	1100	02 - 06	HF145	487430	HFA4603	513308
FJ1100	1100	84 - 86	HF401	512994	HFA4904	513333
XS1100 S, E, F, G, H	1100	78 - 84	HF146	512961	HFA4903	513332
XV1100 S, T, C, U, D, E, F, G, H VIRAGO	1100	89 - 96	HF145	487430	HFA4702	513323
XV1100 VIRAGO	1100	97 - 00	HF145	487430	HFA4702	513323
XVS1100 DRAG STAR 5EL	1100	99 - 05	HF145	487430	HFA4913	513341
XVS1100 A DRAG STAR CLASSIC 5K3	1100	99 - 05	HF145	487430	HFA4913	513341
XVS1100 V-STAR CUSTOM (USA)	1100	02 - 09	HF145	487430	HFA4913	513341
XVS1100 V-F V-STAR CUSTOM (WITH FLAMES) (USA)	1100	6	HF145	487430	HFA4913	513341
XVS1100 AW V-STAR CLASSIC (USA)	1100	99 - 09	HF145	487430	HFA4913	513341
XVS1100 AT V-STAR SILVERADO (USA)	1100	02 - 09	HF145	487430	HFA4913	513341
XVS1100 M V-STAR CUSTOM MIDNIGHT (USA)	1100	07 - 09	HF145	487430	HFA4913	513341
FJ1200	1200	86 - 95	HF401	512994	HFA4904	513333
FJ1200 A ABS	1200	91 - 95	HF401	512994	HFA4904	513333
XJR1200	1200	95 - 98	HF401	512994	HFA4906	513335
XJR1200 SP	1200	97 - 98	HF401	512994	HFA4906	513335
VMX1200 (V-MAX)	1200	85 - 95	HF146	512961	HFA4910	513338
VMX1200 (V-MAX)	1200	96 - 07	HF303	493942	HFA4910	513338

Modèle	Cylindrée	Année	H.FLOFILTRO		H.FLOFILTRO	
			Filtre huile Réf. HilfoFiltro	Filtre huile Réf. CGN	Filtre air Réf. HilfoFiltro	Filtre air Réf. CGN
XTI200 Z SUPER TENERE 23P	1200	10	HF204	487431	HFA4922	513350
XTI200 Z SUPER TENERE ABS 23P, 2BS, BP87	1200	11 - 19	HF204	487431	HFA4922	513350
XTI200 SUPER TENERE ABS	1200	17 - 18	HF204	487431	HFA4922	513350
XTI200 ZE SUPER TENERE ABS 2KB	1200	14 - 19	HF204	487431	HFA4922	513350
XTI200 SUPER TENERE ES	1200	17 - 19	HF204	487431	HFA4922	513350
XTI200 SUPER TENERE WORLDCROSSER	1200	13 - 15	HF204	487431	HFA4922	513350
XTI200 SUPER TENERE ES	1200	16	HF204	487431	HFA4922	513350
FJRI300 5JW	1300	01 - 05	HF148	512962	HFA4912	513340
FJRI300 A ABS 5VS, 3P6, 1CY	1300	03 - 12	HF148	512962	HFA4912	513340
FJRI300 A ABS IMC	1300	13 - 18	HF204	487431	HFA4912	513340
FJRI300 A ABS	1300	19	HF204	487431	HFA4912	513340
FJRI300 AS AUTOMATIC ABS 2D2, 1DA	1300	06 - 11	HF148	512962	HFA4912	513340
FJRI300 AS AUTOMATIC ABS IMD	1300	13 - 18	HF204	487431	HFA4912	513340
FJRI300 AE	1300	09 - 10	HF148	512962	HFA4912	513340
FJRI300 AE 2PD	1300	14 - 18	HF204	487431	HFA4912	513340
FJRI300 AE	1300	19	HF204	487431	HFA4912	513340
FJRI300 ES	1300	15 - 18	HF204	487431	HFA4912	513340
FJRI300 ES	1300	19	HF204	487431	HFA4912	513340
FJRI300 P (USA)	1300	18 - 19	HF204	487431	HFA4912	513340
XJRI300 5EA, 5WM	1300	99 - 06	HF401	512994	HFA4906	513335
XJRI300 5WM	1300	07 - 15	HF401	512994	HFA4920	513348
XJRI300 SP 5EA	1300	99 - 02	HF401	512994	HFA4906	513335
XVSI300 A MIDNIGHT STAR 1IC	1300	07 - 10	HF147	478087	HFA4919	513347
XVSI300 A MIDNIGHT STAR 1CS	1300	11 - 13	HF204	487431	HFA4919	513347
XVSI300 A MIDNIGHT STAR	1300	14 - 15	HF204	487431	HFA4912	513340
XVSI300 A MIDNIGHT STAR CFD	1300	14	HF204	487431	HFA4912	513340
XVSI300 A MIDNIGHT STAR CUSTOM	1300	14 - 15	HF204	487431	HFA4912	513340
XVSI300 A-W, X, Y V-STAR (USA)	1300	07 - 09	HF147	478087	HFA4919	513347
XVSI300 A-A, B, D, E V-STAR (USA)	1300	11 - 15	HF204	487431	HFA4919	513347
XVSI300 C STRYKER IGP, 27D	1300	11 - 17	HF204	487431	HFA4919	513347
XVSI300 CT-W, X, Y V-STAR TOURER (USA)	1300	07 - 09	HF147	478087	HFA4919	513347
XVSI300 CT-Z, A, B, D, E, F, G, H V-STAR TOURER (USA) 5S6C	1300	10 - 17	HF204	487431	HFA4919	513347
XVSI300 CTF-D, E, F, G V, H-STAR DELUXE	1300	13 - 17	HF204	487431	HFA4919	513347
XVZ13 AH, AHC, ATH, ATHC, AT ROYAL STAR 4YP2	1300	96 - 98	HF303	493942	HFA4908	513337
XVZ13 A ROYAL STAR	1300	99 - 02	HF303	493942	HFA4908	513337
XVZ13 TF ROYAL STAR VENTURE (2PCS X HFA4918 REQUIRED) 5JC	1300	00 - 10	HF303	493942	HFA4918	513346
XVZ13 TFS ROYAL STAR VENTURE S (2PCS X HFA4918 RE- 1BM QUIRED)	1300	08 - 13	HF303	493942	HFA4918	513346
XVZ13 TFM ROYAL STAR MIDNIGHT VENTURE (2PCS X HFA4918 REQUIRED)	1300	03 - 07	HF303	493942	HFA4918	513346
XVZ13 TM ROYAL STAR MIDNIGHT TOUR DELUXE (2PCS X HFA4918 REQUIRED)	1300	6	HF303	493942	HFA4918	513346

MOTEUR

CYCLE

PNEUMATIQUE

ATELIER

ACCESSOIRES

ÉLECTRICITÉ

FILTRATION

FREINAGE

TRANSMISSION

Modèle	Cylindrée	Année	HIFLOFILTRO		HIFLOFILTRO	
			Filtre huile Réf. HifloFiltro	Filtre huile Réf. CGN	Filtre air Réf. HifloFiltro	Filtre air Réf. CGN
XVZ13 A ROYAL STAR BOULEVARD	1300	99 - 01	HF303	493942	HFA4908	513337
XVZ13 CT ROYAL STAR TOUR DELUXE (2PCS X HFA4918 REQUIRED)	1300	05 - 09	HF303	493942	HFA4918	513346
XVZ13 CTS ROYAL STAR TOUR DELUXE S (2PCS X HFA4918 REQUIRED)	1300	08 - 10	HF303	493942	HFA4918	513346
XV1600 A ROAD STAR	1600	99 - 03	HF303	493942	HFA4914	513342
XV1600 AT ROAD STAR SILVERADO	1600	99 - 03	HF303	493942	HFA4914	513342
XV1600 ATLE ROAD STAR SILVERADO LIMITED EDITION	1600	3	HF303	493942	HFA4914	513342
XV1600 AS ROAD STAR MIDNIGHT	1600	02 - 03	HF303	493942	HFA4914	513342
XV1600 ALE ROAD STAR LIMITED EDITION	1600	3	HF303	493942	HFA4914	513342
XV1600 A SIVERADO	1600	1	HF303	493942	HFA4914	513342
XV1600 A WILD STAR	1600	00 - 04	HF303	493942	HFA4914	513342
MT-015YU	1700	05 - 11	HF303	493942	-	-
XV1700 PC ROAD STAR WARRIOR	1700	02 - 09	HF303	493942	-	-
XV1700 PC-F ROAD STAR WARRIOR (WITH FLAMES)	1700	06 - 08	HF303	493942	-	-
XV1700 PCM ROAD STAR MIDNIGHT WARRIOR	1700	05 - 09	HF303	493942	-	-
XV1700 A ROAD STAR	1700	04 - 09	HF303	493942	-	-
XV1700 A ROAD STAR S	1700	09 - 15	HF303	493942	-	-
XV1700 A-F ROAD STAR	1700	7	HF303	493942	-	-
XV1700 AM ROAD STAR MIDNIGHT	1700	04 - 07	HF303	493942	-	-
XV1700 AT ROAD STAR SILVERADO	1700	04 - 10	HF303	493942	-	-
XV1700 AT ROAD STAR SILVERADO S	1700	09 - 15	HF303	493942	-	-
XV1700 ATM ROAD STAR MIDNIGHT SILVERADO	1700	7	HF303	493942	-	-
XV1700 ATM ROAD STAR SILVERADO MIDNIGHT EDITION	1700	04 - 06	HF303	493942	-	-
XV1700 AW ROAD STAR CAST WHEELS	1700	05 - 06	HF303	493942	-	-
VMX1700 V-MAX 2S3, 2CE	1700	09 - 20	HF303	493942	-	-
XV1900 ROADLINER	1900	06 - 10	HF303	493942	-	-
XV1900 M ROADLINER MIDNIGHT	1900	06 - 09	HF303	493942	-	-
XV1900 S ROADLINER	1900	06 - 10	HF303	493942	-	-
XV1900 S ROADLINER	1900	12 - 14	HF204	487431	-	-
XV1900 B STAR ELUDER	1900	18	HF204	487431	-	-
XV1900 C RAIDER	1900	08 - 10	HF303	493942	-	-
XV1900 C RAIDER	1900	11 - 17	HF204	487431	-	-
XV1900 C RAIDER S	1900	09 - 10	HF303	493942	-	-
XV1900 C RAIDER S	1900	11 - 15	HF204	487431	-	-
XV1900 C RAIDER SL	1900	12	HF204	487431	-	-
XV1900 RAIDER BULLET COWL	1900	15	HF204	487431	-	-
XV1900 CT STRATOLINER	1900	06 - 10	HF303	493942	-	-
XV1900 CT STRATOLINER DELUXE	1900	11 - 13	HF204	487431	-	-
XV1900 CTF STRATOLINER DELUXE	1900	14	HF204	487431	-	-
XV1900 CTM STRATOLINER MIDNIGHT	1900	06 - 08	HF303	493942	-	-
XV1900 CTS STRATOLINER S	1900	06 - 10	HF303	493942	-	-

Modèle	Cylindrée	Année	H.FLOFILTRO		H.FLOFILTRO	
			Filtre huile Réf. HilfoFiltro	Filtre huile Réf. CGN	Filtre air Réf. HilfoFiltro	Filtre air Réf. CGN
XV1900 CTS STRATOLINER S	1900	12 - 15	HF204	487431	-	-
XV1900 A MIDNIGHT STAR 5C4	1900	06 - 10	HF303	493942	-	-
XV1900 A MIDNIGHT STAR 1CR	1900	11 - 15	HF204	487431	-	-
XV1900 F-J, K, L STAR VENTURE	1900	18 - 20	HF204	487431	-	-
YTM200 K, L, N (TRI MOTO)	200	83 - 85	HF143	450791	-	-
YTM200 EK, EL, ERN (TRI MOTO)	200	83 - 85	HF143	450791	-	-
YTM225 DXK, DXL, DXN, DRS (TRI MOTO)	225	83 - 86	HF143	450791	-	-
YTM225 DRN, DRS	225	85 - 86	HF143	450791	-	-
YFA125 W, B, D, E, F, G, H, J, K, L, M, N, P, R, S BREEZE	125	89 - 04	-	-	HFF4015	513465
YFM125 T, V GRIZZLY	125	05 - 06	-	-	HFF4015	513465
YFM200 N	200	85 - 89	HF143	450791	-	-
YFM200 DXS, DXW	200	86 - 87	HF143	450791	-	-
YFS200 U, W, A, B, D, E, F, G, H, J, K, L, M, N, P, R, S, T, V BLASTER	200	88 - 06	-	-	HFF4015	513465
YFM225 S, T, U	225	86 - 90	HF143	450791	-	-
YFM230 BEARTRACKER	230	03 - 04	HF143	450791	-	-
YFB250 D, G	250	92 - 95	HF143	450791	-	-
YFB250 F, FWF/G/H/K, H, UH, J, UJ, UK TIMBERWOLF	250	94 - 99	HF143	450791	-	-
YFB250 FW TIMBERWOLF	250	0	HF143	450791	-	-
YFM250 W	250	89 - 92	HF143	450791	-	-
YFM250 ERW, ERA, D	250	89 - 93	HF143	450791	-	-
YFM250 BEAR TRACKER	250	91 - 04	HF143	450791	-	-
YFM250 BRUIN (FOAM AIR FILTER OUTER COVER)	250	6	HF143	450791	HFF4029	513479
YFM250 W, X, Y BIG BEAR (FOAM AIR FILTER OUTER COVER)	250	07 - 09	HF143	450791	HFF4029	513479
YFM250 R-X, Y, Z, A, B, D RAPTOR	250	08 - 13	HF140	512958	HFF4027	513477
YFM250 RSE-X, Y RAPTOR SE	250	08 - 09	HF140	512958	HFF4027	513477
YFM250 RSE2-Y RAPTOR SE2	250	9	HF140	512958	HFF4027	513477
YFM250 RSP-A RAPTOR SE	250	11	HF140	512958	HFF4027	513477
YFM250 R RAPTOR SE CUSTOM	250	8	HF140	512958	HFF4027	513477
YFM350 XT, XU WARRIOR	350	87 - 88	HF142	512959	-	-
YFM350 ERT, ERU	350	87 - 88	HF142	512959	-	-
YFM350 FW-T, U, W, F, J, BJ BIG BEAR	350	87 - 99	HF142	512959	-	-
YFM350 FW-A, B, D, E, F, G	350	90 - 95	HF142	512959	-	-
YFM350 UH	350	96	HF142	512959	-	-
YFM350 BA-S, T, V BRUIN AUTOMATIC 2WD (FOAM AIR FILTER OUTER COVER)	350	04 - 06	HF303	493942	HFF4028	513478
YFM350 FA-S, T, V BRUIN AUTOMATIC 4X4 (FOAM AIR FILTER OUTER COVER)	350	04 - 06	HF303	493942	HFF4028	513478
YFM350 FAH-T, V BRUIN HUNTER 4X4 (FOAM AIR FILTER OUTER COVER)	350	05 - 06	HF303	493942	HFF4028	513478
YFM350 FX-H, J, K, L, M, N, P, R, S, T WOLVERINE 4X4	350	96 - 05	HF142	512959	HFF4024	513474
YFM350 X-V, W, X, Y WOLVERINE 2WD	350	06 - 09	HF204	487431	HFF4024	513474

MOTEUR

CYCLE

PNEUMATIQUE

ATELIER

ACCESSOIRES

ÉLECTRICITÉ

FILTRATION

FREINAGE

TRANSMISSION

Modèle	Cylindrée	Année	HIFLOFILTRO		HIFLOFILTRO	
			Filtre huile Réf. HifloFiltro	Filtre huile Réf. CGN	Filtre air Réf. HifloFiltro	Filtre air Réf. CGN
YFM350 X- W, B, D, E, F, G, H, J, L, M, N, P, R, S WARRIOR	350	89 - 04	HF142	512959	HFF4024	513474
YFM350 X-W, X WOLVERINE SPORT (2WD) (FOAM AIR FILTER OUTER COVER)	350	07 - 08	HF204	487431	HFF4028	513478
YFM350 R-T, V, W, X, Y, Z, A, B, D RAPTOR	350	05 - 13	HF142	512959	HFF4024	513474
YFM350 RSE-W RAPTOR SPECIAL EDITION	350	7	HF142	512959	HFF4024	513474
YFM350 RSE2-W RAPTOR SPECIAL EDITION 2	350	7	HF142	512959	HFF4024	513474
YFM350 G-W, X, Z, A GRIZZLY (2WD) (FOAM AIR FILTER OUTER COVER)	350	07 - 11	HF204	487431	HFF4028	513478
YFM350 T-E GRIZZLY (2WD) (FOAM AIR FILTER OUTER COVER)	350	14	HF204	487431	HFF4028	513478
YFM350 FG-W, X, Y, Z, A, B, D, E GRIZZLY (4WD) (FOAM AIR FILTER OUTER COVER)	350	07 - 14	HF204	487431	HFF4028	513478
YFM350 FGI-W, X, Y, Z, A GRIZZLY IRS (FOAM AIR FILTER OUTER COVER)	350	07 - 11	HF204	487431	HFF4028	513478
YFM350 FGIH-W, X, Y, Z, A, B, D GRIZZLY IRS HUNTER (FOAM AIR FILTER OUTER COVER)	350	07 - 14	HF204	487431	HFF4028	513478
YFP350 T, U TERRAPRO	350	88	HF142	512959	-	-
YFZ350 T, U, W, A, B, D, E, F, G, H, J, K, L, M, N, P, R, S, T, V BANSHEE	350	87 - 06	-	-	HFF4021	513471
YFM400 FWF, FWG, FWH, FWK KODIAK	400	94 - 99	HF142	512959	-	-
YFM400 FA KODIAK 400 AUTOMATIC 4X4 (FOAM AIR FILTER OUTER COVER)	400	00 - 06	HF303	493942	HFF4028	513478
YFM400 BIG BEAR	400	93 - 02	HF142	512959	-	-
YFM400 N, S BIG BEAR 2WD (FOAM AIR FILTER OUTER COVER)	400	03 - 04	HF142	512959	HFF4029	513479
YFM400 FW BIG BEAR 4X4 (FOAM AIR FILTER OUTER COVER)	400	03 - 06	HF142	512959	HFF4029	513479
YFM400 F-W GRIZZLY (FOAM AIR FILTER OUTER COVER)	400	7	HF204	487431	HFF4028	513478
YFM400 FGH-W GRIZZLY HUNTER (FOAM AIR FILTER OUTER COVER)	400	7	HF204	487431	HFF4028	513478
YFM400 FB-W, X, Y, Z, A, B BIG BEAR IRS (FOAM AIR FILTER 4SI OUTER COVER)	400	07 - 12	HF142	512959	HFF4029	513479
YFM400 FBH-W, X, Y, Z, A, B BIG BEAR HUNTER IRS (FOAM AIR 4SI FILTER OUTER COVER)	400	07 - 12	HF142	512959	HFF4029	513479
YFM450 FA KODIAK 450 4WD (FOAM AIR FILTER OUTER COVER)	450	03 - 06	HF303	493942	HFF4028	513478
YFM450 FAH KODIAK 450 4WD HUNTER (FOAM AIR FILTER OUTER COVER)	450	03 - 05	HF303	493942	HFF4028	513478
YFM450 KDX-J, K KODIAK 4WD	450	18 - 19	HF204	487431	-	-
YFM450 KDX-L KODIAK 450	450	20	HF204	487431	-	-
YFM450 KDH-J, K KODIAK 4WD HUNTER	450	18 - 19	HF204	487431	-	-
YFM450 KDH-L KODIAK 450 HUNTER	450	20	HF204	487431	-	-
YFM450 KPX-J, K KODIAK EPS	450	18 - 19	HF204	487431	-	-
YFM450 KPL-K KODIAK EPS	450	19	HF204	487431	-	-
YFM450 KPA-J KODIAK EPS	450	18	HF204	487431	-	-
YFM450 KPA-L KODIAK 450 EPS	450	20	HF204	487431	-	-
YFM450 KPH-K KODIAK EPS	450	19	HF204	487431	-	-

Modèle	Cylindrée	Année	HIFLOFILTRO		HIFLOFILTRO	
			Filtre huile Réf. HifloFiltro	Filtre huile Réf. CGN	Filtre air Réf. HifloFiltro	Filtre air Réf. CGN
YFM450 KPH-L KODIAK 450 EPS HUNTER	450	20	HF204	487431	-	-
YFM450 KPS-L KODIAK 450 EPS SE	450	20	HF204	487431	-	-
YFM450 WOLVERINE 4X4 (FOAM AIR FILTER OUTER COVER)	450	6	HF303	493942	HFF4028	513478
YFM450 FX-W, X, Z WOLVERINE 4X4 SPORT (FOAM AIR FILTER OUTER COVER)	450	07 - 10	HF204	487431	HFF4028	513478
YFM450 FX WOLVERINE SPORT SPECIAL EDITION (FOAM AIR FILTER OUTER COVER)	450	7	HF204	487431	HFF4028	513478
YFM450 FG-W, X, Y, Z, A, B, D, E GRIZZLY (FOAM AIR FILTER OUTER COVER)	450	07 - 14	HF204	487431	HFF4028	513478
YFM450 FGOH GRIZZLY OUTDOORSMAN EDITION (FOAM AIR FILTER OUTER COVER)	450	7	HF204	487431	HFF4028	513478
YFM450 FGH-W, X, Y, A, B, D GRIZZLY HUNTER (FOAM AIR FILTER OUTER COVER)	450	07 - 13	HF204	487431	HFF4028	513478
YFM450 FGP-A, B, D, E GRIZZLY EPS (FOAM AIR FILTER OUTER COVER)	450	11 - 14	HF204	487431	HFF4028	513478
YFM450 FGPH-A, B, D, E GRIZZLY EPS HUNTER (FOAM AIR FILTER OUTER COVER)	450	11 - 14	HF204	487431	HFF4028	513478
YFM450 DA-E GRIZZLY 450 HUNTING (FOAM AIR FILTER OUTER COVER)	450	14	HF204	487431	HFF4028	513478
YFZ450 S, T, V	450	04 - 06	HF141	494343	HFF4022	513472
YFZ450 W, X, Y, Z, A, B, D	450	07 - 13	HF140	512958	HFF4022	513472
YFZ450 R-Y, Z, A, B, D, E, F, G, H, J, K	450	09 - 19	HF140	512958	HFF4022	513472
YFZ450 YSXL-L YFZ450R	450	20	HF140	512958	HFF4022	513472
YFZ450 RSE-W, X, Y, Z, A, B, D, E, F, G, H, J, K SPECIAL EDITION	450	07 - 19	HF140	512958	HFF4022	513472
YFZ450 YSS-LM/R YFZ450R SPECIAL EDITION	450	20	HF140	512958	HFF4022	513472
YFZ450 X-Z, A	450	10 - 11	HF140	512958	HFF4022	513472
YFZ450 XSE-A SE	450	11	HF140	512958	HFF4022	513472
YFZ450 XBB-Z BILL BALLANCE EDITION	450	10	HF140	512958	HFF4022	513472
YFZ450 SE2-W SPECIAL EDITION2	450	7	HF140	512958	HFF4022	513472
YFZ450 BB-W BILL BALLANCE EDITION	450	7	HF140	512958	HFF4022	513472
YFM550 FG-Y, Z, A, B, D, E GRIZZLY FI AUTO 4X4	550	09 - 14	HF204	487431	HFF4026	513476
YFM550 FGH-Y, Z, A, B, D, E GRIZZLY HUNTER FI AUTO 4X4 EPS	550	09 - 14	HF204	487431	HFF4026	513476
YFM550 FGP-Y, Z, A, B GRIZZLY FI AUTO 4X4 EPS	550	09 - 12	HF204	487431	HFF4026	513476
YFM550 FGPH-Y, Z, A GRIZZLY HUNTER FI AUTO 4X4 EPS	550	09 - 11	HF204	487431	HFF4026	513476
YFM550 FGPSE-Y GRIZZLY FI AUTO 4X4 EPS SE	550	9	HF204	487431	HFF4026	513476
YFM600 FWAK GRIZZLY	600	98 - 01	HF145	487430	HFF4024	513474
YFM660 R-N, P, R, S, T RAPTOR	660	01 - 05	HF147	478087	-	-
YFM660 RLE-R, S RAPTOR BLACK LIMITED EDITION	660	03 - 04	HF147	478087	-	-
YFM660 F-P, R, S, T, V GRIZZLY 4X4 AUTOMATIC	660	02 - 06	HF303	493942	HFF4024	513474

Modèle	Cylindrée	Année	HIFLOFILTRO		HIFLOFILTRO	
			Filtre huile Réf. HifloFiltro	Filtre huile Réf. CGN	Filtre air Réf. HifloFiltro	Filtre air Réf. CGN
YFM660 F-W, X GRIZZLY 4 X 4	660	07 - 08	HF204	487431	HFF4024	513474
YFM660 FR-C GRIZZLY 660 LIMITED	660	3	HF303	493942	HFF4024	513474
YFM660 FHR GRIZZLY 660 4X4 WETLANDS HUNTER EDITION	660	3	HF303	493942	HFF4024	513474
YFM660 FHS GRIZZLY 660 4X4 HARDWOODS HUNTER CAMO	660	4	HF303	493942	HFF4024	513474
YFM660 F-W, X GRIZZLY HUNTER	660	07 - 08	HF204	487431	HFF4024	513474
YFM700 FG-W, X, Y, Z, A, B, D GRIZZLY	700	07 - 13	HF204	487431	HFF4026	513476
YFM700 D-E, F, G, H GRIZZLY	700	14 - 16	HF204	487431	HFF4026	513476
YFM700 FGH-W, X, Y, Z, A, B, D GRIZZLY HUNTER	700	07 - 13	HF204	487431	HFF4026	513476
YFM700 DH-E, F GRIZZLY HUNTER	700	14 - 15	HF204	487431	HFF4026	513476
YFM700 DH-G GRIZZLY HUNTER	700	16	HF147	478087	-	-
YFM700 FGP-Z, A, B, D GRIZZLY 4WD FI EPS	700	10 - 13	HF204	487431	HFF4026	513476
YFM700 P-E, F GRIZZLY 4WD FI EPS	700	14 - 15	HF204	487431	HFF4026	513476
YFM700 P-G GRIZZLY 4WD FI EPS	700	16	HF147	478087	-	-
YFM700 FGPDU-W, X, Y GRIZZLY DUCKS UNLIMITED EDITION	700	07 - 09	HF204	487431	HFF4026	513476
YFM700 FGPH-Z, A, B, D GRIZZLY HUNTER EPS	700	10 - 13	HF204	487431	-	-
YFM700 PH-E, F GRIZZLY HUNTER EPS	700	14 - 15	HF204	487431	HFF4026	513476
YFM700 PH-G GRIZZLY HUNTER EPS	700	16	HF147	478087	HFF4026	513476
YFM700 FGPSE-W, X, Y, Z, A, B, D GRIZZLY SPECIAL EDITION (POWER STEERING)	700	07 - 13	HF204	487431	HFF4026	513476
YFM700 PSE-E GRIZZLY SPECIAL EDITION (POWER STEERING)	700	14	HF204	487431	HFF4026	513476
YFM700 FGPPS-A, B GRIZZLY EPS SPECIAL EDITION	700	11 - 12	HF204	487431	HFF4026	513476
YFM700 GPA-J GRIZZLY EPS	700	18	HF147	478087	-	-
YFM700 GPA-K GRIZZLY EPS	700	19	HF204	487431	-	-
YFM700 GPA-L GRIZZLY EPS	700	20	HF204	487431	-	-
YFM700 GPH-J GRIZZLY EPS HUNTER	700	18	HF147	478087	-	-
YFM700 GPH-K GRIZZLY EPS HUNTER	700	19	HF204	487431	-	-
YFM700 GPH-L GRIZZLY EPS HUNTER	700	20	HF204	487431	-	-
YFM700 GPL-H, J GRIZZLY EPS 4WD LE	700	17 - 18	HF147	478087	-	-
YFM700 GPL-K GRIZZLY EPS 4WD LE	700	19	HF204	487431	-	-
YFM700 GPS-H, J GRIZZLY EPS 4WD SE	700	17 - 18	HF147	478087	-	-
YFM700 GPS-K GRIZZLY EPS 4WD SE	700	19	HF204	487431	-	-
YFM700 GPS-L GRIZZLY EPS SPECIAL	700	20	HF204	487431	-	-
YFM700 GPX-J GRIZZLY EPS	700	18	HF147	478087	-	-
YFM700 KDH-G, H, J KODIAK 700 4WD HUNTER	700	16 - 18	HF147	478087	-	-
YFM700 KDH-K KODIAK 700 4WD HUNTER	700	19	HF204	487431	-	-
YFM700 KDX-J KODIAK 700	700	18	HF147	478087	-	-
YFM700 KDX-K KODIAK 700	700	19	HF204	487431	-	-
YFM700 KPA-H, J KODIAK 700 4WD EPS HUNTER	700	17 - 18	HF147	478087	-	-

Modèle	Cylindrée	Année	HIFLOFILTRO		HIFLOFILTRO	
			Filtre huile Réf. HilfoFiltro	Filtre huile Réf. CGN	Filtre air Réf. HilfoFiltro	Filtre air Réf. CGN
YFM700 KPA-K KODIAK 700 4WD EPS HUNTER	700	19	HF204	487431	-	-
YFM700 KPH-G, H, J KODIAK 700 4WD EPS HUNTER	700	16 - 18	HF147	478087	-	-
YFM700 KPH-K KODIAK 700 4WD EPS HUNTER	700	19	HF204	487431	-	-
YFM700 KPL-K KODIAK 700 4WD EPS HUNTER	700	19	HF204	487431	-	-
YFM700 KPX-G, H, J KODIAK 700 4WD EPS	700	16 - 18	HF147	478087	-	-
YFM700 KPX-K KODIAK 700 4WD EPS	700	19	HF204	487431	-	-
YFM700 KPS-G, H, J KODIAK 700 4WD EPS SE	700	16 - 18	HF147	478087	-	-
YFM700 KPS-K KODIAK 700 4WD EPS SE	700	19	HF204	487431	-	-
YFM700 R-V, W, X, Y, Z, A, B, D, E, F, G RAPTOR IAS	700	06 - 16	HF145	487430	HFF4025	513475
YFM700 RSE/RSE2 - W, X, Y, Z, A, B, D, E, F, G, H, J RAPTOR SPECIAL EDITION	700	09 - 18	HF145	487430	HFF4025	513475
YFM700 RSS-K RAPTOR 700R SE	700	19	HF145	487430	HFF4025	513475
YFM700 RSS-L RAPTOR 700R SE	700	20	HF145	487430	HFF4025	513475
YFM700 RSB-H, J, K RAPTOR	700	17 - 19	HF145	487430	HFF4025	513475
YFM700 RSB-L RAPTOR 700	700	20	HF145	487430	HFF4025	513475
YFM700 RSX-H, J, K RAPTOR R	700	17 - 19	HF145	487430	HFF4025	513475
YFM700 RSC-L RAPTOR 700R	700	20	HF145	487430	HFF4025	513475
YFM700 RSP-W, X RAPTOR SPECIAL EDITION	700	07 - 08	HF145	487430	HFF4025	513475
YFM700 R RAPTOR GYTR EDITION	700	7	HF145	487430	HFF4025	513475
YXR450 RHINO AUTO 4X4	450	06 - 09	HF303	493942	-	-
YXR660 RHINO	660	04 - 06	HF303	493942	-	-
YXR660 RHINO HARDWOOD CAMO.	660	04 - 05	HF303	493942	-	-
YXR660 RHINO EXPLORING EDITION / SPECIAL EDITION	660	6	HF303	493942	-	-
YXC700 VDX-F, G, H, J VI VIKING	700	15 - 18	HF204	487431	-	-
YXC700 VPA-J VI VIKING EPS	700	18	HF204	487431	-	-
YXC700 VPX-F, G, H, J VI VIKING EPS	700	15 - 18	HF204	487431	-	-
YXC700 VPX-K VI VIKING EPS	700	19	HF204	487431	-	-
YXC700 VPS-F, G, H VI VIKING EPS SE	700	15 - 17	HF204	487431	-	-
YXC700 VPH-F, G, H, J VI VIKING HUNTER EPS	700	15 - 18	HF204	487431	-	-
YXC700 VPH-K VI VIKING HUNTER EPS	700	19	HF204	487431	-	-
YXE700 WDB-J WOLVERINE R-SPEC	700	18	HF204	487431	-	-
YXE700 WDH-G WOLVERINE R-SPEC HUNTER	700	16	HF204	487431	-	-
YXE700 WDX-G WOLVERINE R-SPEC	700	16	HF204	487431	-	-
YXE700 WPA-J WOLVERINE R-SPEC	700	18	HF204	487431	-	-
YXE700 WPH-G, H, J WOLVERINE R-SPEC EPS HUNTER	700	16 - 18	HF204	487431	-	-
YXE700 WPX-G, H WOLVERINE R-SPEC EPS	700	16 - 17	HF204	487431	-	-
YXM700 VDX-F, G, H, J VIKING	700	15 - 18	HF204	487431	-	-

MOTEUR

CYCLE

PNEUMATIQUE

ATELIER

ACCESSOIRES

ÉLECTRICITÉ

FILTRATION

FREINAGE

TRANSMISSION



/ DISQUES DE FREIN / BRAKE DISKS

862

**/ PLAQUETTES DE FREIN - MÂCHOIRES DE FREIN /
BRAKE PADS - BRAKE SHOE**

874





Modèle	Cylindrée	Année	Avant	Arrière
ADLY				
SUPER SONIC ALL MODELS	125	01 - 05	440745	
THUNDER BIKE	125	16	440745	
THUNDER BIKE	125	99 - 15	440745	
APRILIA				
DIETCH	125	99 - 05	465366	
HABANA - CUSTOM	125	99 - 02	465366	
MOJITO - MOJITO RETRO	125	99 - 08	465366	
RS4 - RS4 REPLICIA	125	11 - 17	485125	
SPORTCITY ONE	125	08 - 11	518051	
SPORTCITY SR	125	08 - 11	518051	
SR	125	99 - 03	277093	277093
SR - SR SPORTER	125	99 - 03	465366	
SR MAX I	125	10 - 17	483311	495192
SR MOTARD	125	12 - 17	518051	
SR REAR DRUM BRAKE	125	99 - 03	277093	
SR REPLICIA	125	99 - 01	277093	277093
MOJITO	150	03 - 04	440745	
SR	150	99 - 03	277093	
SR R	150	99 - 03	465366	
SR MAX I	300	10 - 17	483311	495192
BEELINE				
VELOCE - VELOCE GT	125	08 - 10	440745	
BENELLI				
ADIVA 12"	125	00	518051	
ADIVA 12"	150	00	518051	
BETA				
EIKON	125	99 - 06	518051	478565
EIKON	150	00 - 06	518051	478565
BSM				
TB	125	-	440745	440745
CPI				
OLIVER CITY	125	06 - 07	440745	
DAELIM				
AROMA	125	16	440745	
BESBI	125	11 - 12	440745	
DERBI				
BOULEVARD	125	02 - 10	518051	
DRD R - DRD R SM	125	06	485542	
GPR R 2T - GPR R 4T	125	05 - 11	485125	485124
GPR R 4T - GPR 4T 4V	125	09 - 12	485125	
MULHACEN CAFÉ	125	07 - 12	485125	
PREDATOR	125	99 - 02	518051	
SENDA BAJA 4T SM	125	07 - 13	518199	



Modèle	Cylindrée	Année	Avant	Arrière
SENDA BAJA 4T SM	125	07 - 13	483293	
SENDA R DRD DEVIL 4T	125	04 - 05	485542	
SENDA SM 4T	125	04 - 06	518199	
TERRA ADVENTURE	125	07 - 13	518199	
TERRA ADVENTURE	125	07 - 13	483293	
VARIANT SPORT 4T	125	14 - 17	518051	
BOULEVARD	150	03 - 05	518051	
PREDATOR	180	99 - 02	518051	
BOULEVARD	200	03 - 05	518051	
EZI				
BLUE SHARK RI LITE HS 80 KM - H	E	22	521380	
BLUE SHARK RI LITE LS 45 KM - H	E	22	521380	
BLUE SHARK RI PRO 2-HS 80 KM - H	E	22	521380	
BLUE SHARK RI PRO 2-LS 45 KM - H	E	22	521380	
CITI 2-HS 80 KM - H	E	22	521380	
CITI 2-LS 25 KM - H	E	22	521380	
CITI 3	E	22	521380	
GARELLI				
FREELAND	125	ALL	440745	
FREELAND	150	ALL	440745	
GENERIC				
IDEO - XOR	125	05 - 11	440742	
SIRION 4T	125	12 - 14	440742	
GILERA				
COGUAR	125	99	483311	
DNA	125	00 - 03	495192	495192
NEXUS - NEXUS I.E.	125	07 - 15	483311	495192
RUNNER	125	06 - 08	518051	
RUNNER FX - FX SP - SP	125	97 - 05	518051	
RUNNER VX	125	00 - 05	518051	
SCUADRA CORSE	125	06	485125	485124
SKIPPER LX	125	98 - 99	518051	
SKR ST 4T	125	00	518051	
TYPHOON	125	95 - 00	277093	
TYPHOON 4T	125	11	518051	
SKIPPER LX	150	98 - 99	518051	
SKR ST 4T	150	00	518051	
DNA	180	00 - 03	495192	495192
RUNNER FXR	180	98 - 05	518051	
RUNNER FXR SP	180	99 - 00	518051	
RUNNER SP	180	99 - 05	518051	
RUNNER VXR	180	00 - 04	518051	
HERCULES	200	02	518051	
RUNNER SP	200	01 - 02	518051	

MOTEUR

CYCLE

PNEUMATIQUE

ATELIER

ACCESSOIRES

ÉLECTRICITÉ

FILTRATION

FREINAGE

TRANSMISSION



Modèle	Cylindrée	Année	Avant	Arrière
RUNNER VX - VXR 4T	200	02	518051	
NEXUS	250	06 - 08	495192	495192
NEXUS I.E. - HENGTONG	300	08	495192	495192
NEXUS - I.E. SP	500	04 - 15	483311	495192
HONDA				
@ NES	125	09	483786	483787
PANTHEON FES 2T	125	98 - 02	483786	
PANTHEON FES 4T	125	98 - 07	483786	
S-WING - S-WING ABS	125	07 - 11	483786	
SH I - SH I CBS SCOOPY	125	09 - 18	483786	483787
SH I SCOOPY ABS	125	19 - 22	483786	483787
SH I SPORT SCOOPY	125	09 - 17	483786	483787
SJ BALI - SPACY - SPACY CHA	125	96	440745	
@ NES	150	09	483786	483787
PHANTHEON FES 2T	150	98 - 04	483786	
PHANTHEON FES 4T	150	03 - 07	483786	
S-WIN FES	150	07	483786	
S-WING	150	08 - 09	483786	
SH I - SH I ABS SCOOPY	150	05 - 20	483786	483787
SH I GT SCOOPY	150	12	483786	483787
SH I SPORTY SCOOPY	150	09 - 11	483786	483787
CB TWO FIFTY	250	91 - 06	483786	
FORESIGHT FES	250	97 - 98	483786	
FORESIGHT FES	250	99 - 07	483786	
FORZA NSS	250	00 - 04	483786	
FORZA X NSS - XE NSS	250	05 - 07	483786	483787
JAZZ	250	01 - 04	483786	
PANTHEON	250	98	483786	
VT C V TWIN MAGNA S	250	95 - 97	518051	
KEEWAY				
E-ZI PLUS	E	19	277093	
EFI - RE-EVOLUTION	125	08 - 12	483786	483786
LOGIK	125	08 - 12	483786	483786
LOGIK I 4T EFI CBS	125	13 - 19	483786	
ZAHARA F: 12" - R: 10"	125	15 - 21	277093	
ZAHARA F: 12" - R: 13"	125	22	277093	
OUTLOOK	150	07	483786	483786
KL				
NOX - PROXY - PULSAR	125	00 - 01	465366	
NOX - PROXY - PULSAR	150	00 - 01	465366	
KSR				
EPICO	E	12 - 13	440745	
RUMBLER	125	13 - 14	440745	
SIRION 4T	125	02 - 14	440745	

MOTEUR
CYCLE
PNEUMATIQUE
ATELIER
ACCESSOIRES
ÉLECTRICITÉ
FILTRATION
FREINAGE
TRANSMISSION



Modèle	Cylindrée	Année	Avant	Arrière
XOR	125	05 - 11	440745	
MALAGUTI				
MADISON NON ABS ANNIVERSARY EDITION	300	19 - 21	483311	495192
MADISON NON ABS	300	19 - 21	483311	495192
MASH				
SIXTY FIVE	125	13 - 15	440745	
MBK				
DOODO	125	00 - 02	477499	
SKYCRUISER	125	06 - 10	521375	483306
SKYCRUISER ABS	125	11	521375	483306
SKYLINER DD	125	04 - 10	477499	
SKYLINER DD	125	99 - 03	477499	483307
SKYLINER DT	125	98 - 00	477499	
WAAP	125	08 - 11	320158	
DOODO	150	00 - 02	477499	
SKYLINER	150	98 - 10	477499	
SKYLINER R	150	01	477499	483307
SKYLINER YP DD	150	01 - 02	477499	483307
SKYLINER YP DT	150	00 - 01	477499	
SKYLINER YP E	180	03	477499	483307
SKYLINER	400	04 - 06	521375	
MEGELLI				
R	125	05 - 09	485125	485124
MH				
ARENA ENDURO	125	05	465374	483294
DUNA	125	12 - 13	465374	483294
DUNA HARD ROAD ECO	125	10	465374	483294
KN2 L.C. - MH7 L.C.	125	12 - 13	483297	
MH10 PRO L.C. SM	125	12 - 13	483297	
MH7 NAKED	125	07 - 13	483297	
RX R	125	07 - 13	483297	
MH7 L.C.	250	12 - 13	483297	
MOTO ROMA				
GRAND PRIX	50-100	99 - 03	440745	
GRAND PRIX	125	02	440745	
NIU				
MQI GT 14"	E	21 - 23	521380	
MQI GT EVO 14"	E	21 - 23	521380	
MQI GT L3 F - R: 14"	E	21 - 22	521380	
NIS F - R: 12"	E	21	521380	
NIS SHARING F - R: 12"	E	21 - 22	521380	
NQI - SERIES	E	19 - 20	521380	
NQI CARGO XR	E	19 - 22	521380	
NQI GT CARGO	E	19 - 23	521380	



Modèle	Cylindrée	Année	Avant	Arrière
NQI GT CBS 12"	E	18 - 20	521380	
NQI GTS CBS 14"	E	21 - 23	521380	
NQI GTS SPORT	E	19 - 20	521380	
NQI LITE EBS F - R: 12"	E	20 - 22	521380	
NQI SHARING	E	19 - 20	521380	
NQI SPORT CBS 12"	E	21 - 23	521380	
NS SPORT	E	18 - 20	521380	
UQI GT CBS 14"	E	23	521380	
PEUGEOT				
AVENUE	125	04 - 13	483313	483314
DJANGO ABS 12"	125	12 - 22	521379	
DJANGO ALLURE - EVASION - ABS	125	12 - 19	521379	
DJANGO BRIGHT ABS 12"	125	22	521379	
DJANGO DARK 12"	125	22	521379	
DJANGO HERITAGE	125	14 - 19	521379	
DJANGO ID - ABS	125	15 - 19	521379	
DJANGO RACING GREEN ABS	125	21	521379	
DJANGO SHADOW E5 ABS 12"	125	22	521379	
DJANGO SPORT - ABS	125	15 - 22	521379	
ELYSTAR ADVANTAGE	125	01 - 03	485545	
EXECUTIVE	125	94	440742	
GEOPOLIS - GEOPOLIS RS	125	07 - 13	483313	
GEOPOLIS CITY	125	08 - 12	483313	
GEOPOLIS CITY - PREMIUM	125	06 - 07	483313	
GEOPOLIS EXECUTIVE	125	08 - 12	483313	
GEOPOLIS EXECUTIVE ABS	125	06 - 10	483313	
GEOPOLIS PREMIUM	125	08 - 12	483313	
LUDIX	125	04	277093	277093
LUDIX 14"	E	19 - 22	440742	
SATELIS - SATELIS ABS	125	06 - 19	483313	483314
SATELIS 4V EXECUTIVE	125	06 - 09	483313	483314
SATELIS BLACK EDITION - ABS	125	17 - 19	483313	483314
SATELIS COMPRESSOR	125	06 - 13	483313	483314
SATELIS II - II ABS	125	06 - 16	483313	483314
SATELIS K BLACK - WHITESAT	125	08 - 11	483313	483314
SATELIS PREMIUM - RS - URBAN	125	14 - 17	483313	483314
SATELIS RS	125	04 - 18	483313	483314
SPEEDFIGHT 4 I	125	17	498903	
SPEEDFIGHT 4 I R-CUP SBC 13"	125	18 - 20	498903	
SPEEDFIGHT 4 SBC 13"	125	14 - 20	498903	
SPEEDFIGHT 4 SPORTLINE 13"	125	20 - 21	498903	
SPEEDFLIGHT 13"	125	20 - 21	498903	
SV GEO	125	91 - 95	440742	
VIVA 3	125	12	521379	



Modèle	Cylindrée	Année	Avant	Arrière
DJANGO	150	15	521379	
DJANGO ACTIVE - ALLURE	150	14 - 18	521379	
DJANGO EVASION - SPORT	150	14 - 17	521379	
DJANGO HERITAGE	150	14	521379	
DJANGO ID	150	15 - 18	521379	
LOOXOR	150	02 - 04	277093	277093
GÉOPOLIS CITY	200	06 - 09	483313	
GÉOPOLIS EXECUTIVE	200	06 - 09	483313	
GÉOPOLIS	250	06 - 11	483313	
GÉOPOLIS EXECUTIVE - RS - URBAN	250	06 - 11	483313	
GÉOPOLIS PREMIUM	250	06 - 11	483313	
SATELIS	250	06 - 13	483313	
SATELIS PREMIUM - RS	250	08 - 09	483313	
SV	250	01 - 07	483786	
GÉOPOLIS - GEOPLIS RS	300	10 - 13	483313	
GÉOPOLIS - SATELIS - GT	300	14	483313	
GÉOPOLIS PREMIUM	300	10 - 14	483313	
GEOSTYLE	300	10 - 15	483313	
SATELIS I F:14" - R:13"	300	12 - 17	483313	
SATELIS PREMIUM	300	13 - 17	483313	
GÉOPOLIS	400	07 - 09	483313	
GÉOPOLIS GT	400	14	483313	
GÉOPOLIS PREMIUM - RS	400	07 - 12	483313	
GÉOPOLIS URBAN - ABS	400	07 - 13	483313	
METROPOLIS 120 ANS 13" - 14"	400	19	521377	521382
METROPOLIS ABS F:13" - R:14"	400	21	521377	521382
METROPOLIS ACCESS SBC 12" - 14"	400	18 - 20	521378	521382
METROPOLIS ACTIVE ABS F:13" - R:14"	400	15 - 22	521377	521382
METROPOLIS ALLURE - RS F:12" - R:14"	400	15 - 17	521378	521382
METROPOLIS ALLURE ABS F:13" - R:14"	400	18 - 22	521377	521382
METROPOLIS BLACK EDITION ABS 13" - 14"	400	19 - 20	521377	521382
METROPOLIS GT ABS F:13" - R:14"	400	22	521377	521382
METROPOLIS GTI - I - I SPORT F:12" - R:14"	400	14	521378	521382
METROPOLIS RD F:13" - R:14"	400	17	521377	521382
METROPOLIS RS ABS F:13" - R:14"	400	17 - 20	521377	521382
METROPOLIS RS F:12" - R:14"	400	14 - 15	521378	521382
METROPOLIS RS F:12" - R:14"	400	16	521378	
METROPOLIS RX-R ABS 13" - 14"	400	17 - 20	521377	521382
METROPOLIS SW ABS F:13" - R:14"	400	22	521377	521382
METROPOLIS ULTIMATE BUSINESS ABS 13" - 14"	400	19 - 20	521377	521382
METROPOLIS ULTIMATE SPORT ABS 13" - 14"	400	19 - 20	521377	521382
SATELIS - RS - 2 RS	400	07 - 17	483313	
GÉOPOLIS PREMIUM	500	07 - 12	483313	
SATELIS	500	06 - 13	483313	

MOTEUR

CYCLE

PNEUMATIQUE

ATELIER

ACCESSOIRES

ÉLECTRICITÉ

FILTRATION

FREINAGE

TRANSMISSION



Modèle	Cylindrée	Année	Avant	Arrière
SATELIS PREMIUM RS	500	06 - 12	483313	
SATELIS RS	500	07	483313	
SATELIS ABS	600	04	483313	
PGO				
BUBU	125	03 - 08	440745	
CHARGE A - B	125	01 - 02	440745	
LIGERO 2T	125	06 - 08	440745	
T-REX	125	99 - 16	440745	
TORNADO	125	97 - 02	320158	
PIAGGIO				
ZIP	E	02	320158	
BEVERLY - BEVERLY E3	125	01 - 08	483311	483311
BEVERLY E3 MIC	125	07	483311	483311
BEVERLY E3 SPORT	125	07 - 08	483311	483311
BEVERLY E3 SPORT	125	08 - 10	483311	483311
BEVERLY NEW I.E.	125	16	495192	
BEVERLY RST	125	04 - 07	483311	483311
BEVERLY RST 4T 4V I.E.	125	10 - 11	483311	483311
BEVERLY S	125	08 - 10	495192	495192
SKIPPER LX	125	98 - 02	518051	
SKR - STEALTH	125	96	518051	
SKR ST 4T	125	01 - 02	518051	
SUPER HEXAGON GTX	125	01 - 03	483310	483303
TYPHOON	125	95 - 09	465366	
TYPHOON 2T 12"	125	12 - 20	518051	
TYPHOON 4T 12"	125	12 - 17	518051	
TYPHOON X-R	125	00	277093	
X EVO	125	04 - 17	483311	483310
X EVO SPORT	125	15 - 17	483311	483310
X7 - X7 EVO I.E.	125	08 - 14	483311	483310
X8	125	04 - 16	483311	483310
X8 STREET	125	06	483311	
X9 - X9 EVOLUTION	125	00 - 07	495192	495192
SKR	150	01 - 02	518051	
STEAKTH	150	96	518051	
X8 STREET	150	06	483311	
SUPER HEXAGON GTX-11"	180	01 - 03	483310	483303
X9 AMALFI 4T	180	00 - 03	495192	495192
BEVERLY	200	02 - 06	483311	483311
CARNABY ES	200	07 - 09	483311	483311
X8	200	04 - 05	483311	483310
X9	200	02 - 03	495192	495192
X9 AMALFI	200	01 - 02	495192	495192
X9 EVOLUTION	200	03 - 04	495192	495192

MOTEUR
CYCLE
PNEUMATIQUE
ATELIER
ACCESSOIRES
ÉLECTRICITÉ
FILTRATION
FREINAGE
TRANSMISSION



Modèle	Cylindrée	Année	Avant	Arrière
BEVERLY	250	04 - 07	483311	483311
BEVERLY TOURER I.E.	250	07 - 08	483311	483311
CARNABY I.E.	250	08 - 09	483311	483311
X EVO SPORT	250	15 - 17	483311	483310
X-EVO I.E.	250	07 - 10	483311	483310
X7	250	08 - 09	483311	483310
X8 PREMIUM I.E.	250	06 - 09	483311	483310
X9 - X9 EVOLUTION	250	00 - 06	495192	495192
BEVERLY TOURER I.E.	300	09 - 10	483311	483311
CARNABY	300	13	483311	483311
X7 EVO I.E.	300	09 - 13	483311	483310
BEVERLY I.E.	400	06 - 08	483311	483310
TOURER I.E. - X8 I.E.	400	06 - 08	483311	483310
X-EVO I.E.	400	07 - 11	495192	495192
BEVERLY	500	02 - 06	483311	483310
BEVERLY CRISER I.E. VERSION JUSQU'À MARS 2007	500	07	483311	483310
X9 EVOLUTION - ABS	500	03 - 07	483311	483310
X9 EVOLUTION ABS	500	06 - 07	483311	483310
X9 SL 4T	500	00 - 02	483311	483310
RENAULT				
KOURANOS	250	03	319990	
RIEJU				
MARATHON	125	14	518199	
MARATHON	125	14	483293	
NKD	125	08 - 09	486943	486944
RS 2 - RS 2 PRO	125	05 - 09	486943	486944
RSZ	125	05	486943	
SACHS BIKE				
MADASS	125	07 - 09	498898	440735
SCARABEO				
I.E.	125	10 - 15	495192	
NET	125	10 - 11	495192	
I.E.	200	10 - 15	495192	
NET	200	10 - 11	495192	
SCORPA				
T-RIDE F	250	06	485542	
SHERCO				
CITYCORP ENDURO	125	07 - 08	485542	
SE	125	09 - 11	485542	
TECHNISCHE X-RIDE	290	12 - 13	485542	
SYM				
ALLO 4T	125	12 - 17	277093	
FIDDLE III 4T CBS 12"	125	14 - 17	277093	
FIDDLE III 4T CBS 12"	125	18	277093	



Modèle	Cylindrée	Année	Avant	Arrière
GTS - GTS EFI	125	06 - 07	483319	
GTS I EVO - E3	125	08 - 16	483319	
JOYMAX I - XI	125	12 - 14	483319	
JOYRIDE I S ABS F:13" - R:12"	125	20 - 22	483319	
X-PRO - X-PRO I CBS	125	12 - 17	440745	
FIDDLE II 151	150	12 - 13	440745	
FIDDLE III	200	14 - 15	440745	
FIDDLE III I ABS	200	16 - 19	440745	
GTS	200	07 - 08	483319	
GTS	200	12	483319	
JOYMAX - I E3	200	05 - 08	483319	
JOYMAX EVO	200	09	483319	
JOYMAX I - EVO	200	10 - 12	483319	
JOYRIDE I S ABS F:13" - R:12"	200	20 - 22	483319	
GTS	250	06 - 08	483319	
JOYMAX - JOYMAX I E3	250	05 - 08	483319	
JOYMAX I	250	03 - 09	483319	
JOYMAX XI	250	10 - 12	483319	
GTS EVO	300	09 - 10	483319	
GTS I	300	13	483319	
JOYMAX I - XI	300	12 - 13	483319	
JOYMAX I EVO	300	09 - 12	483319	
TGB				
202 T	125	99	440745	
303 R	125	99	440745	
303 REVOLUTION	125	02 - 03	440745	
309 RS	125	00	440745	
EXPRESS	125	17 - 18	440745	
F409 CRUISE	125	02 - 05	440745	
303 R - 309 RS	150	00	440745	
TOMOS				
SE 4T	125	05 - 06	450418	450419
SM 4T	125	05 - 06	485125	450419
UVM				
BINGO	125	99	320158	
VAN.EKO				
THE BE.E	E	17	277093	
VESPA				
GRANTURISMO L	125	01 - 03	518051	
YAMAHA				
CRYPTON X	125	05 - 08	450418	450419
CYGNUS X 12"	125	07	493619	
CYGNUS X NXC	125	07 - 10	493619	
CYGNUS XC	125	07	493619	



Modèle	Cylindrée	Année	Avant	Arrière
MAJESTY YP	125	98 - 09	477499	
MAJESTY YP DT	125	98 - 00	477499	
MAJESTY YP E - YP LTD	125	01 - 09	477499	483307
MT - MT ABS	125	14 - 19	521371	
MT ABS	125	20 - 23	521371	
R ABS	125	19	521371	
R ABS	125	20 - 21	521371	
R ABS	125	22	521371	
R MONSTER ENERGY MOTOGP	125	19 - 21	521371	
R WORLD GP 60TH ANNIVERSARY	125	22	521371	
SR	125	95 - 14	483308	
TEO'S	125	03	477499	
TEO'S	125	99 - 02	477499	
VITY - VITY R 4T 10"	125	08 - 11	320158	
XMAX - I - ABS	125	05 - 09	483305	
XMAX - I - ABS	125	05 - 09	486941	483306
XMAX - I - ABS	125	05 - 09	521369	
XMAX ABS	125	18 - 20	521381	521376
XMAX ABS	125	21 - 23	521383	521376
XMAX IRON MAX YP R ABS	125	16 - 17	521375	521376
XMAX IRON MAX YP R ABS	125	18 - 20	521381	521376
XMAX TECH MAX ABS	125	18 - 20	521381	521376
XMAX TECH MAX ABS	125	21 - 23	521383	521376
XMAX YP R - ABS	125	10 - 13	483305	
XMAX YP R - ABS	125	10 - 13	486941	
XMAX YP R - ABS	125	10 - 13	521369	
XMAX YP R - ABS	125	14 - 17	521375	521376
XT R	125	05 - 12	465373	
XT R	125	05 - 12	450418	450419
XT X	125	05	369567	
YZF R ABS	125	14 - 18	521371	
MAJESTY YP - YP E	150	01 - 06	477499	483307
MAJESTY YP - YP TEO'S	150	98 - 00	477499	
TEO'S	150	01	477499	
MAJESTY YP - LTD - E	180	01 - 06	477499	483307
SR	200	97	483308	
IRON MAX	250	16	483305	
IRON MAX	250	16	486941	
IRON MAX	250	16	521369	
X-MAX YP R	250	05 - 09	483305	
X-MAX YP R	250	05 - 09	486941	483306
X-MAX YP R	250	05 - 09	521369	
X-MAX YP R - ABS - IRON MAX	250	14 - 16	483305	
X-MAX YP R - ABS - IRON MAX	250	14 - 16	486941	

MOTEUR

CYCLE

PNEUMATIQUE

ATELIER

ACCESSOIRES

ÉLECTRICITÉ

FILTRATION

FREINAGE

TRANSMISSION



Modèle	Cylindrée	Année	Avant	Arrière
X-MAX YP R - ABS - IRON MAX	250	14 - 16	521369	
X-MAX YP R - ABS- IRON MAX - ABS	250	16 - 17	521375	
X-MAX YP R SPORT	250	10 - 13	483305	
X-MAX YP R SPORT	250	10 - 13	486941	
X-MAX YP R SPORT	250	10 - 13	521369	
GRAND MAJESTY (JAPAN)	250	04 - 05	483305	
GRAND MAJESTY (JAPAN)	250	04 - 05	486941	
GRAND MAJESTY (JAPAN)	250	04 - 05	521369	
XMAX ABS	300	17 - 21	521381	521376
XMAX ABS	300	22 - 23	521383	521376
XMAX IRON MAX ABS	300	17 - 20	521381	521376
XMAX TECH MAX ABS	300	20 - 21	521381	521376
XMAX TECH MAX ABS	300	22 - 23	521383	521376
RD F - N - R	350	85 - 93	483308	
RD YPVS	350	83 - 84	483308	
FZ N	400	85	483308	
MAJESTY YP - ABS	400	04 - 13	483305	
MAJESTY YP - ABS	400	04 - 13	486941	
MAJESTY YP - ABS	400	04 - 13	521369	
XMAX ABS	400	13 - 14	486941	
XMAX ABS	400	13 - 14	521369	
XMAX ABS	400	15 - 21	486941	
XMAX ABS	400	15 - 21	521369	
XMAX IRON MAX ABS	400	16	486941	
XMAX IRON MAX ABS	400	16	521369	
XMAX IRON MAX ABS	400	17 - 20	486941	
XMAX IRON MAX ABS	400	17 - 20	521369	
XMAX SPORT - ABS	400	17 - 18	486941	
XMAX TECH MAX ABS	400	20 - 21	486941	
XMAX TECH MAX ABS	400	20 - 21	521369	
XMAX X-MAX SPORT - ABS	400	17 - 18	521369	
XS	400	82	483308	
GRAN MAJESTY SP (JAPAN)	400	05	483305	
GRAN MAJESTY SP (JAPAN)	400	05	486941	
GRAN MAJESTY SP (JAPAN)	400	05	521369	
RD L.C.	500	84 - 88	483308	
XP T-MAX	500	08 - 11	483308	
XP T-MAX	500	08 - 11	521369	
XP T-MAX - BLACK MAX	500	04 - 07	483305	483309
XP T-MAX - BLACK MAX	500	04 - 07	486941	
XP T-MAX - BLACK MAX	500	04 - 07	521369	
XT	500	86	483308	
TMAX - ABS	530	17 - 19	486941	486942
TMAX - ABS	530	17 - 19	521369	

				
Modèle	Cylindrée	Année	Avant	Arrière
TMAX - TMAX ABS	530	12 - 14	486941	486942
TMAX - TMAX ABS	530	12 - 14	521369	
TMAX - TMAX ABS	530	15 - 16	486941	486942
TMAX - TMAX ABS	530	15 - 16	521369	
TMAX DX 2019 ABS	530	17 - 21	486941	486942
TMAX DX 2019 ABS	530	17 - 21	521369	
TMAX IRON MAX - ABS	530	15 - 16	486941	486942
TMAX IRON MAX - ABS	530	15 - 16	521369	
TMAX LUX MAX - ABS	530	15 - 16	486941	486942
TMAX LUX MAX - ABS	530	15 - 16	521369	
TMAX SX ABS	530	17 - 19	486941	486942
TMAX SX ABS	530	17 - 19	521369	
TMAX SX SPORT EDITION ABS	530	17 - 19	486941	486942
TMAX SX SPORT EDITION ABS	530	17 - 19	521369	
XZ	550	82 - 84	483308	
TMAX - TMAX TECH MAX ABS	562	20 - 22	486941	486942
TMAX - TMAX TECH MAX ABS	562	20 - 22	521369	
FZ	600	86 - 88	483308	
SRX	600	85 - 87	483308	
XT K	600	92	483308	
YX RADIANT	600	86 - 90	483308	
XJ SEKA - XJ TURBO	650	82 - 83	483308	
FZX	700	86 - 87	483308	
FZ GENESIS	750	87 - 88	483308	
FZX FAZER	750	86 - 90	483308	
XV VIRAGO	750	87 - 93	483308	
XJ	900	83 - 84	483308	
XJ	900	87 - 94	483308	
XJ F	900	83 - 94	483308	
MT-10 TOURER EDITION ABS	1000	86	483308	
XV VIRAGO	1100	86 - 93	483308	



GALFER
MOTO

/ CARACTÉRISTIQUES :

- Frein puissant, progressif et modulaire
- Faible taux d'usure et bruit minimum
- Résistance maximale à l'effet de décoloration
- Efficacité en conditions humides
- Aucune usure du disque de frein



Approuvé
ECE R90
pour tous
les composés

LES PLAQUETTES DE FREIN /

Les plaquettes de frein sont des éléments fondamentaux de tout système de freinage car elles sont directement responsables de la transmission de la puissance de l'étrier au disque de frein. **Galfer** a développé des composés spécifiques pour chaque utilisation et modèle de moto, cherchant à offrir les meilleures performances dans tout type de conduite et pour tous les profils et besoins des utilisateurs.

/ G1050



/ PLAQUETTE DE FREIN SEMI-MÉTALLIQUE SPÉCIFIQUE POUR SCOOTER

- Excellent rapport qualité/prix.
- Performances optimales dans toutes les conditions.

APPLICATION : Urbain
COMPOSÉ : Semi-Métallique

Matériel de friction semi-métallique, conçu pour avoir d'excellentes performances et une sécurité maximale même avec des motos de petites et moyennes cylindrées. Il maintient ses qualités dans toutes les conditions météorologiques.

Km	■	■	■	■	■
+C°	■	■	■	■	■
-C°	■	■	■	■	■
☀	■	■	■	■	■
☂	■	■	■	■	■
FADING	■	■	■	■	■
FEEL	■	■	■	■	■

/ G1054



/ COMPOSÉ SEMI-MÉTALLIQUE

- Composé multifonctionnel sans effet FADE.
- Temps de rodage court.

APPLICATION : Urbain, tout terrain, Custom
COMPOSÉ : Semi-Métallique

Ce matériel de friction représente le passé, le présent et le futur de la production semi-métallique chez **GALFER**. Ce matériel de friction est produit depuis des années avec des améliorations techniques régulières, il est toujours apprécié et utilisé par les usines en première monte d'origine. Il présente un excellent coefficient de friction, une faible usure, un freinage progressif et efficace. La plaquette G1054 est un produit qui convient à tous types de 2 roues.

Km	■	■	■	■	■
+C°	■	■	■	■	■
-C°	■	■	■	■	■
☀	■	■	■	■	■
☂	■	■	■	■	■
FADING	■	■	■	■	■
FEEL	■	■	■	■	■

/ G1380



/ PLAQUETTE DE FREIN SINTERED SPÉCIFIQUE POUR SCOOTER

- Très faible bruit.
- Longue durée de vie.

APPLICATION : Urbain, Custom
COMPOSÉ : Métal Sintered

G1380 est une plaquette sintered présentant des caractéristiques spécifiques pour les maxi-scooters associant un freinage sûr et progressif à un prix compétitif. Elle garantit un freinage puissant sans aucun effet « fading » et constant dans toutes les conditions climatiques.

Km	■	■	■	■	■
+C°	■	■	■	■	■
-C°	■	■	■	■	■
☀	■	■	■	■	■
☂	■	■	■	■	■
FADING	■	■	■	■	■
FEEL	■	■	■	■	■

Km Durabilité +C° : Performances à haute température -C° : Performances à basse température ☀ : Performances sèches ☂ : Performances sur sol mouillé FADING : Résistance à l'effet de Fade FEEL : Ressenti

PLAQUETTES DE FREIN - MÂCHOIRES DE FREIN / BRAKE PADS - BRAKE SHOE

CGN
LE SENS DU DÉTAIL

MOTEUR

CYCLE

PNEUMATIQUE

ATELIER

ACCESSOIRES



ÉLECTRICITÉ

FILTRATION

FREINAGE

TRANSMISSION

Modèle	Cylindre	Depuis	Jusqu'à	GALFER MOTO Plaquettes avant			N° Schéma	Mâchoires avant G2165
				SEMI MÉTALLIQUES G1050	SEMI MÉTALLIQUES G1054	SINTERED G1380		
ADIVA								
AD 125	125	9		507116	507252	507164	14	
AD 250	250	9		507116	507252	507164	14	
AD 400	400	9		507116	507252	507164	14	
ADLY								
SUPER SONIC 125 B	125	3		507085	507222	507152	25	
THUNDER BIKE 125	125	6		507085	507222	507152	25	
CAT 125	125	6					12	507383
NOBLE 125	125	5					12	507383
ADLY 4 WHEELS								
320 4 VALVE 4X4	320	8						
ATV 280 S	280	8						
ATV 280 U	280	8						
ATV 320 S	320	8						
ATV 320 U	320	8						
ATV 500 S	500	8						
CRUSADER QUAD 150	150	6		507085	507222	507152	25	
CRUSADER QUAD 300	300	6		507085	507222	507152	25	
INTERCEPTOR 150	150	6		507085	507222	507152	25	
INTERCEPTOR 300	300	6		507085	507222	507152	25	
AEON								
ELITE 200i	200	11		507085	507222	507152	25	
URBAN 125	125	11		507085	507222	507152	25	
URBAN 350i	350	11		507085	507222	507152	25	
NOX 125	125	6						
NOX 150	150	6						
PULSAR 125	125	6						
PULSAR 150	150	6						
AEON 4 WHEELS								
COBRA 220	220	6		507085	507222	507152	25	
OVERLAND 3.0	300	6		507085	507222	507152	25	
COBRA RS 125	125	3		507088	507225		31	
COBRA RS 180	180	3		507088	507225		31	
OVERLAND 125	125	3		507088	507225		31	
OVERLAND 180	180	3		507088	507225		31	
ROADSTER 180	180	3		507088	507225		31	
CROSSLAND RX 350	350	11		507088	507225		31	
AJP								
MX 200	200	9		507077	507212	507151	6	
PR 5 ENDURO 250	250	9	10		507300		125	
PR 5 SUPERMOTO 250	250	9	10		507300		125	
PR 5 ENDURO 250	250	11			507300		125	

 Plaquettes arrière			 Mâchoires arrière	
SEMI MÉTALLIQUES G1050	SEMI MÉTALLIQUES G1054	SINTERED G1380	N° Schéma	G2165
507108	507247	507159	34	
507116	507252	507164	14	
507116	507252	507164	14	
507085	507222	507152	25	
507085	507222	507152	25	
507092	507229		69	
507085	507222	507152	25	
	507363		179	
	507363		179	
	507363		179	
	507363		179	
	507363		179	
	507363		179	
507085	507222	507152	25	
507085	507222	507152	25	
507085	507222	507152	25	
	507363		179	
507107	507246	507158	102	
507107	507246	507158	102	
507107	507246	507158	102	
507085	507222	507152	25	
507085	507222	507152	25	
507085	507222	507152	25	
507085	507222	507152	25	
507085	507222	507152	25	
507085	507222	507152	25	
507085	507222	507152	25	
		507181	37	
	507319		144	
	507319		144	
	507369		185	

PLAQUETTES DE FREIN - MÂCHOIRES DE FREIN / BRAKE PADS - BRAKE SHOE

MOTEUR

CYCLE

PNEUMATIQUE

ATELIER

ACCESSOIRES



ÉLECTRICITÉ

FILTRATION

FREINAGE

TRANSMISSION

Modèle	Cylindre	Depuis	Jusqu'à	GALFER MOTO			N° Schéma	Mâchoires avant G2165
				Plaquettes avant				
				SEMI MÉTALLIQUES G1050	SEMI MÉTALLIQUES G1054	SINTERED G1380		
PR 5 SUPERMOTO 250	250	11			507300		125	
ENDURO 250	250	5			507343		157	
PR 4 125 ENDURO	125	5	9		507343		157	
PR 4 125 SM	125	5	9		507343		157	
PR 4 125 ENDURO / PRO	125	10		507124	507260		24	
PR 4 125 SM / PRO	125	10		507124	507260		24	
PR 4 200 ENDURO / PRO	200	10		507124	507260		24	
PR 4 200 SM / PRO	200	10		507124	507260		24	
PR 7 ADVENTURE 650	650	20			507358		170	
AKT								
NKD 125	125	11		507086	507223		9	
RTX UNISHOCK 150	150	15		507086	507223		9	
AK 200 XM	200			507086	507223		9	
AK 235 R	235			507086	507223		9	
XM 180	180	11		507086	507223		9	
AK 180 XM XTREME MOTARD	180			507107	507246	507158	102	
TT 250 ADVENTOUR	250	16			507371		187	
AK 125 DYNAMIC	125							
AK 125 EVO	125							
AK 125 FLEX	125							
AK 125 JET 4	125							
AK 125 NKD	125							
AK 125 SL	125							
AK 125 SPORT	125							
AK 125 TT	125							
AK 150	150							
AK 150 EVO	150							
AK 150 TT	150							
AK 250 F RANCHERO	250							
CR5 180	180	15						
EVO R3 125	125	15						
EVO R3 150	150	15						
FLEX 125	125	13						
JET 4 R	125							
RTX 150	150							
TTR 125	125	13						
TTR 150	150	13						
TTR 180	180	15						
TTX 180	180	15						
ALFER								
300 TX	300	90		507074	507202		2	
125 MC	125	88		507074	507202		2	

 Plaquettes arrière			 Mâchoires arrière	
SEMI MÉTALLIQUES G1050	SEMI MÉTALLIQUES G1054	SINTERED G1380	N° Schéma	G2165
	507369		185	
	507227	507153	39	
	507227	507153	39	
	507227	507153	39	
		507181	37	
		507181	37	
		507181	37	
		507181	37	
507143	507230	507154	48	
507079	507214		38	
507079	507214		38	
	507221		33	
	507221		33	
	507221		33	
507086	507223		9	
507108	507247	507159	34	
	507221		33	
507134	507271		79	
507108	507247	507159	34	
	507221		33	
507079	507214		38	
507079	507214		38	
507088	507225		31	
	507221		33	
	507221		33	
507088	507225		31	
507079	507214		38	
507104	507242	507157	63	
507079	507214		38	
507079	507214		38	
507086	507223		9	
507108	507247	507159	34	
507108	507247	507159	34	
	507221		33	
	507221		33	
	507221		33	
	507221		33	
507077	507212	507151	6	
507084	507220		91	

PLAQUETTES DE FREIN - MÂCHOIRES DE FREIN / BRAKE PADS - BRAKE SHOE

MOTEUR

CYCLE

PNEUMATIQUE

ATELIER

ACCESSOIRES



ÉLECTRICITÉ

FILTRATION

FREINAGE

TRANSMISSION

Modèle	Cylindre	Depuis	Jusqu'à	GALFER MOTO Plaquettes avant			N° Schéma	Mâchoires avant G2165
				SEMI MÉTALLIQUES G1050	SEMI MÉTALLIQUES G1054	SINTERED G1380		
250 AR	250	92	92	507081	507216		23	
250 AR	250	93		507081	507216		23	
250 VR	250	94	94	507081	507216		23	
300 GR ENDURO	300	89		507084	507220		91	
125 VR 4T	125	3			507320		145	
125 VR 4T NO LIMITS	125	3			507320		145	
250 VR ENDURO	250	95			507320		145	
250 VR MOTOCROSS	250	95			507320		145	
NO LIMITS	250	95			507320		145	
250 GR ENDURO	250	85						
250 MC	250	85						
300 GR ENDURO	300	85	88					
ALPINA								
RENANIA VERONA 125	125	6		507115	507251	507163	66	
APRILIA								
ASR 125	125	86		507074	507202		2	
TUAREG WIND 125	125	89		507074	507202		2	
ETX 350	350	85	86	507074	507202		2	
ETX 350 AE	350	87		507074	507202		2	
ETX 600 A, E	600	85		507074	507202		2	
TUAREG 350	350	85	86	507074	507202		2	
TUAREG 350 WIND	350	87	88	507074	507202		2	
TUAREG RALLY 250	250	85		507074	507202		2	
AF 1125 REPLICA	125	89	89	507074	507202		2	
AF1 125	125	87	88	507074	507202		2	
AF 1125 FUTURA	125	90		507074	507202		2	
AF 1125 SINTESI	125	89	89	507074	507202		2	
EUROPA 125	125	91		507074	507202		2	
RED ROSE 125 AE	125	91		507074	507202		2	
AF1 125	125	85	86	507075	507210		4	
CLIMBER 250	250	90	91	507075	507210		4	
CLIMBER 250 R	250	92		507075	507210		4	
CLIMBER 280 R	280	93		507075	507210		4	
CLIMBER 250	250	89	89	507077	507212	507151	6	
TXR 312 M	312	88		507077	507212	507151	6	
REPLICA 250	250	92		507077	507212	507151	6	
PEGASO 125	125	89	90	507081	507216		23	
PEGASO 600 4 VALVOLE	600	91		507081	507216		23	
RX 125	125	90	90	507081	507216		23	
TUAREG 350 WIND	350	89		507081	507216		23	
TUAREG 600 WIND(PARIS DAKAR)	600	89	90	507081	507216		23	
TUAREG 600 WIND	600	89	90	507081	507216		23	

				
Plaquettes arrière			Mâchoires arrière	
SEMI MÉTALLIQUES G1050	SEMI MÉTALLIQUES G1054	SINTERED G1380	N° Schéma	G2165
	507298		123	
507143	507230	507154	48	
507143	507230	507154	48	
	507298		123	
507143	507230	507154	48	
507143	507230	507154	48	
507143	507230	507154	48	
507143	507230	507154	48	
507143	507230	507154	48	
507074	507202		2	
507074	507202		2	
507074	507202		2	
507104	507242	507157	63	
507080	507215		88	
507080	507215		88	
507080	507215		88	
507080	507215		88	
507080	507215		88	
507080	507215		88	
	507298		123	
	507298		123	
507089	507226		93	
507089	507226		93	
507089	507226		93	
	507227	507153	39	
507075	507210		4	
507077	507212	507151	6	
507077	507212	507151	6	
507077	507212	507151	6	
507077	507212	507151	6	
507077	507212	507151	6	
507078	507213		87	
	507298		123	
	507298		123	
	507298		123	
	507311		136	

PLAQUETTES DE FREIN - MÂCHOIRES DE FREIN / BRAKE PADS - BRAKE SHOE

CGN
LE SENS DU DÉTAIL

MOTEUR

CYCLE

PNEUMATIQUE

ATELIER

ACCESSOIRES



ÉLECTRICITÉ

FILTRATION

FREINAGE

TRANSMISSION

Modèle	Cylindre	Depuis	Jusqu'à	GALFER MOTO			N° Schéma	Mâchoires avant G2165
				Plaquettes avant				
				SEMI MÉTALLIQUES G1050	SEMI MÉTALLIQUES G1054	SINTERED G1380		
TUAREG RALLY 125	125	89	90	507081	507216		23	
RX 125	125	92	92	507081	507216		23	
PEGASO 650	650	98	0	507081	507216		23	
RC 125	125	89		507082	507218		70	
TUONO 125	125	16		507085	507222	507152	25	
PEGASO 650	650	91	93	507091	507228		22	
RX 125	125	91	91	507091	507228		22	
TUAREG 600 WIND AE	600	91		507091	507228		22	
PEGASO 125	125	91	92	507091	507228		22	
PEGASO 600 AE	600	91		507091	507228		22	
TUAREG RALLY 125	125	91		507091	507228		22	
MX 125	125	4		507091	507228		22	
RX 125	125	8		507091	507228		22	
SX 125	125	8		507091	507228		22	
RX 125	125	95		507091	507228		22	
MOTO 6.5	650	95		507091	507228		22	
CAPONORD RAID	1000	3		507143	507230	507154	48	
RST FUTURA	1000	1		507143	507230	507154	48	
RS 250	250	95	97	507102	507239	507156	3	
TUONO 125	125	3	15	507102	507239	507156	3	
LEONARDO 125 4T	125	96	98	507102	507239	507156	3	
LEONARDO 150 4T	150	98	98	507102	507239	507156	3	
RS 250	250	98		507102	507239	507156	3	
PEGASO 650 ie FACTORY	650	6	8		507320		145	
PEGASO 1000	1000	1			507320		145	
PEGASO 650 ie	650	1	6		507320		145	
TUAREG 660	660	22			507320		145	
DORSODURO 1200	1200	11			507320		145	
PEGASO 650 ie	650	7			507320		145	
PEGASO 650 STRADA	650	5			507320		145	
DORSODURO	750	8			507320		145	
DORSODURO 900	896	17			507320		145	
DORSODURO FACTORY	750	10			507320		145	
MANA	850	7			507320		145	
MANA GT / ABS	850	9			507320		145	
MANA X / ABS	850	10			507320		145	
SHIVER	750	7			507320		145	
SHIVER 900	896	17			507320		145	
SHIVER SL GT / ABS	750	9			507320		145	
CAPONORD 1200	1200	13			507320		145	
PEGASO 125 KAT	125	93						
RS 125 EXTREMA, REPLICIA	125	92	5					

 Plaquettes arrière			 Mâchoires arrière	
SEMI MÉTALLIQUES G1050	SEMI MÉTALLIQUES G1054	SINTERED G1380	N° Schéma	G2165
	507311		136	
	507227	507153	39	
	507322		147	
	507298		123	
507137	507274		21	
	507298		123	
	507298		123	
	507227	507153	39	
	507227	507153	39	
	507227	507153	39	
507143	507230	507154	48	
507143	507230	507154	48	
507143	507230	507154	48	
		507181	37	
	507322		147	
	507322		147	
	507324		149	
507078	507213		87	
507089	507226		93	
507102	507239	507156	3	
507102	507239	507156	3	
	507324		149	
	507322		147	
	507322		147	
	507322		147	
	507324		149	
	507324		149	
	507324		149	
	507324		149	
	507368		184	
	507368		184	
	507368		184	
	507368		184	
	507368		184	
	507368		184	
	507368		184	
	507368		184	
	507368		184	
	507199		83	
507089	507226		93	
507089	507226		93	

PLAQUETTES DE FREIN - MÂCHOIRES DE FREIN / BRAKE PADS - BRAKE SHOE

CGN
LE SENS DU DÉTAIL

MOTEUR

CYCLE

PNEUMATIQUE

ATELIER

ACCESSOIRES

ÉLECTRICITÉ

FILTRATION

FREINAGE

TRANSMISSION

Modèle	Cylindre	Depuis	Jusqu'à	GALFER MOTO			Plaquettes avant		GALFER MOTO	
				SEMI MÉTALLIQUES G1050	SEMI MÉTALLIQUES G1054	SINTERED G1380	N° Schéma	Mâchoires avant G2165		
SPORT PROT 125	125	92	94							
RX 125 C, CD	125	93	94							
PEGASO 650	650	94	97	507105	507243		1			
SR GT 125	125	22		507108	507247	507159	34			
SR GT 125 SPORT	125	22		507108	507247	507159	34			
SR GT 200	200	22		507108	507247	507159	34			
SR GT 200 SPORT	200	22		507108	507247	507159	34			
RSV TUONO V4 FACTORY	1100	17		507116	507252	507164	14			
RSV TUONO V4 RR	1100	17		507116	507252	507164	14			
RSV4 FACTORY	1000	9		507116	507252	507164	14			
RSV4 R	1000	9	14	507116	507252	507164	14			
RSV4 RR	1000	15	16	507116	507252	507164	14			
RSV4 RR	1000	17		507116	507252	507164	14			
RSV4 RR FW	1000	18	19	507116	507252	507164	14			
RSV4 RR FW	1000	20		507116	507252	507164	14			
RSV4 XTRENTA	1000	23		507116	507252	507164	14			
ETV CAPONORD	1000	1		507116	507252	507164	14			
BLUE MARLIN	1000	2		507116	507252	507164	14			
RSV MILLE	1000	98	0	507116	507252	507164	14			
RSV MILLE R	1000	0	0	507116	507252	507164	14			
RSV MILLE SP	1000	0		507116	507252	507164	14			
RSV TUONO	1000	2	5	507116	507252	507164	14			
RSV TUONO V4 R	1000	11		507116	507252	507164	14			
SL 1000 FALCO	1000	0		507116	507252	507164	14			
RSV MILLE	1000	1		507116	507252	507164	14			
RSV MILLE R	1000	1		507116	507252	507164	14			
RSV R FACTORY	1000	4		507116	507252	507164	14			
RSV TUONO R	1000	2		507116	507252	507164	14			
RS 660	660	21		507116	507252	507164	14			
RS 660 EXTREMA	660	23		507116	507252	507164	14			
RSV TUONO V4 R	1100	15		507116	507252	507164	14			
TUONO 660	660	21		507116	507252	507164	14			
TUONO 660 FACTORY	660	22		507116	507252	507164	14			
ARRECIFE 500	500	2		507120	507256	507166	7			
ATLANTIC 500	500	2		507120	507256	507166	7			
LEONARDO 250 4T	250	99		507120	507256	507166	7			
LEONARDO 300	300	4		507120	507256	507166	7			
SCARABEO 125 4T	125	98	4	507120	507256	507166	7			
SCARABEO 150 4T	150	98		507120	507256	507166	7			
SCARABEO 200 / GT	200	2	6	507120	507256	507166	7			
SCARABEO 250	250	4	4	507120	507256	507166	7			
SCARABEO 400 ie	400	7		507120	507256	507166	7			

GALFER MOTO			GALFER MOTO	
Plaquettes arrière			Mâchoires arrière	
SEMI MÉTALLIQUES G1050	SEMI MÉTALLIQUES G1054	SINTERED G1380	N° Schéma	G2165
507089	507226		93	
		507181	37	
		507181	37	
	507369		185	
	507369		185	
	507369		185	
	507369		185	
	507322		147	
	507324		149	
	507324		149	
	507324		149	
	507324		149	
	507324		149	
	507324		149	
	507324		149	
	507347		161	
	507347		161	
	507347		161	
	507347		161	
	507199		83	
	507199		83	
	507199		83	
	507199		83	
	507199		83	
507080	507215		88	
507080	507215		88	
507080	507215		88	
507080	507215		88	
507080	507215		88	
507080	507215		88	
507080	507215		88	
507080	507215		88	
507080	507215		88	
507080	507215		88	
507080	507215		88	
507080	507215		88	

PLAQUETTES DE FREIN - MÂCHOIRES DE FREIN / BRAKE PADS - BRAKE SHOE

MOTEUR

CYCLE

PNEUMATIQUE

ATELIER

ACCESSOIRES

ÉLECTRICITÉ

FILTRATION

FREINAGE

TRANSMISSION

Modèle	Cylindre	Depuis	Jusqu'à	GALFER MOTO			GALFER MOTO	
				Plaquettes avant			Mâchoires avant	
				SEMI MÉTALLIQUES G1050	SEMI MÉTALLIQUES G1054	SINTERED G1380	N° Schéma	G2165
SCARABEO 500	500	3		507120	507256	507166	7	
SCARABEO 500 ABS++	500	3		507120	507256	507166	7	
SPORT CITY 125	125	4		507120	507256	507166	7	
SPORT CITY 200	200	4		507120	507256	507166	7	
SPORT CITY 250	250	6		507120	507256	507166	7	
SPORT CITY CUBE 300	300	8		507120	507256	507166	7	
ARRECIFE 125	125	3	5	507120	507256	507166	7	
ARRECIFE 125 SPRINT	125	6		507120	507256	507166	7	
ARRECIFE 200	200	3		507120	507256	507166	7	
ARRECIFE 250 SPRINT	250	6		507120	507256	507166	7	
ARRECIFE 300	300	10		507120	507256	507166	7	
ARRECIFE 400 SPRINT	400	7		507120	507256	507166	7	
ARRECIFE 500 SPRINT	500	5		507120	507256	507166	7	
ATLANTIC 125	125	3	5	507120	507256	507166	7	
ATLANTIC 125 SPRINT	125	6		507120	507256	507166	7	
ATLANTIC 200	200	3		507120	507256	507166	7	
ATLANTIC 250 SPRINT	250	6		507120	507256	507166	7	
ATLANTIC 300	300	10		507120	507256	507166	7	
ATLANTIC 400 SPRINT	400	7		507120	507256	507166	7	
ATLANTIC 500 SPRINT	500	5		507120	507256	507166	7	
SCARABEO 125 4T	125	5		507120	507256	507166	7	
SCARABEO 200	200	7		507120	507256	507166	7	
SCARABEO 250 ie	250	5		507120	507256	507166	7	
SCARABEO 300 S	300	9		507120	507256	507166	7	
RS 125	125	6	10	507120	507256	507166	7	
LEONARDO 125 4T	125	99		507122	507258		16	
LEONARDO 150 4T	150	99		507122	507258		16	
RX 125 (AJP)	125	8		507124	507260		24	
RS 4 125	125	11		507124	507260		24	
SRV 850	850	12		507131	507268	507170	35	
SR MAX 300	300	12		507131	507268	507170	35	
SXV 450	450	6			507356		168	
SXV 550	550	6			507356		168	
MXV 450	450	7			507356		168	
RXV 450	450	6			507356		168	
RXV 550	550	7			507356		168	
COMPAY	125	3						
ETX 125	125	85	85					
ETX 125	125	86						
ETX 125 PV	125	85	85					
HABANA	125	0	2					
HABANA CUSTOM	125	0	2					

PLAQUETTES DE FREIN - MÂCHOIRES DE FREIN / BRAKE PADS - BRAKE SHOE

MOTEUR

CYCLE

PNEUMATIQUE

ATELIER

ACCESSOIRES



ÉLECTRICITÉ

FILTRATION

FREINAGE

TRANSMISSION

Modèle	Cylindre	Depuis	Jusqu'à	GALFER MOTO			GALFER MOTO	
				Plaquettes avant			Mâchoires avant	
				SEMI MÉTALLIQUES G1050	SEMI MÉTALLIQUES G1054	SINTERED G1380	N° Schéma	G2165
MOJITO 125	125	5						
MX 250	250	83						
RED ROSE 125	125	89	90					
RX 125	125	85	85					
RX 125	125	86	89					
RX 250	250	83						
SPORT CITY ONE 125	125	8						
SR 125	125	98						
SR 150	150	0						
ST 125	125	87						
STX 125	125	84	85					
STX 125	125	86	86					
TREND GO WEST 125	125	87						
TUAREG RALLY 125	125	85	88					
TX 125 M	125	85						
TX 240	240	86						
TX 300 M	300	86						
TX 311 M	311	85						
ARCTIC CAT 4 WHEELS								
454 2X4/4X4 TODOS	454	98	4		507364		180	
1000 H2 TRV	1000	9			507364		180	
1000 THUNDERCAT	1000	8			507364		180	
1000 WILDCAT 1000i H.D.	1000	12			507364		180	
250 2X4/4X4 TODOS	250	5			507364		180	
300 2X4	300	10			507364		180	
300 4X4	300	5			507364		180	
400 FI 5 4X4	400	5			507364		180	
450 Hi	450	10			507364		180	
500 FI 5	500	5			507364		180	
500 TRV	500	5			507364		180	
650 4X4	650	5			507364		180	
650 HI 4X4	650	5			507364		180	
650 PROWLER XT	650	5			507364		180	
650 TRV	650	9			507364		180	
700 DIESEL TRV	700	6			507364		180	
700 HI TRV	700	9			507364		180	
700 SUPER DUTY DIESEL	700	10			507364		180	
ARMSTRONG								
500 MX	500	86						
600 MX	600	86						
ATK								
TODOS MODELOS		92	93	507074	507202		2	

 Plaquettes arrière			 Mâchoires arrière	
SEMI MÉTALLIQUES G1050	SEMI MÉTALLIQUES G1054	SINTERED G1380	N° Schéma	G2165
507102	507239	507156	3	
507074	507202		2	
507080	507215		88	
507074	507202		2	
507080	507215		88	
507074	507202		2	
507080	507215		88	
507122	507258		16	
507122	507258		16	
	507209		188	
	507209		188	
507080	507215		88	
507080	507215		88	
507077	507212	507151	6	
507077	507212	507151	6	
507077	507212	507151	6	
507077	507212	507151	6	
	507364		180	
	507364		180	
	507364		180	
	507364		180	
	507364		180	
	507364		180	
	507364		180	
	507364		180	
	507364		180	
	507364		180	
	507364		180	
	507364		180	
	507364		180	
	507364		180	
	507364		180	
	507364		180	
	507364		180	
	507364		180	
	507364		180	
	507364		180	
	507364		180	
	507364		180	
	507364		180	
	507364		180	
507074	507202		2	
507074	507202		2	
507084	507220		91	

PLAQUETTES DE FREIN - MÂCHOIRES DE FREIN / BRAKE PADS - BRAKE SHOE

MOTEUR

CYCLE

PNEUMATIQUE

ATELIER

ACCESSOIRES

ÉLECTRICITÉ

FILTRATION

FREINAGE

TRANSMISSION

Modèle	Cylindre	Depuis	Jusqu'à	GALFER MOTO			N° Schéma	Mâchoires avant G2165
				Plaquettes avant				
				SEMI MÉTALLIQUES G1050	SEMI MÉTALLIQUES G1054	SINTERED G1380		
560	560	87	88	507077	507212	507151	6	
560	560	89	91	507150	507219		12	
TODOS MODELOS		93	96		507221		33	
TODOS MODELOS		97			507320		145	
560	560	84	86					
BAJAJ								
DOMINAR 400	400	17			507320		145	
PULSAR 150 R	150	19			507320		145	
PULSAR 160 NS TD	160	19			507320		145	
PULSAR 200 ADVENTURE	200	15			507320		145	
PULSAR 200 NS	200	17			507320		145	
PULSAR 200 RS	200	17			507320		145	
PULSAR 220 F	220				507320		145	
PULSAR 220 S	220				507320		145	
AVENGER CRUISE DTS	220	15						
AVENGER STREET	150	15						
AVENGER STREET	220	15						
DISCOVER 125	125	14						
DISCOVER 135	135							
DISCOVER 150 F	150	17						
DISCOVER 150 M	150	14						
DISCOVER 150 S	150	17						
DISCOVER S 125	125	14						
DISCOVER ST	125	13						
PULSAR 135 LS	135	12						
PULSAR 150	150	17						
PULSAR 160 NS F	160	19						
PULSAR 180	180							
PULSAR 180 BLACKTEC	180							
PULSAR 180 UG	180							
PULSAR 200	200	15						
V 150	150	16						
XDC 125	125	14						
BAROSSA 4 WHEELS								
150 CHEETAH	150	3		507107	507246	507158	102	
150 MAGNA	150	3		507107	507246	507158	102	
170 CHEETAH	170	3		507107	507246	507158	102	
170 MAGNA	170	3		507107	507246	507158	102	
BENELLI								
350 RS	350	82		507074	507202		2	
354 SPORT T	354	78		507074	507202		2	
504	504	76		507074	507202		2	

PLAQUETTES DE FREIN - MÂCHOIRES DE FREIN / BRAKE PADS - BRAKE SHOE

CGN
LE SENS DU DÉTAIL

MOTEUR

CYCLE

PNEUMATIQUE

ATELIER

ACCESSOIRES



ÉLECTRICITÉ

FILTRATION

FREINAGE

TRANSMISSION

Modèle	Cylindre	Depuis	Jusqu'à	Plaquettes avant			N° Schéma	Mâchoires avant G2165
				SEMI MÉTALLIQUES G1050	SEMI MÉTALLIQUES G1054	SINTERED G1380		
125 BX	125	88	88	507074	507202		2	
125 BX	125	89		507074	507202		2	
125 JARNO	125	88	88	507074	507202		2	
125 JARNO	125	89		507074	507202		2	
UNO C 150	150	13		507074	507202		2	
UNO C 250	250	13		507074	507202		2	
654 SPORT	654	83			507203		118	
500 LS	500	77			507203		118	
500 QUATTRO	500	76			507203		118	
750 SEI	750	75			507203		118	
900 SEI	900	78			507209		188	
125 BKX	125	88		507077	507212	507151	6	
VELVET 125	125	98	10	507102	507239	507156	3	
VELVET 150	150	98		507102	507239	507156	3	
VELVET 125	125	11		507102	507239	507156	3	
CIVITAS 125	125	20			507320		145	
510 ENDURO	510	8			507320		145	
570 SUPERMOTO	570	8			507320		145	
HOBBY 125	125	13		507107	507246	507158	102	
HOBBY 150	150	13		507107	507246	507158	102	
MACIS 125	125	8		507107	507246	507158	102	
MACIS 150	150	10		507107	507246	507158	102	
BN 302	302	14		507115	507251	507163	66	
666	125	98		507116	507252	507164	14	
756	750	10		507116	507252	507164	14	
BN 600	600	13		507116	507252	507164	14	
TNT 1130	1130	4		507116	507252	507164	14	
TNT 899 S/T	900	8	10	507116	507252	507164	14	
TRE-K 899	900	9		507116	507252	507164	14	
TREK AMAZONAS	1130	7		507116	507252	507164	14	
CENTURY RACER 899	900	11		507116	507252	507164	14	
DUE	750	7		507116	507252	507164	14	
SPORT TORNADO NAKED TRE	1130	6		507116	507252	507164	14	
TNT 899	900	11		507116	507252	507164	14	
TNT CAFÉ RACER	1130	6		507116	507252	507164	14	
TNT R 160	1130	10		507116	507252	507164	14	
TNT TITANIUM	1130	6		507116	507252	507164	14	
TORNADO TRE 1130	1130	6		507116	507252	507164	14	
TORNADO TRE 900 LM	900	3		507116	507252	507164	14	
1200 GT	1200	21		507116	507252	507164	14	
502 C	502	19		507116	507252	507164	14	
BN 600 GT	600	15		507116	507252	507164	14	

 Plaquettes arrière			 Mâchoires arrière	
SEMI MÉTALLIQUES G1050	SEMI MÉTALLIQUES G1054	SINTERED G1380	N° Schéma	G2165
507084	507220		91	
507084	507220		91	
507084	507220		91	
507084	507220		91	
	507324		149	
	507324		149	
507074	507202		2	
	507203		118	
	507203		118	
	507203		118	
	507203		118	
507074	507202		2	
507102	507239	507156	3	
507102	507239	507156	3	
		507181	37	
507079	507214		38	
507143	507230	507154	48	
	507347		161	
507107	507246	507158	102	
507107	507246	507158	102	
507107	507246	507158	102	
507107	507246	507158	102	
507078	507213		87	
	507324		149	
	507324		149	
	507324		149	
	507324		149	
	507324		149	
	507324		149	
	507347		161	
	507347		161	
	507347		161	
	507347		161	
	507347		161	
	507347		161	
	507347		161	
	507347		161	
	507347		161	
	507347		161	
	507347		161	
	507347		161	
	507347		161	
	507199		83	
	507199		83	
	507199		83	

MOTEUR

CYCLE

PNEUMATIQUE

ATELIER

ACCESSOIRES

ÉLECTRICITÉ

FILTRATION

FREINAGE

TRANSMISSION

PLAQUETTES DE FREIN - MÂCHOIRES DE FREIN / BRAKE PADS - BRAKE SHOE

CGN
LE SENS DU DÉTAIL

MOTEUR

CYCLE

PNEUMATIQUE

ATELIER

ACCESSOIRES

ÉLECTRICITÉ

FILTRATION

FREINAGE

TRANSMISSION

Modèle	Cylindre	Depuis	Jusqu'à	GALFER MOTO			N° Schéma	Mâchoires avant G2165
				Plaquettes avant				
				SEMI MÉTALLIQUES G1050	SEMI MÉTALLIQUES G1054	SINTERED G1380		
BN 600 R	600	14		507116	507252	507164	14	
LEONCINO 800	800	20		507116	507252	507164	14	
LEONCINO 800 TRAIL	800	20		507116	507252	507164	14	
SRK 600	600	21		507116	507252	507164	14	
TRK 800	800	22		507116	507252	507164	14	
VELVET 250	250	99		507120	507256	507166	7	
VELVET DUSK 400	400	3		507120	507256	507166	7	
ADIVA	125	0		507127	507265		17	
ADIVA	150	0		507127	507265		17	
BX 449	449	7			507358		170	
CAFFE NERO DER.	250	8		507135	507272		77	
251 S	250	20		507142	507278	507174	67	
302 R	302	17		507142	507278	507174	67	
302 S	302	18		507142	507278	507174	67	
402 S	400	18		507142	507278	507174	67	
BKX 125	125	23		507142	507278	507174	67	
BKX 125 S	125	23		507142	507278	507174	67	
BKX 250	250	23		507142	507278	507174	67	
BKX 250 S	250	23		507142	507278	507174	67	
BN 251	250	14		507142	507278	507174	67	
LEONCINO 125	125	21		507142	507278	507174	67	
LEONCINO 250	250	18		507142	507278	507174	67	
TNT 300	300	16		507142	507278	507174	67	
TRK 251	250	18		507142	507278	507174	67	
TRK 302	302	20		507142	507278	507174	67	
TRK 502 X	500	17		507142	507278	507174	67	
TRX 502	500	18		507142	507278	507174	67	
752 S	750	18	19	507142	507278	507174	67	
LEONCINO	500	17		507142	507278	507174	67	
LEONCINO CINQUECENTO	500	18		507142	507278	507174	67	
TRK 502	500	17		507142	507278	507174	67	
IMPERIALE 400	400	18		507142	507278	507174	67	
LEONCINO TRAIL	500	17		507142	507278	507174	67	
TORNADO NAKED 500 TWIN	500	23		507142	507278	507174	67	
TRK 702	702	23		507142	507278	507174	67	
TRK 702	702	23		507142	507278	507174	67	
752 S	750	20		507142	507278	507174	67	
125 E	125	86						
125 T 2C	125	76						
250 QUATTRO, TS	250	76						
304	304	83						
304	304	89						

PLAQUETTES DE FREIN - MÂCHOIRES DE FREIN / BRAKE PADS - BRAKE SHOE

MOTEUR

CYCLE

PNEUMATIQUE

ATELIER

ACCESSOIRES



ÉLECTRICITÉ

FILTRATION

FREINAGE

TRANSMISSION

Modèle	Cylindre	Depuis	Jusqu'à	Plaquettes avant			N° Schéma	Mâchoires avant G2165
				SEMI MÉTALLIQUES G1050	SEMI MÉTALLIQUES G1054	SINTERED G1380		
CAFFE NERO IQZ.	250	8						
BETA								
200 ALP	200	0	7	507077	507212	507151	6	
TR 34 R 260 SUPER TRIAL	260	89	92	507077	507212	507151	6	
ZERO	260	98		507077	507212	507151	6	
MOTARD 4.0	350	5	6	507081	507216		23	
ALP 4.0	350	3	7	507081	507216		23	
TR 34 125 c.c.	125	88	88	507150	507219		12	
TR 34 260 c.c.	260	88	88	507150	507219		12	
M 4	350	6			507300		125	
ALP 125	125	6	7		507300		125	
240 ALP	240	89	91					
240 ST	240	92						
SYNT 260	260	92	93					
TR 34 R 125 CAMPEONATO	125	89	90					
TR 34 R 260 CAMPEONATO	260	88	88					
TR 35 125	125	91						
TR 35 240 REVERSE	240	89	91					
TR 35 260 REVERSE	260	89	92					
ZERO	260	89	92					
ZERO 125	125	92						
SYNT 125	125	94		507100	507237		98	
SYNT 260	260	94		507100	507237		98	
TECHNO 250	250	94		507100	507237		98	
EIKON 125 4T	125	99		507102	507239	507156	3	
ZERO 93 GARA	260	93	97					
EURO	350	0			507320		145	
JONATHAN	125	0			507320		145	
JONATHAN	350	3			507320		145	
REV 3	125	0	4		507343		157	
REV 3	125	5	5		507343		157	
REV 3	250	0	4		507343		157	
REV 3	250	5	5	507118	507254		106	
EIKON 150 4T	150	99		507120	507256	507166	7	
REV 3	125	6						
REV 3	200	6						
REV 3	250	6						
REV 3	270	5						
REV 4T	250	7						
EVO 125	125	9	11					
EVO 125 MY12	125	12						
EVO 200	200	9	11					

 Plaquettes arrière			 Mâchoires arrière	
SEMI MÉTALLIQUES G1050	SEMI MÉTALLIQUES G1054	SINTERED G1380	N° Schéma	G2165
	507234	507180	90	
507077	507212	507151	6	
507077	507212	507151	6	
507077	507212	507151	6	
		507181	37	
	507294		119	
	507294		119	
		507181	37	
507077	507212	507151	6	
507077	507212	507151	6	
507077	507212	507151	6	
507077	507212	507151	6	
507077	507212	507151	6	
507077	507212	507151	6	
507077	507212	507151	6	
507077	507212	507151	6	
507077	507212	507151	6	
507077	507212	507151	6	
507077	507212	507151	6	
507077	507212	507151	6	
507077	507212	507151	6	
507102	507239	507156	3	
507077	507212	507151	6	
507078	507213		87	
507078	507213		87	
507078	507213		87	
	507343		157	
	507343		157	
	507343		157	
	507343		157	
507102	507239	507156	3	
	507343		157	
	507343		157	
	507343		157	
	507343		157	
	507343		157	
	507343		157	
	507343		157	
	507343		157	
	507343		157	

PLAQUETTES DE FREIN - MÂCHOIRES DE FREIN / BRAKE PADS - BRAKE SHOE

MOTEUR

CYCLE

PNEUMATIQUE

ATELIER

ACCESSOIRES

ÉLECTRICITÉ

FILTRATION

FREINAGE

TRANSMISSION

Modèle	Cylindre	Depuis	Jusqu'à	GALFER MOTO			GALFER MOTO	
				Plaquettes avant			Mâchoires avant	
				SEMI MÉTALLIQUES G1050	SEMI MÉTALLIQUES G1054	SINTERED G1380	N° Schéma	G2165
EVO 200 MY12	200	12						
EVO 250 2T	250	9	11					
EVO 250 2T MY12	250	12						
EVO 250 4T	250	9	11					
EVO 250 4T MY12	250	12						
EVO 290 2T	290	9						
EVO 300 2T MY12	300	12						
EVO 300 4T	300	9						
EVO 300 4T MY12	300	12						
MOTARD 4.0	350	7			507200		57	
200 ALP	200	8			507200		57	
ALP 125	125	8			507200		57	
ALP 4.0	350	8			507200		57	
RR 125 4T	125	6			507200		57	
RR 125 4T SM	125	6			507200		57	
RR ENDURO	125	8			507200		57	
RR MOTARD	125	8			507200		57	
URBAN 125	125	8			507200		57	
URBAN 200	200	8			507200		57	
125 ENDURO RR	125	20			507200		57	
200 ENDURO RR	200	20			507200		57	
250 RR 2T ENDURO	250	12			507200		57	
250 RR 4T	250	5			507200		57	
300 RR 2T ENDURO	300	13			507200		57	
350 RR 4T	350	11	12		507200		57	
350 RR 4T ENDURO	350	13			507200		57	
350 RR efi	350	15			507200		57	
390 RR 4T	390	15			507200		57	
400 RR 4T	400	5	12		507200		57	
400 RR 4T ENDURO	400	13			507200		57	
430 RR 4T	430	15			507200		57	
450 RR 4T	450	5	12		507200		57	
450 RR 4T ENDURO	450	13			507200		57	
480 RR 4T	480	15			507200		57	
498 RR 4T	498	12	12		507200		57	
498 RR 4T ENDURO	498	13			507200		57	
525 RR 4T	525	5			507200		57	
XTRAINER	300	15			507200		57	
X-TRAINER	250	18			507200		57	
RR S	125	18			507200		57	
RR S MOTARD	125	18			507200		57	
240 TR 33	240	86	87					

GALFER MOTO			GALFER MOTO	
Plaquettes arrière			Mâchoires arrière	
SEMI MÉTALLIQUES G1050	SEMI MÉTALLIQUES G1054	SINTERED G1380	N° Schéma	G2165
	507343		157	
	507343		157	
	507343		157	
	507343		157	
	507343		157	
	507343		157	
	507343		157	
	507343		157	
	507343		157	
		507181	37	
		507181	37	
		507181	37	
		507181	37	
		507181	37	
		507181	37	
		507181	37	
		507181	37	
		507181	37	
	507319		144	
	507319		144	
	507319		144	
	507319		144	
	507319		144	
	507319		144	
	507319		144	
	507319		144	
	507319		144	
	507319		144	
	507319		144	
	507319		144	
	507319		144	
	507319		144	
	507319		144	
	507319		144	
	507319		144	
	507319		144	
	507319		144	
	507319		144	
	507319		144	
	507319		144	
	507319		144	
	507319		144	
	507319		144	
507123	507259	507183	50	
507123	507259	507183	50	
	507294		119	

MOTEUR

CYCLE

PNEUMATIQUE

ATELIER

ACCESSOIRES

ÉLECTRICITÉ



FILTRATION

FREINAGE

TRANSMISSION

PLAQUETTES DE FREIN - MÂCHOIRES DE FREIN / BRAKE PADS - BRAKE SHOE

Modèle	Cylindre	Depuis	Jusqu'à	GALFER MOTO			GALFER MOTO	
				Plaquettes avant			Mâchoires avant	
				SEMI MÉTALLIQUES G1050	SEMI MÉTALLIQUES G1054	SINTERED G1380	N° Schéma	G2165
240 TR 33 TREKKING	240	88	88					
250 AFRICA	250	86						
250 CR	250	83						
KR 125	125	86	86					
KR 125 AFRICA	125	87						
KR 250	250	86	86					
KR 250 RALLY	250	87						
TR 32 125	125	86	86					
TR 33 125	125	87	87					
BIMOTA								
YB5	1200	87		507074	507202		2	
BBI SUPERMONO	650	95		507074	507202		2	
BELLARIA	600	90		507074	507202		2	
DB1 RS	750	87		507074	507202		2	
DB2 H.F, SR, INJECTION	904	93		507074	507202		2	
DIECI	1000	91		507074	507202		2	
DIECI BIPOSTO	1000	92	95	507074	507202		2	
MANTRA 900	900	95		507074	507202		2	
SB 6 750	750	94		507074	507202		2	
SB6	1100	98		507074	507202		2	
SB7 1100	1100	94		507074	507202		2	
SB8 R SPECIAL	996	97		507074	507202		2	
TESI 1D 851	851	90	91	507074	507202		2	
TESI 1D 906 SR, ES, EF	904	93		507074	507202		2	
TESI 2D	992	6		507074	507202		2	
TESI 2D	1000	5		507074	507202		2	
TUATARA 1100	1100	90		507074	507202		2	
V-DUE 500	500	98		507074	507202		2	
YB10 BIPOSTO	1000	93		507074	507202		2	
YB4	750	87		507074	507202		2	
YB6	1000	87		507074	507202		2	
YB8	1000	90		507074	507202		2	
YB8 EVOLUTION	1000	93		507074	507202		2	
YB8 EXUP	1000	91		507074	507202		2	
YB8 FURANO 1000	1000	92		507074	507202		2	
YB9 SUPERSPORT 600	600	93		507074	507202		2	
DB4	900	98	99	507074	507202		2	
V-DUE 500 EVOLUZIONE	500	0		507074	507202		2	
SB8 K SANTAMONICA	996	6		507074	507202		2	
DB1	750	85			507203		118	
HB2	1100	82			507203		118	
KB3	1000	81			507203		118	

 Plaquettes arrière			 Mâchoires arrière	
SEMI MÉTALLIQUES G1050	SEMI MÉTALLIQUES G1054	SINTERED G1380	N° Schéma	G2165
	507294		119	
507074	507202		2	
507074	507202		2	
507074	507202		2	
507074	507202		2	
507074	507202		2	
507074	507202		2	
	507294		119	
	507294		119	
	507209		188	
507078	507213		87	
507078	507213		87	
507078	507213		87	
507078	507213		87	
507078	507213		87	
507078	507213		87	
507078	507213		87	
507078	507213		87	
507078	507213		87	
507078	507213		87	
507078	507213		87	
507078	507213		87	
507078	507213		87	
507078	507213		87	
507078	507213		87	
507078	507213		87	
507078	507213		87	
507078	507213		87	
507078	507213		87	
507078	507213		87	
507078	507213		87	
507078	507213		87	
507078	507213		87	
507078	507213		87	
507078	507213		87	
	507324		149	
	507324		149	
	507347		161	
	507203		118	
	507203		118	
	507203		118	

MOTEUR

CYCLE

PNEUMATIQUE

ATELIER

ACCESSOIRES

ÉLECTRICITÉ

FILTRATION

FREINAGE

TRANSMISSION

PLAQUETTES DE FREIN - MÂCHOIRES DE FREIN / BRAKE PADS - BRAKE SHOE

MOTEUR

CYCLE

PNEUMATIQUE

ATELIER

ACCESSOIRES

ÉLECTRICITÉ

FILTRATION

FREINAGE

TRANSMISSION

Modèle	Cylindre	Depuis	Jusqu'à	GALFER MOTO Plaquettes avant			GALFER MOTO Mâchoires avant	
				SEMI MÉTALLIQUES G1050	SEMI MÉTALLIQUES G1054	SINTERED G1380	N° Schéma	G2165
SB3	750	80			507203		118	
SB4, S, SB	1100	80			507203		118	
SB5, S, SP	1100	85			507203		118	
YB4 750	750	89			507203		118	
YB6 1000	1000	89			507203		118	
YB7 400	400	89			507203		118	
YB5 FS 1200	1200	87						
DBx	1100	13			507322		147	
DB 11 / VLX	1198	13		507116	507252	507164	14	
DB 7	1100	9		507116	507252	507164	14	
DB 8	1198	10		507116	507252	507164	14	
DB 8 SP	1198	13		507116	507252	507164	14	
KB4	1000	22		507116	507252	507164	14	
KB4 RC	1000	22		507116	507252	507164	14	
DB 10	1100	12		507116	507252	507164	14	
DB 12 B.TOURIST	1198	13		507116	507252	507164	14	
DB 5 R / S	990	10		507116	507252	507164	14	
DB 6 / R	990	10		507116	507252	507164	14	
DB 6 RE / E	1100	12		507116	507252	507164	14	
DB 7	1100	8	8	507116	507252	507164	14	
DB5 MILLE	992	5		507116	507252	507164	14	
DELIRIO	1000	7		507116	507252	507164	14	
TESI 3D	1000	7		507116	507252	507164	14	
TESI 3D	1100	8		507116	507252	507164	14	
BLANEY 4 WHEELS								
XC 125 TROJAN	125	3		507079	507214		38	
XL 200 TROOPER	200	3		507088	507225		31	
BLATA								
ENDURO 125	125	7		507077	507212	507151	6	
MOTARD 125	125	7		507077	507212	507151	6	
BMW								
K 100 RS, RT, LT	1000	87			507203		118	
K 100, RS, RT	1000	83	86		507203		118	
K 75	750	93			507203		118	
R 100 CS	1000	81			507203		118	
R 100 RS, RT, TT	1000	81			507203		118	
R 90 TT	900	81			507203		118	
R 100 S, T, RS, TR	1000	78			507203		118	
R 80/7	800	79			507203		118	
K 1100 LT (ABS)	1100	93	94		507203		118	
K 1100 RS ABS	1100	93			507203		118	
K1 ABS	1000	89			507203		118	

GALFER MOTO			GALFER MOTO	
Plaquettes arrière			Mâchoires arrière	
SEMI MÉTALLIQUES G1050	SEMI MÉTALLIQUES G1054	SINTERED G1380	N° Schéma	G2165
	507203		118	
	507203		118	
	507203		118	
507084	507220		91	
507084	507220		91	
507084	507220		91	
	507203		118	
	507322		147	
	507347		161	
	507347		161	
	507347		161	
	507347		161	
	507347		161	
	507347		161	
	507347		161	
	507347		161	
	507347		161	
	507347		161	
507137	507274		21	
507137	507274		21	
	507203		118	
	507203		118	
	507203		118	
	507203		118	
	507203		118	
	507203		118	
	507327		152	
	507327		152	
	507327		152	

PLAQUETTES DE FREIN - MÂCHOIRES DE FREIN / BRAKE PADS - BRAKE SHOE

MOTEUR

CYCLE

PNEUMATIQUE

ATELIER

ACCESSOIRES

ÉLECTRICITÉ

FILTRATION

FREINAGE

TRANSMISSION

Modèle	Cylindre	Depuis	Jusqu'à	GALFER MOTO			N° Schéma	Mâchoires avant G2165
				Plaquettes avant				
				SEMI MÉTALLIQUES G1050	SEMI MÉTALLIQUES G1054	SINTERED G1380		
R 100 GS, R	1000	93	94		507203		118	
R 1100 LT	1100	95			507203		118	
R 1100 RS	1100	93	94		507203		118	
K 1200 GT	1200	2	5		507203		118	
K 1200 RS	1200	1			507203		118	
K 75 RT, S	750	93			507209		188	
K 1100 LT SPECIAL EDITION	1100	95			507209		188	
HP 4	1000	12	17		507320		145	
HP 4 RACE	1000	18			507320		145	
S 1000 R NAKED	1000	14	19		507320		145	
S 1000 R NAKED	1000	21			507320		145	
S 1000 R NAKED FORGED WHEELS	1000	17	23		507320		145	
S 1000 RR ABS	1000	19	20		507320		145	
S 1000 RR ABS	1000	21			507320		145	
S 1000 RR ABS FORGED WHEELS	1000	9	18		507320		145	
S 1000 RR ABS OE WHEELS	1000	9	18		507320		145	
S 1000 RR FORGED WHEELS	1000	9	18		507320		145	
S 1000 RR OE WHEELS	1000	9	18		507320		145	
CI 125	125	0			507320		145	
CI 200	200	1			507320		145	
F 650	650	93			507320		145	
F 650 CS SCARVER	650	1			507320		145	
F 650 DAKAR	650	0	1		507320		145	
F 650 GS	650	0			507320		145	
F 650 GS BICILINDRICO	650	7			507320		145	
F 650 ST	650	97			507320		145	
F 700 GS	700	13			507320		145	
F 750 GS	750	18			507320		145	
F 750 GS EDICION 40	750	20			507320		145	
F 800 GS	800	8			507320		145	
F 800 GS ADVENTURE	800	22			507320		145	
F 850 GS	850	18			507320		145	
G 650 GS	650	9			507320		145	
G 650 XCHALLENGE	650	7			507320		145	
G 650 XCOUNTRY	650	7			507320		145	
F 800 GT	800	13			507320		145	
F 800 R	800	9	14		507320		145	
F 800 S	800	6			507320		145	
F 800 ST	800	6			507320		145	
G 650 XMOTO	650	7			507320		145	
C 400 GT	400	19			507320		145	
C 400 X	400	18			507320		145	

PLAQUETTES DE FREIN - MÂCHOIRES DE FREIN / BRAKE PADS - BRAKE SHOE

MOTEUR

CYCLE

PNEUMATIQUE

ATELIER

ACCESSOIRES



ÉLECTRICITÉ

FILTRATION

FREINAGE

TRANSMISSION

Modèle	Cylindre	Depuis	Jusqu'à	GALFER MOTO			N° Schéma	Mâchoires avant G2165
				Plaquettes avant				
				SEMI MÉTALLIQUES G1050	SEMI MÉTALLIQUES G1054	SINTERED G1380		
CE 4	EL	22			507320		145	
G 310 GS	310	17			507320		145	
G 310 R	310	16			507320		145	
F 800 R	800	15			507320		145	
F 900 R	900	20			507320		145	
F 900 XR	900	20			507320		145	
F 900 XR SPORT	900	20			507320		145	
S 1000 R NAKED	1000	20	20		507320		145	
R 1250 GS	1250	19			507322		147	
R 1250 GS ADVENTURE	1250	19			507322		147	
R 1250 RT	1250	19			507322		147	
R 1250 RT SPORT	1250	19			507322		147	
K 1600 B	1600	17			507322		147	
K 1600 GRAND AMERICA	1600	18			507322		147	
K 1600 GT	1600	11			507322		147	
K 1600 GT SE	1600	12			507322		147	
K 1600 GTL	1600	11			507322		147	
K 1600 GTL E	1600	12			507322		147	
R 1200 GS LC	1200	13			507322		147	
R 1200 GS LC ADVENTURE	1200	13			507322		147	
R 1200 R	1200	15			507322		147	
R 1200 RS	1200	15			507322		147	
R 1200 RT LC	1200	14			507322		147	
R 1250 R	1250	19			507322		147	
R 1250 RS	1250	19			507322		147	
HP 2 SPORT	1150	8			507326		151	
S 1000 XR (BREMBO CALIPERS)	1000	20			507326		151	
S 1000 XR (HAYES CALIPERS)	1000	20			507326		151	
S 1000 XR (M WHEELS) (BREMBO CALIPERS)	1000	20			507326		151	
S 1000 XR (M WHEELS) (HAYES CALIPERS)	1000	20			507326		151	
HP 2 ENDURO	1150	5			507326		151	
HP 2 SM	1150	6	6		507326		151	
R 1200 R NINE T PURE	1200	17			507326		151	
R 1200 R NINE T RACER	1200	17			507326		151	
R 1200 R NINE T SCRAMBLER	1200	16			507326		151	
R 1200 R NINE T URBAN G/S	1200	18			507326		151	
K 1200 RS ABS	1200	97	0		507326		151	
R 100 GS/ABS, R, RS	1000	95			507326		151	
R 100 R CLASSIC, MYSTIC	1000	95			507326		151	
R 1100 GS ABS	1100	94			507326		151	
R 1100 GS NO ABS	1100	94			507326		151	

 Plaquettes arrière			 Mâchoires arrière	
SEMI MÉTALLIQUES G1050	SEMI MÉTALLIQUES G1054	SINTERED G1380	N° Schéma	G2165
	507370		186	
	507370		186	
	507370		186	
	507199		83	
	507199		83	
	507199		83	
	507199		83	
	507199		83	
	507199		83	
	507353		165	
	507353		165	
	507353		165	
	507353		165	
	507353		165	
	507353		165	
	507199		83	
	507199		83	
	507199		83	
	507199		83	
	507199		83	
	507199		83	
	507322		147	
	507322		147	
	507324		149	
	507324		149	
	507324		149	
	507324		149	
	507327		152	
	507327		152	
	507327		152	
	507327		152	
	507327		152	

MOTEUR

CYCLE

PNEUMATIQUE

ATELIER

ACCESSOIRES

ÉLECTRICITÉ

FILTRATION

FREINAGE

TRANSMISSION

PLAQUETTES DE FREIN - MÂCHOIRES DE FREIN / BRAKE PADS - BRAKE SHOE

Modèle	Cylindre	Depuis	Jusqu'à	GALFER MOTO			GALFER MOTO	
				Plaquettes avant			Mâchoires avant	
				SEMI MÉTALLIQUES G1050	SEMI MÉTALLIQUES G1054	SINTERED G1380	N° Schéma	G2165
R 1100 R ROADSTER	1100	95			507326		151	
R 1100 RS NO ABS	1100	95			507326		151	
R 1100 RT ABS	1100	94	1		507326		151	
R 1100 RT NO ABS	1100	94	1		507326		151	
R 1100 S NO ABS	1100	98	0		507326		151	
R 1150 GS ABS	1150	0	1		507326		151	
R 1200 C AVANTGARDE	1200	0			507326		151	
R 1200 C INDEPENDENT	1200	1			507326		151	
R 1200 CRUISER	1200	97			507326		151	
R 850 R ROADSTER	850	95	0		507326		151	
HP 2 MEGAMOTO	1150	7			507326		151	
K 1200 RT	1200	6			507326		151	
K 1200 S	1200	4			507326		151	
K 1200 ST	1200	6	8		507326		151	
K 1200 ST	1200	9			507326		151	
K 1300 GT	1300	9			507326		151	
K 1300 S	1300	9			507326		151	
R 1100 S	1100	1			507326		151	
R 1150 GS	1150	2			507326		151	
R 1150 RT	1150	1			507326		151	
R 1200 GS	1200	4	8		507326		151	
R 1200 GS	1200	9			507326		151	
R 1200 GS ADVENTURE	1200	6	8		507326		151	
R 1200 GS ADVENTURE	1200	9			507326		151	
R 1200 RT	1200	5			507326		151	
R 1200 RT SE	1200	10			507326		151	
R 1200 S	1200	6	8		507326		151	
R 1200 S	1200	9			507326		151	
R 1200 ST	1200	5	8		507326		151	
R 1200 ST	1200	9			507326		151	
R 850 R ROADSTER	850	1			507326		151	
R 850 RT	850	6			507326		151	
K 1200 R	1200	5			507326		151	
K 1200 R SPORT	1200	7			507326		151	
K 1300 R	1300	9			507326		151	
R 1100 S ABS	1100	1			507326		151	
R 1150 GS ADVENTURE	1150	3			507326		151	
R 1150 R ROADSTER	1150	1			507326		151	
R 1150 R ROCKESTER	1150	3			507326		151	
R 1150 RS	1150	1			507326		151	
R 1200 C MONTAUK	1200	4			507326		151	
R 1200 R	1200	6	8		507326		151	

GALFER MOTO Plaquettes arrière			GALFER MOTO Mâchoires arrière	
SEMI MÉTALLIQUES G1050	SEMI MÉTALLIQUES G1054	SINTERED G1380	N° Schéma	G2165
	507327		152	
	507327		152	
	507327		152	
	507327		152	
	507327		152	
	507327		152	
	507327		152	
	507327		152	
	507327		152	
	507327		152	
	507351		164	
	507351		164	
	507351		164	
	507351		164	
	507351		164	
	507351		164	
	507351		164	
	507351		164	
	507351		164	
	507351		164	
	507351		164	
	507351		164	
	507351		164	
	507351		164	
	507351		164	
	507351		164	
	507351		164	
	507351		164	
	507353		165	
	507353		165	
	507353		165	
	507353		165	
	507353		165	
	507353		165	
	507353		165	
	507353		165	
	507353		165	
	507353		165	
	507353		165	
	507353		165	
	507353		165	

PLAQUETTES DE FREIN - MÂCHOIRES DE FREIN / BRAKE PADS - BRAKE SHOE

MOTEUR

CYCLE

PNEUMATIQUE

ATELIER

ACCESSOIRES

ÉLECTRICITÉ

FILTRATION

FREINAGE

TRANSMISSION

Modèle	Cylindre	Depuis	Jusqu'à	GALFER MOTO			N° Schéma	Mâchoires avant G2165
				Plaquettes avant				
				SEMI MÉTALLIQUES G1050	SEMI MÉTALLIQUES G1054	SINTERED G1380		
R 1200 R	1200	9	14		507326		151	
R 850 R	850	4			507326		151	
K 1300 S MOTOR SPORT	1300	15			507326		151	
R 1200 R NINE T	1200	14			507326		151	
S 1000 XR	1000	15	19		507326		151	
S 1000 XR (HP WHEELS)	1000	17	19		507326		151	
K 1200 LT	1200	97	0		507345		159	
K 1200 LT	1200	1	8		507345		159	
K 1200 LT	1200	9			507345		159	
C 600 SPORT	600	12		507128	507167		44	
C 650 GT	650	12		507128	507167		44	
C 650 MOTORSPORT	650	19		507128	507167		44	
C EVOLUTION	EL	14		507128	507167		44	
G 450 X	450	8			507358		170	
SPORT ENDURO 450	450	8			507358		170	
K 75 C	750	85	86					
K 75 C, S	750	87	92					
R 100	1000	89						
R 100 GS	1000	88	92				16	507387
R 100 GS, PD, RT	1000	93	94				16	507387
R 100 ROADSTER	1000	93						
R 100 RS	1000	81	82				16	507387
R 45	450	81	86				16	507387
R 65	650	81					16	507387
R 65	650		80					
R 65 LS	650	82	88				16	507387
R 65 LS	650	81						
R 65 R	650	93					16	507387
R 80 G, S	800	88	92				16	507387
R 80 GS	800	93					16	507387
R 80 GS, PARIS DAKAR	800	81	87				16	507387
R 80 R	800	94						
R 80 R ROADSTER	800	93						
R 80 RT	800	83	92					
R 80 RT	800	93						
R 80 RT	800	81	82				16	507387
R 80 ST, PD, GS	800	81					16	507387
RT 80 RT	800	91						
K 1200 GT IZQ/LEFT	1200	6						
BOMBARDIER 4 WHEELS								
RALLY 200	200	3	4					
TRAXTER 500 XL / XT	500	0		507116	507252	507164	14	

GALFER MOTO			GALFER MOTO	
Plaquettes arrière			Mâchoires arrière	
SEMI MÉTALLIQUES G1050	SEMI MÉTALLIQUES G1054	SINTERED G1380	N° Schéma	G2165
	507353		165	
	507353		165	
	507199		83	
	507199		83	
	507199		83	
	507199		83	
	507327		152	
	507353		165	
	507353		165	
507128	507167		44	
507128	507167		44	
507128	507167		44	
507128	507167		44	
507143	507230	507154	48	
507143	507230	507154	48	
	507203		118	
	507203		118	
	507209		188	
	507209		188	
	507209		188	
	507327		152	
	507203		118	
	507203		118	
	507203		118	
	507203		118	
	507203		118	
	507203		118	
	507209		188	
	507209		188	
	507209		188	
	507209		188	
	507203		118	
	507327		152	
	507327		152	
	507203		118	
	507209		188	
	507203		118	
	507203		118	
	507209		188	
	507351		164	
507085	507222	507152	25	
507116	507252	507164	14	

PLAQUETTES DE FREIN - MÂCHOIRES DE FREIN / BRAKE PADS - BRAKE SHOE

Modèle	Cylindre	Depuis	Jusqu'à	GALFER MOTO Plaquettes avant			N° Schéma	Mâchoires avant G2165
				SEMI MÉTALLIQUES G1050	SEMI MÉTALLIQUES G1054	SINTERED G1380		
RALLY 200	200	5		507135	507272		77	
DS 650 / BAJA IZQ.	650	0		507135	507272		77	
OUTLANDER 800 IZQ.	800	6		507135	507272		77	
QUEST 500/600 IZQ.	650	2		507135	507272		77	
OUTLANDER 330 IZQ.	330	4		507135	507272		77	
OUTLANDER 400 IZQ.	400	3		507135	507272		77	
OUTLANDER 400 IZQ. MAX	400	3		507135	507272		77	
TRAXTER MAX 650 IZQ.	650	4			507204		174	
OUTLANDER 330 DER.	330	4						
OUTLANDER 400 DER.	400	3						
OUTLANDER 400 DER. MAX	400	3						
DS 650 / BAJA DER.	650	0						
OUTLANDER 800 DER.	800	6						
QUEST 500/600 DER.	650	2						
TRAXTER MAX 650 DER.	650	4						
BORILE								
B 500 CR	500	2			507320		145	
B 500 MT	500	2			507320		145	
BRAKTEC								
SERIE 213FR	TRAS			507077	507212	507151	6	
SERIE 213RR	TRAS			507077	507212	507151	6	
SERIE 223	TRAS			507118	507254		106	
SERIE 215	TRAS					507184	61	
OFF ROAD 1P	TRAS				507358		170	
SERIE 242	TRAS				507200		57	
SERIE 284	TRAS				507200		57	
SERIE 210	DEL							
OFF ROAD 2P	DEL							
SERIE 280	DEL							
SERIE 235	DEL							
SERIE 245	DEL							
SERIE 222	DEL							
SERIE 282	DEL							
SERIE 254	DEL							
BRAMMO								
ENERTIA	EL	19		507116	507252	507164	14	
ENERTIA PLUS	EL	19		507116	507252	507164	14	
EMPULSE	EL	19		507116	507252	507164	14	
EMPULSE R	EL	19		507116	507252	507164	14	
BREMBO CUSTOM								
120B814**	DEL							

Plaquettes arrière			Mâchoires arrière	
SEMI MÉTALLIQUES G1050	SEMI MÉTALLIQUES G1054	SINTERED G1380	N° Schéma	G2165
507085	507222	507152	25	
507135	507272		77	
507135	507272		77	
507135	507272		77	
	507204		174	
	507204		174	
	507204		174	
507135	507272		77	
507135	507272		77	
507135	507272		77	
507135	507272		77	
	507204		174	
	507204		174	
	507204		174	
	507204		174	
507078	507213		87	
507078	507213		87	
507077	507212	507151	6	
507143	507230	507154	48	
507143	507230	507154	48	
		507181	37	
507116	507252	507164	14	
	507343		157	
	507343		157	
507137	507274		21	
	507322		147	
	507322		147	
	507324		149	
	507324		149	
	507347		161	

MOTEUR

CYCLE

PNEUMATIQUE

ATELIER

ACCESSOIRES

ÉLECTRICITÉ

FILTRATION

FREINAGE

TRANSMISSION

PLAQUETTES DE FREIN - MÂCHOIRES DE FREIN / BRAKE PADS - BRAKE SHOE

MOTEUR

CYCLE

PNEUMATIQUE

ATELIER

ACCESSOIRES

ÉLECTRICITÉ

FILTRATION

FREINAGE

TRANSMISSION

Modèle	Cylindre	Depuis	Jusqu'à	GALFER MOTO Plaquettes avant			N° Schéma	GALFER MOTO Mâchoires avant G2165
				SEMI MÉTALLIQUES G1050	SEMI MÉTALLIQUES G1054	SINTERED G1380		
BREMBO OFF ROAD								
XQ21390	TRAS				507358		170	
I22A99021	DEL							
XQ21361	DEL							
BREMBO RACING								
120A44110	TRAS			507116	507252	507164	14	
120B27810	TRAS			507116	507252	507164	14	
120B765**	DEL							
129B766**	DEL							
220A016**	DEL							
220A168**	DEL							
BRIXTON								
BX 125	125	19		507088	507225		31	
CROMWELL 125	125	21		507088	507225		31	
CROMWELL 250	250	21		507088	507225		31	
FELSBURG 125 X	125	19		507088	507225		31	
FELSBURG 250	250	21		507088	507225		31	
GLANVILLE 250 X	250	19		507088	507225		31	
RAYBURN 125	125	21		507088	507225		31	
SAXBY 250	250	19		507088	507225		31	
SUNRAY 125	125	21		507088	507225		31	
CROMWELL 1200	1200	21		507088	507225		31	
BUELL								
M2 CYCLONE	1200	0			507305		130	
S3 THUNDERBOLT	1200	0			507305		130	
SPECIAL M2 CYCLONE	1200	0			507305		130	
X1 LIGHTNING	1200	0			507305		130	
XB 12 R FIREBOLT	1200	9			507305		130	
XB 12 R FIREBOLT	1200	6	8		507305		130	
XB 12 S LIGHTNING	1200	6	8		507305		130	
XB 12 SS LIGHTNING LONG	1200	9			507305		130	
XB 12 SS LIGHTNING LONG	1200	6	8		507305		130	
XB 12 X ULYSSES	1200	6	8		507305		130	
XB 12 XT ULYSSES	1200	9	10		507305		130	
XB 9 R FIREBOLT F	984	2	7		507305		130	
XB 9 S LIGHTNING F	984	3	4		507305		130	
XB 9 SX CITYX	984	6	9		507305		130	
BLAST	500	0			507305		130	
BULTACO								
250 GTS	250	75		507074	507202		2	
SHERCO 125	125	0		507077	507212	507151	6	
SHERCO 2.5	250	99		507077	507212	507151	6	

GALFER MOTO			GALFER MOTO	
Plaquettes arrière			Mâchoires arrière	
SEMI MÉTALLIQUES G1050	SEMI MÉTALLIQUES G1054	SINTERED G1380	N° Schéma	G2165
507143	507230	507154	48	
507143	507230	507154	48	
507078	507213		87	
507078	507213		87	
	507324		149	
	507324		149	
	507221		33	
	507221		33	
	507221		33	
	507221		33	
	507221		33	
	507221		33	
	507221		33	
	507221		33	
	507221		33	
507128	507167		44	
507094	507231		46	
507074	507202		2	
507077	507212	507151	6	
507077	507212	507151	6	

PLAQUETTES DE FREIN - MÂCHOIRES DE FREIN / BRAKE PADS - BRAKE SHOE

MOTEUR

CYCLE

PNEUMATIQUE

ATELIER

ACCESSOIRES



ÉLECTRICITÉ

FILTRATION

FREINAGE

TRANSMISSION

Modèle	Cylindre	Depuis	Jusqu'à	GALFER MOTO			N° Schéma	Mâchoires avant G2165
				Plaquettes avant				
				SEMI MÉTALLIQUES G1050	SEMI MÉTALLIQUES G1054	SINTERED G1380		
SHERCO 200	200	0		507077	507212	507151	6	
SHERCO 290	290	0		507077	507212	507151	6	
CAGIVA								
ALAZURRA 350	350	84		507074	507202		2	
TOURING 650	650	86		507074	507202		2	
DAKAR 750	750	87		507074	507202		2	
ELEFANT 650	650	87		507074	507202		2	
ELEFANT 750	750	87	93	507074	507202		2	
LUCKY EXPLORER 750	750	88		507074	507202		2	
MITO 125 EDDY	125	93		507074	507202		2	
MITO 125 SP 525	125	8		507074	507202		2	
MITO 500	500	7	7	507074	507202		2	
PLANET 125	125	98		507074	507202		2	
RAPTOR 125	125	3		507074	507202		2	
RIVER 600	600	95		507074	507202		2	
ALAZURRA GT 650	650	87		507074	507202		2	
BLUS 125	125	88	92	507074	507202		2	
ELEFANT 350	350	83		507074	507202		2	
PARIS DAKAR 650	650	86		507074	507202		2	
FRECCIA 125	125	87		507074	507202		2	
FRECCIA C- 9 125	125	88	88	507074	507202		2	
W8 125	125	92		507074	507202		2	
FRECCIA C-10 125	125	88	88	507074	507202		2	
FRECCIA C-10 125 ANIVERSARIO	125	89		507074	507202		2	
FRECCIA C-12 R 125	125	89		507074	507202		2	
MITO 125 CORSA	125	89	94	507074	507202		2	
SUPER CITY 125	125	91		507074	507202		2	
MITO 500	500	8		507074	507202		2	
ALETTA ORO 125 S2	125	86		507075	507210		4	
BLUS 125	125	93		507075	507210		4	
CRUISER 125	125	87	87	507075	507210		4	
CRUISER 125	125	88		507075	507210		4	
W8 PRO ACTION	125	91		507075	507210		4	
TAMANACO 125	125	89		507075	507210		4	
K7 125 N90	125	91		507081	507216		23	
W 16 600	600	95		507081	507216		23	
WMX 125	125	90		507081	507216		23	
WMX 250	250	88	91	507081	507216		23	
ELEFANT 906	906	89	90		507221		33	
CANYON	500	99		507088	507225		31	
CANYON	600	95		507088	507225		31	
CANYON	900	97		507088	507225		31	

				
Plaquettes arrière			Mâchoires arrière	
SEMI MÉTALLIQUES G1050	SEMI MÉTALLIQUES G1054	SINTERED G1380	N° Schéma	G2165
507077	507212	507151	6	
507077	507212	507151	6	
507074	507202		2	
507074	507202		2	
507078	507213		87	
507078	507213		87	
507078	507213		87	
507078	507213		87	
507078	507213		87	
507078	507213		87	
507080	507215		88	
507080	507215		88	
507080	507215		88	
507080	507215		88	
	507298		123	
	507298		123	
	507298		123	
	507311		136	
	507311		136	
	507311		136	
	507311		136	
	507311		136	
	507311		136	
	507347		161	
507075	507210		4	
507080	507215		88	
	507298		123	
	507298		123	
	507298		123	
	507311		136	
	507298		123	
	507298		123	
	507298		123	
	507298		123	
	507301		126	
	507296		121	
	507314		139	
	507322		147	

PLAQUETTES DE FREIN - MÂCHOIRES DE FREIN / BRAKE PADS - BRAKE SHOE

MOTEUR

CYCLE

PNEUMATIQUE

ATELIER

ACCESSOIRES

ÉLECTRICITÉ

FILTRATION

FREINAGE

TRANSMISSION

Modèle	Cylindre	Depuis	Jusqu'à	GALFER MOTO Plaquettes avant			N° Schéma	Mâchoires avant G2165
				SEMI MÉTALLIQUES G1050	SEMI MÉTALLIQUES G1054	SINTERED G1380		
GRAN CANYON	900	99		507088	507225		31	
NAVIGATOR	1000	0		507088	507225		31	
W12 350	350	93		507091	507228		22	
ELEFANT 750	750	94		507143	507230	507154	48	
ELEFANT 900	900	94		507143	507230	507154	48	
ELEFANT 900 CATALITICA	900	93	93	507094	507231		46	
ELEFANT 900 i.e.	900	91	92		507234	507180	90	
RIVER 500	500	0		507105	507243		1	
RAPTOR	1000	0		507116	507252	507164	14	
V-RAPTOR	650	1		507116	507252	507164	14	
V-RAPTOR	1000	0		507116	507252	507164	14	
X-TRA RAPTOR	1000	2		507116	507252	507164	14	
250 ALA BLU	250	83						
350 E (T4)	350	88						
350 R (T4)	350	88						
500 E (T4)	500	88						
ALA BLU 350	350	83						
ALA ROSSA SXT 350	350	82						
ALA VERDE SST 350	350	81						
ALETTA ELECTRA 125	125	83						
ALETTA ELECTRA 200	200	83						
ALETTA ELECTRA TOURING	600	86						
CROSS 125	125	86						
CUCCIOLO	125	99						
E2 125	125	86						
E2 200	200	86						
ELECTRA 125	125	88						
ELEFANT 125	125	81						
ENDURO 125	125	86						
ENDURO 500	500	86						
MXR 250	250	82						
MXR 400	400	82						
MXR 500	500	82						
NUVOLA	125	0						
PASSING 125	125	95						
ROADSTER 125	125	93						
SST 125	125	81						
SST 250 ALA VERDE	250	81						
SX 350	350	83						
VRX 250	250	83						
WMR 500 GP	500	82						
WMX 125	125	88	89					

GALFER MOTO			GALFER MOTO	
Plaquettes arrière			Mâchoires arrière	
SEMI MÉTALLIQUES G1050	SEMI MÉTALLIQUES G1054	SINTERED G1380	N° Schéma	G2165
507128	507167		44	
507128	507167		44	
	507298		123	
507143	507230	507154	48	
507143	507230	507154	48	
507143	507230	507154	48	
	507296		121	
507078	507213		87	
	507324		149	
	507324		149	
	507324		149	
	507324		149	
507074	507202		2	
507074	507202		2	
507074	507202		2	
507074	507202		2	
507074	507202		2	
507074	507202		2	
507074	507202		2	
507075	507210		4	
507075	507210		4	
507075	507210		4	
507074	507202		2	
507105	507243		1	
507075	507210		4	
507075	507210		4	
507075	507210		4	
507075	507210		4	
507074	507202		2	
507074	507202		2	
507074	507202		2	
507074	507202		2	
507074	507202		2	
507105	507243		1	
507108	507247	507159	34	
507080	507215		88	
507075	507210		4	
507074	507202		2	
507074	507202		2	
507074	507202		2	
507074	507202		2	
	507298		123	

PLAQUETTES DE FREIN - MÂCHOIRES DE FREIN / BRAKE PADS - BRAKE SHOE

MOTEUR

CYCLE

PNEUMATIQUE

ATELIER

ACCESSOIRES



ÉLECTRICITÉ

FILTRATION

FREINAGE

TRANSMISSION

Modèle	Cylindre	Depuis	Jusqu'à	GALFER MOTO			N° Schéma	Mâchoires avant G2165
				Plaquettes avant				
				SEMI MÉTALLIQUES G1050	SEMI MÉTALLIQUES G1054	SINTERED G1380		
WMX 250 GP	250	82						
WSTX125 ALETTA ROSSA	125	83						
CAN-AM								
ASE 200, 250, 350, 406, 500	200	86						
MX, LC, 250, 500	250	86						
SONIC 560	560	86						
CAN-AM 4 WHEELS								
DS 450 X	450	8						
RALLY 200	200	7		507135	507272		77	
DS 650 X DER./RIGHT	650	7		507135	507272		77	
OUTLANDER 400 MAX STD/XT DER./RIGHT	400	7		507135	507272		77	
OUTLANDER 400 STD/XT DER./RIGHT	400	7		507135	507272		77	
OUTLANDER 500 MAX STD/XT DER./RIGHT	500	7		507135	507272		77	
OUTLANDER 500 STD/XT DER./RIGHT	500	7		507135	507272		77	
OUTLANDER 650 MAX STD/XT DER./RIGHT	650	7		507135	507272		77	
OUTLANDER 650 STD/XT DER./RIGHT	650	7		507135	507272		77	
OUTLANDER 800 MAX STD/XT DER./RIGHT	800	7		507135	507272		77	
OUTLANDER 800 STD/XT DER./RIGHT	800	7		507135	507272		77	
RENEGADE 800 HO efi DER./RIGHT	800	7		507135	507272		77	
DS 250	250	7			507363		179	
DS 650 X IZQ./LEFT	650	7						
OUTLANDER 400 MAX STD/XT IZQ./LEFT	400	7						
OUTLANDER 400 STD/XT IZQ./LEFT	400	7						
OUTLANDER 500 MAX STD/XT IZQ./LEFT	500	7						
OUTLANDER 500 STD/XT IZQ./LEFT	500	7						
OUTLANDER 650 MAX STD/XT IZQ./LEFT	650	7						
OUTLANDER 650 STD/XT IZQ./LEFT	650	7						
OUTLANDER 800 MAX STD/XT IZQ./LEFT	800	7						
OUTLANDER 800 STD/XT IZQ./LEFT	800	7						
RENEGADE 800 HO efi IZQ./LEFT	800	7						
CANNONDALE								
E 440	440	1			507310		135	
X 440	440	1			507310		135	
X 440 S	440	1			507310		135	
XC 400	400	1			507310		135	
CANNONDALE 4 WHEELS								
BLAZE 440 IZQ.	440	2		507135	507272		77	

				
Plaquettes arrière			Mâchoires arrière	
SEMI MÉTALLIQUES G1050	SEMI MÉTALLIQUES G1054	SINTERED G1380	N° Schéma	G2165
507074	507202		2	
507075	507210		4	
507074	507202		2	
507074	507202		2	
507074	507202		2	
507079	507214		38	
	507204		174	
	507204		174	
	507204		174	
	507204		174	
	507204		174	
	507204		174	
	507204		174	
	507204		174	
	507204		174	
	507204		174	
	507204		174	
	507204		174	
	507363		179	
507135	507272		77	
507135	507272		77	
507135	507272		77	
507135	507272		77	
507135	507272		77	
507135	507272		77	
507135	507272		77	
507135	507272		77	
507135	507272		77	
507135	507272		77	
	507319		144	
	507319		144	
	507319		144	
	507319		144	
507135	507272		77	

MOTEUR

CYCLE

PNEUMATIQUE

ATELIER

ACCESSOIRES

ÉLECTRICITÉ

FILTRATION

FREINAGE

TRANSMISSION

PLAQUETTES DE FREIN - MÂCHOIRES DE FREIN / BRAKE PADS - BRAKE SHOE

Modèle	Cylindre	Depuis	Jusqu'à	GALFER MOTO			N° Schéma	Mâchoires avant
				SEMI MÉTALLIQUES G1050	SEMI MÉTALLIQUES G1054	SINTERED G1380		
CANNIBAL 440 IZQ.	440	2		507135	507272		77	
FX 400 IZQ.	400	1		507135	507272		77	
GLAMIS 440 IZQ.	440	3		507135	507272		77	
MOTO 440 IZQ.	440	2		507135	507272		77	
SPEED 440 IZQ.	440	2		507135	507272		77	
BLAZE 440 DER.	440	2						
CANNIBAL 440 DER.	440	2						
FX 400 DER.	400	1						
GLAMIS 440 DER.	440	3						
MOTO 440 DER.	440	2						
SPEED 440 DER.	440	2						
CCM								
XTR 250	250	9		507082	507218		70	
C-XR 125 E	125	8		507086	507223		9	
C-XR 125 M	125	8		507086	507223		9	
C-XR 125 S	125	8		507086	507223		9	
C-XR 230 E	230	7		507086	507223		9	
C-XR 230 M	230	7		507086	507223		9	
C-XR 230 S	230	7		507086	507223		9	
TL 125	125	8			507234	507180	90	
SM 125	125	8			507234	507180	90	
404 DS	404	3			507320		145	
404 DS SUPER MOTARD	404	3			507320		145	
404 E	404	3			507320		145	
604 E DS	604	98	3		507320		145	
604 E SUPER MOTARD	604	98	3		507320		145	
604 RS ROADSTER	604	0	3		507320		145	
644 DS	644	4			507320		145	
644 DS SUPER MOTARD	644	4			507320		145	
FT 710	710	8			507320		145	
R 30	644	2			507320		145	
450 ADVENTURE	450	15			507320		145	
450 ADVENTURE SM	450	16			507320		145	
RL 125	125	8						
CCM 4 WHEELS								
LX 700 4 A	700	8						
LX 350 4 A	350	8		507081	507216		23	
CFMOTO								
E-CHARM	125	10		507082	507218		70	
E-CHARM	150	10		507082	507218		70	
CLX 700 SPORT	700	20		507143	507230	507154	48	
CLX 700	700	20		507143	507230	507154	48	

PLAQUETTES DE FREIN - MÂCHOIRES DE FREIN / BRAKE PADS - BRAKE SHOE

CGN
LE SENS DU DÉTAIL

MOTEUR

CYCLE

PNEUMATIQUE

ATELIER

ACCESSOIRES



ÉLECTRICITÉ

FILTRATION

FREINAGE

TRANSMISSION

Modèle	Cylindre	Depuis	Jusqu'à	GALFER MOTO			N° Schéma	Mâchoires avant	G2165
				Plaquettes avant					
				SEMI MÉTALLIQUES G1050	SEMI MÉTALLIQUES G1054	SINTERED G1380			
CLX 700 ADVENTURE	700	20		507143	507230	507154	48		
CLX 700 HERITAGE	700	20		507143	507230	507154	48		
CLX 700 X ADV	700	23		507143	507230	507154	48		
MT 800 SPORT	800	22		507143	507230	507154	48		
MT 800 TOURING	800	22		507143	507230	507154	48		
NK 700	700	20		507143	507230	507154	48		
TR-G 1250	1250	22			507320		145		
NK 250	250	20			507320		145		
NK 300	300	20			507320		145		
SR 250	250	21			507320		145		
SR 300	300	21			507320		145		
GT 650	650	20			507320		145		
MT 650	650	20			507320		145		
NK 400	400	20			507320		145		
NK 650 MT ADVENTURE TOURER	650	20			507320		145		
CLX 300	300	22			507320		145		
TK 650 IZQ/LEFT	650	16			507321		146		
NK 650	650	13			507321		146		
GLORY	125	10		507111	507328	507160	5		
GLORY	150	10		507111	507328	507160	5		
JET MAX IZQ/LEFT	250	10		507111	507328	507160	5		
MAGNET	EL	23		507116	507252	507164	14		
NK C22	800	23		507116	507252	507164	14		
PAPIO NOVA	EL	23							
SR 450	450	22							
JET MAX DER/RIGHT	250	10							
TK 650 DER/RIGHT	650	16							
CH RACING									
WSM 125 MOTARD	125	5		507077	507212	507151	6		
WXE 125 ENDURO	125	5		507077	507212	507151	6		
CLIPIC									
MINJ 125	125	6		507077	507212	507151	6		
MINJ 200	200	6		507077	507212	507151	6		
CPI									
SUPERMOTO 125	125	7		507077	507212	507151	6		
GTR 125	125	3		507102	507239	507156	3		
GTR 150	150	3		507102	507239	507156	3		
GTR 200	200	3		507102	507239	507156	3		
GTS 125	125	3		507102	507239	507156	3		
GTS 150	150	3		507102	507239	507156	3		
GTS 200	200	3		507102	507239	507156	3		
X-LARGE 125	125	3		507116	507252	507164	14		

				
Plaquettes arrière			Mâchoires arrière	
SEMI MÉTALLIQUES G1050	SEMI MÉTALLIQUES G1054	SINTERED G1380	N° Schéma	G2165
	507324		149	
	507324		149	
	507324		149	
	507324		149	
	507324		149	
	507324		149	
507095	507232	507155	62	
507095	507232	507155	62	
507095	507232	507155	62	
507095	507232	507155	62	
507128	507167		44	
507128	507167		44	
507128	507167		44	
507128	507167		44	
507137	507274		21	
	507323		148	
507128	507167		44	
507107	507246	507158	102	
507107	507246	507158	102	
507107	507246	507158	102	
	507324		149	
507143	507230	507154	48	
	507199		83	
	507234	507180	90	
	507325		150	
	507227	507153	39	
	507227	507153	39	
507077	507212	507151	6	
507077	507212	507151	6	
507077	507212	507151	6	
		507181	37	
		507181	37	
		507181	37	
		507181	37	
		507181	37	
		507181	37	
507116	507252	507164	14	

PLAQUETTES DE FREIN - MÂCHOIRES DE FREIN / BRAKE PADS - BRAKE SHOE

MOTEUR

CYCLE

PNEUMATIQUE

ATELIER

ACCESSOIRES



ÉLECTRICITÉ

FILTRATION

FREINAGE

TRANSMISSION

Modèle	Cylindre	Depuis	Jusqu'à	GALFER MOTO Plaquettes avant			N° Schéma	Mâchoires avant G2165
				SEMI MÉTALLIQUES G1050	SEMI MÉTALLIQUES G1054	SINTERED G1380		
X-LARGE 150	150	3		507116	507252	507164	14	
X-LARGE 250	250	3		507116	507252	507164	14	
ARAGON /GP 125	125	7					11	507382
CPI 4 WHEELS								
XS 250 QUAD	250	6		507088	507225		31	
CSR								
MAX	125	9			507234	507180	90	
ONA	125	4		507083	507244		19	
ONA	150	6		507083	507244		19	
SCOO	125	4		507083	507244		19	
SCOO	150	6		507083	507244		19	
DAELIM								
HISTORY	125	2		507086	507223		9	
NS 125 DXL	125	2		507086	507223		9	
S2 125 FREEWING	125	6	7	507086	507223		9	
B-BONE	125	8		507086	507223		9	
OTELLO f.i.	125	8		507086	507223		9	
S2 125 FREEWING f.i.	125	8		507086	507223		9	
ROADWIN 250	250	8	10	507088	507225		31	
ROADWIN 250 R.FI	250	11		507088	507225		31	
S2 250 FREEWAY	250	6		507088	507225		31	
DAYSTAR VL 125Z FI PLUS	125	14			507234	507180	90	
ROADWIN	125	3	10		507234	507180	90	
ROADWIN 125 R f.i	125	11			507234	507180	90	
S3 125 Fi	125	10	11		507234	507180	90	
S3 125 Fi	125	12	14	507145	507282	507187	111	
S3 250 Fi ADVANCE	250	12	14	507145	507282	507187	111	
AVANCE II	125	98						
BESBI	125	8						
DAYSTAR 125	125	0						
DELFINO 125	125	8						
NS 125	125	98	99					
NS 125 II	125	0	0					
NS 125 III	125	1	1					
VL DAYSTAR 125	125	2						
VS 125	125	98						
VT/VS CUSTOM	125	98						
DAELIM 4 WHEELS								
ET 250 QUAD	250	6		507145	507282	507187	111	
ET 300 QUAD	300	7		507145	507282	507187	111	
DERBI								
SENDA DRD 125 R RACING	125	6		507077	507212	507151	6	

 Plaquettes arrière			 Mâchoires arrière	
SEMI MÉTALLIQUES G1050	SEMI MÉTALLIQUES G1054	SINTERED G1380	N° Schéma	G2165
507116	507252	507164	14	
507116	507252	507164	14	
507083	507244		19	
	507363		179	
	507234	507180	90	
507083	507244		19	
507083	507244		19	
507083	507244		19	
507083	507244		19	
507086	507223		9	
507086	507223		9	
507094	507231		46	
507117	507253	507165	13	
507117	507253	507165	13	
507117	507253	507165	13	
507094	507231		46	
507094	507231		46	
507094	507231		46	
507094	507231		46	
507094	507231		46	
507094	507231		46	
507130	507267	507169	78	
507130	507267	507169	78	
507130	507267	507169	78	
507086	507223		9	
507097	507233		95	
507094	507231		46	
507088	507225		31	
507086	507223		9	
507086	507223		9	
507086	507223		9	
507094	507231		46	
507086	507223		9	
507094	507231		46	
507085	507222	507152	25	
507085	507222	507152	25	
		507181	37	

PLAQUETTES DE FREIN - MÂCHOIRES DE FREIN / BRAKE PADS - BRAKE SHOE

MOTEUR

CYCLE

PNEUMATIQUE

ATELIER

ACCESSOIRES



ÉLECTRICITÉ

FILTRATION

FREINAGE

TRANSMISSION

Modèle	Cylindre	Depuis	Jusqu'à	GALFER MOTO Plaquettes avant			N° Schéma	Mâchoires avant G2165
				SEMI MÉTALLIQUES G1050	SEMI MÉTALLIQUES G1054	SINTERED G1380		
SENDA R 4T	125	4		507077	507212	507151	6	
SENDA SM 4T	125	4		507077	507212	507151	6	
GPR 125 NUDE	125	4		507077	507212	507151	6	
GPR 125 R	125	4	8	507077	507212	507151	6	
GP 1 125	125	6		507116	507252	507164	14	
GP 1 250	250	5	7	507116	507252	507164	14	
MULHACEN 650	650	6		507116	507252	507164	14	
BOULERVARD S	125	7		507120	507256	507166	7	
RAMBLA 125	125	7		507120	507256	507166	7	
RAMBLA 250 ie	250	8		507120	507256	507166	7	
RAMBLA 300 ie	300	10		507120	507256	507166	7	
GP 1 250 i	250	8		507124	507260		24	
SENDA DRD 125 R 4T 4V	125	9		507124	507260		24	
SENDA DRD 125 SM 4T 4V	125	9		507124	507260		24	
GPR 125 4T 4V	125	9		507124	507260		24	
GPR 125 R	125	9		507124	507260		24	
MULHACEN CAFÉ 125	125	8		507124	507260		24	
MULHACEN 125	125	6		507124	507260		24	
TERRA 4T 125	125	6		507124	507260		24	
TERRA 4T 125 ADVENTURE	125	8		507124	507260		24	
FREEXTER 125	125	6		507129	507266	507168	18	
CROSS CITY	125	9		507129	507266	507168	18	
250 RC	250	85						
BOULERVARD	125	3	6					
BOULERVARD	150	3						
BOULERVARD	200	5						
SONAR	125	10						
TT8 125	125	84						
DERBI 4 WHEELS								
DXR 200	200	4		507107	507246	507158	102	
DXR 250	250	4		507107	507246	507158	102	
DUCATI								
350 F3	350	86		507074	507202		2	
350 SPORT, GTV, SL, XL	350	77		507074	507202		2	
400 DESMO F3	400	87		507074	507202		2	
500 GTV	500	77		507074	507202		2	
500 PANTAH SL, TL	500	78		507074	507202		2	
600 PANTAH SL, TL	600	78		507074	507202		2	
650 DESMO	650	87		507074	507202		2	
750 F1 DESMO	750	86		507074	507202		2	
400 SS JUNIOR	400	91	92	507074	507202		2	
350 INDIANA	350	86		507074	507202		2	

				
Plaquettes arrière			Mâchoires arrière	
SEMI MÉTALLIQUES G1050	SEMI MÉTALLIQUES G1054	SINTERED G1380	N° Schéma	G2165
		507181	37	
		507181	37	
507137	507274		21	
507137	507274		21	
507116	507252	507164	14	
507116	507252	507164	14	
	507347		161	
507080	507215		88	
507080	507215		88	
507080	507215		88	
507080	507215		88	
507116	507252	507164	14	
507116	507252	507164	14	
507116	507252	507164	14	
507137	507274		21	
507137	507274		21	
507137	507274		21	
	507369		185	
	507369		185	
	507369		185	
507137	507274		21	
	507369		185	
507074	507202		2	
507129	507266	507168	18	
507129	507266	507168	18	
507129	507266	507168	18	
507111	507328	507160	5	
507074	507202		2	
507074	507202		2	
507074	507202		2	
507074	507202		2	
507074	507202		2	
507074	507202		2	
	507203		118	
	507203		118	
	507203		118	
	507209		188	

PLAQUETTES DE FREIN - MÂCHOIRES DE FREIN / BRAKE PADS - BRAKE SHOE

MOTEUR

CYCLE

PNEUMATIQUE

ATELIER

ACCESSOIRES

ÉLECTRICITÉ

FILTRATION

FREINAGE

TRANSMISSION

Modèle	Cylindre	Depuis	Jusqu'à	GALFER MOTO			GALFER MOTO	
				Plaquettes avant			Mâchoires avant	
				SEMI MÉTALLIQUES G1050	SEMI MÉTALLIQUES G1054	SINTERED G1380	N° Schéma	G2165
650 INDIANA	650	87		507074	507202		2	
750 INDIANA	750	88		507074	507202		2	
502	502	92		507074	507202		2	
350 SPORT	350	91		507074	507202		2	
400 SS	400	93		507074	507202		2	
600 SS	600	93		507074	507202		2	
600 SUPERMONO DESMO QUATTRO	600	93		507074	507202		2	
748 DESMO QUATTRO	748	94	97	507074	507202		2	
750 SS	750	91	97	507074	507202		2	
851 AA 8V STRADA	851	88	89	507074	507202		2	
851 REPLICA	851	88	88	507074	507202		2	
851 SPORT PRODUCTION	851	90	91	507074	507202		2	
851 STRADA	851	89		507074	507202		2	
888 CORSA	888	91	91	507074	507202		2	
888 DESMO QUATTRO	888	93	93	507074	507202		2	
888 SPS	888	92	92	507074	507202		2	
888 STRADA	888	94	95	507074	507202		2	
900 M MONSTER	900	93	99	507074	507202		2	
900 SC	900	88	89	507074	507202		2	
900 SS	900	91	97	507074	507202		2	
900 SUPERLIGHT	900	93		507074	507202		2	
907 i.e.	907	90	91	507074	507202		2	
907 i.e.	907	92		507074	507202		2	
916 SENNA	916	94	97	507074	507202		2	
916 SPS	916	98	98	507074	507202		2	
916 STRADA	916	94	98	507074	507202		2	
MONSTER 600	600	94	0	507074	507202		2	
MONSTER 750	750	96		507074	507202		2	
MONSTER 695	695	6		507074	507202		2	
MULTISTRADA MTS 620	620	5		507074	507202		2	
748	748	98	99	507074	507202		2	
998	998	2		507074	507202		2	
748 E/S	748	0	2	507074	507202		2	
900 M MONSTER	900	0	2	507074	507202		2	
996 S	996	99	1	507074	507202		2	
MH 900 E	900	0		507074	507202		2	
MONSTER 620 S i.e	620	1	4	507074	507202		2	
MONSTER 800 S i.e	800	3	4	507074	507202		2	
MONSTER S4	916	1	2	507074	507202		2	
MULTISTRADA MTS 620 DARK	620	5		507074	507202		2	
998 R	998	2		507074	507202		2	
998 S	998	2		507074	507202		2	

GALFER MOTO			GALFER MOTO	
Plaquettes arrière			Mâchoires arrière	
SEMI MÉTALLIQUES G1050	SEMI MÉTALLIQUES G1054	SINTERED G1380	N° Schéma	G2165
507078	507213		87	
507078	507213		87	
507078	507213		87	
507078	507213		87	
507078	507213		87	
507078	507213		87	
507078	507213		87	
507078	507213		87	
507078	507213		87	
507078	507213		87	
507078	507213		87	
507078	507213		87	
507078	507213		87	
507078	507213		87	
507078	507213		87	
507078	507213		87	
507078	507213		87	
507078	507213		87	
507078	507213		87	
507078	507213		87	
507078	507213		87	
507078	507213		87	
507078	507213		87	
507078	507213		87	
507078	507213		87	
507078	507213		87	
507078	507213		87	
507078	507213		87	
507078	507213		87	
507078	507213		87	
507143	507230	507154	48	
507143	507230	507154	48	
	507324		149	
	507324		149	
	507324		149	
	507324		149	
	507324		149	
	507324		149	
	507324		149	
	507324		149	
	507324		149	
	507324		149	
	507324		149	
	507324		149	
	507347		161	
	507347		161	

PLAQUETTES DE FREIN - MÂCHOIRES DE FREIN / BRAKE PADS - BRAKE SHOE

CGN
LE SENS DU DÉTAIL

MOTEUR

CYCLE

PNEUMATIQUE

ATELIER

ACCESSOIRES

ÉLECTRICITÉ

FILTRATION

FREINAGE

TRANSMISSION

Modèle	Cylindre	Depuis	Jusqu'à	GALFER MOTO			N° Schéma	Mâchoires avant G2165
				Plaquettes avant				
				SEMI MÉTALLIQUES G1050	SEMI MÉTALLIQUES G1054	SINTERED G1380		
1000 REPLICA	1000	84			507203		118	
350 PASO	350	86			507203		118	
500 SPORT	500	76			507203		118	
750 FI MONTJUICH	750	86			507203		118	
750 PASO	750	86			507203		118	
750 SANTA MONICA	750	88			507203		118	
750 SPORT	750	89	0		507203		118	
750 SS	750	76	90		507203		118	
900 SS, MHR	900	75			507203		118	
750 PASO	750	89			507203		118	
906 PASO	906	89			507203		118	
750 ENDURANCE	750	87			507203		118	
750 LAGUNA SECA	750	87			507203		118	
DESERT X	937	21		507092	507229		69	
MULTISTRADA 1200 PIKES PEAK	1200	15		507143	507230	507154	48	
MULTISTRADA 1200 S	1200	15		507143	507230	507154	48	
MULTISTRADA 1200 S D air	1200	15		507143	507230	507154	48	
MULTISTRADA 1260 D air	1260	18		507143	507230	507154	48	
MULTISTRADA 1260 PIKES PEAK	1260	18		507143	507230	507154	48	
MULTISTRADA 1260 S	1260	18		507143	507230	507154	48	
MULTISTRADA 1260 S GRAND TOUR	1260	20		507143	507230	507154	48	
MULTISTRADA V4	1150	22		507143	507230	507154	48	
MULTISTRADA V4 PIKES PEAK	1103	22		507143	507230	507154	48	
MULTISTRADA V4 S/SPORT	1103	21		507143	507230	507154	48	
MULTISTRADA 1200	1200	15		507143	507230	507154	48	
MULTISTRADA 1200 ENDURO	1200	15		507143	507230	507154	48	
MULTISTRADA 1260	1260	18		507143	507230	507154	48	
MULTISTRADA 1260 ENDURO	1260	19		507143	507230	507154	48	
MULTISTRADA 950	937	17		507143	507230	507154	48	
MULTISTRADA 950 S	937	19		507143	507230	507154	48	
MULTISTRADA V4	1103	21		507143	507230	507154	48	
GT 1000	1000	5			507320		145	
PAUL SMART 1000	1000	5			507320		145	
SIXTY 2	400	16			507320		145	
SPORT 1000	1000	5			507320		145	
SPORT 1000 S	1000	7			507320		145	
MONSTER 797	803	17			507320		145	
SCRAMBLER 1100	1100	18			507320		145	
SCRAMBLER 1100 SPECIAL	1100	18			507320		145	
SCRAMBLER 1100 SPORT	1100	18			507320		145	
SCRAMBLER 1100 SPORT PRO	1100	20			507320		145	
SCRAMBLER CAFÉ RACER	800	17			507320		145	

GALFER MOTO			GALFER MOTO	
Plaquettes arrière			Mâchoires arrière	
SEMI MÉTALLIQUES G1050	SEMI MÉTALLIQUES G1054	SINTERED G1380	N° Schéma	G2165
	507203		118	
	507203		118	
	507203		118	
	507203		118	
	507203		118	
	507203		118	
	507203		118	
	507203		118	
	507203		118	
	507209		188	
	507209		188	
507078	507213		87	
507078	507213		87	
	507199		83	
	507199		83	
	507199		83	
	507199		83	
	507199		83	
	507199		83	
	507199		83	
	507199		83	
	507322		147	
	507322		147	
	507322		147	
	507322		147	
	507322		147	
	507199		83	
	507199		83	
	507199		83	
	507199		83	
	507199		83	
	507199		83	

PLAQUETTES DE FREIN - MÂCHOIRES DE FREIN / BRAKE PADS - BRAKE SHOE

CGN
LE SENS DU DÉTAIL

MOTEUR

CYCLE

PNEUMATIQUE

ATELIER

ACCESSOIRES

ÉLECTRICITÉ

FILTRATION

FREINAGE

TRANSMISSION

Modèle	Cylindre	Depuis	Jusqu'à	GALFER MOTO			N° Schéma	Mâchoires avant G2165
				Plaquettes avant				
				SEMI MÉTALLIQUES G1050	SEMI MÉTALLIQUES G1054	SINTERED G1380		
SCRAMBLER CLASSIC	800	15			507320		145	
SCRAMBLER DESERT SLED	800	17			507320		145	
SCRAMBLER DESERT SLED FAST HOUSE	800	22			507320		145	
SCRAMBLER FLAT TRACK	800	16			507320		145	
SCRAMBLER FULL THROTTLE	800	15			507320		145	
SCRAMBLER HASHTAG	800	19			507320		145	
SCRAMBLER ICON	800	15			507320		145	
SCRAMBLER NIGHTSHIFT	800	21			507320		145	
SCRAMBLER URBAN ENDURO	800	15			507320		145	
DIAVEL 1200	1200	11			507322		147	
DIAVEL STRADA 1200	1200	13			507322		147	
DIAVEL V4	1150	22			507322		147	
DIAVEL X 1200	1200	16			507322		147	
DIAVEL X S 1200	1200	16			507322		147	
X DIAVEL 1260 S	1260	19			507322		147	
X DIAVEL 1260	1260	19			507322		147	
X DIAVEL 1260 DARK	1260	21			507322		147	
1098	1100	7	8	507116	507252	507164	14	
1198	1198	10		507116	507252	507164	14	
1098 S	1100	7	8	507116	507252	507164	14	
1198 R SP	1198	9		507116	507252	507164	14	
1198 S	1198	9		507116	507252	507164	14	
1199 PANIGALE	1199	12		507116	507252	507164	14	
1199 PANIGALE RS13	1199	13		507116	507252	507164	14	
1199 PANIGALE SUPERLEGGERA	1199	14		507116	507252	507164	14	
1299 PANIGALE	1299	15		507116	507252	507164	14	
1299 PANIGALE R	1299	15		507116	507252	507164	14	
1299 PANIGALE R FINAL EDITION	1299	17		507116	507252	507164	14	
1299 PANIGALE S	1299	15		507116	507252	507164	14	
1299 PANIGALE SUPERLEGGERA	1299	17		507116	507252	507164	14	
848 EVO	848	10		507116	507252	507164	14	
848 EVO CORSE SE	848	12		507116	507252	507164	14	
848 STREETFIGHTER EVO SP	848	12		507116	507252	507164	14	
DESMOSEDICI RR	989	7		507116	507252	507164	14	
HYPERMOTARD EVO SP	1100	10		507116	507252	507164	14	
HYPERMOTARD S	1100	7	9	507116	507252	507164	14	
MONSTER 1200 R	1200	16		507116	507252	507164	14	
MONSTER 1200 S	1200	14		507116	507252	507164	14	
MONSTER 1200 S BLACK	1200	20		507116	507252	507164	14	
MONSTER 937 SP	937	22		507116	507252	507164	14	
PANIGALE V4	1103	18		507116	507252	507164	14	

PLAQUETTES DE FREIN - MÂCHOIRES DE FREIN / BRAKE PADS - BRAKE SHOE

CGN
LE SENS DU DÉTAIL

MOTEUR

CYCLE

PNEUMATIQUE

ATELIER

ACCESSOIRES

ÉLECTRICITÉ

FILTRATION

FREINAGE

TRANSMISSION

Modèle	Cylindre	Depuis	Jusqu'à	Plaquettes avant			N° Schéma	Mâchoires avant G2165
				SEMI MÉTALLIQUES G1050	SEMI MÉTALLIQUES G1054	SINTERED G1380		
PANIGALE V4 25° ANNIVERSARIO 916	1103	20		507116	507252	507164	14	
PANIGALE V4 R	1000	19		507116	507252	507164	14	
PANIGALE V4 S	1103	18		507116	507252	507164	14	
PANIGALE V4 SP2	1103	19		507116	507252	507164	14	
PANIGALE V4 SPECIALE	1103	18		507116	507252	507164	14	
PANIGALE V4 SUPERLEGGERA	1103	20		507116	507252	507164	14	
STREETFIGHTER	1100	9		507116	507252	507164	14	
STREETFIGHTER S	1100	9		507116	507252	507164	14	
STREETFIGHTER V4	1100	21		507116	507252	507164	14	
STREETFIGHTER V4	1103	20		507116	507252	507164	14	
STREETFIGHTER V4 S	1100	21		507116	507252	507164	14	
STREETFIGHTER V4 S	1103	20		507116	507252	507164	14	
STREETFIGHTER V4 SP2	1100	22		507116	507252	507164	14	
ST 2 944	944	97	98	507116	507252	507164	14	
MONSTER 620 / DARK	620	5		507116	507252	507164	14	
MONSTER 800 S2R	800	5		507116	507252	507164	14	
848	848	8		507116	507252	507164	14	
400 MONSTER (JAPON)	400	4		507116	507252	507164	14	
620 SS	620	3		507116	507252	507164	14	
750 SPORT	750	1		507116	507252	507164	14	
750 SS	750	98		507116	507252	507164	14	
800 SPORT	800	3		507116	507252	507164	14	
800 SS	800	3		507116	507252	507164	14	
848 S	848	8		507116	507252	507164	14	
848 STREETFIGHTER	848	12		507116	507252	507164	14	
900 SS	900	98		507116	507252	507164	14	
HYPERMOTARD	796	10		507116	507252	507164	14	
HYPERMOTARD	1100	7	9	507116	507252	507164	14	
HYPERMOTARD EVO	1100	10		507116	507252	507164	14	
MONSTER	1100	9		507116	507252	507164	14	
MONSTER 1000 S i.e.	1000	3	5	507116	507252	507164	14	
MONSTER 1000 S2R	1000	6		507116	507252	507164	14	
MONSTER 696	695	8		507116	507252	507164	14	
MONSTER 796	796	10		507116	507252	507164	14	
MONSTER 796 ABS	796	10		507116	507252	507164	14	
MONSTER EVO	1100	11		507116	507252	507164	14	
MONSTER S	1100	9		507116	507252	507164	14	
MONSTER S (OHLINS)	1100	9		507116	507252	507164	14	
MONSTER S4R	996	3	5	507116	507252	507164	14	
MULTISTRADA 1000 DS	1000	3		507116	507252	507164	14	
MULTISTRADA 1100 DS	1100	7		507116	507252	507164	14	
MULTISTRADA 1100 S DS	1100	7		507116	507252	507164	14	

PLAQUETTES DE FREIN - MÂCHOIRES DE FREIN / BRAKE PADS - BRAKE SHOE

CGN
LE SENS DU DÉTAIL

MOTEUR

CYCLE

PNEUMATIQUE

ATELIER

ACCESSOIRES

ÉLECTRICITÉ

FILTRATION

FREINAGE

TRANSMISSION

Modèle	Cylindre	Depuis	Jusqu'à	GALFER MOTO			N° Schéma	Mâchoires avant G2165
				Plaquettes avant				
				SEMI MÉTALLIQUES G1050	SEMI MÉTALLIQUES G1054	SINTERED G1380		
MULTISTRADA 1200	1200	10	14	507116	507252	507164	14	
MULTISTRADA 1200 PIKES PEAK	1200	13	14	507116	507252	507164	14	
MULTISTRADA 1200 S GRAN TURISMO	1200	13	14	507116	507252	507164	14	
MULTISTRADA 1200 SS	1200	10	14	507116	507252	507164	14	
MULTISTRADA 1200 ST	1200	10	14	507116	507252	507164	14	
SS 1000 DS	1000	3		507116	507252	507164	14	
ST 3 / s ABS	992	6		507116	507252	507164	14	
ST 4	916	99		507116	507252	507164	14	
749	749	3		507116	507252	507164	14	
748 R	748	1	2	507116	507252	507164	14	
749 S/R	749	3		507116	507252	507164	14	
996 R	996	99	1	507116	507252	507164	14	
999 R	999	3		507116	507252	507164	14	
999 S	999	3		507116	507252	507164	14	
MONSTER S4Rs	998	6		507116	507252	507164	14	
MULTISTRADA 1000 S DS	1000	6		507116	507252	507164	14	
899 PANIGALE	899	13		507116	507252	507164	14	
959 PANIGALE	955	16	20	507116	507252	507164	14	
959 PANIGALE CORSE	955	18	20	507116	507252	507164	14	
HYPERMOTARD	821	13		507116	507252	507164	14	
HYPERMOTARD 939	937	16		507116	507252	507164	14	
HYPERMOTARD 950	937	19		507116	507252	507164	14	
HYPERMOTARD 950 RVE	937	21		507116	507252	507164	14	
HYPERMOTARD 950 S	937	19		507116	507252	507164	14	
HYPERMOTARD 950 SP	937	19		507116	507252	507164	14	
HYPERMOTARD SP	821	13		507116	507252	507164	14	
HYPERMOTARD SP 939	937	16		507116	507252	507164	14	
HYPERSTRADA	821	13		507116	507252	507164	14	
HYPERSTRADA 939	937	16		507116	507252	507164	14	
MONSTER 1200	1200	14		507116	507252	507164	14	
MONSTER 821	821	14		507116	507252	507164	14	
MONSTER 821 STEALTH	821	19		507116	507252	507164	14	
MONSTER 937	937	21		507116	507252	507164	14	
PANIGALE V2	955	21		507116	507252	507164	14	
STREETFIGHTER V2	955	22		507116	507252	507164	14	
SUPERSPORT 950	937	17		507116	507252	507164	14	
SUPERSPORT 950 S	937	17		507116	507252	507164	14	
250, 350 DESMO	250	75						
500 GTL, SPORT DESMO	500	76						
750 GT	750	76						
860 GT, GTS	860	75						
900 GTS	900	76						

PLAQUETTES DE FREIN - MÂCHOIRES DE FREIN / BRAKE PADS - BRAKE SHOE

MOTEUR

CYCLE

PNEUMATIQUE

ATELIER

ACCESSOIRES



ÉLECTRICITÉ

FILTRATION

FREINAGE

TRANSMISSION

Modèle	Cylindre	Depuis	Jusqu'à	GALFER MOTO			N° Schéma	Mâchoires avant G2165
				Plaquettes avant				
				SEMI MÉTALLIQUES G1050	SEMI MÉTALLIQUES G1054	SINTERED G1380		
900 SPORT	900	75						
E-TON 4 WHEELS								
VECTOR ST 250 / 250	250	6		507088	507225		31	
VIPER ST EXL 150	150	5		507088	507225		31	
CHALLENGE CLX 150	150	3		507088	507225		31	
VIPER 150 / RLX 150	150	5		507088	507225		31	
YUKON ST ELX 150	150	3		507088	507225		31	
VECTOR ST 300	300	7		507145	507282	507187	111	
VORTEX ST 300	300	7		507145	507282	507187	111	
ENERGICA								
EGO	EL	18		507116	507252	507164	14	
EGO 45	EL	18		507116	507252	507164	14	
EGO SPORT BLACK	EL	19		507116	507252	507164	14	
ESSEESSE9	EL	18		507116	507252	507164	14	
EVA	EL	18		507116	507252	507164	14	
EVA RIBELLE	EL	20		507116	507252	507164	14	
EVA RIBELLE RS	EL	21		507116	507252	507164	14	
EXPERIA	EL	22		507116	507252	507164	14	
FACTORY								
YR 125 CB	125	4		507081	507216		23	
YR 250	250	98			507320		145	
FACTORY 4 WHEELS								
TORNADO 150	150	2		507081	507216		23	
FANTIC								
CABALLERO RC 125	125	94	96	507075	507210		4	
125 K-ROO	125	92		507077	507212	507151	6	
125.5 TRIAL	125	89	89	507077	507212	507151	6	
125.7 TRIAL	125	90		507077	507212	507151	6	
125.9 TRIAL	125	90		507077	507212	507151	6	
247 TRIAL	247	90		507077	507212	507151	6	
249 SECTION	250	95		507077	507212	507151	6	
250 COACH	250	95		507077	507212	507151	6	
305 TRIAL	305	89	89	507077	507212	507151	6	
307 TRIAL	307	90	90	507077	507212	507151	6	
309 TRIAL	309	91		507077	507212	507151	6	
125.3 PROFESIONAL (FM 361)	125	87	88		507294		119	
243 TRIAL (FM 363)	243	87			507294		119	
303 TRIAL (FM 364)	303	87	88		507294		119	
REGOLARITA CASA	125	7		507081	507216		23	
SUPERSEI MOTARD	125	7		507081	507216		23	
REGOLARITA COMPETICION	125	7			507300		125	
X RIDER 125	125	7			507300		125	

 Plaquettes arrière			 Mâchoires arrière	
SEMI MÉTALLIQUES G1050	SEMI MÉTALLIQUES G1054	SINTERED G1380	N° Schéma	G2165
	507203		118	
507085	507222	507152	25	
507085	507222	507152	25	
			2	507373
			2	507373
			2	507373
507085	507222	507152	25	
507085	507222	507152	25	
		507181	37	
507143	507230	507154	48	
507080	507215		88	
507077	507212	507151	6	
507077	507212	507151	6	
507077	507212	507151	6	
507077	507212	507151	6	
507077	507212	507151	6	
507077	507212	507151	6	
507077	507212	507151	6	
507077	507212	507151	6	
507077	507212	507151	6	
507077	507212	507151	6	
	507294		119	
	507294		119	
	507294		119	
		507181	37	
		507181	37	
	507319		144	
	507319		144	

PLAQUETTES DE FREIN - MÂCHOIRES DE FREIN / BRAKE PADS - BRAKE SHOE

MOTEUR

CYCLE

PNEUMATIQUE

ATELIER

ACCESSOIRES



ÉLECTRICITÉ

FILTRATION

FREINAGE

TRANSMISSION

Modèle	Cylindre	Depuis	Jusqu'à	GALFER MOTO			N° Schéma	Mâchoires avant G2165
				Plaquettes avant				
				SEMI MÉTALLIQUES G1050	SEMI MÉTALLIQUES G1054	SINTERED G1380		
XEF COMPETITION 125 2T	125	21			507300		125	
XMF COMPETITION 125 2T	125	21			507300		125	
CABALLERO	125	97		507091	507228		22	
CABALLERO DELUXE	500	22			507320		145	
CABALLERO EXPLORER	500	22			507320		145	
CABALLERO FLAT TRACK	125	18			507320		145	
CABALLERO FLAT TRACK	250	18			507320		145	
CABALLERO FLAT TRACK	500	18			507320		145	
CABALLERO RALLY	125	22			507320		145	
CABALLERO RALLY	500	22			507320		145	
CABALLERO SCRAMBLER	125	18			507320		145	
CABALLERO SCRAMBLER	250	18			507320		145	
CABALLERO SCRAMBLER	500	18			507320		145	
CABALLERO SIX DAYS	500	22			507320		145	
CABALLERO MOTARD 4T	125	10			507355		167	
CABALLERO MOTARD 4T	200	10			507355		167	
CABALLERO REGOLARITA 4T	125	10			507355		167	
CABALLERO REGOLARITA 4T	200	10			507355		167	
ENDURO 4T	250	16	17		507355		167	
XE 125 2T	125	21			507356		168	
XEF 250 4T	250	21			507356		168	
XEF 450	450	21			507356		168	
XX 125 2T	125	20			507356		168	
XX 250	250	21			507356		168	
XXF 250	250	21			507356		168	
XXF 450	450	21			507356		168	
450 RALLY	450	22			507356		168	
XE 250 2T	250	20			507356		168	
125 RAIDER	125	83						
125 SPORT HP1	125	86						
125 STRADA	125	83						
125 STRADA MKII	125	83						
125.1 TRIAL	125	86	86					
125.2 TRIAL	125	87	88					
201-1 TRIAL	201	86						
243-2 TRIAL	243	87						
249 TRIAL COACH	249	89	94					
250 COACH	250	92	93					
250 RAIDER (FM 259)	250	85						
301-1 TRIAL	301	86	86					
303-2 TRIAL	303	87	88					

 Plaquettes arrière			 Mâchoires arrière	
SEMI MÉTALLIQUES G1050	SEMI MÉTALLIQUES G1054	SINTERED G1380	N° Schéma	G2165
	507319		144	
	507319		144	
	507370		186	
	507370		186	
	507370		186	
	507370		186	
	507370		186	
	507370		186	
	507370		186	
	507370		186	
	507370		186	
	507370		186	
	507370		186	
	507370		186	
	507370		186	
	507367		183	
	507367		183	
507075	507210		4	
507075	507210		4	
507075	507210		4	
	507294		119	
	507294		119	
	507294		119	
	507294		119	
507077	507212	507151	6	
507077	507212	507151	6	
507080	507215		88	
	507294		119	
	507294		119	

Modèle	Cylindre	Depuis	Jusqu'à	GALFER MOTO Plaquettes avant			N° Schéma	Mâchoires avant G2165
				SEMI MÉTALLIQUES G1050	SEMI MÉTALLIQUES G1054	SINTERED G1380		
FB MONDIAL								
HPS 125	125	22		507081	507216		23	
PIEGA HIPER NAKED	125	22		507081	507216		23	
SMX 125	125	22		507086	507223		9	
SPARTAN	125	22		507086	507223		9	
GARELLI								
125 GTA (3 FD)	125	87		507074	507202		2	
125 TIGER XLE	125	87		507075	507210		4	
125 TRIAL SECTION	125	95		507077	507212	507151	6	
249 TRIAL SECTION	249	95		507077	507212	507151	6	
125 GTA	125	86	86					
125 GTA	125	87						
125 HAWR	125	86						
125 TIGER XR, XRD	125	86	86					
200 HAWR	200	86						
323 TRIAL	323	86						
GAS GAS								
125 PAMPERA	125	96	98	507077	507212	507151	6	
125 PAMPERA 4T	125	99	2	507077	507212	507151	6	
200 PAMPERA	200	99		507077	507212	507151	6	
250 PAMPERA	250	96	2	507077	507212	507151	6	
320 PAMPERA	320	99		507077	507212	507151	6	
CONTAC JT 250	250	94		507077	507212	507151	6	
CONTAC T25	250	93	93	507077	507212	507151	6	
JT 12 125	125	95		507077	507212	507151	6	
JT 16 150	150	95		507077	507212	507151	6	
JT 160	160	95		507077	507212	507151	6	
JT 25	250	91		507077	507212	507151	6	
JT 32	320	91		507077	507212	507151	6	
JT 350	350	95		507077	507212	507151	6	
JTR 140 CONTACT	140	96		507077	507212	507151	6	
JTR 250 CONTACT	250	96		507077	507212	507151	6	
JTR 270 CONTACT	270	96	97	507077	507212	507151	6	
JTR 370 CONTACT	370	96		507077	507212	507151	6	
TRIAL 327	327	89		507077	507212	507151	6	
TXT 270	270	98	98	507077	507212	507151	6	
HALLEY 325 PCX	325	87			507294		119	
EC 125	125	94	0	507080	507215		88	
MC 125	125	94	0	507080	507215		88	
EC 250	250	95	98	507081	507216		23	
ENDURO TT 125	125	93		507081	507216		23	
MC 250	250	95	98	507081	507216		23	

GALFER MOTO			GALFER MOTO	
Plaquettes arrière			Mâchoires arrière	
SEMI MÉTALLIQUES G1050	SEMI MÉTALLIQUES G1054	SINTERED G1380	N° Schéma	G2165
	507368		184	
	507368		184	
	507221		33	
		519664	193	
507080	507215		88	
507080	507215		88	
507077	507212	507151	6	
507077	507212	507151	6	
507074	507202		2	
507080	507215		88	
507080	507215		88	
507074	507202		2	
507080	507215		88	
507077	507212	507151	6	
507077	507212	507151	6	
507077	507212	507151	6	
507077	507212	507151	6	
507077	507212	507151	6	
507077	507212	507151	6	
507077	507212	507151	6	
507077	507212	507151	6	
507077	507212	507151	6	
507077	507212	507151	6	
507077	507212	507151	6	
507077	507212	507151	6	
507077	507212	507151	6	
507077	507212	507151	6	
507077	507212	507151	6	
507077	507212	507151	6	
507077	507212	507151	6	
507077	507212	507151	6	
507077	507212	507151	6	
	507294		119	
507143	507230	507154	48	
507143	507230	507154	48	
507143	507230	507154	48	
507143	507230	507154	48	
507143	507230	507154	48	

MOTEUR

CYCLE

PNEUMATIQUE

ATELIER

ACCESSOIRES

ÉLECTRICITÉ

FILTRATION

FREINAGE

TRANSMISSION

PLAQUETTES DE FREIN - MÂCHOIRES DE FREIN / BRAKE PADS - BRAKE SHOE

MOTEUR

CYCLE

PNEUMATIQUE

ATELIER

ACCESSOIRES

ÉLECTRICITÉ

FILTRATION

FREINAGE



TRANSMISSION

Modèle	Cylindre	Depuis	Jusqu'à	GALFER MOTO			GALFER MOTO	
				Plaquettes avant			Mâchoires avant	
				SEMI MÉTALLIQUES G1050	SEMI MÉTALLIQUES G1054	SINTERED G1380	N° Schéma	G2165
FSR 450	450	7			507300		125	
HALLEY 125 SM	125	9			507300		125	
SM 125	125	5			507300		125	
SM 450	450	5			507300		125	
SM 125	125	1	4		507300		125	
SM 250	250	1			507300		125	
SM 400	400	1			507300		125	
ENDUCAMP 125 4T	125	5			507300		125	
ENDUCAMP 400 4T	400	5			507300		125	
EC 125	125	1	14		507300		125	
EC 200	200	1			507300		125	
EC 250	250	1	20		507300		125	
EC 250 FSE	250	1			507300		125	
EC 250 RACING	250	9			507300		125	
EC 300	300	1	20		507300		125	
EC 400 FSE	400	1			507300		125	
EC 450 FSE	450	3			507300		125	
HALLEY 125	125	9			507300		125	
MC 125	125	1	20		507300		125	
MC 250	250	1	15		507300		125	
PAMPERA 400	400	6			507300		125	
HALLEY 450 SM	450	9			507300		125	
EC 200	200	99	0		507320		145	
EC 250	250	99	0		507320		145	
EC 300	300	99	0		507320		145	
EC 400 FSE	400	99	0		507320		145	
FSE 250 4T	250	99			507320		145	
MC 250	250	99	0		507320		145	
TT 125	125	95			507320		145	
TT 250	250	95			507320		145	
ES 700	700	22			507320		145	
RX 450 F REPLICIA	450	22			507320		145	
SM 700	700	22			507320		145	
TRIAL GP 125	125	19		507118	507254		106	
TRIAL GP 250	250	19		507118	507254		106	
TRIAL GP 280	280	19		507118	507254		106	
TRIAL GP 300	300	19		507118	507254		106	
TXT PRO RACING 125	125	12	13	507118	507254		106	
TXT PRO RACING 125	125	14	18	507118	507254		106	
TXT PRO RACING 125	125	19		507118	507254		106	
TXT PRO RACING 250	250	12	13	507118	507254		106	
TXT PRO RACING 250	250	14	18	507118	507254		106	

GALFER MOTO			GALFER MOTO	
Plaquettes arrière			Mâchoires arrière	
SEMI MÉTALLIQUES G1050	SEMI MÉTALLIQUES G1054	SINTERED G1380	N° Schéma	G2165
507078	507213		87	
507078	507213		87	
507078	507213		87	
507078	507213		87	
	507307		132	
	507307		132	
	507307		132	
		507181	37	
		507181	37	
	507319		144	
	507319		144	
	507319		144	
	507319		144	
	507319		144	
	507319		144	
	507319		144	
	507319		144	
	507319		144	
	507319		144	
	507319		144	
	507319		144	
	507319		144	
	507319		144	
	507319		144	
	507369		185	
507143	507230	507154	48	
507143	507230	507154	48	
507143	507230	507154	48	
507143	507230	507154	48	
507143	507230	507154	48	
507143	507230	507154	48	
507143	507230	507154	48	
507143	507230	507154	48	
	507322		147	
	507322		147	
	507199		83	

PLAQUETTES DE FREIN - MÂCHOIRES DE FREIN / BRAKE PADS - BRAKE SHOE

Modèle	Cylindre	Depuis	Jusqu'à	GALFER MOTO Plaquettes avant			N° Schéma	Mâchoires avant G2165
				SEMI MÉTALLIQUES G1050	SEMI MÉTALLIQUES G1054	SINTERED G1380		
TXT PRO RACING 250	250	19		507118	507254		106	
TXT PRO RACING 280	280	12	13	507118	507254		106	
TXT PRO RACING 280	280	14	18	507118	507254		106	
TXT PRO RACING 280	280	19		507118	507254		106	
TXT PRO RACING 300	300	14	18	507118	507254		106	
TXT PRO RACING 300	300	19		507118	507254		106	
TXT 125	125	4		507118	507254		106	
TXT 250	250	3	3	507118	507254		106	
TXT 250	250	4		507118	507254		106	
TXT 280	280	3	3	507118	507254		106	
TXT 280	280	4		507118	507254		106	
TXT 300	300	4		507118	507254		106	
125 PAMPERA	125	3		507119	507255		107	
250 PAMPERA	250	3		507119	507255		107	
TXT 125	125	99	3	507119	507255		107	
TXT 200	200	99		507119	507255		107	
TXT 250	250	99	2	507119	507255		107	
TXT 270	270	99	1	507119	507255		107	
TXT 280	280	0	2	507119	507255		107	
TXT 321	321	99		507119	507255		107	
HALLEY 450	450	9		507124	507260		24	
EC 125	125	15			507356		168	
EC 125 SIX DAYS	125	11			507356		168	
EC 200 SIX DAYS	200	11			507356		168	
EC 250 E	250	11			507356		168	
EC 250 F	250	10			507356		168	
EC 250 SIX DAYS	250	11			507356		168	
EC 250 YR	250	12			507356		168	
EC 300 E	300	11			507356		168	
EC 300 F	300	15			507356		168	
EC 300 RACING	300	9			507356		168	
EC 300 SIX DAYS	300	11			507356		168	
EC 450 F	450	15			507356		168	
EC 450 RAID	450	15			507356		168	
TRIAL 125 4T	125	11						
GAS GAS 4 WHEELS								
KS 250 RV DER.	250	6						
HP WILD 240	240	3		507143	507230	507154	48	
HP WILD 300	300	3		507143	507230	507154	48	
HP WILD 450	450	3		507143	507230	507154	48	
HP WILD 515	515	9		507143	507230	507154	48	
KS 250 RV IZQ.	250	6						

 Plaquettes arrière			 Mâchoires arrière	
SEMI MÉTALLIQUES G1050	SEMI MÉTALLIQUES G1054	SINTERED G1380	N° Schéma	G2165
	507343		157	
	507343		157	
	507343		157	
	507343		157	
	507343		157	
	507343		157	
		507181	37	
		507181	37	
507119	507255		107	
507119	507255		107	
507119	507255		107	
507119	507255		107	
507119	507255		107	
507119	507255		107	
	507369		185	
	507319		144	
	507319		144	
	507319		144	
	507319		144	
	507319		144	
	507319		144	
	507319		144	
	507319		144	
	507319		144	
	507319		144	
	507319		144	
	507319		144	
	507319		144	
	507319		144	
	507343		157	
507088	507225		31	
507143	507230	507154	48	
507143	507230	507154	48	
507143	507230	507154	48	
507143	507230	507154	48	
	507221		33	

PLAQUETTES DE FREIN - MÂCHOIRES DE FREIN / BRAKE PADS - BRAKE SHOE

CGN
LE SENS DU DÉTAIL

MOTEUR

CYCLE

PNEUMATIQUE

ATELIER

ACCESSOIRES

ÉLECTRICITÉ

FILTRATION

FREINAGE

TRANSMISSION

Modèle	Cylindre	Depuis	Jusqu'à	GALFER MOTO Plaquettes avant			N° Schéma	Mâchoires avant G2165
				SEMI MÉTALLIQUES G1050	SEMI MÉTALLIQUES G1054	SINTERED G1380		
GAS GAS A								
TXT RACING 125	125	23		507118	507254		106	
TXT RACING 250	250	23		507118	507254		106	
TXT RACING 280	280	23		507118	507254		106	
TXT RACING 300	300	23		507118	507254		106	
MC E5	EL	21			507344		158	
EC 250	250	21			507358		170	
EC 250 F	250	21			507358		170	
EC 300	300	21			507358		170	
EC 350 F	350	21			507358		170	
MC 125	125	21			507358		170	
MC 250	250	21			507358		170	
MC 250 F	250	21			507358		170	
MC 350 F	350	21			507358		170	
MC 450 F	450	21			507358		170	
GENERIC								
TRIGER 125 SM	125	8		507075	507210		4	
TTX	EL	16		507079	507214		38	
VIONIS	EL	18		507079	507214		38	
ZION 150	150	11		507107	507246	507158	102	
GRS 600	600	13		507116	507252	507164	14	
CODE S	125	12		507120	507256	507166	7	
CODE S	150	12		507120	507256	507166	7	
CODE S	200	12		507120	507256	507166	7	
CODE X	125	12		507120	507256	507166	7	
CODE X	150	12		507120	507256	507166	7	
CODE X	200	12		507120	507256	507166	7	
WORX	150	12		507120	507256	507166	7	
TR 125 SM	125	17		507120	507256	507166	7	
TW 125 SM	125	17		507120	507256	507166	7	
EPICO ELECTRIC	EL	12						
IDEO 125	125	5					13	507384
SOHO 125	125	6						
XOR 125	125	5					13	507384
ZION 125	125	8						
ZION 150	150	8	10					
GILERA-PIAGGIO								
250 RALLY	250	86		507074	507202		2	
250 NGR	250	87		507074	507202		2	
491 SATURNO	500	89		507074	507202		2	
125 CCM APTS	125	87		507074	507202		2	
125 FAST BIKE	125	87		507074	507202		2	

GALFER MOTO			GALFER MOTO	
Plaquettes arrière			Mâchoires arrière	
SEMI MÉTALLIQUES G1050	SEMI MÉTALLIQUES G1054	SINTERED G1380	N° Schéma	G2165
	507344		158	
507143	507230	507154	48	
507143	507230	507154	48	
507143	507230	507154	48	
507143	507230	507154	48	
507143	507230	507154	48	
507143	507230	507154	48	
507143	507230	507154	48	
507143	507230	507154	48	
507143	507230	507154	48	
507143	507230	507154	48	
		507181	37	
507079	507214		38	
507079	507214		38	
507107	507246	507158	102	
	507347		161	
	507234	507180	90	
507107	507246	507158	102	
507128	507167		44	
507083	507244		19	
507083	507244		19	
507083	507244		19	
507083	507244		19	
507107	507246	507158	102	
507107	507246	507158	102	
507074	507202		2	
507075	507210		4	
507078	507213		87	
507080	507215		88	
507080	507215		88	

MOTEUR

CYCLE

PNEUMATIQUE

ATELIER

ACCESSOIRES

ÉLECTRICITÉ

FILTRATION

FREINAGE

TRANSMISSION

PLAQUETTES DE FREIN - MÂCHOIRES DE FREIN / BRAKE PADS - BRAKE SHOE

CGN
LE SENS DU DÉTAIL

MOTEUR

CYCLE

PNEUMATIQUE

ATELIER

ACCESSOIRES

ÉLECTRICITÉ

FILTRATION

FREINAGE



TRANSMISSION

Modèle	Cylindre	Depuis	Jusqu'à	GALFER MOTO			N° Schéma	Mâchoires avant G2165
				Plaquettes avant				
				SEMI MÉTALLIQUES G1050	SEMI MÉTALLIQUES G1054	SINTERED G1380		
125 KZ	125	86		507074	507202		2	
125 KZ ENDURANCE	125	88		507074	507202		2	
125 R1	125	88		507074	507202		2	
125 TX1	125	88		507074	507202		2	
125 XRI	125	88	88	507074	507202		2	
200 FAST BIKE	200	87		507074	507202		2	
200 RTX	200	86		507074	507202		2	
200 RV A/E	200	87		507074	507202		2	
200 RV ES	200	87		507074	507202		2	
350 XRT	350	89		507074	507202		2	
600 RC	600	88	88	507074	507202		2	
600 XRT	600	88	89	507074	507202		2	
125 MX1	125	88		507074	507202		2	
125 MXR	125	89		507074	507202		2	
125 SP01	125	89	89	507074	507202		2	
125 RC	125	90		507074	507202		2	
125 XR2	125	89		507074	507202		2	
600 XRT	600	90		507074	507202		2	
125 CRONO AE	125	91		507074	507202		2	
125 CX, AE	125	91		507074	507202		2	
125 FREESTYLE	125	92		507074	507202		2	
125 GFR	125	93	94	507074	507202		2	
125 SP02	125	90		507074	507202		2	
600 NORTHWEST	600	91		507074	507202		2	
350 NORTHWEST	491	94		507074	507202		2	
125 X1	125	89		507075	507210		4	
125 SATURNO PIUMA	125	90		507077	507212	507151	6	
500 SATURNO PIUMA	500	90		507077	507212	507151	6	
SC 125	125	6		507077	507212	507151	6	
125 APACHE	125	92		507082	507218		70	
125 RC TOP RALLY	125	89	89	507082	507218		70	
600 RC	600	89	90	507082	507218		70	
600 RC FOUR VALVE	600	91		507082	507218		70	
RC 600 R	600	92	93	507082	507218		70	
GP 850 CORSA	850	9			507320		145	
RC 600 R, COBRA	600	94						
RUNNER 125 SP	125	99	0	507111	507328	507160	5	
RUNNER 180 SP	180	99	0	507111	507328	507160	5	
NEXUS	500	3	5	507116	507252	507164	14	
NEXUS i.e.	250	6	6	507116	507252	507164	14	
NEXUS i.e. SP	500	6		507116	507252	507164	14	
600 SUPERSPORT	600	2		507116	507252	507164	14	

GALFER MOTO			GALFER MOTO	
Plaquettes arrière			Mâchoires arrière	
SEMI MÉTALLIQUES G1050	SEMI MÉTALLIQUES G1054	SINTERED G1380	N° Schéma	G2165
507080	507215		88	
507080	507215		88	
507080	507215		88	
507080	507215		88	
507080	507215		88	
507080	507215		88	
507080	507215		88	
507080	507215		88	
507080	507215		88	
507080	507215		88	
507080	507215		88	
507080	507215		88	
507084	507220		91	
507084	507220		91	
507084	507220		91	
	507298		123	
	507298		123	
	507298		123	
507089	507226		93	
507089	507226		93	
507089	507226		93	
507089	507226		93	
507089	507226		93	
	507311		136	
507080	507215		88	
507078	507213		87	
507078	507213		87	
507137	507274		21	
	507298		123	
	507298		123	
	507298		123	
	507298		123	
	507298		123	
	507347		161	
507089	507226		93	
		507181	37	
		507181	37	
507143	507230	507154	48	
507143	507230	507154	48	
507143	507230	507154	48	
	507347		161	

PLAQUETTES DE FREIN - MÂCHOIRES DE FREIN / BRAKE PADS - BRAKE SHOE



Modèle	Cylindre	Depuis	Jusqu'à	GALFER MOTO Plaquettes avant			N° Schéma	Mâchoires avant G2165
				SEMI MÉTALLIQUES G1050	SEMI MÉTALLIQUES G1054	SINTERED G1380		
DNA 125 (G)	125	1		507127	507265		17	
DNA 180 (G)	180	1		507127	507265		17	
MAD-MUD (G)	180	2		507127	507265		17	
RUNNER 125 VX (G)	125	1		507127	507265		17	
RUNNER 180 VXR (G)	180	1		507127	507265		17	
RUNNER 200 VXR	200	2	5	507127	507265		17	
DNA 125 (H)	125	1		507127	507265		17	
DNA 180 (H)	180	1		507127	507265		17	
MAD-MUD (H)	180	2		507127	507265		17	
NEXUS i.e.	250	7		507127	507265		17	
RUNNER 125 VX (H)	125	1		507127	507265		17	
RUNNER 180 VXR (H)	180	1		507127	507265		17	
RUNNER 200 VXR	200	6		507127	507265		17	
GP 800	800	8		507131	507268	507170	35	
NEXUS	125	7		507131	507268	507170	35	
NEXUS i.e.	125	9		507131	507268	507170	35	
NEXUS i.e.	300	9		507131	507268	507170	35	
FUOCO 500 i.e.	500	7						
125 A/E ARIZONA RZE	125	87						
125 ER	125	87						
125 HX,LC	125	83						
125 RC RALLY	125	88	88					
125 RRT NEBRASKA	125	87						
125 RTX	125	86						
125 RV	125	83	86					
125 RV ES	125	87						
125 RVE A/E	125	87						
125 RX, ARIZONA	125	83						
125 TYPHOON	125	95					17	507388
200 ARIZONA	200	83						
200 ER	200	87						
200 RX	200	83						
250 AR ARIZONA RALLY	250	86						
250 HX LC	250	83						
250 NE	250	83						
250 NX	250	83						
250 RAIDER	250	86						
323 TRIAL	350	86						
350 DAKOTA 4T	350	86	86					
350 ER	350	87	88					
500 DAKOTA	500	87						
500 ER	500	87						

				
Plaquettes arrière			Mâchoires arrière	
SEMI MÉTALLIQUES G1050	SEMI MÉTALLIQUES G1054	SINTERED G1380	N° Schéma	G2165
		507181	37	
		507181	37	
		507181	37	
		507181	37	
		507181	37	
		507181	37	
507131	507268	507170	35	
507131	507268	507170	35	
507131	507268	507170	35	
507131	507268	507170	35	
507131	507268	507170	35	
507131	507268	507170	35	
507131	507268	507170	35	
507131	507268	507170	35	
507143	507230	507154	48	
507131	507268	507170	35	
507131	507268	507170	35	
507131	507268	507170	35	
507111	507328	507160	5	
507080	507215		88	
507080	507215		88	
507074	507202		2	
507080	507215		88	
507080	507215		88	
507080	507215		88	
507074	507202		2	
507080	507215		88	
507080	507215		88	
507074	507202		2	
507102	507239	507156	3	
507074	507202		2	
507080	507215		88	
507074	507202		2	
507074	507202		2	
507074	507202		2	
507074	507202		2	
507074	507202		2	
507080	507215		88	
507077	507212	507151	6	
507080	507215		88	
507080	507215		88	
507080	507215		88	
507080	507215		88	

PLAQUETTES DE FREIN - MÂCHOIRES DE FREIN / BRAKE PADS - BRAKE SHOE

CGN
LE SENS DU DÉTAIL

Modèle	Cylindre	Depuis	Jusqu'à	GALFER MOTO Plaquettes avant			GALFER MOTO Mâchoires avant	
				SEMI MÉTALLIQUES G1050	SEMI MÉTALLIQUES G1054	SINTERED G1380	N° Schéma	G2165
COUGAR 125	125	1						
RUNNER 125 FX (G)	125	97	98					
RUNNER 125 FX (H)	125	97	98					
RUNNER 180 FXR (G)	180	98	98					
RUNNER 180 FXR (H)	180	98	98					
GOES 4 WHEELS								
360 MAX	360							
G 125 X	125			507079	507214		38	
350 S	350			507081	507216		23	
G 125 XM	125				507300		125	
G 250 XM	125				507300		125	
GS 125 BIG WHEEL	125	8			507234	507180	90	
GOVECS								
GO ! S1.2	EL	10						
GRIMECA								
RADIAL SCOOTER		4						
H.R.D.								
125 FORMULA LS	125	86		507075	507210		4	
125 PLATINO SL	125	86		507075	507210		4	
125 SILVER-HOUSE	125	86		507075	507210		4	
125 SILVER-HOUSE RS	125	86		507075	507210		4	
125 PLATINO ST	125	86						
125 ROAD ST	125	86						
HARLEY DAVIDSON								
RH 1250 SPORSTER S	1250	22						
XG 500 STREET	500	16		507143	507230	507154	48	
XG 750 STREET	750	16		507143	507230	507154	48	
PAN AMERICA	1250	21			507320		145	
LIVE WIRE	EL			507116	507252	507164	14	
XL 1200 V SEVENTY-TWO	1200	14			507349		163	
XL 1200 X FORTY EIGHT	1200	14			507349		163	
XL IRON	883	14			507349		163	
XL ROADSTER	1200	14			507349		163	
XL SPORTSTER CUSTOM	1200	14			507349		163	
XL T LOW	1200	14			507349		163	
XR 1200	1200	8	10					
XR 1200 R	1200	10						
XR 1200 STORZ	1200	10						
XR 1200 X	1200	10						
CVO PRO STREET BREAKOUT	1801	14						
CVO SOFTAIL DELUXE	1801	15						
FLS SOFTAIL SLIM	1584	15						

				
Plaquettes arrière			Mâchoires arrière	
SEMI MÉTALLIQUES G1050	SEMI MÉTALLIQUES G1054	SINTERED G1380	N° Schéma	G2165
507080	507215		88	
		507181	37	
507131	507268	507170	35	
		507181	37	
507131	507268	507170	35	
507079	507214		38	
507085	507222	507152	25	
	507319		144	
	507319		144	
507079	507214		38	
507077	507212	507151	6	
507075	507210		4	
507075	507210		4	
507075	507210		4	
507075	507210		4	
507074	507202		2	
507074	507202		2	
	507199		83	
	507322		147	
	507322		147	
	507199		83	
	507199		83	
	507335		156	
	507335		156	
	507335		156	
	507335		156	
	507335		156	
	507335		156	
	507335		156	

Modèle	Cylindre	Depuis	Jusqu'à	GALFER MOTO			GALFER MOTO	
				Plaquettes avant			Mâchoires avant	
				SEMI MÉTALLIQUES G1050	SEMI MÉTALLIQUES G1054	SINTERED G1380	N° Schéma	G2165
FLSTC HERITAGE CLASSIC SOFTAIL	1450	15						
FLSTF FAT BOY	1450	16						
FLSTF FAT BOY	1690	15						
FLSTFB FAT BOY	1690	15						
FLSTN SOFTAIL DELUXE	1690	15						
FXSB BREAKOUT	1690	15						
FXST/i SOFTAIL STANDARD	1450	15						
FLDE DELUXE	1745	18						
FLFB FAT BOY 104	1745	18						
FLFB FAT BOY 114	1868	18						
FLHC HERITAGE CLASSIC 107	1745	18						
FLHC HERITAGE CLASSIC 114	1868	18						
FLS SOFTAIL SLIM	1745	18						
FXBB STREET BOB	1745	18						
FXBR BREAKOUT 107	1745	18						
FXBRS BREAKOUT 114	1868	18						
FXFBS FAT BOB 107	1745	18						
FXFBS FAT BOB 114	1868	18						
FXLR LOW RIDER	1745	18						
FXST SOFTAIL ESTANDAR	1745	19						
SPORT GLIDE	1868	18						
FLSB SPORT GLIDE	1745	18						
HERALD								
BRAT 125	125	19			507320		145	
BRAT 250	250	19			507320		145	
CAFÉ 125	125	19			507320		145	
CLASSIC 125	125	19			507320		145	
RAMBLER 125	125	19			507320		145	
SCRAMBLER 125	125	19			507320		145	
HIGHLAND								
950 V2 MOTARD	950	0			507320		145	
950 V2 OUTBACK	950	0			507320		145	
HM								
DERAPAGE 4T	125	11		507124	507260		24	
CRF 150 R / R2	150	8			507355		167	
CRE F 125 X	125	8			507355		167	
CRM F 125 X	125	8			507355		167	
CR 125 MOTARD	125	3	6		507355		167	
CR 250 MOTARD	250	3			507355		167	
CRE 125 R	125	3			507355		167	
CRE 250 F	250	3			507355		167	
CRE 250 R	250	3			507355		167	

GALFER MOTO			GALFER MOTO	
Plaquettes arrière			Mâchoires arrière	
SEMI MÉTALLIQUES G1050	SEMI MÉTALLIQUES G1054	SINTERED G1380	N° Schéma	G2165
	507335		156	
	507335		156	
	507335		156	
	507335		156	
	507335		156	
	507335		156	
	507335		156	
	507335		156	
	507335		156	
	507335		156	
	507335		156	
	507335		156	
	507335		156	
	507335		156	
	507335		156	
	507335		156	
	507335		156	
	507335		156	
	507335		156	
	507335		156	
	507335		156	
	507335		156	
	507335		156	
	507335		156	
	507335		156	
	507335		156	
	507335		156	
	507335		156	
		519664	193	
		519664	193	
		519664	193	
		519664	193	
		519664	193	
		519664	193	
		519664	193	
507143	507230	507154	48	
507143	507230	507154	48	
	507297		122	
	507295		120	
		507181	37	
		507181	37	
	507319		144	
	507319		144	
	507319		144	
	507319		144	
	507319		144	

PLAQUETTES DE FREIN - MÂCHOIRES DE FREIN / BRAKE PADS - BRAKE SHOE

MOTEUR

CYCLE

PNEUMATIQUE

ATELIER

ACCESSOIRES



ÉLECTRICITÉ

FILTRATION

FREINAGE

TRANSMISSION

Modèle	Cylindre	Depuis	Jusqu'à	GALFER MOTO			GALFER MOTO	
				Plaquettes avant			Mâchoires avant	
				SEMI MÉTALLIQUES G1050	SEMI MÉTALLIQUES G1054	SINTERED G1380	N° Schéma	G2165
CRE 250 X	250	9			507355		167	
CRE 300 X	300	9			507355		167	
CRE 450 F	450	3			507355		167	
CRE 450 R	450	9			507355		167	
CRE 450 X	450	9			507355		167	
CRE 500 X	500	9			507355		167	
CRE F 490 X	490	7			507355		167	
CRF 250 MOTARD	250	3	6		507355		167	
CRF 250 R	250	9			507355		167	
CRF 450 MOTARD	450	3			507355		167	
CRF 450 R	450	9			507355		167	
EASY 230 F ENDURO	230	4			507355		167	
EASY 230 F MOTARD	230	4			507355		167	
EASY 230 F TRAIL ID	230	4			507355		167	
CRM 125 R	125	7			507355		167	
CRM 250 X	250	7			507355		167	
CRM F 450 R	450	9			507355		167	
CRM F 450 X	450	9			507355		167	
CRM F 490 X	490	7			507355		167	
DERAPAGE 2T COMPETICION	125	11			507356		168	
DERAPAGE 4T COMPETICION	125	11			507356		168	
DERAPAGE 2T	125	11			507356		168	
EASY 230 F TRAIL	230	4						
HONDA								
CRM 125, R	125	90		507074	507202		2	
CBR 1000 F	1000	87	88					
CBR 1000 R HURRICANE	1000	88						
GL 1500 SE GOLD WING	1500	91						
VFR 750 F	750	86	87					
CBR 400 R	400	87	87					
CBR 600 F/R HURRICANE	600	87	90					
NSR 250 R	250	87	87					
CR 125 R	125	94	94		507300		125	
CR 125 R	125	95	97		507300		125	
CR 125 R	125	98	1		507300		125	
CR 250 R	250	92	94		507300		125	
CR 250 R	250	95	96		507300		125	
CR 250 R	250	97	1		507300		125	
CR 500 R	500	92	94		507300		125	
CR 500 R	500	95	0		507300		125	
NX 4 DOMINATOR	400	99	2		507300		125	
NX 4 FALCON	400	3			507300		125	

 Plaquettes arrière			 Mâchoires arrière	
SEMI MÉTALLIQUES G1050	SEMI MÉTALLIQUES G1054	SINTERED G1380	N° Schéma	G2165
	507319		144	
	507319		144	
	507319		144	
	507319		144	
	507319		144	
	507319		144	
	507319		144	
	507319		144	
	507319		144	
	507319		144	
	507319		144	
	507319		144	
	507319		144	
	507319		144	
	507361		173	
	507361		173	
	507361		173	
	507361		173	
	507361		173	
	507361		173	
	507361		173	
	507369		185	
	507319		144	
507080	507215		88	
	507296		121	
	507296		121	
	507296		121	
	507296		121	
	507301		126	
	507301		126	
	507301		126	
	507319		144	
	507319		144	
	507319		144	
	507319		144	
	507319		144	
	507319		144	
	507319		144	
	507319		144	
	507319		144	
	507319		144	

MOTEUR

CYCLE

PNEUMATIQUE

ATELIER

ACCESSOIRES

ÉLECTRICITÉ

FILTRATION

FREINAGE

TRANSMISSION

PLAQUETTES DE FREIN - MÂCHOIRES DE FREIN / BRAKE PADS - BRAKE SHOE

MOTEUR

CYCLE

PNEUMATIQUE

ATELIER

ACCESSOIRES

ÉLECTRICITÉ

FILTRATION

FREINAGE

TRANSMISSION

Modèle	Cylindre	Depuis	Jusqu'à	GALFER MOTO			GALFER MOTO	
				Plaquettes avant			Mâchoires avant	
				SEMI MÉTALLIQUES G1050	SEMI MÉTALLIQUES G1054	SINTERED G1380	N° Schéma	G2165
XR 230	230	5			507300		125	
XR 250 L, R	250	91	93		507300		125	
XR 250 MOTARD	250	3			507300		125	
XR 250 R	250	94	2		507300		125	
XR 400 R	400	96			507300		125	
XR 600 R	600	93			507300		125	
XR 650 L	650	93			507300		125	
XR 650 R	650	0			507300		125	
XRE 300	300	9			507300		125	
XR 400 MOTARD (DF017SM)	400	5			507300		125	
XRE 300 C-ABS	300	10			507300		125	
CR 125 ENDURO	125	91			507300		125	
CR 125 R	125	87	91		507300		125	
CR 125 R	125	92	93		507300		125	
CR 250 ENDURO	250	91			507300		125	
CR 250 R	250	87	87		507300		125	
CR 250 R	250	88	88		507300		125	
CR 250 R	250	89	89		507300		125	
CR 250 R	250	90	91		507300		125	
CR 500 ENDURO	500	91			507300		125	
CR 500 R	500	85	89		507300		125	
CR 500 R	500	90	92		507300		125	
CRE 250	250	90			507300		125	
CRM 250 R	250	92			507300		125	
NT 650 HAWK GT	650	88			507300		125	
NTV 650	650	88			507300		125	
XL 250 R	250	90			507300		125	
XR 250 R	250	88	90		507300		125	
XR 600 R	600	91	92		507300		125	
CBR 750 SUPER AERO	750	88						
NX 650 DOMINATOR	650	88	92		507305		130	
NX 650 DOMINATOR	650	93	96		507305		130	
NXR 750 AFRICA TWIN	750	91			507305		130	
XL 600 V TRANSALP	600	91	93		507305		130	
XRV 650 AFRICA TWIN	650	88			507305		130	
CBR 250 HURRICANE	250	87			507305		130	
CBR 600 F	600	88	90		507305		130	
NX 500	500	88			507305		130	
VFR 400 R, Z	400	87			507305		130	
VT 250 SPADA	250	88			507305		130	
XRV 750 AFRICA TWIN	750	90	93		507305		130	
CBR 250 RJ	250	88			507305		130	

PLAQUETTES DE FREIN - MÂCHOIRES DE FREIN / BRAKE PADS - BRAKE SHOE

MOTEUR

CYCLE

PNEUMATIQUE

ATELIER

ACCESSOIRES

ÉLECTRICITÉ

FILTRATION

FREINAGE

TRANSMISSION

Modèle	Cylindre	Depuis	Jusqu'à	GALFER MOTO			N° Schéma	Mâchoires avant G2165
				Plaquettes avant				
				SEMI MÉTALLIQUES G1050	SEMI MÉTALLIQUES G1054	SINTERED G1380		
VTR 250	250	98	8		507305		130	
VTR 250 F	250	13			507305		130	
VTR 250 i	250	9			507305		130	
XL 600 V TRANSALP	600	94	96		507305		130	
CB 250 HORNET	250	96			507305		130	
XL 600 V TRANSALP	600	97	99		507305		130	
XL 650 V TRANSALP	650	0			507305		130	
XL 700 V TRANSALP	700	8			507305		130	
XRV 750 AFRICA TWIN	750	94			507305		130	
NTV 650 DEAUVILLE	650	98	1		507305		130	
FES 250 FORESIGHT DD	250	0			507305		130	
FES 250 FORZA, REFLEX	250	0	4		507305		130	
FES 250 JAZZ /ABS	250	0	4		507305		130	
PANTHEON 125	125	3			507305		130	
PANTHEON 150	150	3			507305		130	
CB 1	400	89	90		507305		130	
CB 250	250	15			507305		130	
CB 400 F	400	13			507305		130	
CB 400 FOUR	400	97	0		507305		130	
CB 400 X	400	13			507305		130	
CB 500 F	500	13	21		507305		130	
CB 500 F ABS	500	13	21		507305		130	
CB 500 X	500	13	18		507305		130	
CB 500 X	500	19	21		507305		130	
CB 500 X ABS	500	13	18		507305		130	
CB 500 X ABS	500	19	21		507305		130	
CB 500 X TRAVEL EDITION ABS	500	16	18		507305		130	
CB 650 F ABS	650	14			507305		130	
CBR 400 RR	400	88	97		507305		130	
CBR 500 R	500	13	21		507305		130	
CBR 500 R ABS	500	13	21		507305		130	
CBR 650 F ABS	650	14			507305		130	
CL 500	500	22			507305		130	
CMX 500 REBEL	500	18			507305		130	
FMX 650	650	5			507305		130	
NC 700 S	700	12			507305		130	
NC 700 X	700	12			507305		130	
NTV 400 BROSS	400	88			507305		130	
NTV 600 BROSS-HAWK	600	88			507305		130	
NTV 650 REVERE	650	91			507305		130	
VTZ 250 XELVIS	250	97			507305		130	

PLAQUETTES DE FREIN - MÂCHOIRES DE FREIN / BRAKE PADS - BRAKE SHOE

MOTEUR

CYCLE

PNEUMATIQUE

ATELIER

ACCESSOIRES

ÉLECTRICITÉ

FILTRATION

FREINAGE

TRANSMISSION

Modèle	Cylindre	Depuis	Jusqu'à	GALFER MOTO			N° Schéma	Mâchoires avant G2165
				SEMI MÉTALLIQUES G1050	SEMI MÉTALLIQUES G1054	SINTERED G1380		
CB 500 F	500	22			507305		130	
CB 650 R	650	19			507305		130	
CB 750 HORNET	750	22			507305		130	
CBR 500 R	500	22			507305		130	
CBR 650 R	650	19			507305		130	
NSR 250 R	250	88	92		507305		130	
NTV 650 BROS	650	88			507305		130	
NTV 650 REVERE, HAWK	650	88	90		507305		130	
XL 750 TRANSALP (RIGHT)	750	22			507305		130	
RVF 750 RR (RC45)	750	94						
VFR 400 R (NC30)	400	89	93					
RS 125 R	125	93		507087	507224		68	
RS 250 R	250	93	96	507087	507224		68	
RS 125 R	125	89	89	507087	507224		68	
RS 125 R	125	90	92	507087	507224		68	
NSF 250 R	250	12		507087	507224		68	
RS 250 R	250	90	92	507087	507224		68	
CBR 600 F2	600	91	94		507315		140	
CBF 500 N	500	4			507315		140	
VT 1100 C2 ACE	1100	97			507315		140	
VT 1300 CS	1300	10			507315		140	
VT 1300 CX	1300	10			507315		140	
919 (USA)	900	1			507315		140	
CB 1000 BIG ONE	1000	93			507315		140	
CB 1300	1300	92	97		507315		140	
CB 900 SF HORNET	900	1			507315		140	
CBR 900 RR	900	92	92		507315		140	
CBR 900 RR	900	93	97		507315		140	
VTR 1000 F FIRESTORM	1000	97	99		507315		140	
VTR 1000 F SUPER HAWK 996 (USA)	1000	97	99		507315		140	
CB 1100	1100	10	12		507315		140	
CB 1100 EX	1100	15			507315		140	
CB 1300	1300	3	4		507315		140	
CB 1300 S	1300	5	9		507315		140	
CB 1300 SUPER BOL D'OR / ABS	1300	5			507315		140	
CB 1300 SUPER FOUR / ABS	1300	5			507315		140	
CB 400 SUPER BOL D'OR	400	5	13		507315		140	
CB 400 SUPER BOL D'OR	400	14			507315		140	
CB 400 SUPER FOUR	400	5	13		507315		140	
CB 400 SUPER FOUR	400	14			507315		140	
CBR 600 F4	600	99	0		507315		140	
CBR 600 F4 i SPORT	600	1	10		507315		140	

PLAQUETTES DE FREIN - MÂCHOIRES DE FREIN / BRAKE PADS - BRAKE SHOE

MOTEUR

CYCLE

PNEUMATIQUE

ATELIER

ACCESSOIRES

ÉLECTRICITÉ

FILTRATION

FREINAGE

TRANSMISSION

Modèle	Cylindre	Depuis	Jusqu'à	GALFER MOTO			N° Schéma	Mâchoires avant G2165
				Plaquettes avant				
				SEMI MÉTALLIQUES G1050	SEMI MÉTALLIQUES G1054	SINTERED G1380		
CBR 600 RR	600	3	4		507315		140	
CBR 900 RR	900	98	99		507315		140	
CBR 900 RR (929)	929	0	1		507315		140	
CBR 900 RR (954)	954	2			507315		140	
RVT 1000 RC 51 (USA)	1000	2			507315		140	
VTR 1000 SP-1	1000	0	1		507315		140	
VTR 1000 SP-2	1000	2			507315		140	
599 (USA)	600	0	6		507315		140	
CB 600 HORNET	600	98	99		507315		140	
CB 600 HORNET /S	600	0	6		507315		140	
CB 750 SEVEN FIFTY	750	92			507315		140	
CBF 1000	1000	6			507315		140	
CBF 600 /S	600	4	7		507315		140	
CBF 600 /S	600	8			507315		140	
CBR 400 RR	400	98			507315		140	
CBR 600 F3	600	95	98		507315		140	
VTX 1300 S/C RETRO	1300	3			507315		140	
CBR 1000 RR FIREBLADE	1000	4	5		507315		140	
CBR 600 RR	600	5	6		507315		140	
599 (USA) ABS	600	7			507315		140	
CB 1100	1100	13			507315		140	
CB 1300 F	1300	10			507315		140	
CB 1300 S	1300	10			507315		140	
CB 600 HORNET ABS	600	7			507315		140	
CBF 1000 ABS	1000	11			507315		140	
CBF 500 ABS	500	4			507315		140	
CBF 600 S ABS	600	8			507315		140	
CBR 600 F ABS	600	11			507315		140	
NC 700 S ABS	700	12			507315		140	
NC 700 X ABS	700	12			507315		140	
NC D INTEGRA	700	12			507315		140	
XL 700 V TRANSALP ABS	700	8			507315		140	
CB 1100 N	1100	17			507315		140	
CB 1100 RS	1100	17			507315		140	
CRF 1000 L AFRICA TWIN	1000	15			507315		140	
CRF 1000 L AFRICA TWIN ADVENTURE SPORTS	1000	18			507315		140	
CRF 1100 L AFRICA TWIN	1100	20			507315		140	
CRF 1100 L AFRICA TWIN ADVENTURE SPORTS	1100	20			507315		140	
FJS 400 SILVER WING	400	6		507094	507231		46	
FJS 600 SILVER WING	600	1		507094	507231		46	
FJS 600 SILVER WING ABS	600	3		507094	507231		46	

PLAQUETTES DE FREIN - MÂCHOIRES DE FREIN / BRAKE PADS - BRAKE SHOE

CGN
LE SENS DU DÉTAIL

MOTEUR

CYCLE

PNEUMATIQUE

ATELIER

ACCESSOIRES

ÉLECTRICITÉ

FILTRATION

FREINAGE

TRANSMISSION

Modèle	Cylindre	Depuis	Jusqu'à	Plaquettes avant			Mâchoires avant	
				SEMI MÉTALLIQUES G1050	SEMI MÉTALLIQUES G1054	SINTERED G1380	N° Schéma	G2165
SILVER WING 400	400	2	8	507094	507231		46	
CB 1000 SF	1000	93		507094	507231		46	
CBR 1000 F	1000	89	92	507094	507231		46	
F6C 1500 VALKYRIA	1500	97		507094	507231		46	
ST 1100 PAN-EUROPEAN	1100	90	90	507094	507231		46	
ST 1100 PAN-EUROPEAN	1100	91	95	507094	507231		46	
VFR 700 F INTERCEPTOR	700	88		507094	507231		46	
VFR 750 F	750	90	93	507094	507231		46	
VFR 750 F	750	94	97	507094	507231		46	
VFR 750 F,J,L,M	750	88	89	507094	507231		46	
VT 1100 C2 SHADOW ACE	1100	95	96	507094	507231		46	
VT 1200 MAGNA	1200	95		507094	507231		46	
DN - 01	680	8	9	507094	507231		46	
DN - 01 CONCEPT	680	10		507094	507231		46	
SILVER WING T 400	400	9		507094	507231		46	
SW-T 600	600	11		507094	507231		46	
NSR 250 R	250	93						
CB 500	500	97	97		507320		145	
CB 500 S	500	98			507320		145	
NX 650 DOMINATOR	650	97			507320		145	
SLR 650	650	96			507320		145	
VIGOR 650	650	99			507320		145	
NSR 125 F	125	88						
NSR 125 F (1)	125	90						
NSR 125 R	125	89						
NSR 125 R (1)	125	90						
VT 1300 CS ABS	1300	10			507331		154	
VT 1300 CX ABS	1300	10			507331		154	
CB 1100 X 11 ELEVEN	1100	0		507113	507333	507182	53	
CBR 1100 XX i SUP. BLACKBIRD	1100	0		507113	507333	507182	53	
CBR 1100 XX SUP. BLACKBIRD	1100	97	99	507113	507333	507182	53	
GL 1800 GOLD WING	1800	1	5	507113	507333	507182	53	
GL 1800 GOLD WING	1800	6		507113	507333	507182	53	
NRX 1800 VALKYRIE RUNE	1800	3		507113	507333	507182	53	
NTV 650 V DEAUVILLE	650	2		507113	507333	507182	53	
ST 1100 PAN EUROPEAN	1100	96	1	507113	507333	507182	53	
ST 1100 PAN EUROPEAN CBS/ABS/TCS	1100	96	1	507113	507333	507182	53	
ST 1300 PAN-EUROPEAN	1300	2	7	507113	507333	507182	53	
VFR 800	800	98	0	507113	507333	507182	53	
VFR 800 Vtec (INTERCEPTOR USA)	800	1	5	507113	507333	507182	53	
VTX 1800 C	1800	1		507113	507333	507182	53	
VTX 1800 RETRO	1800	3		507113	507333	507182	53	

PLAQUETTES DE FREIN - MÂCHOIRES DE FREIN / BRAKE PADS - BRAKE SHOE

CGN
LE SENS DU DÉTAIL

MOTEUR

CYCLE

PNEUMATIQUE

ATELIER

ACCESSOIRES

ÉLECTRICITÉ

FILTRATION

FREINAGE

TRANSMISSION

Modèle	Cylindre	Depuis	Jusqu'à	GALFER MOTO			N° Schéma	Mâchoires avant G2165
				Plaquettes avant				
				SEMI MÉTALLIQUES G1050	SEMI MÉTALLIQUES G1054	SINTERED G1380		
XL VARADERO	1000	99	2	507113	507333	507182	53	
XL VARADERO	1000	3		507113	507333	507182	53	
CTX 1300 C ABS	1300	14		507113	507333	507182	53	
NTV 700 V DEAUVILLE	700	6		507113	507333	507182	53	
ST 1300 PAN-EUROPEAN ABS	1300	8		507113	507333	507182	53	
VFR 800	800	6		507113	507333	507182	53	
VFR 800 ABS	800	6	13	507113	507333	507182	53	
XL VARADERO ABS	1000	4		507113	507333	507182	53	
CBR 1000 RR R	1000	20		507116	507252	507164	14	
CBR 1000 RR R SP	1000	20		507116	507252	507164	14	
RC 213 V	1000	15		507116	507252	507164	14	
XL 125 V VARADERO	125	1		507125	507261		51	
CB 350 H 'NESS	350	21		507125	507261		51	
CB 350 RS	350	21		507125	507261		51	
CB 200 X	200	21		507125	507261		51	
CBR 125 R	125	4	10	507125	507261		51	
CT 125	125	21		507125	507261		51	
MONKEY	125	18		507125	507261		51	
X BLADE 200	200	21		507125	507261		51	
X-4 LOW DOWN	1300	0			507349		163	
CB 1300	1300	1	2		507349		163	
CB 400 SUPER FOUR	400	2	4		507349		163	
VT 750 C2 SHADOW ABS	750	10			507349		163	
CB 1300	1300	98	0		507349		163	
CRF 150 R	150	7			507355		167	
CR 125 R	125	2	4		507355		167	
CR 125 R	125	5	7		507355		167	
CR 250 R	250	2	4		507355		167	
CR 250 R	250	5	7		507355		167	
CRF 230 L	230	8			507355		167	
CRF 230 M	230	9			507355		167	
CRF 250 R	250	4	7		507355		167	
CRF 250 R	250	8	14		507355		167	
CRF 250 R	250	15	18		507355		167	
CRF 250 R	250	19			507355		167	
CRF 250 X	250	4			507355		167	
CRF 250 XR LD	250	13			507355		167	
CRF 450 F/R	450	1	3		507355		167	
CRF 450 F/R	450	4	7		507355		167	
CRF 450 F/R	450	8	14		507355		167	
CRF 450 L	450	19			507355		167	
CRF 450 R	450	15	18		507355		167	

PLAQUETTES DE FREIN - MÂCHOIRES DE FREIN / BRAKE PADS - BRAKE SHOE

CGN
LE SENS DU DÉTAIL

MOTEUR

CYCLE

PNEUMATIQUE

ATELIER

ACCESSOIRES



ÉLECTRICITÉ

FILTRATION

FREINAGE

TRANSMISSION

Modèle	Cylindre	Depuis	Jusqu'à	Plaquettes avant			Mâchoires avant	
				SEMI MÉTALLIQUES G1050	SEMI MÉTALLIQUES G1054	SINTERED G1380	N° Schéma	G2165
CRF 450 R	450	19			507355		167	
CRF 450 RALLY	450	13			507355		167	
CRF 450 RX	450	18			507355		167	
CRF 450 RX COUNTRY	450	17			507355		167	
CRF 450 X	450	4			507355		167	
CRF 450 XR LD	450	13			507355		167	
XR 250 R	250	3			507355		167	
CBF 1000 ABS	1000	6	10	507140	507277	507173	54	
GL 1800 GOLD WING 12YM	1800	12		507140	507277	507173	54	
GL 1800 GOLD WING F6 40th	1800	15	17	507140	507277	507173	54	
GL 1800 GOLD WING F6B	1800	13		507140	507277	507173	54	
GL 1800 GOLD WING	1800	18		507140	507277	507173	54	
ADV 350	350	22		507142	507278	507174	67	
FORZA 125	125	15	20	507142	507278	507174	67	
FORZA 125	125	21		507142	507278	507174	67	
FORZA 350	350	21		507142	507278	507174	67	
NSS 300 FORZA	300	19		507142	507278	507174	67	
SH 125 i SCOOPY CBS	125	13		507142	507278	507174	67	
SH 150 i SCOOPY ABS	150	13		507142	507278	507174	67	
SH SCOOPY 300 i ABS	300	15		507142	507278	507174	67	
SH SCOOPY 350i	350	21		507142	507278	507174	67	
FAZE 250	250	10		507142	507278	507174	67	
FES 250 FORZA EX	250	5		507142	507278	507174	67	
FES 250 FORZA X / Z	250	5		507142	507278	507174	67	
NSS 300 FORZA	300	13	18	507142	507278	507174	67	
S WING 125 / ABS	125	7		507142	507278	507174	67	
S WING 150	150	7		507142	507278	507174	67	
SH 125 i SCOOPY (D-D)	125	9	12	507142	507278	507174	67	
SH 125 i SCOOPY ABS	125	13		507142	507278	507174	67	
SH 150 i SCOOPY (D-D)	150	9		507142	507278	507174	67	
SH 150 i SCOOPY CBS	150	13		507142	507278	507174	67	
SH SCOOPY 300	300	7	10	507142	507278	507174	67	
SH SCOOPY 300	300	11	15	507142	507278	507174	67	
SH SCOOPY 300 ABS	300	7	14	507142	507278	507174	67	
ADV 150	150	19		507142	507278	507174	67	
599 (USA)	600	7			507366		182	
CB 600 HORNET	600	7			507366		182	
CBR 600 F	600	11			507366		182	
CBR 1000 RR FIREBLADE	1000	6	7		507366		182	
CBR 1000 RR FIREBLADE	1000	8			507366		182	
CBR 1000 RR FIREBLADE C-ABS	1000	9	16		507366		182	
CBR 600 RR	600	7			507366		182	

 Plaquettes arrière			 Mâchoires arrière	
SEMI MÉTALLIQUES G1050	SEMI MÉTALLIQUES G1054	SINTERED G1380	N° Schéma	G2165
	507319		144	
	507319		144	
	507319		144	
	507319		144	
	507319		144	
	507319		144	
	507319		144	
507140	507277	507173	54	
507140	507277	507173	54	
507140	507277	507173	54	
507140	507277	507173	54	
507128	507167		44	
507128	507167		44	
507128	507167		44	
507128	507167		44	
507128	507167		44	
507128	507167		44	
507128	507167		44	
507128	507167		44	
507128	507167		44	
507140	507277	507173	54	
507140	507277	507173	54	
507140	507277	507173	54	
507140	507277	507173	54	
507140	507277	507173	54	
507140	507277	507173	54	
507140	507277	507173	54	
507140	507277	507173	54	
507140	507277	507173	54	
507140	507277	507173	54	
507140	507277	507173	54	
507140	507277	507173	54	
507140	507277	507173	54	
507140	507277	507173	54	
	507369		185	
507128	507167		44	
507128	507167		44	
507128	507167		44	
	507207		177	
	507207		177	
	507207		177	
	507207		177	

MOTEUR

CYCLE

PNEUMATIQUE

ATELIER

ACCESSOIRES

ÉLECTRICITÉ



FILTRATION

FREINAGE

TRANSMISSION

PLAQUETTES DE FREIN - MÂCHOIRES DE FREIN / BRAKE PADS - BRAKE SHOE

Modèle	Cylindre	Depuis	Jusqu'à	GALFER MOTO			N° Schéma	Mâchoires avant G2165
				Plaquettes avant				
				SEMI MÉTALLIQUES G1050	SEMI MÉTALLIQUES G1054	SINTERED G1380		
CBR 600 RR	600	9			507366		182	
CBR 600 RR C-ABS	600	9	12		507366		182	
CBR 600 RR C-ABS	600	13	17		507366		182	
CBR 1000 RR FIREBLADE	1000	17	19		507366		182	
CBR 1000 RR FIREBLADE SP	1000	14	16		507366		182	
CBR 1000 RR FIREBLADE SP2	1000	17	19		507366		182	
CBR 600 RR	600	18			507366		182	
CB 1000 R	1000	8	17					
CROSSRUNNER X	800	15	16					
VFR 800 ABS	800	14	16					
CB 1000 R ABS	1000	8	17					
CROSSRUNNER X	800	11	14					
CBR 250 R	250	86	10		507371		187	
CBR 250 RR ABS	250	17			507371		187	
CBR 250 R	250	11			507371		187	
CBR 300 R ABS	300	14			507371		187	
CMX REBEL 300	300	18			507371		187	
CTX 700	700	13			507371		187	
CTX 700 ABS	700	13			507371		187	
CTX 700 N	700	13			507371		187	
CTX 700 N ABS	700	13			507371		187	
NC 750 S	750	14			507371		187	
NC 750 S ABS	750	14			507371		187	
NC 750 X	750	14			507371		187	
NC 750 X ABS	750	14			507371		187	
NC D INTEGRA	750	14			507371		187	
NC D INTEGRA S	750	14			507371		187	
NM4-VULTUS	750	15			507371		187	
CBR 250 R C-ABS	250	11			507371		187	
CMX 1100 REBEL	1100	21			507371		187	
FORZA 750	750	21			507371		187	
NT 1100	1100	22			507371		187	
X-ADV 750	750	17			507371		187	
CBF 250 TWISTER	250	16						
CBR 125 R	125	11						
MSX 125	125	13	16					
MSX 125	125	17	20					
MSX 125 GROM	125	21						
CB 300 R ABS	300	10	18					
CRF 250 L	250	13						
CRF 250 LD	250	13						
CRF 250 M	250	14						

 Plaquettes arrière			 Mâchoires arrière	
SEMI MÉTALLIQUES G1050	SEMI MÉTALLIQUES G1054	SINTERED G1380	N° Schéma	G2165
	507207		177	
	507207		177	
	507207		177	
	507207		177	
	507207		177	
	507207		177	
507140	507277	507173	54	
507140	507277	507173	54	
	507301		126	
507094	507231		46	
507128	507167		44	
507128	507167		44	
507128	507167		44	
507128	507167		44	
507128	507167		44	
507128	507167		44	
507128	507167		44	
507128	507167		44	
507128	507167		44	
507128	507167		44	
507128	507167		44	
507128	507167		44	
507128	507167		44	
507128	507167		44	
507128	507167		44	
507128	507167		44	
507128	507167		44	
507140	507277	507173	54	
507128	507167		44	
507134	507271		79	
507134	507271		79	
507134	507271		79	
507134	507271		79	
507134	507271		79	
507140	507277	507173	54	
	507369		185	
	507369		185	
	507369		185	

MOTEUR

CYCLE

PNEUMATIQUE

ATELIER

ACCESSOIRES

ÉLECTRICITÉ

FILTRATION

FREINAGE

TRANSMISSION

PLAQUETTES DE FREIN - MÂCHOIRES DE FREIN / BRAKE PADS - BRAKE SHOE

Modèle	Cylindre	Depuis	Jusqu'à	GALFER MOTO			N° Schéma	Mâchoires avant G2165
				SEMI MÉTALLIQUES G1050	SEMI MÉTALLIQUES G1054	SINTERED G1380		
CRF 250 RALLY	250	17						
CRF 300 L	300	21						
CRF 300 RALLY	300	21						
VFR 1200 X CROSSTOURER	1200	12						
VFR 1200 X CROSSTOURER DCT	1200	12						
VFR 1200 X CROSSTOURER TRAV. ED.	1200	16						
VFR 1200 X CROSSTOURER TRAV. ED. DCT	1200	16						
@ 125	125	0					7	507378
@ 150	150	0					7	507378
200 L, R (1)	200	85						
600 STEED	600	88						
ANF 125 INNOVA	125	3	6					
ANF 125 INNOVA	125	7						
CA 125 REBEL	125	95	98				4	507375
CA 125 REBEL	125	99					4	507375
CB 125 F	125	15	16					
CB 125 J	125	76	76				3	507374
CB 125 RS	125	83						
CB 250	250	88	91					
CB 250	250	92						
CB 250 TWO FIFTY	250	92						
CB 300 R	300	9	18					
CB 350 SG	350	87						
CB 400 SS	400	1						
CB 500	500	95	96					
CB 750 NIGHTHAWK	750	91						
CBF 125	125	9					7	507378
CBF 150	150	4					7	507378
CBF 250	250	4					7	507378
CBF 250 TWISTER	250	4	15				7	507378
CBX 125 CUSTOM	125	88						
CG 125	125	4						
CG 125	125	80	85				2	507373
CG 125	125	86	3				2	507373
CH 125 SPACY	125	83					2	507373
CHA 125 SPACY	125	98						
CITYFLY 125	125	99						
CMX REBEL 250 (GRIMECA)	250	0	7				4	507375
CMX REBEL 250 (NISSIN)	250	96	97				4	507375
CMX REBEL 250 (NISSIN)	250	98					4	507375
CR 125 R	125	84	86					

GALFER MOTO			GALFER MOTO	
Plaquettes arrière			Mâchoires arrière	
SEMI MÉTALLIQUES G1050	SEMI MÉTALLIQUES G1054	SINTERED G1380	N° Schéma	G2165
	507369		185	
	507369		185	
	507369		185	
507140	507277	507173	54	
507140	507277	507173	54	
507140	507277	507173	54	
507140	507277	507173	54	
507132	507269	507185	109	
507132	507269	507185	109	
507080	507215		88	
	507296		121	
507134	507271		79	
507134	507271		79	
507107	507246	507158	102	
507109	507248		103	
507088	507225		31	
507086	507223		9	
	507296		121	
507128	507167		44	
507128	507167		44	
	507234	507180	90	
	507301		126	
507128	507167		44	
507128	507167		44	
507094	507231		46	
507134	507271		79	
	507234	507180	90	
507079	507214		38	
507086	507223		9	
			2	507373
			2	507373
507079	507214		38	
507109	507248		103	
507109	507248		103	
507107	507246	507158	102	
507107	507246	507158	102	
507076	507211		86	

PLAQUETTES DE FREIN - MÂCHOIRES DE FREIN / BRAKE PADS - BRAKE SHOE

MOTEUR

CYCLE

PNEUMATIQUE

ATELIER

ACCESSOIRES



ÉLECTRICITÉ

FILTRATION

FREINAGE



TRANSMISSION

Modèle	Cylindre	Depuis	Jusqu'à	GALFER MOTO			GALFER MOTO	
				Plaquettes avant			Mâchoires avant	
				SEMI MÉTALLIQUES G1050	SEMI MÉTALLIQUES G1054	SINTERED G1380	N° Schéma	G2165
CR 250 R	250	84	86					
CR 500 R	500	84	84					
CRF 150 F	150	3	6				3	507374
CRF 230 F	230	4					3	507374
CT 500 R	500	84						
DT 125 (I)	125	87						
DYLAN 125	125	2					7	507378
DYLAN 150	150	2					7	507378
EMI e	EL	22						
FES 250 FORESIGHT	250	97	1				5	507377
FTR 223	223	0	2					
FUSION	250	90						
GB 250 CLUB MAN	250	95						
MBX 125 RWB, F	125	84						
MT 125 R	125	78					2	507373
MTX 125	125	87	87				2	507373
MTX 125 CAMEL	125	88	90				2	507373
MTX 125 R	125	86	87				2	507373
MTX 125 R S (I)	125	88	90				2	507373
MTX 125 R2HI	125	91					2	507373
NH 125	125	88					2	507373
NS 125 F	125	86	87				2	507373
NX 125 (I)	125	90	92				3	507374
NX 125 (I) TRANSCITY	125	93					3	507374
NX 250 DOMINATOR	250	97						
NX 650 AUSTRALIA	650	88					4	507375
NX 650 DOMINATOR	650	87	88				4	507375
PANTHEON 125	125	98	2				5	507377
PANTHEON 150	150	98	2				5	507377
PC 800 PACIFIC COAST	800	88						
PCX 125	125	18					7	507378
PCX 125	125	10	17				7	507378
PCX 150	150	18					7	507378
PCX 150	150	13	17				7	507378
PCX 160	160	18					7	507378
PS 125i	125	6					7	507378
PS 150i	150	6					7	507378
PS 250	250	4					5	507377
SH 125 i SCOOPY	125	5	8				7	507378
SH 125 i SCOOPY (TAMBOR TRAS)	125	9	12				7	507378
SH 125 MODE	125	13					7	507378
SH 125 SCOOPY	125	1	4				7	507378

				
Plaquettes arrière			Mâchoires arrière	
SEMI MÉTALLIQUES G1050	SEMI MÉTALLIQUES G1054	SINTERED G1380	N° Schéma	G2165
507076	507211		86	
507076	507211		86	
	507319		144	
	507319		144	
507076	507211		86	
507080	507215		88	
507132	507269	507185	109	
507132	507269	507185	109	
		519662	191	
507113	507333	507182	53	
507132	507269	507185	109	
507132	507269	507185	109	
	507296		121	
507079	507214		38	
507076	507211		86	
507080	507215		88	
507080	507215		88	
507080	507215		88	
507080	507215		88	
507087	507224		68	
507080	507215		88	
507080	507215		88	
507080	507215		88	
	507319		144	
	507296		121	
	507296		121	
507113	507333	507182	53	
507113	507333	507182	53	
507128	507167		44	
	507369		185	
507147	507286	507177	59	
	507369		185	
507147	507286	507177	59	
	507369		185	
507132	507269	507185	109	
507132	507269	507185	109	
507113	507333	507182	53	
507132	507269	507185	109	
507132	507269	507185	109	
507147	507286	507177	59	
507132	507269	507185	109	

PLAQUETTES DE FREIN - MÂCHOIRES DE FREIN / BRAKE PADS - BRAKE SHOE

Modèle	Cylindre	Depuis	Jusqu'à	GALFER MOTO			GALFER MOTO	
				Plaquettes avant			Mâchoires avant	
				SEMI MÉTALLIQUES G1050	SEMI MÉTALLIQUES G1054	SINTERED G1380	N° Schéma	G2165
SH 150 i SCOOPY	150	5					7	507378
SH 150 i SCOOPY (TAMBOR TRAS)	150	9					7	507378
SH 150 SCOOPY	150	1	4				7	507378
SUPER CUB	125	19					7	507378
TLR 200 E	200	86						
VF 750 C MAGNA	750	95						
V LX 400 STEED	400	89	95					
VT 1100 C SHADOW	1100	94	94					
VT 125 SHADOW	125	0					4	507375
VT 250 F INTEGRA	250	87	87					
VT 400 SHADOW	400	97	1					
VT 400 SHADOW SLASHER	400	2						
VT 600 CD SHADOW VLX	600	94						
VT 600 SHADOW	600	88	93					
VT 600 SHADOW	600	6						
VT 750 C SHADOW	750	97						
VT 750 C2 SHADOW BLACK	750	10						
VT 750 DC BLACK WIDOW	750	2						
VT 750 DC SPIRIT	750	7						
V-TWIN MAGNA	250	97						
VTZ 250	250	88	96					
XL 125 L PD (1)	125	87	88				3	507374
XL 125 L, R (1)	125	85	85				3	507374
XL 125 P3 (1)	125	91	97				3	507374
XL 125 R	125	86	88					
XL 125 R	125	89	97				2	507373
XL 125 R	125	98	0				3	507374
XL 125 R2 (1)	125	87	88				3	507374
XL 200	200	83	85				3	507374
XL 200 L PD (1)	200	87					3	507374
XL 200 PDD	200	86	86				3	507374
XL 200 R	200	86	86				3	507374
XL 200 R2D	200	86	86				3	507374
XL 350 R	350	84						
XL 500 R	500	83					4	507375
XL 600 LM/RM/R	600	86	86				4	507375
XL 600 LMH	600	87					4	507375
XL 600 R, RD, LC	600	83	85				4	507375
XL 600 R, RG, RM	600	86	86				4	507375
XL 600 V TRANSALP	600	87	90				4	507375
XR 125 L	125	3					3	507374
XR 250 R	250	84	87					

 Plaquettes arrière			 Mâchoires arrière	
SEMI MÉTALLIQUES G1050	SEMI MÉTALLIQUES G1054	SINTERED G1380	N° Schéma	G2165
507132	507269	507185	109	
507132	507269	507185	109	
507132	507269	507185	109	
507080	507215		88	
507128	507167		44	
507128	507167		44	
507094	507231		46	
	507234	507180	90	
	507301		126	
507128	507167		44	
507128	507167		44	
507128	507167		44	
	507296		121	
507128	507167		44	
507094	507231		46	
507094	507231		46	
507094	507231		46	
507094	507231		46	
507128	507167		44	
	507301		126	
507080	507215		88	
507080	507215		88	
507080	507215		88	
507076	507211		86	
			2	507373
	507319		144	
507080	507215		88	
			3	507374
507080	507215		88	
507080	507215		88	
507080	507215		88	
507076	507211		86	
507076	507211		86	
507076	507211		86	
507076	507211		86	
507076	507211		86	
507076	507211		86	
507076	507211		86	
	507319		144	
507076	507211		86	

PLAQUETTES DE FREIN - MÂCHOIRES DE FREIN / BRAKE PADS - BRAKE SHOE

MOTEUR

CYCLE

PNEUMATIQUE

ATELIER

ACCESSOIRES

ÉLECTRICITÉ

FILTRATION

FREINAGE

TRANSMISSION

Modèle	Cylindre	Depuis	Jusqu'à	GALFER MOTO Plaquettes avant			N° Schéma	GALFER MOTO Mâchoires avant G2165
				SEMI MÉTALLIQUES G1050	SEMI MÉTALLIQUES G1054	SINTERED G1380		
XR 350 R	350	84					3	507374
XR 500 R	500	84					4	507375
XR 600 R	600	84	86				3	507374
XR 600 R	600	87	90				3	507374
XL 750 TRANSALP (LEFT)	750	22						
HONDA 3 WHEELS								
ATC 200 R	200	85		507076	507211		86	
ATC 250 R	250	85	86	507076	507211		86	
ATC 350	350	85			507295		120	
ATC 200 R	200	84			507295		120	
ATC 200 XD	200	83			507295		120	
ATC 250 R	250	82	84		507295		120	
ATC 350 X	350	86			507295		120	
ATC 200 X	200	83	85		507360		172	
ATC 200 X	200	86	87		507360		172	
ATC 125 M	125	84	87					
ATC 185 S	185	81	83					
ATC 200	200	81	83					
ATC 200 E BIG RED	200	82	83					
ATC 200 ES BIG RED	200	84						
ATC 200 M	200	84	85					
ATC 200 S	200	84	86					
ATC 200 X	200	83						
ATC 250 R	250	81	81					
HONDA 4 WHEELS								
TRX 700 XX	700	8						
FL 350R ODYSSEY	350	85	87					
FL 400 R PILOT	400	89	90					
TRX 250 R	250	87	89	507076	507211		86	
TRX 250 R	250	90			507295		120	
TRX 250 X	250	87	91		507295		120	
TRX 300 EX	300	93	8		507295		120	
TRX 300 X9	300	9			507295		120	
TRX 400 EX	400	99	8		507295		120	
TRX 400 X9	400	9	8		507295		120	
TRX 420 FOURTRAX RANCHER AT	420	9						
TRX 450 R	450	4	9					
TRX 125	125	85	88					
TRX 200	200	84						
TRX 250	250	85	87					
TRX 250 EX	250	1						
TRX 250 RECON	250	3	5					

GALFER MOTO			GALFER MOTO	
Plaquettes arrière			Mâchoires arrière	
SEMI MÉTALLIQUES G1050	SEMI MÉTALLIQUES G1054	SINTERED G1380	N° Schéma	G2165
507076	507211		86	
507076	507211		86	
507079	507214		38	
507134	507271		79	
507076	507211		86	
507076	507211		86	
507076	507211		86	
	507295		120	
	507295		120	
	507360		172	
	507360		172	
	507360		172	
			2	507373
			2	507373
			2	507373
			2	507373
			2	507373
			2	507373
			2	507373
	507360		172	
507086	507223		9	
	507319		144	
			5	507377
			5	507377
	507295		120	
	507295		120	
	507295		120	
	507295		120	
	507295		120	
	507295		120	
	507295		120	
	507295		120	
	507319		144	
			2	507373
			5	507377
			5	507377
	507295		120	
	507295		120	

PLAQUETTES DE FREIN - MÂCHOIRES DE FREIN / BRAKE PADS - BRAKE SHOE

MOTEUR

CYCLE

PNEUMATIQUE

ATELIER

ACCESSOIRES



ÉLECTRICITÉ

FILTRATION

FREINAGE

TRANSMISSION

Modèle	Cylindre	Depuis	Jusqu'à	GALFER MOTO Plaquettes avant			N° Schéma	Mâchoires avant G2165
				SEMI MÉTALLIQUES G1050	SEMI MÉTALLIQUES G1054	SINTERED G1380		
TRX 250 X9	250	9						
TRX 300-2WD	300	88	93					
TRX 420 FOURTRAX RANCHER	420	7					5	507377
TRX 500 FAC/FEC/FMC/FPAC 2/4 WD	500	12						
HONDA BRAZIL								
BIZ 125	125	11						
CG 150 TITAN	150	10						
NXR 150 BROS	150	12						
HONDA COLOMBIA								
CBZ 160	160							
GL 145	145							
TITAN 125	125							
TWISTER 250	250							
HONDA INDONESIA								
CBR 150 R	150	11			507305		130	
CITY SPORT ONE	125	11		507125	507261		51	
CB 150 R STREETFIRE	150	11		507125	507261		51	
MEGA PRO CW	150	11		507125	507261		51	
TIGER DOUBLE	200	11		507125	507261		51	
TIGER SINGLE	200	11		507125	507261		51	
SUPRA - X 125 PGM FI	125	10		507125	507261		51	
SUPRA - X 125 R	125	10		507125	507261		51	
MEGA PRO	160	10						
MEGA PRO SW	150	11						
HONDA MALASIA								
FUTURE 125 DD	125	12						
FUTURE 125 DT	125	12						
FUTURE 125 DT SPOKE WHEEL	125	12						
WAVE 125	125	10						
CRF 250 L	250	12			507300		125	
HONDA RED MOTO								
300 RR	300	15		507118	507254		106	
4 RIDE	260	16		507118	507254		106	
COTA 4RT	260	15		507118	507254		106	
COTA 4RT RACE REPLICIA	260	15		507118	507254		106	
CRF 150 R	150	7			507355		167	
CRF 250 R	250	15	18		507355		167	
CRF 250 R	250	19			507355		167	
CRF 250 R ENDURO	250	15			507355		167	
CRF 250 X	250	14			507355		167	
CRF 300 R ENDURO	300	15			507355		167	
CRF 300 X	300	14			507355		167	

 Plaquettes arrière			 Mâchoires arrière	
SEMI MÉTALLIQUES G1050	SEMI MÉTALLIQUES G1054	SINTERED G1380	N° Schéma	G2165
	507295		120	
			7	507378
	507295		120	
	507295		120	
	507319		144	
507134	507271		79	
	507319		144	
507088	507225		31	
507086	507223		9	
	507295		120	
507088	507225		31	
507134	507271		79	
	507234	507180	90	
507134	507271		79	
507134	507271		79	
507134	507271		79	
507134	507271		79	
507134	507271		79	
507134	507271		79	
507125	507261		51	
507125	507261		51	
507125	507261		51	
507134	507271		79	
	507319		144	
	507295		120	
	507319		144	
	507319		144	
	507319		144	
	507319		144	
	507319		144	
	507319		144	
	507319		144	

PLAQUETTES DE FREIN - MÂCHOIRES DE FREIN / BRAKE PADS - BRAKE SHOE

MOTEUR

CYCLE

PNEUMATIQUE

ATELIER

ACCESSOIRES

ÉLECTRICITÉ

FILTRATION

FREINAGE

TRANSMISSION

Modèle	Cylindre	Depuis	Jusqu'à	GALFER MOTO			GALFER MOTO	
				Plaquettes avant			Mâchoires avant	
				SEMI MÉTALLIQUES G1050	SEMI MÉTALLIQUES G1054	SINTERED G1380	N° Schéma	G2165
CRF 450 R	450	15	18		507355		167	
CRF 450 R	450	19			507355		167	
CRF 450 RS	450	15			507355		167	
CRF 450 RX	450	15			507355		167	
CRF 450 RX COUNTRY	450	15			507355		167	
CRF 450 RS	450	17			507355		167	
CRF 450 RX	450	17			507355		167	
CRF 450 RXC	450	17			507355		167	
HOREX								
VR6	1250	12		507116	507252	507164	14	
HUSABERG								
350 MC	350	91	92	507081	507216		23	
500 MC	500	91	92	507081	507216		23	
501 MC	501	89	92	507081	507216		23	
501 MC ENDURO	501	91	92	507081	507216		23	
500 CROSS	500	93	93	507081	507216		23	
450 FS	450	4	4		507320		145	
650 FS	650	3	3		507320		145	
350 MC	350	94			507320		145	
501 MC	501	94	99		507320		145	
350 FC	350	95	99		507320		145	
350 FE	350	95	99		507320		145	
400 FE	400	0			507320		145	
450 FC/FE	450	4			507320		145	
501 FC	501	95	99		507320		145	
501 FE	501	95	99		507320		145	
550 FC/FE	550	4			507320		145	
600 FC	600	95	99		507320		145	
600 FE	600	95	99		507320		145	
650 FC/FE	650	4			507320		145	
450 FSE	450	5			507320		145	
650 FS	650	4			507320		145	
125 TE	125	11			507358		170	
250 FE	250	13			507358		170	
250 TE	250	11			507358		170	
300 TE	300	11			507358		170	
350 FE	350	13			507358		170	
390 FE	390	10			507358		170	
450 FE	450	12			507358		170	
450 FX	450	10			507358		170	
501 FE	501	13			507358		170	
570 FE	570	9			507358		170	

PLAQUETTES DE FREIN - MÂCHOIRES DE FREIN / BRAKE PADS - BRAKE SHOE

MOTEUR

CYCLE

PNEUMATIQUE

ATELIER

ACCESSOIRES

ÉLECTRICITÉ

FILTRATION

FREINAGE

TRANSMISSION

Modèle	Cylindre	Depuis	Jusqu'à	Plaquettes avant			N° Schéma	Mâchoires avant G2165
				SEMI MÉTALLIQUES G1050	SEMI MÉTALLIQUES G1054	SINTERED G1380		
570 FS	570	10			507358		170	
HUSABERG 4 WHEELS								
EF 400 /E	400	99		507081	507216		23	
EF 501 /E	500	99		507081	507216		23	
EF 600 /E	600	99		507081	507216		23	
HUSQVARNA								
125 CR	125	93	99	507081	507216		23	
125 CR, WR	125	93	99	507081	507216		23	
125 WR	125	93	99	507081	507216		23	
250 CR, WR	250	93	99	507081	507216		23	
125 CR	125	91	91	507081	507216		23	
125 CROSS	125	89		507081	507216		23	
125 WR	125	91		507081	507216		23	
250 CR	250	91		507081	507216		23	
250 CROSS	250	89		507081	507216		23	
250 WR	250	91		507081	507216		23	
260 WR	260	91		507081	507216		23	
350 TE 4T	350	91	94	507081	507216		23	
360 CR	360	92	94	507081	507216		23	
500 CROSS	500	89	92	507081	507216		23	
510 TE	510	89	89	507081	507216		23	
510 TE	510	90	94	507081	507216		23	
600 WRK	600	89		507081	507216		23	
610 TC, TE 4T	610	91	94	507081	507216		23	
360 WR	360	92	94		507295		120	
125 WXE	125	7			507300		125	
610 TE	610	92	94	507086	507223		9	
450 SM R	450	1	4		507320		145	
570 SM R	570	1			507320		145	
610 SM R	610	0	4		507320		145	
NOX	600	1			507320		145	
125 CR	125	94	99		507320		145	
125 CR	125	0	3		507320		145	
125 SM S	125	0			507320		145	
125 SM S 4T	125	11			507320		145	
125 TE 4T	125	11	13		507320		145	
125 WR	125	94	99		507320		145	
125 WR	125	0	5		507320		145	
125 WRE	125	94	99		507320		145	
125 WRE	125	0			507320		145	
250 CR	250	94	99		507320		145	
250 CR	250	0	3		507320		145	

PLAQUETTES DE FREIN - MÂCHOIRES DE FREIN / BRAKE PADS - BRAKE SHOE

MOTEUR

CYCLE

PNEUMATIQUE

ATELIER

ACCESSOIRES



ÉLECTRICITÉ

FILTRATION

FREINAGE

TRANSMISSION

Modèle	Cylindre	Depuis	Jusqu'à	GALFER MOTO			GALFER MOTO	
				Plaquettes avant			Mâchoires avant	
				SEMI MÉTALLIQUES G1050	SEMI MÉTALLIQUES G1054	SINTERED G1380	N° Schéma	G2165
250 WR	250	94	99		507320		145	
250 WR	250	0			507320		145	
350 TE	350	94	99		507320		145	
360 CR	360	94	99		507320		145	
360 WR	360	94	99		507320		145	
360 WR	360	0			507320		145	
510 TE	510	95	99		507320		145	
510 TE	510	0	4		507320		145	
570 TE	570	0			507320		145	
610 TC	610	94	99		507320		145	
610 TC	610	0			507320		145	
610 TE	610	94	99		507320		145	
610 TE	610	0			507320		145	
630 TE	630	10			507320		145	
TE 410	410	94	99		507320		145	
TE 410/E	410	0			507320		145	
MOAB	650	12			507320		145	
TR 650 STRADA	650	12			507320		145	
TR 650 TERRA	650	12			507320		145	
450 SM S	450	1	4		507320		145	
570 SM S	570	1			507320		145	
610 SM S	610	0	4		507320		145	
610LT	610	0			507320		145	
NUDA 900	900	12			507320		145	
450 SM R	450	5	5		507320		145	
510 SM R	510	5	5		507320		145	
610 SM ie	610	7			507320		145	
610 SM R	610	5	5		507320		145	
610 SM R	610	6			507320		145	
630 SM	630	10			507320		145	
630 SMS	630	11			507320		145	
NUDA 900 R	900	11			507320		145	
EE 5	EL	20			507344		158	
630 SMR	630	6			507358		170	
125 CR	125	4	4		507358		170	
125 CR	125	5			507358		170	
125 WR	125	6			507358		170	
250 CR	250	4	4		507358		170	
250 CR	250	5			507358		170	
250 TC	250	4	4		507358		170	
250 TC	250	5	13		507358		170	
250 TE	250	5			507358		170	

				
Plaquettes arrière			Mâchoires arrière	
SEMI MÉTALLIQUES G1050	SEMI MÉTALLIQUES G1054	SINTERED G1380	N° Schéma	G2165
507143	507230	507154	48	
507143	507230	507154	48	
507143	507230	507154	48	
507143	507230	507154	48	
507143	507230	507154	48	
507143	507230	507154	48	
507143	507230	507154	48	
507143	507230	507154	48	
507143	507230	507154	48	
507143	507230	507154	48	
507143	507230	507154	48	
507143	507230	507154	48	
507143	507230	507154	48	
507143	507230	507154	48	
507143	507230	507154	48	
	507322		147	
	507322		147	
	507322		147	
	507324		149	
	507324		149	
	507324		149	
	507324		149	
	507324		149	
	507347		161	
	507347		161	
	507347		161	
	507347		161	
	507347		161	
	507347		161	
	507347		161	
	507344		158	
507078	507213		87	
507143	507230	507154	48	
507143	507230	507154	48	
507143	507230	507154	48	
507143	507230	507154	48	
507143	507230	507154	48	
507143	507230	507154	48	
507143	507230	507154	48	
507143	507230	507154	48	
507143	507230	507154	48	

MOTEUR

CYCLE

PNEUMATIQUE

ATELIER

ACCESSOIRES

ÉLECTRICITÉ

FILTRATION

FREINAGE

TRANSMISSION

PLAQUETTES DE FREIN - MÂCHOIRES DE FREIN / BRAKE PADS - BRAKE SHOE

MOTEUR

CYCLE

PNEUMATIQUE

ATELIER

ACCESSOIRES



ÉLECTRICITÉ

FILTRATION

FREINAGE

TRANSMISSION

Modèle	Cylindre	Depuis	Jusqu'à	GALFER MOTO			N° Schéma	Mâchoires avant G2165
				Plaquettes avant				
				SEMI MÉTALLIQUES G1050	SEMI MÉTALLIQUES G1054	SINTERED G1380		
250 TE R	250	13	13		507358		170	
300 WR	300	9			507358		170	
310 TE	310	9			507358		170	
310 TE R	310	13			507358		170	
449 TE	449	11			507358		170	
450 TC	450	5			507358		170	
450 TE	450	5			507358		170	
510 TC	510	4	4		507358		170	
510 TC	510	5			507358		170	
510 TE	510	5			507358		170	
TC 449	450	11			507358		170	
TE 449	450	11			507358		170	
TE 511	511	11			507358		170	
530 RR	530	9			507358		170	
450 SM / RR	450	6			507358		170	
510 SM R	510	6			507358		170	
SMR 449	450	11			507358		170	
SMR 511	511	11			507358		170	
STR 650 CRC	650	7			507358		170	
E-go	EL	12						
504	504	83						
125 CR, CX	125	84						
125 WRK	125	88						
240 CR, CX	240	84						
240 CR, WR	240	87						
240 WRK	240	88						
250 WR	250	84						
250 WR, XC	250	87						
260 WRK	260	88						
400 WR	400	84						
430 AE	430	88						
430 AUTO, CR, WR, XC	430	87						
500 CR, CX	500	84						
500 XC	500	87						
510 4T ENDURO	510	84						
510 TC	510	88						
510 TE	510	87						
510 TX CROSS COUNTRY	510	88						
HUSQVARNA A								
NORDEN 901	900	22		507143	507230	507154	48	
701 ENDURO ABS	701	16			507320		145	
701 SVARTPILEN	701	18	19		507320		145	

				
Plaquettes arrière			Mâchoires arrière	
SEMI MÉTALLIQUES G1050	SEMI MÉTALLIQUES G1054	SINTERED G1380	N° Schéma	G2165
507143	507230	507154	48	
507143	507230	507154	48	
507143	507230	507154	48	
507143	507230	507154	48	
507143	507230	507154	48	
507143	507230	507154	48	
507143	507230	507154	48	
507143	507230	507154	48	
507143	507230	507154	48	
507143	507230	507154	48	
507143	507230	507154	48	
507143	507230	507154	48	
507143	507230	507154	48	
	507324		149	
	507347		161	
	507347		161	
	507347		161	
	507347		161	
	507347		161	
507143	507230	507154	48	
507074	507202		2	
507074	507202		2	
	507298		123	
507074	507202		2	
	507298		123	
	507298		123	
507074	507202		2	
	507298		123	
	507298		123	
507074	507202		2	
	507298		123	
	507298		123	
507074	507202		2	
	507298		123	
507074	507202		2	
	507298		123	
	507298		123	
	507298		123	
	507324		149	
	507322		147	
	507324		149	

PLAQUETTES DE FREIN - MÂCHOIRES DE FREIN / BRAKE PADS - BRAKE SHOE

MOTEUR

CYCLE

PNEUMATIQUE

ATELIER

ACCESSOIRES

ÉLECTRICITÉ

FILTRATION

FREINAGE

TRANSMISSION

Modèle	Cylindre	Depuis	Jusqu'à	GALFER MOTO			N° Schéma	Mâchoires avant G2165
				Plaquettes avant				
				SEMI MÉTALLIQUES G1050	SEMI MÉTALLIQUES G1054	SINTERED G1380		
701 SVARTPILEN	701	20			507320		145	
701 VITPILEN	701	18	19		507320		145	
701 VITPILEN	701	20			507320		145	
701 SUPERMOTO	701	15			507320		145	
401 SVARTPILEN	375	17	18		507320		145	
401 SVARTPILEN	375	19			507320		145	
401 VITPILEN	375	17	18		507320		145	
401 VITPILEN	375	19			507320		145	
SVARTPILEN 125	125	21			507320		145	
125 TC	125	14			507358		170	
125 TE	125	14	17		507358		170	
125 TE	125	21			507358		170	
125 TX	125	18			507358		170	
150 TE	150	22			507358		170	
250 FC	250	14			507358		170	
250 FE	250	14			507358		170	
250 i TE	250	17			507358		170	
250 TC	250	14			507358		170	
250 TE	250	14	16		507358		170	
300 i TE	300	17			507358		170	
300 TE	300	14	16		507358		170	
350 FC	350	14			507358		170	
350 FE	350	14			507358		170	
450 FC	450	14			507358		170	
450 FE	450	14			507358		170	
501 FE	501	14			507358		170	
450 FS	450	17			507358		170	
HYOSUNG								
AQUILA 700 GV i	700	10		507076	507211		86	
ST 7	700	10		507076	507211		86	
XR 400	400	5			507300		125	
EXIV 125	125	12		507085	507222	507152	25	
EXCEED 150	150	3		507088	507225		31	
GEN 4.0	EL	10			507234	507180	90	
GD 250 N	250	14		507102	507239	507156	3	
GD 250 R	250	14		507102	507239	507156	3	
GV 1000	1000	4			507359		171	
GV 650 AQUILIA	650	4			507359		171	
GT 650 i	650	9	11					
GT 650 Pi	650	13						
GT 650 Ri	650	9						
EXCEED 125	125	3						

PLAQUETTES DE FREIN - MÂCHOIRES DE FREIN / BRAKE PADS - BRAKE SHOE

Modèle	Cylindre	Depuis	Jusqu'à	GALFER MOTO			N° Schéma	Mâchoires avant G2165
				Plaquettes avant				
				SEMI MÉTALLIQUES G1050	SEMI MÉTALLIQUES G1054	SINTERED G1380		
GEN 2.0	EL	10						
GRAND PRIX 125	125	98						
GV 125	125	0	4					
HYOSUNG 4 WHEELS								
TE 400	400	5		507086	507223		9	
TE 450	450	6		507086	507223		9	
INDIAN MOTORCYCLE								
CHIEF BLACKHAWK	1720	11			507203		118	
CHIEF BLACKHAWK DARK	1720	11			507203		118	
CHIEF BOMBER	1720	9			507203		118	
CHIEF CLASSIC	1720	9	13		507203		118	
CHIEF DARK HORSE	1720	9	15		507203		118	
CHIEF DELUXE	1720	9			507203		118	
CHIEF ROADMASTER	1720	9			507203		118	
CHIEF STANDARD	1720	9	13		507203		118	
CHIEF VINTAGE	1720	9	13		507203		118	
CHIEF BOBBER DARK HORSE	1890	21		507094	507231		46	
CHIEF CLASSIC	1720	14		507094	507231		46	
CHIEF DARK HORSE	1811	16	20	507094	507231		46	
CHIEF DARK HORSE	1890	21		507094	507231		46	
CHIEF VINTAGE	1811	14		507094	507231		46	
CHIEFTAIN	1811	14		507094	507231		46	
CHIEFTAIN DARK HORSE	1811	16	20	507094	507231		46	
CHIEFTAIN DARK HORSE	1890	21		507094	507231		46	
CHIEFTAIN LIMITED	1890	21		507094	507231		46	
ROADMASTER	1811	15	20	507094	507231		46	
ROADMASTER	1890	21		507094	507231		46	
ROADMASTER DARK HORSE	1890	21		507094	507231		46	
ROADMASTER LIMITED	1890	21		507094	507231		46	
SPRINGFIELD	1811	16	20	507094	507231		46	
SPRINGFIELD	1890	21		507094	507231		46	
SPRINGFIELD DARK HORSE	1890	21		507094	507231		46	
SUPER CHIEF LIMITED	1890	21		507094	507231		46	
CHALLENGER DARK HORSE	1768	21		507094	507231		46	
CHALLENGER LIMITED	1768	21		507094	507231		46	
SCOUT BOBBER	1130	18	21		507320		145	
SCOUT BOBBER TWENTY	1130	19			507320		145	
SCOUT SIXTY	1130	18			507320		145	
SCOUT FTR	1130	18	21		507320		145	
FTR 1200	1200	19		507116	507252	507164	14	
FTR 1200 RALLY	1200	20		507116	507252	507164	14	
FTR 1200 S	1200	19		507116	507252	507164	14	

GALFER MOTO			GALFER MOTO	
Plaquettes arrière			Mâchoires arrière	
SEMI MÉTALLIQUES G1050	SEMI MÉTALLIQUES G1054	SINTERED G1380	N° Schéma	G2165
507085	507222	507152	25	
507105	507243		1	
	507221		33	
507086	507223		9	
507086	507223		9	
507078	507213		87	
507078	507213		87	
507078	507213		87	
507078	507213		87	
507078	507213		87	
507078	507213		87	
507078	507213		87	
507078	507213		87	
	507362		178	
	507362		178	
	507362		178	
	507362		178	
	507362		178	
	507362		178	
	507362		178	
	507362		178	
	507362		178	
	507362		178	
	507362		178	
	507362		178	
	507362		178	
	507362		178	
	507362		178	
	507362		178	
	507362		178	
	507362		178	
	507362		178	
	507199		83	
	507199		83	
	507322		147	
	507322		147	
	507322		147	
	507199		83	
	507199		83	
	507199		83	

PLAQUETTES DE FREIN - MÂCHOIRES DE FREIN / BRAKE PADS - BRAKE SHOE

MOTEUR

CYCLE

PNEUMATIQUE

ATELIER

ACCESSOIRES



ÉLECTRICITÉ

FILTRATION

FREINAGE

TRANSMISSION

Modèle	Cylindre	Depuis	Jusqu'à	GALFER MOTO Plaquettes avant			N° Schéma	Mâchoires avant G2165
				SEMI MÉTALLIQUES G1050	SEMI MÉTALLIQUES G1054	SINTERED G1380		
FTR R CARBON	1200	21		507116	507252	507164	14	
SCOUT SIXTY	999	16			507363		179	
SCOUT	1130	15	17		507363		179	
ISR								
6 PISTON RACING CALIPER		93						
6 PISTON RACING CALIPER		93						
ITALJET								
GRIFON	900	0		507074	507202		2	
DRAGSTER	125	0	10	507077	507212	507151	6	
DRAGSTER	180	0		507077	507212	507151	6	
FORMULA 125	125	97		507077	507212	507151	6	
BAZOOKA	650	6		507079	507214		38	
GRIFON	650	6		507079	507214		38	
JUPITER	250	2		507115	507251	507163	66	
DRAGSTER	125	22		507116	507252	507164	14	
DRAGSTER	200	22		507116	507252	507164	14	
DRAGSTER	250	7		507129	507266	507168	18	
JACK 125	125	7		507132	507269	507185	109	
JACK 150	150	7		507132	507269	507185	109	
350 BOSS, ROAD MASTER	350	83						
JET SET	125	2						
JET SET	150	2						
MILLENNIUM 125	125	0	1					
MILLENNIUM 125	125	2						
MILLENNIUM 150	150	0	1					
MILLENNIUM 150	150	2						
TORPEDO 125	125	99	6					
TORPEDO 125	125	7						
TORPEDO 150	150	0						
JIALING COLOMBIA								
JH 125 CICLON	125							
JH 125 G	125							
JH 125-6 PEGASO	125							
JH 150 E LIBRETTY	150							
JINCHENG 4 WHEELS								
JC 125 S RACCOON	125	5		507108	507247	507159	34	
JINCHENG COLOMBIA								
JC 125	125							
JC 125 7B	125							
JC 125-17C GENTLE	125							
JC 150 DRAGON	150							
JC 150 Y	150	5						

				
Plaquettes arrière			Mâchoires arrière	
SEMI MÉTALLIQUES G1050	SEMI MÉTALLIQUES G1054	SINTERED G1380	N° Schéma	G2165
	507199		83	
507078	507213		87	
	507322		147	
507078	507213		87	
507077	507212	507151	6	
507077	507212	507151	6	
507077	507212	507151	6	
507079	507214		38	
507079	507214		38	
507104	507242	507157	63	
507143	507230	507154	48	
507143	507230	507154	48	
507129	507266	507168	18	
507132	507269	507185	109	
507132	507269	507185	109	
507074	507202		2	
507129	507266	507168	18	
507129	507266	507168	18	
507081	507216		23	
507129	507266	507168	18	
507081	507216		23	
507129	507266	507168	18	
507077	507212	507151	6	
507132	507269	507185	109	
507077	507212	507151	6	
507086	507223		9	
	507295		120	
507086	507223		9	
507088	507225		31	
507086	507223		9	
507079	507214		38	
507124	507260		24	
507088	507225		31	
507124	507260		24	
	507302		127	

PLAQUETTES DE FREIN - MÂCHOIRES DE FREIN / BRAKE PADS - BRAKE SHOE

CGN
LE SENS DU DÉTAIL

MOTEUR

CYCLE

PNEUMATIQUE

ATELIER

ACCESSOIRES

ÉLECTRICITÉ

FILTRATION

FREINAGE

TRANSMISSION

Modèle	Cylindre	Depuis	Jusqu'à	GALFER MOTO Plaquettes avant			N° Schéma	Mâchoires avant G2165
				SEMI MÉTALLIQUES G1050	SEMI MÉTALLIQUES G1054	SINTERED G1380		
JC 250 6	250	5						
JC 250-6 MANTIS	250							
JC125 T6 QUEEN	125							
JJUAN								
TOURING / SPORT ROAD BIKE	TRAS				507320		145	
SCOOTER AXIAL 2P	DEL			507116	507252	507164	14	
SPORT BIKE 2P	TRAS			507116	507252	507164	14	
RADIAL 4P 34/30 100mm	DEL							
RADIAL 4P 34/30 108mm	DEL							
TOURING / SPORT ROAD BIKE RADIAL 4P	DEL							
TOURING BIKE AXIAL 4P	DEL							
TOURING BIKE AXIAL 2P	DEL							
SCOOTER 3P CBS	DEL							
JOTAGAS								
JTG 250	250	14		507118	507254		106	
JTG 280	280	14		507118	507254		106	
JTG 300	300	14		507118	507254		106	
JTG 300 JT	300	12	13	507118	507254		106	
KASEA 4 WHEELS								
KS 150	150	3			507221		33	
KU 150	150	3			507221		33	
SKYHAWK 125	125	3			507221		33	
SKYHAWK 170	170	3			507221		33	
SKYHAWK 250	250	3			507221		33	
KAWASAKI								
KZ 1000 A, B, C, D, E, G, GL, H	1000	77	79		507206		115	
KZ 500 B1, B2	500	80	81		507206		115	
KZ 550 A1, B	550	80	80		507206		115	
KZ 650 B, B2, B3, C1, C2, C3	650	79			507206		115	
KZ 650 D, D2, DIA	650	78			507206		115	
KZ 750 G, GL	750	80	80		507206		115	
GPZ 400 F2	400	88						
GTR 1000	1000	94						
VN-CLASSIC	1500	96	97					
VN-CLASSIC TOURER RIGHT/DER	1500	98	99					
BJ 250 ESTRELLA RS	250	99		507081	507216		23	
KMX 125	125	88	88	507081	507216		23	
KMX 200	200	88		507081	507216		23	
KMX 250	250	89		507081	507216		23	
KX 125	125	83	83	507081	507216		23	
KX 250	250	83	84	507081	507216		23	

PLAQUETTES DE FREIN - MÂCHOIRES DE FREIN / BRAKE PADS - BRAKE SHOE

MOTEUR

CYCLE

PNEUMATIQUE

ATELIER

ACCESSOIRES



ÉLECTRICITÉ

FILTRATION

FREINAGE

TRANSMISSION

Modèle	Cylindre	Depuis	Jusqu'à	GALFER MOTO			N° Schéma	Mâchoires avant G2165
				Plaquettes avant				
				SEMI MÉTALLIQUES G1050	SEMI MÉTALLIQUES G1054	SINTERED G1380		
KX 500	500	84	87	507081	507216		23	
KLE 500	500	91		507081	507216		23	
KLR 650 TENGAI	650	89	91	507081	507216		23	
ZZR 250	250	98		507081	507216		23	
KMX 125	125	89	98	507081	507216		23	
GPZ 500 S	500	93		507081	507216		23	
XANTHUS 400	400	92		507081	507216		23	
KLR 650 C1/C2	650	95	7	507081	507216		23	
KMX 125	125	99		507081	507216		23	
ZR 250 BALIUS II	250	2		507081	507216		23	
KL 250 SUPER SHERPA	250	0		507081	507216		23	
KLR 650	650	87	88	507081	507216		23	
KX 125	125	88	88	507081	507216		23	
KX 250	250	87	87	507081	507216		23	
KX 250	250	88	88	507081	507216		23	
KX 500	500	88	88	507081	507216		23	
GPX 1000 R	1000	88			507299		124	
GPX 500	500	88			507299		124	
GPX 600 R	600	88			507299		124	
GPX 750 R	750	87			507299		124	
GPZ 750 R	750	87			507299		124	
ZEPHYR 1100	1100	93	95		507299		124	
ZEPHYR 750	750	91			507299		124	
ZG 1000 CONCOURS	1000	94			507299		124	
ZX 10	1000	86			507299		124	
ZX 10 TOMCAT	1000	88	90		507299		124	
ZX 1000 RX NINJA	1000	88			507299		124	
ZX 750 F2 NINJA	750	88			507299		124	
ZXR 600 NINJA	600	90	90		507299		124	
GPX 400 R	400	87	87		507299		124	
ZEPHYR 1100	1100	92	92		507299		124	
ZX 600 NINJA ZX-6	600	93	94		507299		124	
ZZR 1100	1100	90	92		507299		124	
ZZR 500	500	90			507299		124	
ZZR 600	600	91	92		507299		124	
ZZR 600 HAMA	600	90			507299		124	
ZEPHYR 1100 RIGHT/DER	1100	96			507299		124	
GPZ 900 R	900	90	96		507299		124	
ZZR 400	400	90	0		507299		124	
KLX 250	250	9			507300		125	
KLX 250 SF	250	9			507300		125	
D 250 TRACKER	250	3			507300		125	

 Plaquettes arrière			 Mâchoires arrière	
SEMI MÉTALLIQUES G1050	SEMI MÉTALLIQUES G1054	SINTERED G1380	N° Schéma	G2165
507081	507216		23	
	507299		124	
	507299		124	
	507299		124	
507085	507222	507152	25	
	507306		131	
	507306		131	
	507323		148	
507106			101	
	507325		150	
	507330		153	
	507299		124	
	507299		124	
	507299		124	
	507299		124	
	507299		124	
	507299		124	
	507299		124	
	507299		124	
	507299		124	
	507299		124	
	507299		124	
	507299		124	
	507299		124	
	507299		124	
	507299		124	
	507299		124	
	507299		124	
	507299		124	
	507306		131	
	507307		132	
	507307		132	
	507307		132	
	507307		132	
	507307		132	
	507307		132	
	507307		132	
	507307		132	
	507325		150	
507128	507167		44	
	507221		33	
	507221		33	
	507319		144	

MOTEUR

CYCLE

PNEUMATIQUE

ATELIER

ACCESSOIRES

ÉLECTRICITÉ

FILTRATION

FREINAGE

TRANSMISSION

PLAQUETTES DE FREIN - MÂCHOIRES DE FREIN / BRAKE PADS - BRAKE SHOE

CGN
LE SENS DU DÉTAIL

MOTEUR

CYCLE

PNEUMATIQUE

ATELIER

ACCESSOIRES



ÉLECTRICITÉ

FILTRATION

FREINAGE

TRANSMISSION

Modèle	Cylindre	Depuis	Jusqu'à	GALFER MOTO			N° Schéma	Mâchoires avant G2165
				Plaquettes avant				
				SEMI MÉTALLIQUES G1050	SEMI MÉTALLIQUES G1054	SINTERED G1380		
KLX 250 D TRACKER	250	0			507300		125	
KLX 250 S	250	5	7		507300		125	
KLX 300 R	300	96	20		507300		125	
KLX 400 R	400	3			507300		125	
KX 125	125	95	2		507300		125	
KX 125	125	3	3		507300		125	
KX 125	125	4	5		507300		125	
KX 125	125	6			507300		125	
KX 250	250	95	2		507300		125	
KX 250	250	3	3		507300		125	
KX 500	500	95			507300		125	
KZF 250	250	88		507085	507222	507152	25	
KLX 125	125	10		507086	507223		9	
KLX 125 D-TRACKER	125	10		507086	507223		9	
KLX 140 L	140	8		507086	507223		9	
Z 650	650	17			507305		130	
Z 650 RS	650	20			507305		130	
EX 250 NINJA F	250	88	1		507306		131	
GPX 250 R NINJA	250	87			507306		131	
ZEPHYR 500	500	91			507306		131	
ZEPHYR 550	550	93	95		507306		131	
ZR 400 Z Zephyr	400	89			507306		131	
ZZR 250 (EX 250 HI)	250	90	97		507306		131	
GPX 400 R	400	88			507306		131	
KR 1250	1250	89			507306		131	
KR-1 250B2	250	88	89		507306		131	
ZX-4 (400)	400	88			507306		131	
ZXR 250	250	89			507306		131	
KR-IS 250C2	250	90			507306		131	
ZXR 400	400	95	98		507309		134	
ZX 1100	1100	93			507309		134	
ZXR 750 R	750	91	95		507309		134	
ZXR 750 STINGER	750	89	90		507309		134	
ZZR 1100	1100	93	1		507309		134	
ZZR 1200	1200	1			507309		134	
ZRX 1100	1100	97	0		507309		134	
ZRX 1200	1200	4			507309		134	
ZRX 1200 R	1200	4			507309		134	
ZRX 1200 S	1200	2	3		507309		134	
ZRX 1200 S	1200	4			507309		134	
ZX-12 R	1200	0	3		507309		134	
GPZ 1100 S	1100	95			507309		134	

 Plaquettes arrière			 Mâchoires arrière	
SEMI MÉTALLIQUES G1050	SEMI MÉTALLIQUES G1054	SINTERED G1380	N° Schéma	G2165
	507319		144	
	507319		144	
	507319		144	
	507319		144	
	507319		144	
	507319		144	
	507319		144	
	507319		144	
	507319		144	
	507319		144	
	507319		144	
	507319		144	
507081	507216		23	
	507221		33	
	507221		33	
	507221		33	
507128	507167		44	
507128	507167		44	
	507299		124	
	507299		124	
	507299		124	
	507299		124	
	507299		124	
	507299		124	
	507306		131	
	507306		131	
	507306		131	
	507306		131	
	507306		131	
	507307		132	
	507299		124	
	507307		132	
	507307		132	
	507307		132	
	507307		132	
	507317		142	
	507317		142	
	507317		142	
	507317		142	
	507317		142	
507128	507167		44	

PLAQUETTES DE FREIN - MÂCHOIRES DE FREIN / BRAKE PADS - BRAKE SHOE

MOTEUR

CYCLE

PNEUMATIQUE

ATELIER

ACCESSOIRES



ÉLECTRICITÉ

FILTRATION

FREINAGE

TRANSMISSION

Modèle	Cylindre	Depuis	Jusqu'à	GALFER MOTO			GALFER MOTO	
				Plaquettes avant			Mâchoires avant	
				SEMI MÉTALLIQUES G1050	SEMI MÉTALLIQUES G1054	SINTERED G1380	N° Schéma	G2165
ZX-12 R	1200	4			507309		134	
ZXR 400	400	89	89		507309		134	
ZXR 400	400	90	94		507309		134	
KDX 200	200	89	89		507310		135	
KDX 200 SR	200	90			507310		135	
KDX 250 R	250	92			507310		135	
KLX 250 R	250	92			507310		135	
KX 125	125	89	94		507310		135	
KX 250	250	89	93		507310		135	
KX 500	500	89	93		507310		135	
KDX 125 SR	125	90			507310		135	
KDX 220	220	99			507310		135	
KLX 650 R	650	93			507310		135	
KLX 650 S	650	93			507310		135	
KX 250	250	94	94		507310		135	
KX 500	500	94	94		507310		135	
NINJA 125	125	19		507088	507225		31	
NINJA 250 R	250	8	12	507088	507225		31	
NINJA 300 R	300	13		507088	507225		31	
NINJA 300 R SP (ABS)	300	13		507088	507225		31	
Z 125	125	19		507088	507225		31	
Z 250 SL	250	15		507088	507225		31	
Z 300	300	15		507088	507225		31	
ZX 25 R	250	20	21	507088	507225		31	
W 800	800	19		507088	507225		31	
KLR 650	650	21		507088	507225		31	
KLR 650 ADVENTURE	650	21		507088	507225		31	
KLR 650 TRAVELER	650	21		507088	507225		31	
VERSYS X 300	300	17		507088	507225		31	
NINJA 400	400	18		507088	507225		31	
Z 125 PRO	125	17		507088	507225		31	
Z 400	400	20		507088	507225		31	
VERSYS 1000	1000	12	14		507315		140	
VERSYS 1000	1000	15	18		507315		140	
VERSYS 1000 GRAND TOURER	1000	17			507315		140	
VERSYS 1000 TOURER	1000	17			507315		140	
KLX 1000 RIGHT/DER	1000	4			507315		140	
EN VULCAN S	650	15			507315		140	
EN VULCAN S CAFÉ	650	16			507315		140	
EN VULCAN S SE	650	16			507315		140	
NINJA 650	650	17			507315		140	
VERSYS 650 ABS LEFT /IZQ ABS	650	15			507315		140	

 Plaquettes arrière			 Mâchoires arrière	
SEMI MÉTALLIQUES G1050	SEMI MÉTALLIQUES G1054	SINTERED G1380	N° Schéma	G2165
	507357		169	
507081	507216		23	
	507221		33	
	507221		33	
	507221		33	
	507221		33	
	507221		33	
507085	507222	507152	25	
	507319		144	
	507319		144	
	507319		144	
	507319		144	
507088	507225		31	
507088	507225		31	
507088	507225		31	
507088	507225		31	
507088	507225		31	
507088	507225		31	
507088	507225		31	
	507325		150	
507128	507167		44	
507128	507167		44	
507128	507167		44	
507128	507167		44	
	507307		132	
	507307		132	
	507307		132	
	507307		132	
	507325		150	
	507331		154	
	507331		154	
	507331		154	
507128	507167		44	
507128	507167		44	

PLAQUETTES DE FREIN - MÂCHOIRES DE FREIN / BRAKE PADS - BRAKE SHOE

CGN
LE SENS DU DÉTAIL

MOTEUR

CYCLE

PNEUMATIQUE

ATELIER

ACCESSOIRES



ÉLECTRICITÉ

FILTRATION

FREINAGE

TRANSMISSION

Modèle	Cylindre	Depuis	Jusqu'à	Plaquettes avant			N° Schéma	Mâchoires avant G2165
				SEMI MÉTALLIQUES G1050	SEMI MÉTALLIQUES G1054	SINTERED G1380		
VERSYS 650 ABS RIGHT /DER ABS	650	15			507315		140	
Z 750	750	7			507315		140	
Z 750 ABS	750	7			507315		140	
VERSYS 1000	1000	19			507315		140	
VERSYS 1000 SE	1000	19			507315		140	
Z 900 RS	900	18			507315		140	
Z 900 RS CAFÉ	900	18			507315		140	
ZX 25 R	250	22			507315		140	
Z 1000 H2	1000	20			507315		140	
Z 900 RS SE	900	22			507315		140	
Z 900 SE	900	22			507315		140	
Z 1000	1000	7	8		507315		140	
Z 1000	1000	8	9		507315		140	
Z 1000 H2 SE	1000	21			507315		140	
KLR 650	650	8	9		507234	507180	90	
ZEPHYR 400 / X	400	2			507321		146	
ZEPHYR 550	550	96			507321		146	
ZX-6R	600	95	97		507321		146	
ZX-9R NINJA	900	94	95		507321		146	
ZZR 600	600	93			507321		146	
ZX-6R	600	98	99		507321		146	
ZX-6R	600	0	2		507321		146	
ZX-6R 636	636	2	2		507321		146	
ZX-9R NINJA	900	96	97		507321		146	
ZX-9R NINJA	900	98	99		507321		146	
ZX-9R NINJA	900	0	1		507321		146	
ZXR 400	400	99			507321		146	
ER-6 F / NINJA 650 R (USA) RIGHT / DER	650	5			507321		146	
ER-6 F / NINJA 650 R (USA) RIGHT / DER ABS	650	6			507321		146	
ER-6 N RIGHT / DER	650	5			507321		146	
ER-6 N RIGHT / DER ABS	650	6			507321		146	
GPZ 1100 (ZX1100E1) RIGHT/DER	1100	95			507321		146	
VERSYS 650 RIGHT / DER	650	6	14		507321		146	
VERSYS 650 RIGHT / DER ABS	650	6	14		507321		146	
Z 750 RIGHT/DER	750	4	6		507321		146	
Z 750 S RIGHT/DER	750	5	6		507321		146	
ZRX 400 / II	400	1			507321		146	
ZX 10R NINJA	1000	4	5		507321		146	
ZX 10R NINJA	1000	6	7		507321		146	
ZX-6R 636	636	3	4		507321		146	
ZX-6R 636	636	5	12		507321		146	

				
Plaquettes arrière			Mâchoires arrière	
SEMI MÉTALLIQUES G1050	SEMI MÉTALLIQUES G1054	SINTERED G1380	N° Schéma	G2165
507128	507167		44	
507128	507167		44	
507128	507167		44	
	507205		175	
	507205		175	
	507205		175	
	507205		175	
	507205		175	
	507199		83	
	507199		83	
	507199		83	
	507221		33	
	507299		124	
	507299		124	
	507307		132	
	507307		132	
	507307		132	
	507317		142	
	507317		142	
	507317		142	
	507317		142	
	507317		142	
	507317		142	
	507317		142	
	507325		150	
	507325		150	
	507325		150	
	507325		150	
	507325		150	
	507325		150	
	507325		150	
	507325		150	
	507325		150	
	507353		165	
	507357		169	
	507357		169	
	507357		169	
	507357		169	

MOTEUR

CYCLE

PNEUMATIQUE

ATELIER

ACCESSOIRES

ÉLECTRICITÉ

FILTRATION

FREINAGE

TRANSMISSION

PLAQUETTES DE FREIN - MÂCHOIRES DE FREIN / BRAKE PADS - BRAKE SHOE

CGN
LE SENS DU DÉTAIL

MOTEUR

CYCLE

PNEUMATIQUE

ATELIER

ACCESSOIRES



ÉLECTRICITÉ

FILTRATION

FREINAGE

TRANSMISSION

Modèle	Cylindre	Depuis	Jusqu'à	GALFER MOTO			N° Schéma	Mâchoires avant G2165
				Plaquettes avant				
				SEMI MÉTALLIQUES G1050	SEMI MÉTALLIQUES G1054	SINTERED G1380		
ZX-6RR	600	3	4		507321		146	
ZX-6RR	600	5	6		507321		146	
NINJA 1000 SX	1000	21			507321		146	
Z 1000	1000	10	13		507321		146	
Z 1000	1000	14			507321		146	
Z 1000 ABS	1000	14			507321		146	
Z 1000 SX	1000	11			507321		146	
ZX 10R NINJA	1000	8	10		507321		146	
Z 1000	1000	3	6		507321		146	
ZX-9R NINJA	900	2			507321		146	
Z 1000 R EDITION	1000	17			507321		146	
ZX-6R	600	7	8		507321		146	
ZX-6R	600	9			507321		146	
ZZR 400	400	1			507321		146	
VN 1700 CLASSIC ABS	1700	12			507325		150	
VN 1700 CLASSIC NOMAD ABS	1700	12			507325		150	
VN 1700 CLASSIC TOURER ABS	1700	12			507325		150	
VN 1700 VOYAGER	1700	9			507325		150	
VN 1700 VOYAGER CUSTOM ABS	1700	11			507325		150	
VN 2000	2000	4			507325		150	
VN 1500 MEAN STREAK	1500	1			507325		150	
VN 1600 MEAN STREAK	1600	4	4		507325		150	
VN 1500 DRIFTER	1500	2			507325		150	
VN 800 DRIFTER	800	99			507325		150	
VN 900	900	7			507325		150	
VN 900 CLASIC	900	6			507325		150	
VN 900 CLASIC SPECIAL EDITION	900	11			507325		150	
VN-EASSIC Fi	1500	0			507325		150	
ZR-7 S IZQ/LEFT	750	99	4		507325		150	
ZR-7 S IZQ/LEFT	750	5			507325		150	
VN 1600 NOMAD RIGHT/DER	1600	5			507325		150	
VN 1600 SUMO/CLASSIC RIGHT/DER	1600	3			507325		150	
VN 1700 CLASSIC RIGHT/DER	1700	9			507325		150	
VN 1700 CLASSIC TOURER RIGHT/DER	1700	9			507325		150	
VN-TOURER RIGHT/DER	1500	3			507325		150	
VN 1600 MEAN STREAK	1600	5			507325		150	
NINJA H2 SX	1000	18		507107	507246	507158	102	
NINJA H2 SXE	1000	18		507107	507246	507158	102	
Z H2	1000	20		507107	507246	507158	102	
NINJA H2 SX SE	1000	20		507107	507246	507158	102	
NINJA H2 (200cv)	1000	15		507116	507252	507164	14	
NINJA H2 R (310cv)	1000	15		507116	507252	507164	14	

 Plaquettes arrière			 Mâchoires arrière	
SEMI MÉTALLIQUES G1050	SEMI MÉTALLIQUES G1054	SINTERED G1380	N° Schéma	G2165
	507357		169	
	507357		169	
	507205		175	
	507205		175	
	507205		175	
	507205		175	
	507205		175	
	507205		175	
	507362		178	
	507362		178	
	507307		132	
	507307		132	
	507307		132	
	507307		132	
	507307		132	
	507307		132	
	507317		142	
	507317		142	
	507323		148	
	507323		148	
	507323		148	
	507323		148	
	507323		148	
	507323		148	
	507323		148	
	507323		148	
	507325		150	
	507325		150	
	507325		150	
	507325		150	
	507325		150	
	507357		169	
	507205		175	
	507205		175	
	507199		83	

MOTEUR

CYCLE

PNEUMATIQUE

ATELIER

ACCESSOIRES

ÉLECTRICITÉ

FILTRATION

FREINAGE

TRANSMISSION

PLAQUETTES DE FREIN - MÂCHOIRES DE FREIN / BRAKE PADS - BRAKE SHOE

MOTEUR

CYCLE

PNEUMATIQUE

ATELIER

ACCESSOIRES

ÉLECTRICITÉ

FILTRATION

FREINAGE

TRANSMISSION



Modèle	Cylindre	Depuis	Jusqu'à	Plaquettes avant			N° Schéma	Mâchoires avant G2165
				SEMI MÉTALLIQUES G1050	SEMI MÉTALLIQUES G1054	SINTERED G1380		
GTR 1400	1400	7	9		507349		163	
GTR 1400	1400	10			507349		163	
GTR 1400 GRAND TOUR	1400	10			507349		163	
ZG 1400 CONCOURS	1400	8			507349		163	
ZG 1400 CONCOURS ABS	1400	8	9		507349		163	
ZG 1400 CONCOURS ABS	1400	10			507349		163	
ZX 7 RR (ZX750PI)	750	96			507349		163	
ZX-14 R	1400	6			507349		163	
ZX-14 R ABS	1400	14			507349		163	
ZZR 1400	1400	6	11		507349		163	
ZZR 1400	1400	12			507349		163	
ZZR 1400 PERFORMANCE SPORT	1400	16			507349		163	
KLX 230	230	21			507356		168	
KLX 230 R	230	22			507356		168	
KLX 230 SE	230	22			507356		168	
KLX 300 R	300	21			507356		168	
KL 125 ENDURO	125	3			507356		168	
KLX 250 S	250	8			507356		168	
KLX 450 R	450	7			507356		168	
KX 250	250	4	5		507356		168	
KX 250	250	6	8		507356		168	
KX 250 F	250	4	5		507356		168	
KX 250 F	250	6	10		507356		168	
KX 250 F	250	11	14		507356		168	
KX 250 F	250	15	19		507356		168	
KX 250 F	250	20	20		507356		168	
KX 250 F	250	21			507356		168	
KX 250 X	250	21			507356		168	
KX 450 F	450	6	10		507356		168	
KX 450 F	450	11	14		507356		168	
KX 450 F	450	15	18		507356		168	
KX 450 F	450	19			507356		168	
KX 450 X	450	21			507356		168	
KXE 250 F	250	3			507356		168	
KXE 450 F	450	6			507356		168	
ZX-6R 636	636	13			507366		182	
ZX-6R 636 ABS	636	13			507366		182	
ZX 10R NINJA	1000	11	15		507366		182	
ZX 10R NINJA ABS	1000	11	15		507366		182	
ZX 10R NINJA ABS	1000	16			507366		182	
ZX 10R SE	1000	18			507366		182	
ZX 10RR NINJA ABS	1000	17			507366		182	

PLAQUETTES DE FREIN - MÂCHOIRES DE FREIN / BRAKE PADS - BRAKE SHOE

Modèle	Cylindre	Depuis	Jusqu'à	GALFER MOTO Plaquettes avant			N° Schéma	Mâchoires avant G2165
				SEMI MÉTALLIQUES G1050	SEMI MÉTALLIQUES G1054	SINTERED G1380		
EPSILON 250	250	3			507283	507188	81	
J 125	125	16		507146	507285	507176	64	
J 300	300	14		507146	507285	507176	64	
J 300 SE	300	14		507146	507285	507176	64	
Z 800e	800	13			507371		187	
Z 800	800	13			507371		187	
Z 800 ABS	800	13			507371		187	
Z 800e ABS	800	13			507371		187	
Z 900	900	17			507371		187	
Z 900 PERFORMANCE	900	22			507371		187	
Z 750 R	750	11			507371		187	
Z 750 R SE	750	12			507371		187	
AR 125 A1, A1A	125	82					8	507379
BN 125	125	5						
ELIMINATOR	125	98	99				8	507379
ELIMINATOR	125	0					8	507379
EPSILON 150	150	3						
ER-5	500	97	0					
ER-5	500	1						
GPZ 250	250	83	85					
GPZ 400 R	400	85						
GPZ 500 S	500	90	92					
GPZ 500 S (1 disc)	500	88						
GPZ 500 S (2 discs)	500	88						
KDX 200	200	85	85					
KDX 200 C1	200	86	88					
KH 125 K1	125	82					8	507379
KH 125 K1, K2	125	83					8	507379
KL 250 TR	250	4						
KL 600 A1, A1L	600	84	84					
KL 600 S	600	85	89					
KL 600/R	600	84					8	507379
KLR 250	250	84	87					
KLR 250 ENDURO	250	88						
KLR 570	570	85	91					
KLR 600S	600	90	92					
KLR 750	750	88						
KMX 125	125	85	87					
KR 250	250	84	84					
KX 125	125	84	84					
KX 125	125	85	87					
KX 250	250	85	86				8	507379



PLAQUETTES DE FREIN - MÂCHOIRES DE FREIN / BRAKE PADS - BRAKE SHOE

Modèle	Cylindre	Depuis	Jusqu'à	GALFER MOTO			GALFER MOTO	
				Plaquettes avant			Mâchoires avant	
				SEMI MÉTALLIQUES G1050	SEMI MÉTALLIQUES G1054	SINTERED G1380	N° Schéma	G2165
KX 305 GPZ	305	81						
KX 500	500	83	83				8	507379
KX 550 A	550	83						
KZ 200 AG	200	83					8	507379
KZ 500 F	500	83						
KZ 550 F, G1, GT, SPORT	550	83	83					
KZR 500 A1	500	83						
RG 400 GAMMA	400	85						
TR 250	250	5						
VN 250 ELIMINATOR	250	99						
VN 800 CLASSIC	800	98						
W 650	650	99						
W 800	800	11	18					
ZL 600 ELIMINATOR	600	95						
ZR 400 F, A1	400	83	88					
ER-6 F / NINJA 650 R (USA) LEFT / IZQ	650	5						
ER-6 F / NINJA 650 R (USA) LEFT / IZQ ABS	650	6						
ER-6 N LEFT / IZQ	650	5						
ER-6 N LEFT / IZQ ABS	650	6						
GPZ 1100 (ZX1100E1) LEFT/IZQ	1100	95						
KLV 1000 LEFT/IZQ	1000	4						
VERSYS 650 LEFT / IZQ	650	6	14					
VERSYS 650 LEFT / IZQ ABS	650	6	14					
VN 1600 NOMAD LEFT/IZQ	1600	5						
VN 1600 SUMO/CLASSIC LEFT/IZQ	1600	3						
VN 1700 CLASSIC LEFT/IZQ	1700	9						
VN 1700 CLASSIC TOURER LEFT/IZQ	1700	9						
VN-CLASSIC TOURER LEFT/IZQ	1500	98	99					
VN-TOURER LEFT/IZQ	1500	3						
Z 750 LEFT/IZQ	750	4	6					
Z 750 S LEFT/IZQ	750	5	6					
ZEPHYR 1100 LEFT/IZQ	1100	96						
ZR-7 S DER,/RIGHT	750	99	4					
ZR-7 S DER,/RIGHT	750	5						
KAWASAKI 3 WHEELS								
KXT 250 A2/B1 TECATE	250	85	86	507081	507216		23	
KXT 250 B2 TECATE	250	87						
KXT 250 A1 TECATE	250	84		507085	507222	507152	25	
KLT 160 A1	160	85					8	507379
KLT 185 A1-2	185	86	87				8	507379

 Plaquettes arrière			 Mâchoires arrière	
SEMI MÉTALLIQUES G1050	SEMI MÉTALLIQUES G1054	SINTERED G1380	N° Schéma	G2165
507081	507216		23	
507081	507216		23	
507081	507216		23	
507081	507216		23	
507081	507216		23	
507081	507216		23	
507081	507216		23	
	507309		134	
	507325		150	
	507323		148	
	507323		148	
	507325		150	
	507325		150	
	507299		124	
507081	507216		23	
	507323		148	
	507323		148	
	507323		148	
	507323		148	
	507323		148	
	507323		148	
	507323		148	
	507323		148	
	507323		148	
	507323		148	
	507323		148	
	507323		148	
	507323		148	
	507323		148	
	507323		148	
	507323		148	
	507323		148	
	507323		148	
	507323		148	
	507325		150	
	507325		150	
507081	507216		23	
507081	507216		23	



PLAQUETTES DE FREIN - MÂCHOIRES DE FREIN / BRAKE PADS - BRAKE SHOE

Modèle	Cylindre	Depuis	Jusqu'à	GALFER MOTO			N° Schéma	Mâchoires avant G2165
				Plaquettes avant				
				SEMI MÉTALLIQUES G1050	SEMI MÉTALLIQUES G1054	SINTERED G1380		
KAWASAKI 4 WHEELS								
KAF MULE PRO (ALL) LEFT/IZQ.	820	16						
KAF MULE PRO (ALL) LEFT/IZQ.	1000	16						
KEF 300 LAKOTA	300	95	0		507295		120	
KEF 300 LAKOTA SPORT	300	95	0		507295		120	
KSF 250 A1-> A7 MOJAVE	250	87	93		507295		120	
KSF 250 MOJAVE	250	88			507295		120	
KXF 250 A1,A2 TECATE	250	87	88		507295		120	
KFX 400	400	3			507295		120	
KFX 450 R RIGHT/DER.	450	7			507295		120	
KLF 300 C1-> C5 BAYOU RIGHT/DER.	300	89	1	507088	507225		31	
KLF 400 B1 BAYOU RIGHT/DER.	400	93	99	507088	507225		31	
KVF 300	300	13			507363		179	
KFX 750 BRUTE FORCE 4X4 IZQ.	750	4						
KLF 300 B1-> B6 BAYOU	300	88	1					
KRF 750 (TODOS) DER.	750	8						
KRF 750 (TODOS) IZQ.	750	8						
KVF 300	300	99	3					
KVF 400 PRAIRIE	400	97						
KVF 750 DER.	750	8						
KVF 750 IZQ.	750	8						
KAF MULE PRO (ALL) RIGHT/DER.	820	16						
KAF MULE PRO (ALL) RIGHT/DER.	1000	16						
KLF 300 C1-> C5 BAYOU LEFT/IZQ.	300	89	1					
KLF 400 B1 BAYOU LEFT/IZQ.	400	93	99					
KFX 750 BRUTE FORCE 4X4 DER.	750	4						
KAWASAKI COLOMBIA								
VICTOR M 150	150							
VICTOR S 150	150							
WIND 125	125							
ZX 130 MAGIC II	130							
KAWASAKI INDONESIA								
D-TRACKER 250	250	11			507300		125	
D-TRACKER 150	150	12		507086	507223		9	
KLX 150 S	150	9			507310		135	
ATHLETE	125	12		507088	507225		31	
NINJA R	150	10		507088	507225		31	
NINJA RR	150	10		507088	507225		31	
NINJA SPECIAL EDITION	150	10		507088	507225		31	
NINJA SS	150	10		507088	507225		31	
ZX 130 VR	130	12						

				
Plaquettes arrière			Mâchoires arrière	
SEMI MÉTALLIQUES G1050	SEMI MÉTALLIQUES G1054	SINTERED G1380	N° Schéma	G2165
507088	507225		31	
507088	507225		31	
507081	507216		23	
507081	507216		23	
507081	507216		23	
507081	507216		23	
507081	507216		23	
	507295		120	
507088	507225		31	
507088	507225		31	
	507363		179	
	507221		33	
507081	507216		23	
507088	507225		31	
	507221		33	
507086	507223		9	
507086	507223		9	
507088	507225		31	
	507221		33	
	507221		33	
	507221		33	
	507221		33	
	507221		33	
507088	507225		31	
507088	507225		31	
507088	507225		31	
507143	507230	507154	48	
507088	507225		31	
	507221		33	
	507221		33	
	507221		33	
507088	507225		31	
507088	507225		31	
507088	507225		31	
507088	507225		31	
507088	507225		31	
507088	507225		31	

PLAQUETTES DE FREIN - MÂCHOIRES DE FREIN / BRAKE PADS - BRAKE SHOE

Modèle	Cylindre	Depuis	Jusqu'à	GALFER MOTO Plaquettes avant			N° Schéma	GALFER MOTO Mâchoires avant G2165
				SEMI MÉTALLIQUES G1050	SEMI MÉTALLIQUES G1054	SINTERED G1380		
KAWASAKI MALASIA								
D-TRACKER 250	250	11			507300		125	
D-TRACKER 150	150	12		507086	507223		9	
KLX 140 L	140	9			507310		135	
KLX 150 S	150	9			507310		135	
NINJA KRR ZX 150	150	8		507088	507225		31	
Z 250	250	13		507088	507225		31	
KEEWAY								
TX 125	125	10		507075	507210		4	
CRUISER 250	250	10		507079	507214		38	
SPEED 150	150	9		507079	507214		38	
RKS 125	125	22			507305		130	
SILVER BLADE 250 (LEFT/DER)	250	13			507234	507180	90	
VIVA II 125	125	5		507083	507244		19	
VIVA II 150	150	5		507083	507244		19	
VIVA 125	125	5		507083	507244		19	
OUTLOOK 125	125	10		507107	507246	507158	102	
OUTLOOK 150	150	10		507107	507246	507158	102	
OUTLOOK 125	125	7	8	507107	507246	507158	102	
OUTLOOK 150	150	7	8	507107	507246	507158	102	
SILVER BLADE 125	125	7		507115	507251	507163	66	
SILVER BLADE 150	150	7		507115	507251	507163	66	
SILVER BLADE 250	250	7	12	507115	507251	507163	66	
SPEED 125	125	7		507124	507260		24	
K2 125	125	7		507131	507268	507170	35	
K2 150	150	7		507131	507268	507170	35	
K2 250	250	7		507131	507268	507170	35	
ARN 125	125	5						
ARSEN 150	150	10						
F ACT 125 / RACING	125	8						
FOCUS 125	125	7						
HACKER 125	125	8						
KW 125	125	10						
KW 150	150	10						
MATRIX 125	125	6	6					
MATRIX 125	125	7						
SUPERLIGHT 125	125	7						
SILVER BLADE 250 (RIGHT/IZQ)	250	13						
KEEWAY 4 WHEELS								
DRAGON 250	250	8		507086	507223		9	
KEEWAY BENDA								
DARK FLAG	500	22		507116	507252	507164	14	

				
Plaquettes arrière			Mâchoires arrière	
SEMI MÉTALLIQUES G1050	SEMI MÉTALLIQUES G1054	SINTERED G1380	N° Schéma	G2165
	507221		33	
	507221		33	
	507221		33	
	507221		33	
507088	507225		31	
507088	507225		31	
		507181	37	
	507221		33	
507124	507260		24	
	507369		185	
	507234	507180	90	
	507221		33	
	507221		33	
507083	507244		19	
	507221		33	
	507221		33	
507107	507246	507158	102	
507107	507246	507158	102	
507143	507230	507154	48	
507143	507230	507154	48	
507143	507230	507154	48	
507124	507260		24	
507131	507268	507170	35	
507131	507268	507170	35	
507131	507268	507170	35	
507102	507239	507156	3	
507124	507260		24	
507083	507244		19	
507085	507222	507152	25	
507074	507202		2	
507124	507260		24	
507124	507260		24	
507085	507222	507152	25	
507083	507244		19	
507107	507246	507158	102	
507107	507246	507158	102	
507085	507222	507152	25	
	507199		83	

PLAQUETTES DE FREIN - MÂCHOIRES DE FREIN / BRAKE PADS - BRAKE SHOE

CGN
LE SENS DU DÉTAIL

MOTEUR

CYCLE

PNEUMATIQUE

ATELIER

ACCESSOIRES



ÉLECTRICITÉ

FILTRATION

FREINAGE

TRANSMISSION

Modèle	Cylindre	Depuis	Jusqu'à	GALFER MOTO			N° Schéma	Mâchoires avant G2165
				Plaquettes avant				
				SEMI MÉTALLIQUES G1050	SEMI MÉTALLIQUES G1054	SINTERED G1380		
LFC 700	700	22		507116	507252	507164	14	
LFS 700	700	22		507116	507252	507164	14	
ROCK 300	300	22		507120	507256	507166	7	
V 302 C	300	22		507120	507256	507166	7	
KEEWAY MBP								
SC 125 RE	125	22		507081	507216		23	
T 125	125	22		507086	507223		9	
T 125 X	125	22		507086	507223		9	
C 650 V	650	22			507305		130	
F125	125	22			507305		130	
NR 125	125	22			507305		130	
NR125 X	125	22			507305		130	
C 1002 V	1000	22		507143	507230	507154	48	
T 1002 V	1000	22		507143	507230	507154	48	
SC 125 LX	125	22			507234	507180	90	
SC 125	125	22			507234	507180	90	
M 502	500	22			507320		145	
KRAMIT								
ER 125 RV3	125	88		507081	507216		23	
ER 250 RV3	250	88		507081	507216		23	
ER 300 RV3	300	88		507081	507216		23	
KREIDLER								
ENDURO 125 DD	125	8		507086	507223		9	
SUPERMOTO 125 DD	125	8		507086	507223		9	
SUPERMOTO 250 DD	250	8		507086	507223		9	
NAKED 125 DD LEFT/IZQ.	125	8			507305		130	
G 125 FLORETT	125	8						
NAKED 125 DD RIGHT/DER.	125	8						
KTM								
125 XC	125	86		507074	507202		2	
250 XC	250	86		507074	507202		2	
300 GS, XC	300	86	90	507074	507202		2	
550 XC	550	86		507074	507202		2	
600 BAJA	600	86	86	507074	507202		2	
125 ENDURO	125	88	91	507080	507215		88	
125 GS	125	89	90	507080	507215		88	
125 MX	125	88	88	507080	507215		88	
250 ENDURO	250	88	91	507080	507215		88	
250 GS	250	89	90	507080	507215		88	
350 ENDURO	350	88		507080	507215		88	
500 GS	500	89		507080	507215		88	
500 MX	500	88	88	507080	507215		88	

 Plaquettes arrière			 Mâchoires arrière	
SEMI MÉTALLIQUES G1050	SEMI MÉTALLIQUES G1054	SINTERED G1380	N° Schéma	G2165
	507199		83	
	507199		83	
	507335		156	
	507335		156	
507107	507246	507158	102	
507107	507246	507158	102	
507107	507246	507158	102	
507128	507167		44	
	507369		185	
	507369		185	
	507369		185	
	507324		149	
	507324		149	
507107	507246	507158	102	
		519664	193	
507128	507167		44	
	507298		123	
	507298		123	
	507298		123	
	507221		33	
	507221		33	
	507221		33	
507088	507225		31	
507086	507223		9	
	507221		33	
507074	507202		2	
507074	507202		2	
507074	507202		2	
507074	507202		2	
507074	507202		2	
507080	507215		88	
507080	507215		88	
507080	507215		88	
507080	507215		88	
507080	507215		88	
507080	507215		88	
507080	507215		88	
507080	507215		88	
507080	507215		88	

PLAQUETTES DE FREIN - MÂCHOIRES DE FREIN / BRAKE PADS - BRAKE SHOE

MOTEUR

CYCLE

PNEUMATIQUE

ATELIER

ACCESSOIRES



ÉLECTRICITÉ

FILTRATION

FREINAGE

TRANSMISSION

Modèle	Cylindre	Depuis	Jusqu'à	GALFER MOTO Plaquettes avant			N° Schéma	GALFER MOTO Mâchoires avant G2165
				SEMI MÉTALLIQUES G1050	SEMI MÉTALLIQUES G1054	SINTERED G1380		
600 ENDURO LC4, INCAS	600	88		507080	507215		88	
125 MX	125	89	91	507081	507216		23	
250 MX	250	89	91	507081	507216		23	
350 MX	350	91	91	507081	507216		23	
500 MX	500	89	91	507081	507216		23	
600 MX LC4	600	90		507081	507216		23	
125 ENDURO	125	93		507081	507216		23	
125 GS	125	93	93	507081	507216		23	
125 MX	125	92	95	507081	507216		23	
125 SX	125	93	93	507081	507216		23	
250 ENDURO	250	93		507081	507216		23	
250 GS	250	93	93	507081	507216		23	
250 MX	250	92	92	507081	507216		23	
250 SX, EGS, EXC	250	93	93	507081	507216		23	
300 ENDURO	300	93		507081	507216		23	
300 SX, EGS, EXC	300	93	3	507081	507216		23	
350 MX	350	92		507081	507216		23	
500 MX	500	92		507081	507216		23	
500 SX	500	93		507081	507216		23	
600 4T GS	600	93	93	507081	507216		23	
125 ENDURO	125	92	92	507081	507216		23	
125 GS	125	91	92	507081	507216		23	
250 ENDURO	250	92	92	507081	507216		23	
250 GS	250	91	92	507081	507216		23	
300 ENDURO	300	92	92	507081	507216		23	
300 GS	300	91		507081	507216		23	
600 4T GARA	600	91	92	507081	507216		23	
125 VC	125	87		507084	507220		91	
125 WMX	125	88		507084	507220		91	
250 VC	250	87		507084	507220		91	
250 WMX	250	88		507084	507220		91	
350 WMX	350	88		507084	507220		91	
400 ENDURO	400	87		507084	507220		91	
500 MX	500	87	87	507084	507220		91	
500 WMX	500	88		507084	507220		91	
550 MX LC 4	550	87		507084	507220		91	
600 BAJA	600	87		507084	507220		91	
600 ER LCH	600	88		507084	507220		91	
600 PROLEVER	600	87		507084	507220		91	
950 ADVENTURE S	950	3		507143	507230	507154	48	
950 R SUPER ENDURO	950	6		507143	507230	507154	48	
990 ADVENTURE / S	990	6		507143	507230	507154	48	

 Plaquettes arrière			 Mâchoires arrière	
SEMI MÉTALLIQUES G1050	SEMI MÉTALLIQUES G1054	SINTERED G1380	N° Schéma	G2165
507080	507215		88	
507081	507216		23	
507081	507216		23	
507081	507216		23	
507081	507216		23	
507081	507216		23	
507143	507230	507154	48	
507143	507230	507154	48	
507143	507230	507154	48	
507143	507230	507154	48	
507143	507230	507154	48	
507143	507230	507154	48	
507143	507230	507154	48	
507143	507230	507154	48	
507143	507230	507154	48	
507143	507230	507154	48	
507143	507230	507154	48	
507143	507230	507154	48	
507143	507230	507154	48	
507143	507230	507154	48	
507143	507230	507154	48	
507143	507230	507154	48	
507143	507230	507154	48	
507143	507230	507154	48	
507084	507220		91	
507084	507220		91	
507084	507220		91	
507084	507220		91	
507084	507220		91	
507084	507220		91	
507084	507220		91	
507084	507220		91	
507084	507220		91	
507084	507220		91	
507084	507220		91	
507084	507220		91	
	507322		147	
	507322		147	
	507322		147	

MOTEUR

CYCLE

PNEUMATIQUE

ATELIER

ACCESSOIRES

ÉLECTRICITÉ

FILTRATION

FREINAGE

TRANSMISSION

PLAQUETTES DE FREIN - MÂCHOIRES DE FREIN / BRAKE PADS - BRAKE SHOE

CGN
LE SENS DU DÉTAIL

MOTEUR

CYCLE

PNEUMATIQUE

ATELIER

ACCESSOIRES

ÉLECTRICITÉ

FILTRATION



FREINAGE

TRANSMISSION

Modèle	Cylindre	Depuis	Jusqu'à	GALFER MOTO			N° Schéma	Mâchoires avant G2165
				SEMI MÉTALLIQUES G1050	SEMI MÉTALLIQUES G1054	SINTERED G1380		
990 ADVENTURE / S ABS	990	6		507143	507230	507154	48	
990 ADVENTURE R	990	9		507143	507230	507154	48	
990 R SUPER ENDURO	990	6		507143	507230	507154	48	
1050 ADVENTURE	1050	15		507143	507230	507154	48	
1090 ADVENTURE	1090	17		507143	507230	507154	48	
1190 ADVENTURE	1190	13		507143	507230	507154	48	
1190 ADVENTURE R	1190	13		507143	507230	507154	48	
1290 SUPER ADVENTURE	1290	15		507143	507230	507154	48	
1290 SUPER ADVENTURE R	1290	17		507143	507230	507154	48	
1290 SUPER ADVENTURE S	1290	17		507143	507230	507154	48	
1290 SUPER ADVENTURE T	1290	17		507143	507230	507154	48	
790 ADVENTURE	790	19		507143	507230	507154	48	
790 ADVENTURE R / RALLY	790	20		507143	507230	507154	48	
890 ADVENTURE	890	21		507143	507230	507154	48	
890 ADVENTURE L	890	22		507143	507230	507154	48	
890 ADVENTURE R / RALLY	890	21		507143	507230	507154	48	
950 SUPERMOTO	950	5		507143	507230	507154	48	
950 SUPERMOTO R	950	7		507143	507230	507154	48	
990 SM T	990	9		507143	507230	507154	48	
990 SM T ABS	990	11		507143	507230	507154	48	
990 SUPERMOTO / R	990	7	11	507143	507230	507154	48	
990 SM R	990	9		507143	507230	507154	48	
990 SUPERMOTO / R	990	12		507143	507230	507154	48	
620 DUKE	620	95	2		507320		145	
640 LC4 SUPERMOTARD	640	2	4		507320		145	
660 SMC SUPERMOTARD	660	99			507320		145	
125 EXC/EGS/SX	125	95	3		507320		145	
125 GS	125	94	94		507320		145	
125 SX	125	94	3		507320		145	
200 EGS	200	99	2		507320		145	
200 EXC	200	98	3		507320		145	
200 SX	200	3	3		507320		145	
250 EGS	250	99			507320		145	
250 EXC / 4T	250	3	3		507320		145	
250 EXC/EGS/SX	250	94	2		507320		145	
250 GS	250	94			507320		145	
250 MX	250	3			507320		145	
250 SX	250	94	2		507320		145	
300 EXC	300	3	3		507320		145	
350 LC4 EXC	350	94			507320		145	
400 LC4 EGS	400	94	95		507320		145	
400 LC4 EGS	400	96			507320		145	

PLAQUETTES DE FREIN - MÂCHOIRES DE FREIN / BRAKE PADS - BRAKE SHOE

Modèle	Cylindre	Depuis	Jusqu'à	GALFER MOTO			N° Schéma	Mâchoires avant G2165
				Plaquettes avant				
				SEMI MÉTALLIQUES G1050	SEMI MÉTALLIQUES G1054	SINTERED G1380		
440 SX	440	94			507320		145	
450 EXC	450	3	3		507320		145	
525 EXC	525	3	3		507320		145	
525 SX	525	3	3		507320		145	
540 SXC	540	99			507320		145	
550 MG,XC	550	94			507320		145	
600 4T GS	600	94			507320		145	
620 LC4 EXC, EGS, SX	620	94			507320		145	
625 EXC	625	3			507320		145	
640 LC4 ADVENTURE R	640	99	5		507320		145	
640 LC4 ADVENTURE R	640	6			507320		145	
640 LC4 ENDURO	640	99			507320		145	
450 RALLY	450	19			507320		145	
690 ENDURO	690	8			507320		145	
690 ENDURO R	690	9	13		507320		145	
690 ENDURO R ABS	690	14	18		507320		145	
690 ENDURO R ABS	690	19			507320		145	
625 SMC	625	6			507320		145	
640 DUKE	640	99			507320		145	
640 LC4 SUPERMOTARD (DF606SM)	640	5			507320		145	
660 SMC SUPERMOTARD	660	99			507320		145	
690 DUKE	690	12			507320		145	
690 SM	690	7			507320		145	
790 DUKE	790	18			507320		145	
690 DUKE	690	8	11		507320		145	
690 DUKE III R	690	10			507320		145	
690 SM /PRESTIGE	690	7			507320		145	
690 SMC	690	8			507320		145	
690 SMC R	690	13			507320		145	
690 SMC R ABS	690	13	15		507320		145	
690 SMC R ABS	690	16	20		507320		145	
690 SMR	690	7			507320		145	
950 DUKE LC8	950	3			507320		145	
950 SUPER DUKE	950	5			507320		145	
990 SUPER DUKE	990	6			507320		145	
125 DUKE	125	11			507320		145	
125 DUKE ABS	125	14			507320		145	
200 DUKE	200	12			507320		145	
200 DUKE ABS	200	13	23		507320		145	
250 ADVENTURE	250	21			507320		145	
250 DUKE	250	16	21		507320		145	
390 ADVENTURE CAST WHEELS	390	20			507320		145	

 Plaquettes arrière			 Mâchoires arrière	
SEMI MÉTALLIQUES G1050	SEMI MÉTALLIQUES G1054	SINTERED G1380	N° Schéma	G2165
507143	507230	507154	48	
507143	507230	507154	48	
507143	507230	507154	48	
507143	507230	507154	48	
507143	507230	507154	48	
507143	507230	507154	48	
507143	507230	507154	48	
507143	507230	507154	48	
507143	507230	507154	48	
507143	507230	507154	48	
507143	507230	507154	48	
	507322		147	
	507322		147	
	507322		147	
	507322		147	
	507322		147	
	507324		149	
	507324		149	
	507324		149	
	507324		149	
	507324		149	
	507324		149	
	507324		149	
	507324		149	
	507324		149	
	507324		149	
	507347		161	
	507347		161	
	507347		161	
	507347		161	
	507347		161	
	507347		161	
	507347		161	
	507347		161	
	507347		161	
	507347		161	
	507370		186	
	507370		186	
	507370		186	
	507370		186	
	507370		186	
	507370		186	
	507370		186	

MOTEUR

CYCLE

PNEUMATIQUE

ATELIER

ACCESSOIRES

ÉLECTRICITÉ

FILTRATION

FREINAGE

TRANSMISSION

PLAQUETTES DE FREIN - MÂCHOIRES DE FREIN / BRAKE PADS - BRAKE SHOE

CGN
LE SENS DU DÉTAIL

MOTEUR

CYCLE

PNEUMATIQUE

ATELIER

ACCESSOIRES

ÉLECTRICITÉ

FILTRATION

FREINAGE

TRANSMISSION

Modèle	Cylindre	Depuis	Jusqu'à	GALFER MOTO			N° Schéma	Mâchoires avant G2165
				Plaquettes avant				
				SEMI MÉTALLIQUES G1050	SEMI MÉTALLIQUES G1054	SINTERED G1380		
390 ADVENTURE SPOKE WHEELS	390	23			507320		145	
390 DUKE ABS	390	13	16		507320		145	
390 DUKE ABS	390	17	22		507320		145	
RC 125	125	14	14		507320		145	
RC 125	125	22	23		507320		145	
RC 125 ABS	125	15	21		507320		145	
RC 200	200	14	21		507320		145	
RC 390	390	14	16		507320		145	
RC 390	390	17	21		507320		145	
RC 390	390	22	23		507320		145	
690 SMC R ABS	690	21			507320		145	
690 DUKE R	690	13	16		507320		145	
890 DUKE GP	890	22			507320		145	
890 DUKE L	890	22			507320		145	
890 DUKE R	890	20			507320		145	
1290 SUPER DUKE GT	1290	16		507116	507252	507164	14	
1290 SUPER DUKE R	1290	13		507116	507252	507164	14	
1290 SUPER DUKE R EVO	1290	22		507116	507252	507164	14	
1290 SUPER DUKE RR	1290	21	22	507116	507252	507164	14	
BRABUS 1300 R	1300	22		507116	507252	507164	14	
RC 8	1190	8		507116	507252	507164	14	
RC 8 R	1190	9		507116	507252	507164	14	
RC 8C 890	890	22	22	507116	507252	507164	14	
RC 8C 890	890	23	23	507116	507252	507164	14	
SX-E	EL	20			507344		158	
SX-E5	EL	21			507344		158	
125 EXC	125	4			507358		170	
125 SX	125	4			507358		170	
125 XC-W	125	19			507358		170	
144 SX	144	8			507358		170	
150 EXC TPI	150	21			507358		170	
150 SX	150	19			507358		170	
150 XC	150	10			507358		170	
150 XC-W	150	19			507358		170	
200 EXC	200	4			507358		170	
200 SX	200	4			507358		170	
250 F	250	6			507358		170	
250 EXC - TPI / SIX DAYS	250	19			507358		170	
250 EXC / 4T	250	4			507358		170	
250 EXC F	250	15			507358		170	
250 SX	250	3			507358		170	
250 SX F	250	15			507358		170	

PLAQUETTES DE FREIN - MÂCHOIRES DE FREIN / BRAKE PADS - BRAKE SHOE

MOTEUR

CYCLE

PNEUMATIQUE

ATELIER

ACCESSOIRES

ÉLECTRICITÉ

FILTRATION

FREINAGE

TRANSMISSION

Modèle	Cylindre	Depuis	Jusqu'à	GALFER MOTO			N° Schéma	Mâchoires avant G2165
				Plaquettes avant				
				SEMI MÉTALLIQUES G1050	SEMI MÉTALLIQUES G1054	SINTERED G1380		
250 XC / F / W	250	6			507358		170	
300 EXC	300	4			507358		170	
300 EXC - E	300	8			507358		170	
300 EXC - F / SIX DAYS	300	19			507358		170	
300 EXC - TPI / SIX DAYS	300	19			507358		170	
300 MXC	300	4			507358		170	
300 XC / W	300	6			507358		170	
350 EXC F	350	12			507358		170	
350 SX F	350	11			507358		170	
350 SX FACTORY	350	10			507358		170	
350 XC F	350	11			507358		170	
400 EXC	400	4			507358		170	
450 EXC	450	4			507358		170	
450 EXC - F / SIX DAYS	450	19			507358		170	
450 EXC - R	450	8			507358		170	
450 MXC	450	4			507358		170	
450 RALLY	450	11	18		507358		170	
450 SX	450	3			507358		170	
450 SXF	450	7			507358		170	
450 XC	450	6			507358		170	
450 XC SIX DAYS	450	10			507358		170	
500 EXC	500	14			507358		170	
500 EXC - F / SIX DAYS	500	19			507358		170	
505 SX	505	7			507358		170	
525 EXC	525	4			507358		170	
525 MXC	525	4			507358		170	
525 SX	525	4			507358		170	
530 EXC - R	530	8			507358		170	
530 XC / W	530	8			507358		170	
530 XC SIX DAYS	530	10			507358		170	
450 SMR	450	7	20		507358		170	
560 SMR	560	7			507358		170	
450 SMR	450	21			507358		170	
125 MX	125	86	87					
125 RS	125	89						
350 GS4, K4, XC, MC	350	83						
390 XC, MC	390	83						
420 XC, MC	420	83						
500 K4	500	83						
500 MX	500	86	86					
500 XC, MC	500	83						
600 4T, GS, A/E	600	87	90					

PLAQUETTES DE FREIN - MÂCHOIRES DE FREIN / BRAKE PADS - BRAKE SHOE

CGN
LE SENS DU DÉTAIL

MOTEUR

CYCLE

PNEUMATIQUE

ATELIER

ACCESSOIRES



ÉLECTRICITÉ

FILTRATION

FREINAGE

TRANSMISSION

Modèle	Cylindre	Depuis	Jusqu'à	GALFER MOTO			N° Schéma	Mâchoires avant G2165
				SEMI MÉTALLIQUES G1050	SEMI MÉTALLIQUES G1054	SINTERED G1380		
KYMCO								
NEXXON 125	125	9		507079	507214		38	
AGILITY CITY 125	125	9	17	507081	507216		23	
NEXXON 125	125	7	8		507234	507180	90	
STRAIGHT 125	125	7			507234	507180	90	
JETIX	125	10			507234	507180	90	
JETIX	150	10			507234	507180	90	
BET & WIN 125	125	0			507234	507180	90	
BET & WIN 150	150	0			507234	507180	90	
BET & WIN 250	250	0			507234	507180	90	
DINK 125	125	97			507234	507180	90	
DINK 150	150	97			507234	507180	90	
GRAND DINK 125	125	2			507234	507180	90	
GRAND DINK 250	250	1	1		507234	507180	90	
NSR 150	150	94			507234	507180	90	
QUANNON 125	125	7			507234	507180	90	
QUANNON 150	150	10			507234	507180	90	
QUANNON NAKED 125	125	9			507234	507180	90	
SPIKE	125	4			507234	507180	90	
STRAIGHT 150	150	5			507234	507180	90	
YAGER 125	125	7	8		507234	507180	90	
YAGER GT 125	125	9	12		507234	507180	90	
YAGER GT 200 i	200	9			507234	507180	90	
YUP 250	250	2			507234	507180	90	
LIKE	125	9	16		507234	507180	90	
LIKE	200	9			507234	507180	90	
LIKE i	150	20	21		507234	507180	90	
AGILITY CARRY 125	125	19			507234	507180	90	
AGILITY CITY 125	125	18			507234	507180	90	
PEOPLE 300 LEFT/IZQ.	300	8		507115	507251	507163	66	
SUPER 9	125	0		507126	507264		26	
SUPER 9	250	0		507126	507264		26	
MYROAD 700	700	8		507128	507167		44	
XCITING 250 R	250	8		507128	507167		44	
XCITING 500	500	4		507128	507167		44	
XCITING 400	400	12		507128	507167		44	
XCITING 400 S	400	18		507128	507167		44	
XCITING 400 TCS	400	22		507128	507167		44	
GRAND DINK 250	250	2			507354		166	
K - XCT 300i	300	12		507145	507282	507187	111	
PEOPLE GT 300i	300	10		507145	507282	507187	111	
PEOPLE GT1 125	125	10	11	507145	507282	507187	111	

				
Plaquettes arrière			Mâchoires arrière	
SEMI MÉTALLIQUES G1050	SEMI MÉTALLIQUES G1054	SINTERED G1380	N° Schéma	G2165
507079	507214		38	
507126	507264		26	
507076	507211		86	
507076	507211		86	
507079	507214		38	
507079	507214		38	
	507234	507180	90	
	507234	507180	90	
	507234	507180	90	
	507234	507180	90	
	507234	507180	90	
	507234	507180	90	
	507234	507180	90	
	507234	507180	90	
	507234	507180	90	
	507234	507180	90	
	507234	507180	90	
	507234	507180	90	
	507234	507180	90	
	507234	507180	90	
	507234	507180	90	
	507234	507180	90	
	507234	507180	90	
507107	507246	507158	102	
507107	507246	507158	102	
507126	507264		26	
507147	507286	507177	59	
507147	507286	507177	59	
507107	507246	507158	102	
	507234	507180	90	
	507234	507180	90	
507128	507167		44	
507128	507167		44	
507128	507167		44	
	507368		184	
	507368		184	
	507368		184	
507130	507267	507169	78	
507123	507259	507183	50	
507123	507259	507183	50	
507123	507259	507183	50	

MOTEUR

CYCLE

PNEUMATIQUE

ATELIER

ACCESSOIRES

ÉLECTRICITÉ

FILTRATION

FREINAGE

TRANSMISSION

PLAQUETTES DE FREIN - MÂCHOIRES DE FREIN / BRAKE PADS - BRAKE SHOE

CGN
LE SENS DU DÉTAIL

MOTEUR

CYCLE

PNEUMATIQUE

ATELIER

ACCESSOIRES



ÉLECTRICITÉ

FILTRATION

FREINAGE

TRANSMISSION

Modèle	Cylindre	Depuis	Jusqu'à	GALFER MOTO			N° Schéma	Mâchoires avant G2165
				Plaquettes avant				
				SEMI MÉTALLIQUES G1050	SEMI MÉTALLIQUES G1054	SINTERED G1380		
GS 125i	125	10		507145	507282	507187	111	
PEOPLE	125	17		507146	507285	507176	64	
PEOPLE S	150	17		507146	507285	507176	64	
PEOPLE S ABS	125	19		507146	507285	507176	64	
AGILITY MAXI	300	15		507146	507285	507176	64	
DINK 125 X	125	22		507146	507285	507176	64	
DOWNTOWN	125	15		507146	507285	507176	64	
NEW DOWNTOWN	125	16		507146	507285	507176	64	
PEOPLE GTI	200	12		507146	507285	507176	64	
PEOPLE GTI 125	125	12	11	507146	507285	507176	64	
X TOWN	125	16		507146	507285	507176	64	
X TOWN	300	16		507146	507285	507176	64	
DOWNTOWN	125	9	14	507146	507285	507176	64	
DOWNTOWN	200	10		507146	507285	507176	64	
DOWNTOWN	300	9	14	507146	507285	507176	64	
SUPER DINK 300	300	10		507146	507285	507176	64	
SUPER DINK 300 i ABS	300	11		507146	507285	507176	64	
YAGER GT 125	125	13		507146	507285	507176	64	
YAGER GT 300 i	300	13		507146	507285	507176	64	
AGILITY 300	300	19		507146	507285	507176	64	
LIKE	125	17		507146	507285	507176	64	
LIKE	150	17	19	507146	507285	507176	64	
MILLER	125	19		507146	507285	507176	64	
DTX 125	125	22		507146	507285	507176	64	
DTX 350	350	22		507146	507285	507176	64	
SUPER DINK 125i	125	9	17	507146	507285	507176	64	
PEOPLE	250	5			507289	507192	82	
PEOPLE S IZQ./LEFT	250	6			507289	507192	82	
DOWNTOWN	350	15			507289	507192	82	
K-XCT	125	15			507289	507192	82	
K-XCT	125	13	14		507289	507192	82	
XCITING 250	250	5	5		507289	507192	82	
XCITING 250	250	6			507289	507192	82	
XCITING 300i	300	8			507289	507192	82	
XCITING 300i R	300	8			507289	507192	82	
SUPER DINK 125i	125	18			507289	507192	82	
CV3 RIGHT/DER	550	21						
AK 550	550	17						
AK 550 ST	550	22						
125 FREEWY	125	94						
ACTIV 125	125	4						
AGILITY 125	125	6	8				22	507393

				
Plaquettes arrière			Mâchoires arrière	
SEMI MÉTALLIQUES G1050	SEMI MÉTALLIQUES G1054	SINTERED G1380	N° Schéma	G2165
507145	507282	507187	111	
507107	507246	507158	102	
507107	507246	507158	102	
507107	507246	507158	102	
507123	507259	507183	50	
507123	507259	507183	50	
507123	507259	507183	50	
507123	507259	507183	50	
507123	507259	507183	50	
507123	507259	507183	50	
507123	507259	507183	50	
507123	507259	507183	50	
507128	507167		44	
507128	507167		44	
507128	507167		44	
507128	507167		44	
507128	507167		44	
507128	507167		44	
507128	507167		44	
507145	507282	507187	111	
507147	507286	507177	59	
507147	507286	507177	59	
507147	507286	507177	59	
		519663	192	
		519663	192	
	507234	507180	90	
507107	507246	507158	102	
507123	507259	507183	50	
507123	507259	507183	50	
507128	507167		44	
507128	507167		44	
507128	507167		44	
507128	507167		44	
507128	507167		44	
		519663	192	
507107	507246	507158	102	
	507199		83	
	507199		83	
507103	507241		100	
	507234	507180	90	
507107	507246	507158	102	

PLAQUETTES DE FREIN - MÂCHOIRES DE FREIN / BRAKE PADS - BRAKE SHOE

CGN
LE SENS DU DÉTAIL

MOTEUR

CYCLE

PNEUMATIQUE

ATELIER

ACCESSOIRES



ÉLECTRICITÉ

FILTRATION

FREINAGE

TRANSMISSION

Modèle	Cylindre	Depuis	Jusqu'à	GALFER MOTO Plaquettes avant			N° Schéma	GALFER MOTO Mâchoires avant G2165
				SEMI MÉTALLIQUES G1050	SEMI MÉTALLIQUES G1054	SINTERED G1380		
AGILITY RS 125	125	9					22	507393
CUSTOM DX 150	150	94						
HEROISM	150	94						
HEROISM	125	95					2	507373
HIPSER 125	125	0						
HIPSER 150	150	0						
K-PIPE	125	12						
MINI BIKE 150	150	14						
MOVIE	125	97	8				22	507393
MOVIE 125 S i	125	9					22	507393
MOVIE XL 150	150	1					22	507393
PEOPLE	250	2	4					
PEOPLE	125	99	16				22	507393
PEOPLE	150	99	4				22	507393
PEOPLE	200	5					22	507393
STRAIGHT 125	125	5	6					
STRYKER 125	125	99						
SUPER 8	125	14						
VENOX STEEL	250	1						
VIVIO 125	125	99					22	507393
ZING	125	0						
CV3 LEFT/IZQ	550	21						
PEOPLE 300 RIGHT/DER.	300	8						
PEOPLE S DER,/RIGHT	250	6						
KYMCO 4 WHEELS								
MXU 500 IRS	500	9						
MAXXER 400	400	9						
MAXXER 450	450	10						
MXU 400	400	8						
MXU 450 i	450	13						
MXU 450 i IRS	450	11	12					
MXU 150	150	5		507086	507223		9	
Mxer 150	150	3		507126	507264		26	
MXU 150	150	6		507126	507264		26	
KXR 250 SPORT	250	4		507130	507267	507169	78	
MAXXER 250	250	6		507130	507267	507169	78	
MAXXER 300	300	6		507130	507267	507169	78	
MXU 250	250	5		507130	507267	507169	78	
MXU 300	300	5		507130	507267	507169	78	
URBAN QUAD 250	250	6		507130	507267	507169	78	
MXU 300 R	300	10			507363		179	
MXU 500	500	6			507363		179	

 Plaquettes arrière			 Mâchoires arrière	
SEMI MÉTALLIQUES G1050	SEMI MÉTALLIQUES G1054	SINTERED G1380	N° Schéma	G2165
507107	507246	507158	102	
507079	507214		38	
507083	507244		19	
507083	507244		19	
	507234	507180	90	
	507234	507180	90	
507088	507225		31	
	507234	507180	90	
	507234	507180	90	
507145	507282	507187	111	
507107	507246	507158	102	
	507234	507180	90	
507126	507264		26	
507126	507264		26	
507126	507264		26	
	507234	507180	90	
507107	507246	507158	102	
507126	507264		26	
507128	507167		44	
507107	507246	507158	102	
	507234	507180	90	
	507234	507180	90	
	507234	507180	90	
	507234	507180	90	
	507363		179	
	507364		180	
	507364		180	
	507364		180	
	507364		180	
	507364		180	
			2	507373
	507363		179	
	507363		179	
	507363		179	
	507363		179	
	507363		179	
	507363		179	
	507363		179	
	507363		179	
	507363		179	

PLAQUETTES DE FREIN - MÂCHOIRES DE FREIN / BRAKE PADS - BRAKE SHOE

CGN
LE SENS DU DÉTAIL

MOTEUR

CYCLE

PNEUMATIQUE

ATELIER

ACCESSOIRES



ÉLECTRICITÉ

FILTRATION

FREINAGE

TRANSMISSION

Modèle	Cylindre	Depuis	Jusqu'à	GALFER MOTO Plaquettes avant			N° Schéma	Mâchoires avant G2165
				SEMI MÉTALLIQUES G1050	SEMI MÉTALLIQUES G1054	SINTERED G1380		
LAMBRETTA								
PATO 125 N	125	9		507079	507214		38	
PATO 150 N	150	9		507079	507214		38	
G 325	325	20		507088	507225		31	
X 125	125	22		507111	507328	507160	5	
X 300	300	22		507111	507328	507160	5	
V 125 SPECIAL PIRELLI EDITION	125	19		507111	507328	507160	5	
V 200	200	20		507111	507328	507160	5	
125 DL	125	14					25	507398
125 LI	125	14					25	507397
150 DL	150	14					25	507398
150 LI	150	14					25	507397
175 LI	175	14					25	507397
175 TV II	175	14					25	507397
200 DL	200	14					25	507398
LN 125	125	12						
LANVERTTI								
NEON 125	125	6						
LAVERDA								
350 RS, PF, ALPINO	350	77		507074	507202		2	
500 RS, PF, ALPINO, MONTJUICH	500	77		507074	507202		2	
350 GS LESMO	350	86		507074	507202		2	
650	650	92		507074	507202		2	
750 BLACK STRIKE	750	98		507074	507202		2	
750 FORMULA	750	98		507074	507202		2	
750 SUPER SPORT	750	0		507074	507202		2	
GHOST	650	96	97	507074	507202		2	
SPORT	650	95		507074	507202		2	
125 NAVARRO	125	90		507074	507202		2	
650 VT TT BAJA	650	86		507074	507202		2	
1000 3C. 3CE. 3CL	1000	74			507203		118	
1000 J, RGS, EXECUTIVE	1000	77			507203		118	
1000 TGA	1000	84			507203		118	
1200 TS	1200	81			507203		118	
500 SFC	500	78			507203		118	
750 SF2, SF3	750	74			507203		118	
125 GS LESMO	125	86		507075	507210		4	
668 HIDALGO	668	90		507081	507216		23	
700 EL CID	700	90		507081	507216		23	
SFC 1000	1000	3		507116	507252	507164	14	
125	125	83						
175	175	83						

 Plaquettes arrière			 Mâchoires arrière	
SEMI MÉTALLIQUES G1050	SEMI MÉTALLIQUES G1054	SINTERED G1380	N° Schéma	G2165
507079	507214		38	
507079	507214		38	
507088	507225		31	
507107	507246	507158	102	
507107	507246	507158	102	
507108	507247	507159	34	
507108	507247	507159	34	
			25	507398
			25	507397
			25	507398
			25	507397
			25	507397
			25	507397
			25	507397
507108	507247	507159	34	
507086	507223		9	
507074	507202		2	
507074	507202		2	
	507203		118	
507078	507213		87	
507078	507213		87	
507078	507213		87	
507078	507213		87	
507078	507213		87	
507078	507213		87	
507078	507213		87	
	507298		123	
	507203		118	
	507203		118	
	507203		118	
	507203		118	
	507203		118	
	507203		118	
507075	507210		4	
507081	507216		23	
507081	507216		23	
	507347		161	
507075	507210		4	
507075	507210		4	

PLAQUETTES DE FREIN - MÂCHOIRES DE FREIN / BRAKE PADS - BRAKE SHOE

MOTEUR

CYCLE

PNEUMATIQUE

ATELIER

ACCESSOIRES



ÉLECTRICITÉ

FILTRATION

FREINAGE

TRANSMISSION

Modèle	Cylindre	Depuis	Jusqu'à	GALFER MOTO			GALFER MOTO	
				Plaquettes avant			Mâchoires avant	
				SEMI MÉTALLIQUES G1050	SEMI MÉTALLIQUES G1054	SINTERED G1380	N° Schéma	G2165
125 LBI FORMULA	125	86						
125 RIDE	125	86						
125 TOLEDO	125	90						
600 CR CRUISER	600	87						
600 OR ATLAS	600	86						
LIFAN COLOMBIA								
LF 150 GY 3A	150			507088	507225		31	
LF 200 GY 2	200			507088	507225		31	
LF 125-3	125							
LF 125-5	125							
LF 200 III SBK	200							
LF 250 V2	250							
LINHAI								
MAIN STR. 260	260	4		507115	507251	507163	66	
MONARCH	160	4		507115	507251	507163	66	
LML								
STAR 2T (TODAS)	125	10						
STAR 2T (TODAS)	150	10						
STAR 4T (TODAS)	125	10						
STAR 4T (TODAS)	151	10						
STAR 4T (TODAS)	200	12						
STAR ART (TODAS)	200	12						
STAR BICOLOR VINTAGE 4T	125	10						
STAR BICOLOR VINTAGE 4T	151	10						
STAR CORSA 4T	165	10						
STAR GT (TODAS)	200	12						
STAR GT 2T	125	10						
STAR GT 2T	150	10						
STAR GT 4T	125	10						
STAR GT 4T	151	10						
STAR MAT SERIES 4T	125	10						
STAR MAT SERIES 4T	151	10						
STAR OFF ROAD	200	12						
STAR RS 4T	125	10						
STAR RS 4T	151	10						
STAR RS/SPORT	200	12						
STAR URBAN (TODAS)	200	12						
LONCIN								
LX 125	125	2						
LX 150	150	2						
MACBOR								
MONTANA XRI	125	21			507305		130	

 Plaquettes arrière			 Mâchoires arrière	
SEMI MÉTALLIQUES G1050	SEMI MÉTALLIQUES G1054	SINTERED G1380	N° Schéma	G2165
507075	507210		4	
507075	507210		4	
	507298		123	
	507298		123	
	507203		118	
507088	507225		31	
507088	507225		31	
507086	507223		9	
507079	507214		38	
507104	507242	507157	63	
507104	507242	507157	63	
507104	507242	507157	63	
507104	507242	507157	63	
507101	507238		99	
507101	507238		99	
507101	507238		99	
507101	507238		99	
507101	507238		99	
507101	507238		99	
507101	507238		99	
507101	507238		99	
507101	507238		99	
507101	507238		99	
507101	507238		99	
507101	507238		99	
507101	507238		99	
507101	507238		99	
507101	507238		99	
507101	507238		99	
507101	507238		99	
507101	507238		99	
507101	507238		99	
507101	507238		99	
507101	507238		99	
507101	507238		99	
507101	507238		99	
507101	507238		99	
507111	507328	507160	5	
507101	507238		99	
507101	507238		99	
507101	507238		99	
507101	507238		99	
	507234	507180	90	
507104	507242	507157	63	
507128	507167		44	

PLAQUETTES DE FREIN - MÂCHOIRES DE FREIN / BRAKE PADS - BRAKE SHOE

MOTEUR

CYCLE

PNEUMATIQUE

ATELIER

ACCESSOIRES



ÉLECTRICITÉ

FILTRATION

FREINAGE

TRANSMISSION

Modèle	Cylindre	Depuis	Jusqu'à	GALFER MOTO Plaquettes avant			N° Schéma	GALFER MOTO Mâchoires avant G2165
				SEMI MÉTALLIQUES G1050	SEMI MÉTALLIQUES G1054	SINTERED G1380		
MONTANA XR5	500	21			507320		145	
EIGHT MILE 500 SCRAMBLER	500	22						
EIGHT MILE 500 STREET	500	22						
MACBOR 4 WHEELS								
CX 250 / R	250	5		507107	507246	507158	102	
MAGURA								
4 PADS CALIPER SM		7						
MAICO								
250 MD	250	83						
500 GM	500	85						
MALAGUTI								
MONTE PRO	125	20		507081	507216		23	
X SM 125	125	19		507081	507216		23	
X TM 125	125	19		507081	507216		23	
CIAK	125	3		507102	507239	507156	3	
CIAK	150	3		507102	507239	507156	3	
MADISON 180	180	2		507116	507252	507164	14	
MADISON 200	200	4		507116	507252	507164	14	
MADISON 3 125	125	7		507116	507252	507164	14	
MADISON 3 250 i.e.	250	7		507116	507252	507164	14	
PHANTOM MAX 125	125	4		507116	507252	507164	14	
PHANTOM MAX 200	200	4		507116	507252	507164	14	
MADISON 125 R 125	125	6	6	507120	507256	507166	7	
MADISON RS 250	250	6	6	507120	507256	507166	7	
PASSWORD 250	250	5	6	507120	507256	507166	7	
SPIDER MAX GT 500	500	4		507120	507256	507166	7	
F 18 WARRIOR	125	0	3	507120	507256	507166	7	
F 18 WARRIOR	150	0	3	507120	507256	507166	7	
MADISON 125	125	99	5	507120	507256	507166	7	
MADISON 150	150	0		507120	507256	507166	7	
PASSWORD 250	250	7		507120	507256	507166	7	
PHANTOM MAX 250	250	5		507120	507256	507166	7	
MADISON 250	250	99	5	507120	507256	507166	7	
MADISON 400	400	1	5	507120	507256	507166	7	
MADISON K 400	400	6		507120	507256	507166	7	
125 RUNNER RALLY	125	93						
MALANCA								
125 GTI	125	83		507074	507202		2	
125 SPORT	125	83		507074	507202		2	
E2CS, 5N, 6N	125	82						
ENDURO MARK, ST, 54, GT 55	125	85						
OB, ONC, 6M	125	83						

				
Plaquettes arrière			Mâchoires arrière	
SEMI MÉTALLIQUES G1050	SEMI MÉTALLIQUES G1054	SINTERED G1380	N° Schéma	G2165
507128	507167		44	
507128	507167		44	
507128	507167		44	
	507361		173	
507074	507202		2	
507074	507202		2	
	507221		33	
507147	507286	507177	59	
507147	507286	507177	59	
507102	507239	507156	3	
507102	507239	507156	3	
507143	507230	507154	48	
507143	507230	507154	48	
		507181	37	
		507181	37	
		507181	37	
		507181	37	
507080	507215		88	
507080	507215		88	
507080	507215		88	
507080	507215		88	
507102	507239	507156	3	
507102	507239	507156	3	
		507181	37	
		507181	37	
		507181	37	
		507181	37	
507123	507259	507183	50	
507123	507259	507183	50	
507123	507259	507183	50	
507080	507215		88	
507074	507202		2	
507074	507202		2	
507074	507202		2	
507075	507210		4	

PLAQUETTES DE FREIN - MÂCHOIRES DE FREIN / BRAKE PADS - BRAKE SHOE

MOTEUR

CYCLE

PNEUMATIQUE

ATELIER

ACCESSOIRES



ÉLECTRICITÉ

FILTRATION

FREINAGE

TRANSMISSION

Modèle	Cylindre	Depuis	Jusqu'à	GALFER MOTO Plaquettes avant			N° Schéma	GALFER MOTO Mâchoires avant G2165
				SEMI MÉTALLIQUES G1050	SEMI MÉTALLIQUES G1054	SINTERED G1380		
MASAI 4 WHEELS								
L 150	150	5		507081	507216		23	
A 300 QUAD	300	5		507130	507267	507169	78	
A 450 QUAD	450	5		507130	507267	507169	78	
MASH								
CITY	125	18		507079	507214		38	
BLACK SEVEN	250	17		507086	507223		9	
CAFÉ RACER	125	14		507086	507223		9	
CAFÉ RACER	250	14		507086	507223		9	
SEVENTY FIVE	125	14		507086	507223		9	
ROADSTAR	400	14						
SCRAMBLER	125	14						
SCRAMBLER	400	17						
SEVENTY	125	14						
TT 40	400	17						
MBK MOTOBKANE								
KILIBRE	300	3		507143	507230	507154	48	
SKYCRUISER ABS	125	11		507115	507251	507163	66	
SKYLINER	250	0		507115	507251	507163	66	
SKYLINER	125	1		507116	507252	507164	14	
SKYLINER	150	1		507116	507252	507164	14	
SKYLINER	180	3		507116	507252	507164	14	
THUNDER	125	1		507116	507252	507164	14	
THUNDER	150	1		507116	507252	507164	14	
SKYCRUISER	125	10		507116	507252	507164	14	
CITYLINER	125	9		507116	507252	507164	14	
SKYCRUISER	125	6	9	507116	507252	507164	14	
SKYLINER	400	4			507279	507186	60	
DOODO	125	0					20	507391
DOODO	150	1					20	507391
FLAME	125	0	3				13	507384
FLAME X	125	4					13	507384
SKYLINER	125	99	0				20	507391
X - OVER	125	10					13	507384
MERLIN								
DG 350 CRESTA	350	87		507077	507212	507151	6	
DG 350 FIUS	350	87		507077	507212	507151	6	
DG-7 125	125	87		507077	507212	507151	6	
NOMADA 500 4T	400	87						
METRAKIT								
PRE GP 125	125	7		507118	507254		106	

 Plaquettes arrière			 Mâchoires arrière	
SEMI MÉTALLIQUES G1050	SEMI MÉTALLIQUES G1054	SINTERED G1380	N° Schéma	G2165
507085	507222	507152	25	
507085	507222	507152	25	
507079	507214		38	
507079	507214		38	
507128	507167		44	
507124	507260		24	
507128	507167		44	
507124	507260		24	
507078	507213		87	
507143	507230	507154	48	
507094	507231		46	
507104	507242	507157	63	
507143	507230	507154	48	
507143	507230	507154	48	
507143	507230	507154	48	
507143	507230	507154	48	
507143	507230	507154	48	
507094	507231		46	
507093	507280	507175	49	
507093	507280	507175	49	
507095	507232	507155	62	
507102	507239	507156	3	
507102	507239	507156	3	
507082	507218		70	
507138	507275		110	
507143	507230	507154	48	
	507288	507191	92	
507077	507212	507151	6	
507077	507212	507151	6	
507077	507212	507151	6	
507074	507202		2	
507137	507274		21	

PLAQUETTES DE FREIN - MÂCHOIRES DE FREIN / BRAKE PADS - BRAKE SHOE

CGN
LE SENS DU DÉTAIL

MOTEUR

CYCLE

PNEUMATIQUE

ATELIER

ACCESSOIRES



ÉLECTRICITÉ

FILTRATION

FREINAGE



TRANSMISSION

Modèle	Cylindre	Depuis	Jusqu'à	GALFER MOTO Plaquettes avant			N° Schéma	Mâchoires avant G2165
				SEMI MÉTALLIQUES G1050	SEMI MÉTALLIQUES G1054	SINTERED G1380		
MINELLI								
OMEGA 125	125	6		507115	507251	507163	66	
OMEGA 250	250	6		507115	507251	507163	66	
MONDIAL								
EVO	1000	3		507116	507252	507164		
NUDA	1000	3		507116	507252	507164		
PIEGA 1000	1000	3		507116	507252	507164		
MONKEY BIKE								
MB 125 SM	125	6		507077	507212	507151		
MB 125 TR	125	6		507077	507212	507151		
MB 200 SM	200	6		507077	507212	507151		
MB 200 TR	200	6		507077	507212	507151		
MB OCTOPUS 125	125	6						
MONTESA								
COTA 309	309	89		507074	507202			
COTA 307	307	87		507077	507212	507151		
COTA 330	330	87		507077	507212	507151		
4 RIDE	260	16	17	507118	507254			
4 RIDE	260	18		507118	507254			
COTA 260 4RT	260	15	17	507118	507254			
COTA 260 4RT	260	18		507118	507254			
COTA 260 4RT RACE REPLIC	260	15	17	507118	507254			
COTA 300 RR	300	15	17	507118	507254			
COTA 300 RR	300	18		507118	507254			
COTA 4 RT	250	5	11	507118	507254			
COTA 4 RT	250	12		507118	507254			
COTA 304	304	86						
ENDURO 360 H7	360	87						
ENDURO 360 H7	360	86						
ENDURO 360 M7	360	85						
MORBIDELLI								
125 JR	125	80		507077	507212	507151		
MOTO GUZZI								
1100 SPORT	1100	95	97	507074	507202			
125 BX	125	92		507074	507202			
350 FALCO	350	88		507074	507202			
350 GTS	350	77		507074	507202			
350 IMOLA, II	350	78		507074	507202			
350 NEVADA	350	92		507074	507202			
350 NTX	350	88		507074	507202			
350 TRENTACINQUE GT	350	92		507074	507202			
400 GTS	400	79		507074	507202			

 Plaquettes arrière			 Mâchoires arrière	
SEMI MÉTALLIQUES G1050	SEMI MÉTALLIQUES G1054	SINTERED G1380	N° Schéma	G2165
507104	507242	507157	63	
507104	507242	507157	63	
	507347		161	
	507347		161	
	507347		161	
		507181	37	
		507181	37	
		507181	37	
		507181	37	
507086	507223		9	
507077	507212	507151	6	
507077	507212	507151	6	
507077	507212	507151	6	
	507343		157	
	507343		157	
507077	507212	507151	6	
507074	507202		2	
	507294		119	
507077	507212	507151	6	
507077	507212	507151	6	
507078	507213		87	
507074	507202		2	
507074	507202		2	
507074	507202		2	
507074	507202		2	
507074	507202		2	
507074	507202		2	
507074	507202		2	
507074	507202		2	
507074	507202		2	

PLAQUETTES DE FREIN - MÂCHOIRES DE FREIN / BRAKE PADS - BRAKE SHOE

Modèle	Cylindre	Depuis	Jusqu'à	Plaquettes avant			Mâchoires avant	
				SEMI MÉTALLIQUES G1050	SEMI MÉTALLIQUES G1054	SINTERED G1380	N° Schéma	G2165
500 MONZA	500	78		507074	507202			
650 GT SESSANTACINQUE	650	89		507074	507202			
650 NTX	650	88		507074	507202			
750 BREVA i.e.	750	3		507074	507202			
750 DUNA	750	86		507074	507202			
750 NEVADA	750	92		507074	507202			
750 NEVADA CLUB	750	98		507074	507202			
750 NTX	750	89		507074	507202			
750 SP	750	92		507074	507202			
750 TARGA	750	89		507074	507202			
750 V 75	750	76		507074	507202			
CENTAURO	1000	96		507074	507202			
DAYTONA i.e	1000	91	94	507074	507202			
DAYTONA i.e	1000	95		507074	507202			
MILLE GT	1000	92		507074	507202			
V 35 FLORIDA III	350	92		507074	507202			
V 35 I, II, III, C, TT	350	78		507074	507202			
V 50 I, II, III, MONZA CHOPER	500	80		507074	507202			
V 50 POLIZIA MILITARE	500	80		507074	507202			
V 65 BAJA	650	86		507074	507202			
V 65 C	650	85		507074	507202			
V 65 FLORIDA	650	86		507074	507202			
V 65 LARIO	650	82		507074	507202			
V 65 SP, TT, CHOPER, POLIZIA	650	76		507074	507202			
V 65 TT	650	85		507074	507202			
V10 CENTAURO SPORT	1100	99		507074	507202			
V11 LE MANS ROSSO CORSA	1100	3		507074	507202			
V11 SCURA	1100	3		507074	507202			
V11 SPORT / LE MANS	1100	99		507074	507202			
1000 CALIFORNIA II, FUEL INJECTION	1000	89			507203			
1000 CALIFORNIA III C.I./I.E	1000	92			507203			
1000 CALIFORNIA, POLIZIA	1000	84			507203			
1000 SP III i.e.	1000	92			507203			
1000 V G5, CONVERT	1000	81			507203			
1000 V SPADA, SPII, NT	1000	81			507203			
1100 I CALIFORNIA	1100	94			507203			
1100 I CALIFORNIA	1100	95			507203			
750 S, S3	750	76			507203			
850 CALIFORNIA I, II	850	75			507203			
850 LE MANS I, II, III	850	76			507203			
850 T, T3, T4, T5, POLIZIA	850	76			507203			
1000 SP, GS, NT, CALIFORNIA	1000	80			507209			

				
Plaquettes arrière			Mâchoires arrière	
SEMI MÉTALLIQUES G1050	SEMI MÉTALLIQUES G1054	SINTERED G1380	N° Schéma	G2165
507074	507202		2	
507074	507202		2	
507074	507202		2	
	507324		149	
507074	507202		2	
507074	507202		2	
507074	507202		2	
507074	507202		2	
507074	507202		2	
507074	507202		2	
507074	507202		2	
507078	507213		87	
507078	507213		87	
507078	507213		87	
	507203		118	
507074	507202		2	
507074	507202		2	
507074	507202		2	
507074	507202		2	
507074	507202		2	
507074	507202		2	
507074	507202		2	
507074	507202		2	
507074	507202		2	
507074	507202		2	
507078	507213		87	
	507324		149	
	507324		149	
	507324		149	
	507203		118	
	507203		118	
	507203		118	
	507203		118	
	507203		118	
	507203		118	
	507203		118	
507078	507213		87	
	507203		118	
	507203		118	
	507203		118	
	507203		118	
	507203		118	

PLAQUETTES DE FREIN - MÂCHOIRES DE FREIN / BRAKE PADS - BRAKE SHOE

CGN
LE SENS DU DÉTAIL

MOTEUR

CYCLE

PNEUMATIQUE

ATELIER

ACCESSOIRES



ÉLECTRICITÉ

FILTRATION

FREINAGE

TRANSMISSION

Modèle	Cylindre	Depuis	Jusqu'à	GALFER MOTO			Plaquettes avant		Mâchoires avant	
				SEMI MÉTALLIQUES G1050	SEMI MÉTALLIQUES G1054	SINTERED G1380	N° Schéma	G2165		
V7 CLASSIC CAFÉ	750	9		507080	507215					
V7 III	750	17		507080	507215					
V7 III CARBON	750	18		507080	507215					
V7 III MILANO	750	18		507080	507215					
V7 III ROUGH	750	18		507080	507215					
V7 RACER	750	11		507080	507215					
V7 SCRAMBLER	750	12		507080	507215					
V85 TT	850	19		507080	507215					
V85 TT GUARDIA d'ONORE	850	22		507080	507215					
QUOTA I.E.	1000	91			507298					
BREVA 1100	1100	5		507143	507230	507154				
CALIFORNIA ESPECIAL	1100	99		507143	507230	507154				
CALIFORNIA EV	1100	97		507143	507230	507154				
CALIFORNIA JACKAL	1100	99		507143	507230	507154				
CALIFORNIA SPECIAL SPORT	1000	3		507143	507230	507154				
CALIFORNIA STONE	1000	3		507143	507230	507154				
GRISO	1100	5	8	507143	507230	507154				
GRISO	1200	7	15	507143	507230	507154				
NORGE 1200	1200	6		507143	507230	507154				
NORGE 1200 GT 8V	1200	11		507143	507230	507154				
SPORT 1200	1200	7	8	507143	507230	507154				
SPORT 1200 V4	1200	9		507143	507230	507154				
STELVIO	1150	8	10	507143	507230	507154				
STELVIO	1200	11		507143	507230	507154				
STELVIO NTX	1200	11	11	507143	507230	507154				
STELVIO NTX	1200	12		507143	507230	507154				
STELVIO TT	1150	9	10	507143	507230	507154				
V12 LE MANS	1200	10		507143	507230	507154				
V12 STRADA	1200	10		507143	507230	507154				
V12 X	1200	10		507143	507230	507154				
AUDACE	1400	15			507322					
AUDACE CARBON	1400	17			507322					
CALIFORNIA CUSTOM	1400	13			507322					
CALIFORNIA TOURING	1400	13			507322					
EL DORADO	1400	15			507322					
MGX-21	1400	20			507322					
CALIFORNIA AQUILA NERA	1000	10		507116	507252	507164				
EV STONE	1000	2		507116	507252	507164				
GRISO 850 8V	850	6	8	507116	507252	507164				
GRISO 850 8V SE SPECIAL EDITION	850	9		507116	507252	507164				
MGS/01 1000	1000	3		507116	507252	507164				
NEVADA 750 AQUILA NERA	750	10		507116	507252	507164				

				
Plaquettes arrière			Mâchoires arrière	
SEMI MÉTALLIQUES G1050	SEMI MÉTALLIQUES G1054	SINTERED G1380	N° Schéma	G2165
	507324		149	
	507324		149	
	507324		149	
	507324		149	
	507324		149	
	507324		149	
	507324		149	
	507324		149	
	507324		149	
	507324		149	
507078	507213		87	
507078	507213		87	
507078	507213		87	
	507324		149	
	507324		149	
	507324		149	
	507324		149	
	507324		149	
	507324		149	
	507324		149	
	507324		149	
	507324		149	
	507324		149	
	507347		161	
	507324		149	
	507324		149	
	507324		149	
	507324		149	
	507324		149	
	507324		149	
	507324		149	
	507324		149	
	507324		149	
	507324		149	
	507324		149	
	507347		161	
	507324		149	

MOTEUR

CYCLE

PNEUMATIQUE

ATELIER

ACCESSOIRES

ÉLECTRICITÉ

FILTRATION

FREINAGE

TRANSMISSION

PLAQUETTES DE FREIN - MÂCHOIRES DE FREIN / BRAKE PADS - BRAKE SHOE

MOTEUR

CYCLE

PNEUMATIQUE

ATELIER

ACCESSOIRES

ÉLECTRICITÉ

FILTRATION

FREINAGE

TRANSMISSION

Modèle	Cylindre	Depuis	Jusqu'à	GALFER MOTO Plaquettes avant			GALFER MOTO Mâchoires avant	
				SEMI MÉTALLIQUES G1050	SEMI MÉTALLIQUES G1054	SINTERED G1380	N° Schéma	G2165
STR 1100	1100	4		507116	507252	507164		
STR BREVA 850	850	6		507116	507252	507164		
STR V 750 ie	750	3		507116	507252	507164		
VII SPORT BALLABIO	1100	3		507116	507252	507164		
V7 CLASSIC	750	8		507116	507252	507164		
V9 BOBBER	850	17		507116	507252	507164		
V9 ROAMER	850	17		507116	507252	507164		
125 C	125	92						
125 TT,C	125	85						
250 TS	250	75						
250/4	250	77						
MOTO MORINI								
350 DART	350	88		507074	507202			
350 KANGURO	350	88		507074	507202			
350 NEW YORK	350	88		507074	507202			
400 DART	400	89		507074	507202			
400 S	400	95		507074	507202			
501 CAMEL	501	88		507074	507202			
501 COGUANO	501	89		507074	507202			
501 COGUARRO	501	88		507074	507202			
501 EXCALIBUR	501	88		507074	507202			
501 EXCALIBUR	501	89		507074	507202			
501 NEW YORK	501	88		507074	507202			
501 NEW YORK	501	89		507074	507202			
501XE	501	88		507074	507202			
350 EXCALIBUR	350	86						
GRANFERRO	1200	10		507143	507230	507154		
GRANPASSO	1200	8		507143	507230	507154		
SCRAMBLER	1200	9	17	507143	507230	507154		
SEIEMMEZZO	650	20		507143	507230	507154		
X - CAPE	650	20	22	507143	507230	507154		
9.5	950	5		507116	507252	507164		
CORSARO 1200	1200	5		507116	507252	507164		
CORSARO AVIO 1200	1200	8		507116	507252	507164		
CORSARO ESPECIAL	1200	20		507116	507252	507164		
CORSARO ZT	1200	20		507116	507252	507164		
CORSARO ZZ	1200	18		507116	507252	507164		
MILANO	1200	18		507116	507252	507164		
MM3	1200	7		507116	507252	507164		
SCRAMBLER	1200	18		507116	507252	507164		
SEIEMMEZZO SCR	650	23		507116	507252	507164		
SEIEMMEZZO STR	650	23		507116	507252	507164		

GALFER MOTO			GALFER MOTO	
Plaquettes arrière			Mâchoires arrière	
SEMI MÉTALLIQUES G1050	SEMI MÉTALLIQUES G1054	SINTERED G1380	N° Schéma	G2165
	507324		149	
	507324		149	
	507324		149	
	507324		149	
	507324		149	
	507324		149	
	507324		149	
507074	507202		2	
507074	507202		2	
507074	507202		2	
507074	507202		2	
	507298		123	
507080	507215		88	
	507298		123	
	507298		123	
507074	507202		2	
507080	507215		88	
	507298		123	
507080	507215		88	
	507298		123	
507074	507202		2	
	507298		123	
	507298		123	
507080	507215		88	
	507322		147	
	507322		147	
507128	507167		44	
507128	507167		44	
	507324		149	
	507324		149	
	507324		149	
	507324		149	
	507322		147	
	507322		147	

Modèle	Cylindre	Depuis	Jusqu'à	GALFER MOTO Plaquettes avant			GALFER MOTO Mâchoires avant	
				SEMI MÉTALLIQUES G1050	SEMI MÉTALLIQUES G1054	SINTERED G1380	N° Schéma	G2165
SUPER SCRAMBLER	1200	20		507116	507252	507164		
X - CAPE	650	23		507116	507252	507164		
250 COUNTRY XE	250	88						
501 EXCALIBUR	501	86						
MOTOM								
DOLCEVITA	125	7		507079	507214			
DOLCEVITA	150	7		507079	507214			
TRANSCITY	125	7		507079	507214			
TRANSCITY	150	7		507079	507214			
LAMBRETTA	125	8						
MOTORHISPANIA								
ARENA ENDURO	125	5		507077	507212	507151		
ARENA MOTARD	125	5		507077	507212	507151		
DUNA DUAL SPORT	125	9		507077	507212	507151		
MH 10 PRO 125 LC	125	12		507081	507216			
MH 10 PRO 125 LC SM	125	12		507081	507216			
DUNA SPORT CITY	125	9		507124	507260			
KN 1 NAKED	125	10		507124	507260			
KN 2 NAKED	125	14		507124	507260			
MH 7 NAKED	125	7		507124	507260			
RX 125 R	125	8		507124	507260			
MOTOTRANS								
350 VENTO	350	75		507074	507202			
500 TWIN/DESMO	500	75		507074	507202			
350 FORZA	350	75						
MV AGUSTA								
750 AMERICA	750	72			507203			
800 SS	800	73			507203			
CORONA 1000	1000	72			507203			
GP 1000	1000	73			507203			
LUCKY EXPLORER 5,5	550	22			507320			
B3 800 RR	800	17		507116	507252	507164		
BRUTALE 1000 RR /SERIE ORO	1000	20		507116	507252	507164		
BRUTALE 800	800	13		507116	507252	507164		
BRUTALE 800 RR	800	15		507116	507252	507164		
BRUTALE 800 RR SCS	800	20		507116	507252	507164		
DRAGSTER 800 RC	800	17		507116	507252	507164		
DRAGSTER 800 RR	800	15		507116	507252	507164		
DRAGSTER 800 RR SCS	800	20		507116	507252	507164		
F-3 800	800	16		507116	507252	507164		
F-3 800 RC	800	16		507116	507252	507164		
F-3 800 RR	800	21		507116	507252	507164		

GALFER MOTO			GALFER MOTO	
Plaquettes arrière			Mâchoires arrière	
SEMI MÉTALLIQUES G1050	SEMI MÉTALLIQUES G1054	SINTERED G1380	N° Schéma	G2165
	507322		147	
507074	507202		2	
507080	507215		88	
507083	507244		19	
507083	507244		19	
507104	507242	507157	63	
507104	507242	507157	63	
507083	507244		19	
507077	507212	507151	6	
	507227	507153	39	
		507181	37	
		507181	37	
507137	507274		21	
		507181	37	
507137	507274		21	
507137	507274		21	
507137	507274		21	
507137	507274		21	
507074	507202		2	
507074	507202		2	
507074	507202		2	
	507203		118	
	507203		118	
	507203		118	
	507203		118	
	507199		83	
	507324		149	
	507324		149	
	507324		149	
	507324		149	
	507324		149	
	507324		149	
	507324		149	

PLAQUETTES DE FREIN - MÂCHOIRES DE FREIN / BRAKE PADS - BRAKE SHOE

CGN
LE SENS DU DÉTAIL

MOTEUR

CYCLE

PNEUMATIQUE

ATELIER

ACCESSOIRES



ÉLECTRICITÉ

FILTRATION

FREINAGE

TRANSMISSION

Modèle	Cylindre	Depuis	Jusqu'à	GALFER MOTO			GALFER MOTO	
				Plaquettes avant			Mâchoires avant	
				SEMI MÉTALLIQUES G1050	SEMI MÉTALLIQUES G1054	SINTERED G1380	N° Schéma	G2165
F-4	1000	16		507116	507252	507164		
F-4 LH44	1000	18		507116	507252	507164		
F-4 RC	1000	16		507116	507252	507164		
RIVALE 800	800	13		507116	507252	507164		
RUSH 1000	1000	20		507116	507252	507164		
RVS#1	800	18		507116	507252	507164		
STRADALE 800	800	15		507116	507252	507164		
SUPERVELOCE 800 / SERIE ORO	800	20		507116	507252	507164		
TURISMO VELOCE	800	14		507116	507252	507164		
TURISMO VELOCE LUSO	800	14		507116	507252	507164		
BRUTALE 989	1000	8	9					
BRUTALE 990 R	1000	10						
F-4 1000	1000	6	6					
MZ/MUZ								
BAGHIRA	660	0		507081	507216			
MASTIFF	660	0		507081	507216			
SKORPION	500	94						
1000 S	1000	1		507116	507252	507164		
ETZ 250	250	82						
ETZ 301	301	85						
SAXON	500	93						
SILVER STAR	500	93						
NIU								
N	EL	18			507320			
NORTON								
INTERPOL 2	850	82			507203			
WANKEL CLASSIC	850	88			507203			
V4 RR	1200	18		507116	507252	507164		
OSSA								
500 YANQUEE	500	78		507074	507202			
EXPLORER 280i	280	12		507118	507254			
TR 125i	125	15		507118	507254			
TR 250i	250	15		507118	507254			
TR 280i	280	10		507118	507254			
TR 300i	300	15		507118	507254			
TR 300i FACTORY R	300	15		507118	507254			
ENDURO 300i	300	12			507358			
P.G.O.								
STAR 125	125	95		507074	507202			
G-MAX	125	5			507234	507180		
G-MAX	150	5			507234	507180		
G-MAX	250	6			507234	507180		

 Plaquettes arrière			 Mâchoires arrière	
SEMI MÉTALLIQUES G1050	SEMI MÉTALLIQUES G1054	SINTERED G1380	N° Schéma	G2165
	507199		83	
	507324		149	
	507199		83	
	507199		83	
	507199		83	
	507324		149	
	507324		149	
	507347		161	
507080	507215		88	
507080	507215		88	
	507313		134	
	507324		149	
	507203		118	
	507209		188	
	507209		188	
	507209		188	
507134	507271		79	
	507203		118	
	507203		118	
	507203		118	
	507343		157	
	507343		157	
	507343		157	
	507343		157	
	507343		157	
507143	507230	507154	48	
	507234	507180	90	
507078	507213		87	
507078	507213		87	
507078	507213		87	

PLAQUETTES DE FREIN - MÂCHOIRES DE FREIN / BRAKE PADS - BRAKE SHOE

CGN
LE SENS DU DÉTAIL

MOTEUR

CYCLE

PNEUMATIQUE

ATELIER

ACCESSOIRES



ÉLECTRICITÉ

FILTRATION

FREINAGE

TRANSMISSION

Modèle	Cylindre	Depuis	Jusqu'à	GALFER MOTO Plaquettes avant			GALFER MOTO Mâchoires avant	
				SEMI MÉTALLIQUES G1050	SEMI MÉTALLIQUES G1054	SINTERED G1380	N° Schéma	G2165
LIBRA 125	125	9						
LIBRA 150	150	9						
LIGERO 125	125	6						
T-REX 125 4-T	125	99						
T-REX 150 4-T	150	1						
P.G.O. 4 WHEELS								
X-RIDER 150	150	3		507085	507222	507152		
PETRONAS								
FP 1	1000	5		507116	507252	507164		
PEUGEOT								
ELYSEO 125	125	1		507077	507212	507151		
LOOXOR	125	1	4	507077	507212	507151		
LOOXOR	150	2		507077	507212	507151		
XPS CT 125	125	6		507077	507212	507151		
METROPOLIS 400i	400	12			507221			
SATELIS 250 RS	250	10			507221			
SATELIS 300i	300	13			507221			
SV 250	250	3			507315			
E-SATELIS	EL	11		507107	507246	507158		
GEO 400 RS	400	10		507107	507246	507158		
GEO STYLE 300	300	10		507107	507246	507158		
GEOPOLIS 125 (NISSIN)	125	6		507107	507246	507158		
GEOPOLIS 300	300	11		507107	507246	507158		
GEOPOLIS 400	400	7		507107	507246	507158		
SATELIS 500	500	10		507107	507246	507158		
SATELIS 125 RS	125	13		507111	507328	507160		
SATELIS 250 CITY	250	6		507111	507328	507160		
TWEET 125	125	10		507111	507328	507160		
TWEET 150	150	10		507111	507328	507160		
DJANGO ALLURE	125	14		507116	507252	507164		
DJANGO EVASION	150	14		507116	507252	507164		
DJANGO HERITAGE	150	14		507116	507252	507164		
DJANGO SPORT	125	14		507116	507252	507164		
SATELIS 400	400	7		507116	507252	507164		
SATELIS 400 ABS PBS	400	7		507116	507252	507164		
SATELIS 500	500	7	9	507116	507252	507164		
SATELIS 500	500	6		507116	507252	507164		
SATELIS 500 ABS PBS	500	7		507116	507252	507164		
CITY STAR 125	125	11		507120	507256	507166		
CITY STAR 125 ACTIVE	125	13		507120	507256	507166		
ELISTAR EFI	125	2		507129	507266	507168		
ELYSEO 150	150	1		507129	507266	507168		

				
Plaquettes arrière			Mâchoires arrière	
SEMI MÉTALLIQUES G1050	SEMI MÉTALLIQUES G1054	SINTERED G1380	N° Schéma	G2165
507108	507247	507159	34	
507108	507247	507159	34	
507108	507247	507159	34	
507108	507247	507159	34	
507108	507247	507159	34	
	507347		161	
507077	507212	507151	6	
507077	507212	507151	6	
507077	507212	507151	6	
507077	507212	507151	6	
507143	507230	507154	48	
	507221		33	
	507221		33	
507113	507333	507182	53	
507107	507246	507158	102	
507094	507231		46	
507107	507246	507158	102	
507107	507246	507158	102	
507107	507246	507158	102	
507107	507246	507158	102	
507094	507231		46	
	507221		33	
507116	507252	507164	14	
507108	507247	507159	34	
507108	507247	507159	34	
	507221		33	
	507221		33	
	507221		33	
	507221		33	
507094	507231		46	
507094	507231		46	
507094	507231		46	
507116	507252	507164	14	
507094	507231		46	
507131	507268	507170	35	
507131	507268	507170	35	
		507181	37	
		507181	37	

PLAQUETTES DE FREIN - MÂCHOIRES DE FREIN / BRAKE PADS - BRAKE SHOE

CGN
LE SENS DU DÉTAIL

MOTEUR

CYCLE

PNEUMATIQUE

ATELIER

ACCESSOIRES



ÉLECTRICITÉ

FILTRATION

FREINAGE

TRANSMISSION

Modèle	Cylindre	Depuis	Jusqu'à	GALFER MOTO			GALFER MOTO	
				Plaquettes avant			Mâchoires avant	
				SEMI MÉTALLIQUES G1050	SEMI MÉTALLIQUES G1054	SINTERED G1380	N° Schéma	G2165
GEO 125 RS	125	10		507129	507266	507168		
GEO 250 RS	250	10		507129	507266	507168		
GEOPOLIS 125 (AJP)	125	6		507129	507266	507168		
JET FORCE	125	3		507129	507266	507168		
LOOXOR	125	5		507129	507266	507168		
SATELIS 125	125	10		507129	507266	507168		
SATELIS 125 K15 (AJP)	125	6		507129	507266	507168		
SATELIS 125 K15 (NISSIN)	125	7		507129	507266	507168		
SATELIS 125 K15 COMPRESOR (AJP)	125	6		507129	507266	507168		
SATELIS 125 K15 COMPRESOR (NISSIN)	125	7		507129	507266	507168		
GEOPOLIS 250 PREMIUM	250	6		507131	507268	507170		
LXR 125	125	10		507145	507282	507187		
LXR 200	200	10		507145	507282	507187		
E-LUDIX	EL	20						
ELYSEO 125	125	98	0					507373
E-VIVACITY	EL	10						507373
GEO SV	125	92						507373
LUDIX 125	125	4						507373
NEW VIVACITY 125	125	10						
NEW VIVACITY 125 SIXTIES	125	10						
SUM-UP	125	8					10	507381
SV 250	250	1	2				5	507377
SV EXECUTIVE/GEO	125	95						507373
SV EXECUTIVE/GEO	125	91	94					507373
VOX CITY	125	10						
PIAGGIO								
MP 3 NEW 300 BUSINESS	300	15						
MP 3 NEW 300 SPORT	300	15						
BEVERLY 125 4T (G)	125	2				507181		
BEVERLY 200 4T (G)	200	2				507181		
VESPA GTS 125 ABS-ASR	125	17		507111	507328	507160		
VESPA GTS 125 SUPER	125	9	21	507111	507328	507160		
VESPA GTS 125 SUPER	125	22		507111	507328	507160		
VESPA GTS 300 ABS-ASR	300	17		507111	507328	507160		
VESPA GTS 300 SUPER	300	22		507111	507328	507160		
VESPA SUPER SPORT ABS	150	15		507111	507328	507160		
BEVERLY 400 i.e.	400	6		507116	507252	507164		
BEVERLY 400 i.e. TOURER	400	6		507116	507252	507164		
BEVERLY 500	500	3		507116	507252	507164		
X8	125	4	5	507116	507252	507164		
X8 i.e.w. RIGHT/DER.	400	6		507116	507252	507164		
X9	125	1		507116	507252	507164		

				
Plaquettes arrière			Mâchoires arrière	
SEMI MÉTALLIQUES G1050	SEMI MÉTALLIQUES G1054	SINTERED G1380	N° Schéma	G2165
		507181	37	
507107	507246	507158	102	
		507181	37	
		507181	37	
507123	507259	507183	50	
		507181	37	
		507181	37	
	507221		33	
		507181	37	
	507221		33	
507131	507268	507170	35	
		507181	37	
507108	507247	507159	34	
507085	507222	507152	25	
507077	507212	507151	6	
507107	507246	507158	102	
507098	507235		96	
507077	507212	507151	6	
507107	507246	507158	102	
507086	507223		9	
507086	507223		9	
507113	507333	507182	53	
507097	507233		95	
507098	507235		96	
507079	507214		38	
507127	507265		17	
507127	507265		17	
		507181	37	
		507181	37	
507131	507268	507170	35	
507131	507268	507170	35	
	507369		185	
507131	507268	507170	35	
	507369		185	
507131	507268	507170	35	
507143	507230	507154	48	
507116	507252	507164	14	
507116	507252	507164	14	
507131	507268	507170	35	
507136	507273	507171	30	
507116	507252	507164	14	

PLAQUETTES DE FREIN - MÂCHOIRES DE FREIN / BRAKE PADS - BRAKE SHOE

MOTEUR

CYCLE

PNEUMATIQUE

ATELIER

ACCESSOIRES

ÉLECTRICITÉ

FILTRATION

FREINAGE

TRANSMISSION

Modèle	Cylindre	Depuis	Jusqu'à	GALFER MOTO			Plaquettes avant		Mâchoires avant	
				SEMI MÉTALLIQUES G1050	SEMI MÉTALLIQUES G1054	SINTERED G1380	N° Schéma	G2165		
X9	200	1	2	507116	507252	507164				
X9	250	0		507116	507252	507164				
X9	500	1	2	507116	507252	507164				
X9 AMALFI	180	1		507116	507252	507164				
X9 EVOLUTION	500	3		507116	507252	507164				
X9 EVOLUTION DER.	200	3		507116	507252	507164				
X9 EVOLUTION RIGHT/DER.	125	4	5	507116	507252	507164				
X9 i.e.	500	7		507116	507252	507164				
HEXAGON GTX 125 (G)	125	0	0	507127	507265					
HEXAGON GTX 125 (H)	125	0	0	507127	507265					
HEXAGON GTX 150 (G)	150	0		507127	507265					
HEXAGON GTX 150 (H)	150	0		507127	507265					
HEXAGON GTX 180 (G)	180	0	0	507127	507265					
HEXAGON GTX 180 (H)	180	0	0	507127	507265					
HEXAGON GTX 250 (G)	250	0		507127	507265					
HEXAGON GTX 250 (H)	250	0		507127	507265					
SUPER HEXAGON GTX 125 (G)	125	1		507127	507265					
SUPER HEXAGON GTX 125 (H)	125	1		507127	507265					
SUPER HEXAGON GTX 180 (G)	180	1		507127	507265					
SUPER HEXAGON GTX 180 (H)	180	1		507127	507265					
VESPA 946	125	13		507127	507265					
VESPA GRAN TURISMO (G)	125	3		507127	507265					
VESPA GRAN TURISMO (G)	200	3		507127	507265					
VESPA GRAN TURISMO (H)	125	3		507127	507265					
VESPA GRAN TURISMO (H)	200	3		507127	507265					
VESPA GTV 125	125	6		507127	507265					
VESPA RED 946	125	17		507127	507265					
BEVERLY 125	125	10		507131	507268	507170				
BEVERLY 200 4T (H)	200	2		507131	507268	507170				
BEVERLY 250 4T (H)	250	4		507131	507268	507170				
CARNABY 125	125	7		507131	507268	507170				
CARNABY 200	200	7		507131	507268	507170				
CARNABY 250	250	9		507131	507268	507170				
CARNABY CRUISER 300 i.e.	300	9		507131	507268	507170				
MP 3 400 i.e.	400	7		507131	507268	507170				
MP 3 400 LT	400	9		507131	507268	507170				
MP 3 500 SPORT	500	10	14	507131	507268	507170				
MP 3 530 hpe EXCLUSIVE	530	23		507131	507268	507170				
MP 3 LT 500 SPORT ADVANCED	500	21		507131	507268	507170				
MP 3 NEW 500 BUSINESS	500	15		507131	507268	507170				
MP 3 NEW 500 BUSINESS ABS/ASR	500	15		507131	507268	507170				
MP 3 NEW 500 SPORT	500	15		507131	507268	507170				

GALFER MOTO			GALFER MOTO	
Plaquettes arrière			Mâchoires arrière	
SEMI MÉTALLIQUES G1050	SEMI MÉTALLIQUES G1054	SINTERED G1380	N° Schéma	G2165
507116	507252	507164	14	
507116	507252	507164	14	
507116	507252	507164	14	
507116	507252	507164	14	
507143	507230	507154	48	
507136	507273	507171	30	
507136	507273	507171	30	
507143	507230	507154	48	
		507181	37	
507131	507268	507170	35	
		507181	37	
507131	507268	507170	35	
		507181	37	
507131	507268	507170	35	
		507181	37	
507131	507268	507170	35	
		507181	37	
507131	507268	507170	35	
		507181	37	
507131	507268	507170	35	
		507181	37	
507131	507268	507170	35	
507131	507268	507170	35	
507131	507268	507170	35	
507131	507268	507170	35	
507131	507268	507170	35	
507131	507268	507170	35	
507131	507268	507170	35	
507131	507268	507170	35	
507131	507268	507170	35	
507131	507268	507170	35	
507131	507268	507170	35	
507131	507268	507170	35	
507111	507328	507160	5	
507111	507328	507160	5	
507111	507328	507160	5	
507127	507265		17	
507127	507265		17	
507127	507265		17	
507127	507265		17	
507127	507265		17	

PLAQUETTES DE FREIN - MÂCHOIRES DE FREIN / BRAKE PADS - BRAKE SHOE

CGN
LE SENS DU DÉTAIL

MOTEUR

CYCLE

PNEUMATIQUE

ATELIER

ACCESSOIRES



ÉLECTRICITÉ

FILTRATION

FREINAGE

TRANSMISSION

Modèle	Cylindre	Depuis	Jusqu'à	GALFER MOTO Plaquettes avant			GALFER MOTO Mâchoires avant	
				SEMI MÉTALLIQUES G1050	SEMI MÉTALLIQUES G1054	SINTERED G1380	N° Schéma	G2165
MP 3 NEW 500 SPORT ABS/ASR	500	15		507131	507268	507170		
X EVO 250	250	8		507131	507268	507170		
X EVO 400 RIGHT/DER.	400	8		507131	507268	507170		
BEVERLY 125 4T (H)	125	2		507136	507273	507171		
BEVERLY 300	300	10		507136	507273	507171		
BEVERLY 300 HPE	300	22		507136	507273	507171		
BEVERLY 400 HPE S	400	22		507136	507273	507171		
BEVERLY SPORT TOURER	350	12		507136	507273	507171		
BEVERLY TOURER 300	300	9		507136	507273	507171		
MEDLEY 125	125	20		507136	507273	507171		
MEDLEY 150	150	19		507136	507273	507171		
MP 3 250 LT	250	9		507136	507273	507171		
MP 3 300 ie YOURBAN	300	13		507136	507273	507171		
MP 3 300 LT SPORT	300	11		507136	507273	507171		
MP 3 300 YOURBAN	300	11		507136	507273	507171		
MP3 125 LT	125	9		507136	507273	507171		
MP3 125 YOURBAN	125	11		507136	507273	507171		
MP3 HYBRID	125	9		507136	507273	507171		
X EVO 125	125	8		507136	507273	507171		
X7	125	8		507136	507273	507171		
X7	250	8		507136	507273	507171		
X7	300	10		507136	507273	507171		
VESPA GTE 250 I	250	5		507139	507276	507172		
VESPA GTS 300 i.e. SUPER	300	9	21	507139	507276	507172		
X10 RIGHT/DER	125	12		507139	507276	507172		
X10 RIGHT/DER	350	12		507139	507276	507172		
X10 RIGHT/DER	500	12		507139	507276	507172		
X9 EVOLUTION RIGHT/DER.	125	6		507139	507276	507172		
MP 3 250	250	6	8					
MP3 125	125	6	8					
X8	125	6						
X8	200	4						
X8	250	6						
X9 EVOLUTION RIGHT/DER.	250	4						
FLY 125 4T	125	5						
HEXAGON	125	94	97				19	507390
HEXAGON	150	94	99				19	507390
HEXAGON GT 250 4T (G)	250	98	99				10	507381
HEXAGON GT 250 4T (H)	250	98	99				10	507381
HEXAGON LX 125 (G)	125	98	99					
HEXAGON LX 125 (H)	125	98	99					
HEXAGON LXT 180 (G)	180	98	99					

				
Plaquettes arrière			Mâchoires arrière	
SEMI MÉTALLIQUES G1050	SEMI MÉTALLIQUES G1054	SINTERED G1380	N° Schéma	G2165
507127	507265		17	
507131	507268	507170	35	
507136	507273	507171	30	
507131	507268	507170	35	
507131	507268	507170	35	
507131	507268	507170	35	
507131	507268	507170	35	
507123	507259	507183	50	
507131	507268	507170	35	
	507369		185	
	507369		185	
507111	507328	507160	5	
507111	507328	507160	5	
507111	507328	507160	5	
507111	507328	507160	5	
507111	507328	507160	5	
507111	507328	507160	5	
507111	507328	507160	5	
507131	507268	507170	35	
507131	507268	507170	35	
507131	507268	507170	35	
507131	507268	507170	35	
507131	507268	507170	35	
507131	507268	507170	35	
507136	507273	507171	30	
507136	507273	507171	30	
507136	507273	507171	30	
507136	507273	507171	30	
507111	507328	507160	5	
507111	507328	507160	5	
507131	507268	507170	35	
507131	507268	507170	35	
507131	507268	507170	35	
507136	507273	507171	30	
507131	507268	507170	35	
507102	507239	507156	3	
507102	507239	507156	3	
		507181	37	
507131	507268	507170	35	
		507181	37	
507131	507268	507170	35	
		507181	37	

PLAQUETTES DE FREIN - MÂCHOIRES DE FREIN / BRAKE PADS - BRAKE SHOE

MOTEUR

CYCLE

PNEUMATIQUE

ATELIER

ACCESSOIRES

ÉLECTRICITÉ

FILTRATION

FREINAGE

TRANSMISSION

Modèle	Cylindre	Depuis	Jusqu'à	GALFER MOTO			GALFER MOTO	
				Plaquettes avant			Mâchoires avant	
				SEMI MÉTALLIQUES G1050	SEMI MÉTALLIQUES G1054	SINTERED G1380	N° Schéma	G2165
HEXAGON LXT 180 (H)	180	98	99					
LIBERTY	200	4						
LIBERTY 4T	125	98	8					
LIBERTY 4T	150	0						
LIBERTY 4T	125	9	14					
LIBERTY 4T ie	125	15						
SFERA 4T	125	96					19	507390
SKIPPER	125	93	97				19	507390
SKIPPER	150	93	97				19	507390
SKIPPER LX (G)	125	98	99					
SKIPPER LX (G)	150	98	99					
SKIPPER LX (H)	125	98	99					
SKIPPER LX (H)	150	98	99					
SKR 125 ST 4T (G)	125	0						
SKR 125 ST 4T (H)	125	0						
SKR 150 ST 4T (G)	150	0						
SKR 150 ST 4T (H)	150	0						
TYPHOON	125	95	95				17	507388
TYPHOON	125	96	10					
TYPHOON 4T	125							
VESPA ELETTRICA	EL	19						
VESPA ET4	125	96					19	507390
VESPA ET4	150	1					19	507390
VESPA IRIS/TX/ELESTAR	200	87						
VESPA LX 125 4T 3V	125	5					19	507390
VESPA LX 150 4T 3V	150	8					19	507390
VESPA PRIMAVERA	125	15					19	507390
VESPA PRIMAVERA ABS	125	17					19	507390
VESPA PRIMAVERA I-GET	125	23					19	507390
VESPA S 150	150	9					19	507390
VESPA SPRINT	125	15					19	507390
VESPA SPRINT SPORT ABS	125	17					19	507390
ZIP 125	125	0						
X EVO 400 LEFT/IZQ.	400	8						
X10 LEFT/IZQ	125	12						
X10 LEFT/IZQ	350	12						
X10 LEFT/IZQ	500	12						
X8 i.e.w. LEFT/IZQ.	400	6						
X9 EVOLUTION IZQ.	200	3						
X9 EVOLUTION LEFT/IZQ.	125	4	5					
X9 EVOLUTION LEFT/IZQ.	125	6						

PLAQUETTES DE FREIN - MÂCHOIRES DE FREIN / BRAKE PADS - BRAKE SHOE

MOTEUR

CYCLE

PNEUMATIQUE

ATELIER

ACCESSOIRES



ÉLECTRICITÉ

FILTRATION

FREINAGE

TRANSMISSION

Modèle	Cylindre	Depuis	Jusqu'à	GALFER MOTO Plaquettes avant			N° Schéma	Mâchoires avant G2165
				SEMI MÉTALLIQUES G1050	SEMI MÉTALLIQUES G1054	SINTERED G1380		
X9 EVOLUTION LEFT/IZQ.	250	4						
POCKETBIKE								
CALIPER POLINI								
POLARIS								
V 92 C	1500	0			507322			
V 92 SC	1500	0			507322			
POLARIS 4 WHEELS								
CYCLONE	250	86			507313			
HAWKEYE 300 2X4/4X4	300	6	6		507364			
POLINI								
XP 4 OFF ROAD	125	8		507118	507254			
XP 4 STREET 125	125	8		507118	507254			
PVM								
RACING CALIPER		90						
QINGQI COLOMBIA								
QMR 200 SP	200			507086	507223			
421 R SCOOTER	125							
QMR 200 ENDURO	200							
QMT 200 SUPERMOTARD	200							
REMMIX SCOOTER 125	125							
SUPRA 125 T10-E	125							
QJ MOTOR								
NX 150 X	150	22			507234	507180		
SRC 250	250	22			507234	507180		
SRK 125 S	125	22			507234	507180		
SRV 125	125	22			507234	507180		
TRX 12	125	22			507234	507180		
SRK 700	700	22			507320			
SRT 700	700	22			507320			
SVT 650 X	650	22			507320			
SRT 800	800	22		507116	507252	507164		
SRC 500	500	22		507142	507278	507174		
SRC 550	550	22		507142	507278	507174		
SRK 125	125	22		507142	507278	507174		
SRK 400	400	22		507142	507278	507174		
SRV 300	300	22		507142	507278	507174		
SRV 550	550	22		507142	507278	507174		
SRK 450 RC	450	22		507145	507282	507187		
RENAULT								
FULLTIME	125	2		507111	507328	507160		
FULLTIME	150	2		507111	507328	507160		
KOURANOS	125	2		507111	507328	507160		

 Plaquettes arrière			 Mâchoires arrière	
SEMI MÉTALLIQUES G1050	SEMI MÉTALLIQUES G1054	SINTERED G1380	N° Schéma	G2165
507131	507268	507170	35	
	507318		143	
	507324		149	
	507324		149	
			13	507384
	507364		180	
507118	507254		106	
507118	507254		106	
	507221		33	
507086	507223		9	
	507221		33	
	507221		33	
	507221		33	
507092	507229		69	
	507234	507180	90	
	507234	507180	90	
	507347		161	
	507199		83	
	507199		83	
	507199		83	
	507322		147	
	507347		161	
	507322		147	
	507322		147	
	507322		147	
507102	507239	507156	3	
507102	507239	507156	3	
507102	507239	507156	3	

PLAQUETTES DE FREIN - MÂCHOIRES DE FREIN / BRAKE PADS - BRAKE SHOE

MOTEUR

CYCLE

PNEUMATIQUE

ATELIER

ACCESSOIRES



ÉLECTRICITÉ

FILTRATION

FREINAGE

TRANSMISSION

Modèle	Cylindre	Depuis	Jusqu'à	GALFER MOTO Plaquettes avant			GALFER MOTO Mâchoires avant	
				SEMI MÉTALLIQUES G1050	SEMI MÉTALLIQUES G1054	SINTERED G1380	N° Schéma	G2165
KOURANOS	250	2		507111	507328	507160		
RIEJU								
MXR 125 4T	125	3		507077	507212	507151		
SMX 125	125	8		507077	507212	507151		
SMX 125 4T	125	3	7	507077	507212	507151		
TANGO 125	125	6	10	507077	507212	507151		
TANGO 125	125	11		507077	507212	507151		
TANGO 125 PRO	125	7		507077	507212	507151		
TANGO 250	250	11		507077	507212	507151		
TANGO OFF ROAD 250	250	9	11	507077	507212	507151		
TANGO ROAD 250	250	9	11	507077	507212	507151		
TANGO TRAIL 250	250	9	11	507077	507212	507151		
CENTURY 125	125	18		507081	507216			
RS-3	125	13		507081	507216			
RS-3 NKD	125	13		507081	507216			
MRX 250	250	6			507300			
MRX 450	450	5			507300			
NUUK CARGO 8.5	EL	18		507085	507222	507152		
NUUK TRACKER 8.5	EL	18		507085	507222	507152		
NUUK URBAN 8.5	EL	18		507085	507222	507152		
RS-2	125	6		507085	507222	507152		
RS-2 NKD	125	6		507085	507222	507152		
ADVENTURA LEGEND 500	500	22		507143	507230	507154		
CITY LINE 125 i.e.	125	14		507116	507252	507164		
CITY LINE 125 i.e. ABS	125	16		507116	507252	507164		
CITY LINE 300 i.e.	300	14		507116	507252	507164		
CITY LINE 300 i.e. ABS	300	16		507116	507252	507164		
MARATHON PRO 125	125	9		507124	507260			
MARATHON PRO 125 SM	125	9		507124	507260			
RS-3	125	10	12	507124	507260			
NKD 125	125	6		507129	507266	507168		
MR 200 RANGER	200	22			507356			
MR 250 PRO	250	22			507356			
MR 250 RACING	250	20			507356			
MR 300 PRO	300	20			507356			
MR 300 RACING	300	20			507356			
MR 300 RANGER	300	20			507356			
MR 300 SIX DAYS	300	22			507356			
MARATHON 250	250	9			507358			
MARATHON 450	450	9			507358			
MARATHON PRO 125 COMPETICION	125	11			507200			
PACIFIC	125	7						

 Plaquettes arrière			 Mâchoires arrière	
SEMI MÉTALLIQUES G1050	SEMI MÉTALLIQUES G1054	SINTERED G1380	N° Schéma	G2165
507102	507239	507156	3	
	507227	507153	39	
507116	507252	507164	14	
	507227	507153	39	
507116	507252	507164	14	
	507369		185	
507116	507252	507164	14	
	507369		185	
507116	507252	507164	14	
507116	507252	507164	14	
507116	507252	507164	14	
507137	507274		21	
507137	507274		21	
	507319		144	
	507319		144	
507134	507271		79	
507134	507271		79	
		507181	37	
		507181	37	
		507181	37	
		507181	37	
507116	507252	507164	14	
507116	507252	507164	14	
507137	507274		21	
507133	507270		29	
	507319		144	
	507319		144	
	507319		144	
	507319		144	
	507319		144	
	507319		144	
	507319		144	
507143	507230	507154	48	
507143	507230	507154	48	
	507369		185	
507086	507223		9	

PLAQUETTES DE FREIN - MÂCHOIRES DE FREIN / BRAKE PADS - BRAKE SHOE

MOTEUR

CYCLE

PNEUMATIQUE

ATELIER

ACCESSOIRES

ÉLECTRICITÉ

FILTRATION

FREINAGE

TRANSMISSION

Modèle	Cylindre	Depuis	Jusqu'à	GALFER MOTO			N° Schéma	Mâchoires avant
				SEMI MÉTALLIQUES G1050	SEMI MÉTALLIQUES G1054	SINTERED G1380		
ROXON 4 WHEELS								
RX 150	150	4		507085	507222	507152		
SPORT SPIRIT 150	150	4		507085	507222	507152		
ROYAL ENFIELD								
BULLET TRIALS WORK	500	20			507320			
CLASSIC 350	350	22			507320			
CLASSIC 500	500	20			507320			
CONTINENTAL GT 650	650	18			507320			
HIMALAYAN	500	20			507320			
INTERCEPTOR INT 650	650	18			507320			
METEOR 350	350	21			507320			
SCRAMBLER 500	500	20			507320			
THUNDERBIRD X	500	20			507320			
SUPER METEOR 650	650	22			507322			
BULLET CLASSIC (TODAS)	500	9						
CLUBMAN	500	9						
EFI	500	9						
EFI DE LUXE	500	9						
KIT ES	500	9						
TRAIL	500	9						
RPM								
PINZA RADIAL 4 PISTONES	DEL							
S.W.M.								
125 SI, S2	125	86		507074	507202			
250 PIONER	250	86		507074	507202			
250 SI, S2	250	86		507074	507202			
EXPLORER	250	86		507074	507202			
125 GP	125	86						
350 XP SAHARA	350	86						
SACHS								
b-805	800	3		507074	507202			
ROADSTER s-805	800	3		507074	507202			
TITAN 650	650	3		507074	507202			
MAD ASS 125	125	5		507086	507223			
X ROAD 125	125	4		507091	507228			
BEE 125	125	8						
SACHS 4 WHEELS								
4 ROCK 250	250	4		507107	507246	507158		
SANGLAS-YAMAHA								
400 Y	400	78		507074	507202			
SANYANG								
DUKE 125	125	94						

PLAQUETTES DE FREIN - MÂCHOIRES DE FREIN / BRAKE PADS - BRAKE SHOE

CGN
LE SENS DU DÉTAIL

MOTEUR

CYCLE

PNEUMATIQUE

ATELIER

ACCESSOIRES



ÉLECTRICITÉ

FILTRATION

FREINAGE

TRANSMISSION

Modèle	Cylindre	Depuis	Jusqu'à	GALFER MOTO Plaquettes avant			N° Schéma	Mâchoires avant G2165
				SEMI MÉTALLIQUES G1050	SEMI MÉTALLIQUES G1054	SINTERED G1380		
SCARABEO								
125 ie	125	15		507120	507256	507166		
SCOMADI								
LEGGERA TL 125	125	15						
LEGGERA TL 125 CHROME	125	15						
SCORPA								
2S5 WORKS	250	95		507077	507212	507151		
EASY RACE 280	280	99		507077	507212	507151		
ENDURO 2.5i	250	6			507300			
ENDURO 4.5i	450	6			507300			
ENDURO 5.1i	510	6			507300			
SY 125 F	125	5		507118	507254			
SY 175 F	175	5		507118	507254			
SY 250	250	5	5	507118	507254			
SY 250 F	250	6		507118	507254			
SY 250 FR	250	10		507118	507254			
TWENTY 125	125	15		507118	507254			
TWENTY 250	250	15		507118	507254			
TWENTY 300	300	15		507118	507254			
TY S 125 F	125	5		507118	507254			
TY S 175 F	175	6		507118	507254			
SY 250	250	0	4					
T-RIDE 125 F	125	10		507129	507266	507168		
T-RIDE 250 F	250	8						
SEAT								
MÓ 125	EL	21			507234	507180		
SHERCO								
1.25	125	99	1	507077	507212	507151		
2.0	200	99	5	507077	507212	507151		
2.5	250	99	1	507077	507212	507151		
2.9	290	99	0	507077	507212	507151		
CITYCORP 125	125	3		507077	507212	507151		
CITYCORP 125 SM	125	3		507077	507212	507151		
X-RIDE	290	13		507081	507216			
2.5 if	250	9			507300			
2.5 SEF-R ISDE	250	12			507300			
4.5 4T	450	4	8		507300			
4.5 4T SM	450	5	8		507300			
4.5 4T SM if	450	9			507300			
4.5 if	450	9			507300			
5.1 4T	510	6	8		507300			
5.1 if	510	9			507300			

 Plaquettes arrière			 Mâchoires arrière	
SEMI MÉTALLIQUES G1050	SEMI MÉTALLIQUES G1054	SINTERED G1380	N° Schéma	G2165
507123	507259	507183	50	
507108	507247	507159	34	
507108	507247	507159	34	
507077	507212	507151	6	
507077	507212	507151	6	
	507319		144	
	507319		144	
	507319		144	
	507343		157	
	507343		157	
	507343		157	
	507343		157	
	507343		157	
	507343		157	
	507343		157	
507077	507212	507151	6	
507077	507212	507151	6	
	507369		185	
	507369		185	
		519664	193	
	507227	507153	39	
507077	507212	507151	6	
507077	507212	507151	6	
507077	507212	507151	6	
	507227	507153	39	
	507227	507153	39	
507081	507216		23	
507143	507230	507154	48	
507143	507230	507154	48	
507143	507230	507154	48	
507078	507213		87	
	507347		161	
507143	507230	507154	48	
507143	507230	507154	48	
507143	507230	507154	48	

PLAQUETTES DE FREIN - MÂCHOIRES DE FREIN / BRAKE PADS - BRAKE SHOE

MOTEUR

CYCLE

PNEUMATIQUE

ATELIER

ACCESSOIRES

ÉLECTRICITÉ

FILTRATION



FREINAGE

TRANSMISSION

Modèle	Cylindre	Depuis	Jusqu'à	GALFER MOTO			GALFER MOTO	
				Plaquettes avant			Mâchoires avant	
				SEMI MÉTALLIQUES G1050	SEMI MÉTALLIQUES G1054	SINTERED G1380	N° Schéma	G2165
SE 3.0	300	10	11		507300			
SX 2.5 F	250	10			507300			
1.25	125	2	5	507118	507254			
125 ST	125	15		507118	507254			
2.5 02 Series	250	2	5	507118	507254			
2.9	290	1	5	507118	507254			
250 ST	250	15		507118	507254			
290 ST	290	15		507118	507254			
3.2 4T	320	5		507118	507254			
300 ST FACTORY	300	21		507118	507254			
300 ST FACTORY REPLICIA	300	21		507118	507254			
305 ST	305	15		507118	507254			
ST 1.25	125	6	12	507118	507254			
ST 1.25	125	13	14	507118	507254			
ST 2.0	200	6		507118	507254			
ST 2.5	250	6	12	507118	507254			
ST 2.5	250	13	14	507118	507254			
ST 2.9	290	6	11	507118	507254			
ST 2.9	290	12	14	507118	507254			
ST 3.0	300	13		507118	507254			
TY 125 ADVENTURE	125	21		507118	507254			
TY 125 LONG RIDE	125	21		507118	507254			
SE 1.25 F	125	10		507129	507266	507168		
SM 1.25 F	125	10		507129	507266	507168		
250 SE FACTORY	250	21			507358			
250 SE FORK SACHS	250	14			507358			
250 SE FORK WP	250	14			507358			
250 SE RACING	250	21			507358			
250 SEF FORK SACHS	250	14			507358			
250 SEF FORK WP	250	14			507358			
250 SEF-R FORK SACHS	250	14			507358			
250 SEF-R FORK WP	250	14			507358			
250 SE-R FORK SACHS	250	14			507358			
250 SE-R FORK WP	250	14			507358			
3.0 SEF-R ISDE	300	12			507358			
300 SE FORK SACHS	300	14			507358			
300 SE FORK WP	300	14			507358			
300 SEF FORK SACHS	300	14			507358			
300 SEF FORK WP	300	14			507358			
300 SEF-R FORK SACHS	300	14			507358			
300 SEF-R FORK WP	300	14			507358			
300 SE-R FORK SACHS	300	14			507358			

PLAQUETTES DE FREIN - MÂCHOIRES DE FREIN / BRAKE PADS - BRAKE SHOE

Modèle	Cylindre	Depuis	Jusqu'à	GALFER MOTO			N° Schéma	Mâchoires avant
				SEMI MÉTALLIQUES G1050	SEMI MÉTALLIQUES G1054	SINTERED G1380		
300 SE-R FORK WP	300	14			507358			
4.5 SEF-R ISDE	450	15			507358			
450 SEF FORK SACHS	450	15			507358			
450 SEF FORK WP	450	15			507358			
450 SEF-R FORK SACHS	450	15			507358			
450 SEF-R FORK WP	450	15			507358			
SE 125 FACTORY	125	21			507358			
SE 2.5i	250	12	13		507358			
SE 3.0i	300	12	13		507358			
SE 4.5i	450	12	13		507358			
SE 5.li	510	12	13		507358			
SE-R 2.5 ISDE	250	14			507358			
SE-R 3.0 ISDE	300	14			507358			
SIAMOTO								
CAPRI	125	99		507077	507212	507151		
CAPRI	180	99		507077	507212	507151		
FALKON	125	99		507077	507212	507151		
SIGMA COLOMBIA								
SG 150-6Y	150			507079	507214			
150-6Y	150							
SG 125-2A	125							
SG 125-4	125							
SG 125-5	125							
SG 150 TE	150							
SG 150-4	150							
SG 150-8	150							
SG 150-9	150							
SILENCE								
S02 DELIVERY	EL		19	507085	507222	507152		
S01	EL	20			507234	507180		
S01 PLUS	EL	20			507234	507180		
S02 DELIVERY	EL	20			507234	507180		
S02 DELIVERY	EL		19			519661		
SKYGO COLOMBIA								
SG 200-2	200			507104	507242	507157		
SG 125S	125							
STARK								
STARK VARG	EL	22			507358			
SUMCO								
125 KR	125	5		507077	507212	507151		
200 KR	200	5		507077	507212	507151		
KIRA KR 125 SM	125	6		507077	507212	507151		

				
Plaquettes arrière			Mâchoires arrière	
SEMI MÉTALLIQUES G1050	SEMI MÉTALLIQUES G1054	SINTERED G1380	N° Schéma	G2165
507143	507230	507154	48	
507143	507230	507154	48	
507143	507230	507154	48	
507143	507230	507154	48	
507143	507230	507154	48	
507143	507230	507154	48	
507143	507230	507154	48	
507143	507230	507154	48	
507143	507230	507154	48	
507143	507230	507154	48	
507143	507230	507154	48	
507143	507230	507154	48	
507143	507230	507154	48	
507143	507230	507154	48	
507143	507230	507154	48	
507077	507212	507151	6	
507077	507212	507151	6	
507077	507212	507151	6	
507115	507251	507163	66	
507079	507214		38	
507144	507281		74	
507124	507260		24	
507079	507214		38	
507144	507281		74	
507124	507260		24	
507079	507214		38	
		519661	190	
		519664	193	
		519664	193	
		519665	194	
		519661	190	
507079	507214		38	
507143	507230	507154	48	
		507181	37	
		507181	37	
		507181	37	

PLAQUETTES DE FREIN - MÂCHOIRES DE FREIN / BRAKE PADS - BRAKE SHOE

MOTEUR

CYCLE

PNEUMATIQUE

ATELIER

ACCESSOIRES

ÉLECTRICITÉ

FILTRATION

FREINAGE

TRANSMISSION

Modèle	Cylindre	Depuis	Jusqu'à	GALFER MOTO			GALFER MOTO	
				Plaquettes avant			Mâchoires avant	
				SEMI MÉTALLIQUES G1050	SEMI MÉTALLIQUES G1054	SINTERED G1380	N° Schéma	G2165
KIRA KR 125 TR	125	6		507077	507212	507151		
KIRA KR 200 TR	200	6		507077	507212	507151		
MS 125	125	6		507115	507251	507163		
MS 150	150	6		507115	507251	507163		
125 ST	125	5						
250 TWIN	250	5						
SUR RON								
STORMBEE HOMOLOGADA	EL	21			507355			
STORMBEE OFFROAD	EL	21			507355			
SUZUKI								
GN 400 L	400	80			507206			
GR 650 D, E, XD	650	83			507206			
GS 1000 EC, EN, HC, HN, S, SN	1000	82			507206			
GS 1000 G, GTL, L, LT	1000	80			507206			
GS 1000 SZ, EX	1000	82			507206			
GS 1100 ES, ESD, GD, GKD, GLD, SD	1100	83			507206			
GS 1100 ET, ST, T, LT	1100	80			507206			
GS 1100 EX, LX, TX, X	1100	81			507206			
GS 1100 GZ, GLZ, GKZ, GD, GLD	1100	82			507206			
GS 1100 L	1100	79			507206			
GS 500 M, MX	500	81			507206			
GS 550 B, DB, E	550	77	77		507206			
GS 550 E, L T, LX, TX	550	80	80		507206			
GS 550 EC, EN, LN	550	78	79		507206			
GS 550 ED, ESD	550	83			507206			
GS 550 ET, LTD.	550	80	80		507206			
GS 550 L2, M2	550	82	82		507206			
GS 550 ME, MX, KATANA	550	81	81		507206			
GS 650 EX, GLX, GX, X	650	81			507206			
GS 650 EZ, GLZ, GZ, GT	650	82			507206			
GS 650 GD, KATANA	650	83			507206			
GS 650 L	650	81			507206			
GS 650 MD	650	83			507206			
GS 650 TURBO, XN	650	83			507206			
GS 750 ED, ESD, ET, LT, FX, LX, T, X	750	80			507206			
GS 750 L, N, LN	750	79			507206			
GS 750 SD	750	83			507206			
GS 850 EN, GN, GT, G, GX, GLX	850	79			507206			
GS 850 TURBO	850	82			507206			
GSX 1000 S, KATANA	1000	82			507206			
GSX 1100 E, EZ, S, SZ, GK2	1100	82			507206			
GSX 1100 ET	1100	79			507206			

PLAQUETTES DE FREIN - MÂCHOIRES DE FREIN / BRAKE PADS - BRAKE SHOE

MOTEUR

CYCLE

PNEUMATIQUE

ATELIER

ACCESSOIRES



ÉLECTRICITÉ

FILTRATION

FREINAGE

TRANSMISSION

Modèle	Cylindre	Depuis	Jusqu'à	GALFER MOTO			GALFER MOTO	
				Plaquettes avant			Mâchoires avant	
				SEMI MÉTALLIQUES G1050	SEMI MÉTALLIQUES G1054	SINTERED G1380	N° Schéma	G2165
GSX 1100 G	1100	86	89		507206			
GSX 1100 G	1100	90	92		507206			
GSX 1100 KATANA	1100	82	88		507206			
GSX 250 E, ET, EX, LT, OX, TT, S	250	82	85		507206			
GSX 250 S	250	86			507206			
GSX 750 E, ET, ES, EX, EZ, LT, LX	750	80			507206			
GSX 750 S, KATANA	750	82			507206			
GSX 750 SZ	750	82			507206			
GV 1200 GLC	1200	86			507206			
GV 1400 CAVALCADE	1400	85	86		507206			
VS 1400 INTRUDER	1400	87	91		507206			
VX 800	800	90			507206			
ZX 800	800	92			507206			
GSX 400 FEZ, FED (four)	400	81						
BANDIT 250	250	90						
COBRA 250	250	89						
GS 400 E	400	91						
GS 400 F	400	89						
GS 500 E	500	89	95					
GSX 400 IMPULSE (Japan)	400	99						
GSX 400 IMPULSE (Japan)	400	94	98					
GSX 400 KATANA	400	89	91					
GSX 600 F	600	89	90					
GSX 600 FK	600	89						
GSX 600 R	600	92	96					
GSX 750 RR	750	89						
GSX R 400	400	90						
GSX R 400 R	400	90						
GSX R 750	750	88	90					
RF 400 R	400	93						
RGV 250 S	250	89	90					
WOLF 250	250	88						
DR 800 Z	800	89	89		507295			
LT 230 SF, S, R	230	85			507295			
RM 500 H	500	87			507295			
DR 125 SM	125	8			507300			
DR 250 SB	250	3			507300			
DR-Z 250 E	250	1			507300			
DR-Z 400 E	400	0			507300			
DR-Z 400 S	400	0			507300			
DR-Z 400 S SUPER MOTARD	400	5			507300			
RM 125	125	96	98		507300			

 Plaquettes arrière			 Mâchoires arrière	
SEMI MÉTALLIQUES G1050	SEMI MÉTALLIQUES G1054	SINTERED G1380	N° Schéma	G2165
	507299		124	
	507299		124	
	507299		124	
507081	507216		23	
	507299		124	
	507307		132	
	507299		124	
	507307		132	
	507299		124	
	507324		149	
507128	507167		44	
	507307		132	
	507308		133	
	507308		133	
	507303		128	
	507303		128	
	507299		124	
	507303		128	
	507303		128	
507128	507167		44	
	507303		128	
	507303		128	
	507304		129	
507081	507216		23	
	507221		33	
	507319		144	
	507319		144	
	507319		144	
	507319		144	
	507319		144	
	507319		144	
	507319		144	
	507319		144	

MOTEUR

CYCLE

PNEUMATIQUE

ATELIER

ACCESSOIRES

ÉLECTRICITÉ

FILTRATION

FREINAGE

TRANSMISSION

PLAQUETTES DE FREIN - MÂCHOIRES DE FREIN / BRAKE PADS - BRAKE SHOE

MOTEUR

CYCLE

PNEUMATIQUE

ATELIER

ACCESSOIRES



ÉLECTRICITÉ

FILTRATION

FREINAGE

TRANSMISSION

Modèle	Cylindre	Depuis	Jusqu'à	GALFER MOTO			GALFER MOTO	
				Plaquettes avant			Mâchoires avant	
				SEMI MÉTALLIQUES G1050	SEMI MÉTALLIQUES G1054	SINTERED G1380	N° Schéma	G2165
RM 125	125	99	3		507300			
RM 250	250	96	98		507300			
RM 250	250	99	3		507300			
RM 250	250	4	5		507300			
RM 250	250	6			507300			
SFV 400 GLADIUS RIGHT/DER	400	10			507305			
XF 650 FREEWIND	650	97			507305			
RGV 250 GAMMA	250	91	96		507306			
VL 1500 INTRUDER RIGHT/DER	1500	2			507307			
GOOSE 350	350	92			507309			
GS 500 E	500	96			507309			
GS 500 F	500	6			507309			
GSF 1200 BANDIT	1200	95	99		507309			
GSF 1200 BANDIT / S	1200	0	5		507309			
GSF 600 N BANDIT	600	95	99		507309			
GSF 600 N BANDIT IZQ.	600	0			507309			
GSX 1100 F	1100	89			507309			
GSX 1100 G	1100	93			507309			
GSX 1200	1200	99			507309			
GSX 1300 R HAYABUSA	1300	99	7		507309			
GSX 400 F BANDIT	400	90			507309			
GSX 400 INAZUMA	400	0			507309			
GSX 400 S KATANA	400	92			507309			
GSX 550 ET, EV	550	87			507309			
GSX 600 F	600	91	97		507309			
GSX 600 F IZQ. (KATANA 600 USA)	600	98	3		507309			
GSX 600 F IZQ. (KATANA 600 USA)	600	4			507309			
GSX 600 FJ	600	88			507309			
GSX 750 EF	750	87			507309			
GSX 750 F IZQ	750	98			507309			
GSX 750 F IZQ	750	3			507309			
GSX 750 F VS IZQ. (KATANA 750 USA)	750	99	2		507309			
GSX 750 F,FL	750	89	97		507309			
GSX 750 FK	750	89			507309			
GSX R 1100 W	1100	93			507309			
GSX R 1100, L, LM	1100	89	92		507309			
GSX R 400	400	89	89		507309			
GSX R 600 SRAD	600	97	3		507309			
GSX R 750 L, LM, W	750	91	93		507309			
GSX R 750 SRAD	750	0	3		507309			
GSX R 750 SRAD	750	96	99		507309			
GSX R 750 W	750	94	95		507309			

				
Plaquettes arrière			Mâchoires arrière	
SEMI MÉTALLIQUES G1050	SEMI MÉTALLIQUES G1054	SINTERED G1380	N° Schéma	G2165
	507319		144	
	507319		144	
	507319		144	
	507319		144	
	507319		144	
	507325		150	
	507325		150	
	507307		132	
	507325		150	
	507307		132	
	507325		150	
	507325		150	
	507303		128	
	507317		142	
507128	507167		44	
	507323		148	
	507308		133	
	507299		124	
	507324		149	
	507317		142	
	507299		124	
	507324		149	
	507307		132	
	507309		134	
	507308		133	
	507323		148	
	507323		148	
	507308		133	
	507323		148	
	507325		150	
	507323		148	
	507308		133	
	507308		133	
	507317		142	
	507303		128	
	507307		132	
	507307		132	
	507303		128	
	507307		132	
	507317		142	
	507317		142	

PLAQUETTES DE FREIN - MÂCHOIRES DE FREIN / BRAKE PADS - BRAKE SHOE

MOTEUR

CYCLE

PNEUMATIQUE

ATELIER

ACCESSOIRES



ÉLECTRICITÉ

FILTRATION

FREINAGE

TRANSMISSION

Modèle	Cylindre	Depuis	Jusqu'à	Plaquettes avant			N° Schéma	Mâchoires avant
				SEMI MÉTALLIQUES G1050	SEMI MÉTALLIQUES G1054	SINTERED G1380		
INAZUMA 1200	1200	98			507309			
RF 600 R	600	93			507309			
RG 200 GAMMA	200	92			507309			
RG 200 WOLF	200	92			507309			
RGV 250 GAMMA	250	89	90		507309			
RGV 250 R	250	88	88		507309			
SV 400 /S IZ.	400	99			507309			
SV 650 /S (LEFT)	650	99	2		507309			
TL 1000 R	1000	98			507309			
TL 1000 S	1000	97			507309			
TL 1600 S	1600	97			507309			
VS 1400 GLP	1400	92			507309			
DR 250 S	250	90	0		507310			
DR 350 S	350	90	92		507310			
DR 350 S, SH	350	93	93		507310			
DR 350 SE	350	94			507310			
DR 650	650	96			507310			
RM 125	125	89	95		507310			
RM 250	250	89	92		507310			
RM 250	250	93	95		507310			
RMX 250	250	95			507310			
RMX S	250	92	94		507310			
TS 125 R	125	90			507310			
TS 200 R	200	89			507310			
DR 800 S BIG	800	92		507088	507225			
DR 600 DJEBEL/DAKAR	600	89			507312			
DR 650 DJEBEL	650	90	90		507312			
DR 650 R, RS	650	90	91		507312			
DR 650 RE	650	94	95		507312			
DR 650 RL, RM, RSL	650	91	91		507312			
DR 650 RSE	650	92	93		507312			
DR 750 BIG	750	89	90		507312			
DR 800 S, SL BIG	800	90	91		507312			
RG 125 F	125	93	97		507312			
DL 1000 V-STROM (LEFT)	1000	1	13		507315			
DL 650 V-STROM (LEFT)	650	4	6		507315			
DL 650 V-STROM (LEFT)	650	7			507315			
DL 650 V-STROM ABS (LEFT)	650	7			507315			
DL 650 V-STROM XPEDITION (LEFT)	650	11			507315			
DL 650 V-STROM XPEDITION ABS (LEFT)	650	11	12		507315			
DL 650 V-STROM XPEDITION ABS (LEFT)	650	13	13		507315			

 Plaquettes arrière			 Mâchoires arrière	
SEMI MÉTALLIQUES G1050	SEMI MÉTALLIQUES G1054	SINTERED G1380	N° Schéma	G2165
	507324		149	
507128	507167		44	
	507307		132	
	507299		124	
	507307		132	
	507307		132	
	507323		148	
	507323		148	
	507317		142	
	507307		132	
	507307		132	
	507221		33	
	507221		33	
	507221		33	
	507221		33	
	507319		144	
	507221		33	
	507221		33	
	507221		33	
	507221		33	
	507221		33	
	507221		33	
	507221		33	
	507299		124	
	507304		129	
	507304		129	
	507304		129	
	507304		129	
	507304		129	
	507304		129	
	507307		132	
	507323		148	
	507323		148	
	507323		148	
	507323		148	
	507323		148	
	507323		148	
	507323		148	

PLAQUETTES DE FREIN - MÂCHOIRES DE FREIN / BRAKE PADS - BRAKE SHOE

MOTEUR

CYCLE

PNEUMATIQUE

ATELIER

ACCESSOIRES

ÉLECTRICITÉ

FILTRATION

FREINAGE

TRANSMISSION

Modèle	Cylindre	Depuis	Jusqu'à	GALFER MOTO			GALFER MOTO	
				Plaquettes avant			Mâchoires avant	
				SEMI MÉTALLIQUES G1050	SEMI MÉTALLIQUES G1054	SINTERED G1380	N° Schéma	G2165
DL 650 V-STROM XT ABS (LEFT)	650	15			507315			
GSF 1200 BANDIT / S	1200	6			507315			
GSF 1200 BANDIT ABS	1200	6			507315			
GSF 1250 BANDIT /SA	1250	10			507315			
GSF 1250 BANDIT A/S/SA	1250	7	8		507315			
GSF 1250 BANDIT FA	1250	9			507315			
GSF 650 BANDIT /S/	650	7			507315			
GSF 650 BANDIT /S/ ABS	650	7			507315			
GSF 650 BANDIT /S/ ABS IZQ.	650	6			507315			
GSR 750 ABS RIGHT/DER	750	11			507315			
GSR 750 RIGHT/DER	750	11			507315			
GSX 250 R	250	17			507315			
GSX 650 F	650	8			507315			
GSX 8S	800	23			507315			
GSX S 750	750	17			507315			
GSX-S 1000 ABS	1000	15			507315			
GSX-S 1000 F ABS	1000	15			507315			
GSX-S 1000 GT	1000	22			507315			
GSX-S 1000 KATANA	1000	19			507315			
GSX-S 1000 Y/Z	1000	21			507315			
GSX-S 950	950	21			507315			
SV 1000	1000	3			507315			
SV 1000 / S / SZ	1000	3			507315			
V STROM DE	800	23			507315			
GSX 250 FX	250	2			507321			
INTRUDER C 1800 R	1800	8	11		507325			
INTRUDER C 1800 RT	1800	8	9		507325			
M 109 R BOULEVARD	1800	6			507325			
M 1500 RIGHT/DER	1500	9			507325			
M 1800 RB	1800	14			507325			
VL 1500 INTRUDER T	1500	13			507325			
VZ 1600	1600	4			507325			
VZ 1600 INTRUDER	1600	5			507325			
VZR 1800 INTRUDER	1800	6	7		507325			
VZR 1800 INTRUDER	1800	8			507325			
RF 900 R	900	94	95					
RF 900 RS2	900	96						
UH 125 BURGMAN	125	2	6	507116	507252	507164		
UH 150 BURGMAN	150	2		507116	507252	507164		
GS 1200 SS	1200	1			507349			
GSF 650 BANDIT /S IZQ.	650	5	5		507349			
GSX 1100 KATANA	1100	2			507349			

GALFER MOTO			GALFER MOTO	
Plaquettes arrière			Mâchoires arrière	
SEMI MÉTALLIQUES G1050	SEMI MÉTALLIQUES G1054	SINTERED G1380	N° Schéma	G2165
	507323		148	
	507307		132	
	507307		132	
	507307		132	
	507307		132	
	507307		132	
	507307		132	
	507307		132	
	507323		148	
	507325		150	
	507325		150	
507128	507167		44	
	507307		132	
	507362		178	
	507362		178	
	507205		175	
	507307		132	
	507307		132	
507128	507167		44	
	507325		150	
507140	507277	507173	54	
507140	507277	507173	54	
	507205		175	
	507325		150	
	507205		175	
507094	507231		46	
	507317		142	
	507357		169	
	507205		175	
507140	507277	507173	54	
	507303		128	
	507303		128	
507143	507230	507154	48	
507143	507230	507154	48	
	507317		142	
	507323		148	
	507317		142	

PLAQUETTES DE FREIN - MÂCHOIRES DE FREIN / BRAKE PADS - BRAKE SHOE

MOTEUR

CYCLE

PNEUMATIQUE

ATELIER

ACCESSOIRES



ÉLECTRICITÉ

FILTRATION

FREINAGE

TRANSMISSION

Modèle	Cylindre	Depuis	Jusqu'à	GALFER MOTO			Plaquettes avant		GALFER MOTO	
				SEMI MÉTALLIQUES G1050	SEMI MÉTALLIQUES G1054	SINTERED G1380	N° Schéma	Mâchoires avant G2165		
GSX 1400	1400	1			507349					
GSX R 1000	1000	1	2		507349					
GSX R 1000	1000	3	3		507349					
GSX R 1000	1000	4	4		507349					
GSX R 1000	1000	5	6		507349					
GSX R 600 SRAD	600	4	5		507349					
GSX R 750 SRAD	750	4	5		507349					
RM 125	125	4	5		507356					
RM 125	125	6			507356					
RM 250 Z	250	4	6		507356					
RM 250 Z	250	7	12		507356					
RM 250 Z	250	13	18		507356					
RM 250 Z	250	19			507356					
RM 450 Z	450	5			507356					
RMX 450 Z	450	10	17		507356					
RMX 450 Z	450	18			507356					
RM 125	125	88	88		507360					
RM 250	250	87	88		507360					
SIXTEEN	125	8		507135	507272					
SIXTEEN	150	8		507135	507272					
UH 125 BURGMAN	125	14		507135	507272					
UH 125 BURGMAN	125	7	13	507135	507272					
UH 125 BURGMAN ABS	125	14		507135	507272					
UH 125 BURGMAN R	125	11		507135	507272					
UH 200 BURGMAN	200	14		507135	507272					
UH 200 BURGMAN	200	7	13	507135	507272					
UH 200 BURGMAN ABS	200	14		507135	507272					
B-KING	1300	7			507365					
DL 1000 V-STROM ABS	1000	14			507365					
DL 1000 V-STROM XT ABS	1000	17			507365					
DL 1050 V-STROM	1050	20			507365					
DL 1050 V-STROM XT	1050	20			507365					
GSR 400	400	6			507365					
GSR 600	600	6			507365					
GSX 1300 R HAYABUSA	1300	8	13		507365					
GSX 1300 R HAYABUSA	1300	14	20		507365					
GSX 1300 R HAYABUSA	1300	21			507365					
GSX R 1000	1000	7	8		507365					
GSX R 600	600	6	7		507365					
GSX R 600	600	8	10		507365					
GSX R 750	750	6	7		507365					
GSX R 750	750	8	10		507365					

 Plaquettes arrière			 Mâchoires arrière	
SEMI MÉTALLIQUES G1050	SEMI MÉTALLIQUES G1054	SINTERED G1380	N° Schéma	G2165
	507317		142	
	507317		142	
	507357		169	
	507205		175	
	507205		175	
	507205		175	
	507205		175	
	507319		144	
	507319		144	
	507319		144	
	507319		144	
	507319		144	
	507319		144	
	507319		144	
	507319		144	
	507221		33	
	507221		33	
507140	507277	507173	54	
507140	507277	507173	54	
507088	507225		31	
507140	507277	507173	54	
507088	507225		31	
507140	507277	507173	54	
507088	507225		31	
507140	507277	507173	54	
507088	507225		31	
	507362		178	
	507205		175	
	507205		175	
	507205		175	
	507205		175	
	507307		132	
	507307		132	
	507205		175	
	507205		175	
	507205		175	
	507205		175	
	507205		175	
	507205		175	

PLAQUETTES DE FREIN - MÂCHOIRES DE FREIN / BRAKE PADS - BRAKE SHOE

CGN
LE SENS DU DÉTAIL

MOTEUR

CYCLE

PNEUMATIQUE

ATELIER

ACCESSOIRES



ÉLECTRICITÉ

FILTRATION

FREINAGE



TRANSMISSION

Modèle	Cylindre	Depuis	Jusqu'à	GALFER MOTO			GALFER MOTO	
				Plaquettes avant			Mâchoires avant	
				SEMI MÉTALLIQUES G1050	SEMI MÉTALLIQUES G1054	SINTERED G1380	N° Schéma	G2165
GSX R 1000	1000	9	11		507366			
GSX R 1000	1000	12	15		507366			
GSX R 1000	1000	16			507366			
GSX R 1000 R	1000	16			507366			
GSX R 600	600	11			507366			
GSX R 750	750	11			507366			
AN 250 BURGMAN	250	98	2		507283	507188		
AN 250 BURGMAN	250	3	6		507283	507188		
AN 250 BURGMAN / SKY WAVE IZQ.	250	7	8		507283	507188		
AN 400 BURGMAN	400	98	2		507283	507188		
AN 400 BURGMAN	400	3	5		507283	507188		
CK SKY WAVE 400	400	3			507283	507188		
AN 400 BURGMAN DER./RIGHT	400	6			507284	507189		
AN 400 SKY WAVE DER./RIGHT	400	7			507284	507189		
AN 650 BURGMAN	650	2	3		507284	507189		
AN 650 BURGMAN	650	4	12		507284	507189		
AN 650 BURGMAN	650	13			507284	507189		
CJ 250 SKY WAVE / Type S	250	3			507284	507189		
CP SKY WAVE 650	650	3	3		507284	507189		
CP SKY WAVE 650	650	4			507284	507189		
GEMMA 250 (JAP)	250	9			507284	507189		
GW 250 INAZUMA	250	12	14		507371			
GW 250 INAZUMA F	250	15			507371			
GW 250 INAZUMA S	250	13	14		507371			
GW 250 INAZUMA Z	250	15			507371			
SFV 650 GLADIUS (RIGHT)	650	9			507371			
SFV 650 GLADIUS ABS (RIGHT)	650	10			507371			
SV 650	650	19			507371			
SV 650 /S (LEFT)	650	3	3		507371			
SV 650 /S (LEFT)	650	4	6		507371			
SV 650 ABS (LEFT)	650	7			507371			
SV 650 X (LEFT)	650	18			507371			
V-STROM 250	250	17			507371			
GSX R 125	125	17						
GSX S 125	125	17						
ADDRESS 125	125	9	20					
ADDRESS 125	125	21						
AN VECSTAR	125	95					9	507380
AN VECSTAR	150	98					9	507380
AVENIS 125	125	22						
AVENIS 150	150	99						
BOULEVARD 400	400	5						

				
Plaquettes arrière			Mâchoires arrière	
SEMI MÉTALLIQUES G1050	SEMI MÉTALLIQUES G1054	SINTERED G1380	N° Schéma	G2165
	507205		175	
507117	507253	507165	13	
507117	507253	507165	13	
507107	507246	507158	102	
507117	507253	507165	13	
507117	507253	507165	13	
507117	507253	507165	13	
	507234	507180	90	
	507234	507180	90	
507128	507167		44	
507128	507167		44	
507128	507167		44	
507117	507253	507165	13	
507128	507167		44	
507128	507167		44	
507094	507231		46	
507128	507167		44	
507128	507167		44	
507128	507167		44	
507128	507167		44	
	507325		150	
	507325		150	
	507307		132	
	507323		148	
	507323		148	
	507323		148	
	507323		148	
507128	507167		44	
507134	507271		79	
507134	507271		79	
507088	507225		31	
		519662	186	
507106			101	
507106			101	
		519662	186	
507106			101	
	507325		150	



PLAQUETTES DE FREIN - MÂCHOIRES DE FREIN / BRAKE PADS - BRAKE SHOE

Modèle	Cylindre	Depuis	Jusqu'à	GALFER MOTO			N° Schéma	Mâchoires avant G2165
				Plaquettes avant				
				SEMI MÉTALLIQUES G1050	SEMI MÉTALLIQUES G1054	SINTERED G1380		
BOULEVARD 800	800	5						
DESERT EXPRESS	750	88	90					
DR 125 G,H,J	125	88					8	507379
DR 125 S	125	93	97				8	507379
DR 125 S	125	86	92				8	507379
DR 125 S	125	98					8	507379
DR 125 SE	125	94					8	507379
DR 200	200	86	88				8	507379
DR 200 K	200	89					8	507379
DR 250 S	250	86	89				8	507379
DR 600 DJEBEL	600	88	89				8	507379
DR 600 PARIS DAKAR	600	87	89				8	507379
DR 600 RH	600	87	89				8	507379
DR 600 S	600	85	86				8	507379
DR 600 SN	600	87	89				8	507379
DR 750 BIG	750	88	90					
DR-Z 125 L	125	3						
EN 125	125	5					8	507379
EPICURO 125	125	99						
EPICURO 150	150	99						
GN 125	125	93					8	507379
GN 250	250	93					8	507379
GN 250 F, J	250	88	92				8	507379
GS 125 ESZ	125	82					8	507379
GS 450 S	450	87						
GT 125 A, B, C, EC, L, MK	125	77					8	507379
GT 125 C, E, EC, H	125	78					8	507379
GT 125 ET, T	125	80					8	507379
GT 200	200	79					8	507379
GZ 125 MARAUDER	125	98						
GZ 250 MARAUDER	250	98	7					
GZ 250 MARAUDER	250	8						
INTRUDER LC 250	250	0						
LS 650 (S40 BOULEVAR USA)	650	5	8					
LS 650 (S40 BOULEVAR USA)	650	9						
LS 650 P	650	92	4					
LS 650 SAVAGE	650	87	87					
LS 650 SAVAGE	650	90	91					
LT 500 R	500	88						
RG 125	125	79	86				8	507379
RG 125 GAMMA	125	87	92				8	507379
RG 125 WF GAMMA	125	85	86				8	507379

				
Plaquettes arrière			Mâchoires arrière	
SEMI MÉTALLIQUES G1050	SEMI MÉTALLIQUES G1054	SINTERED G1380	N° Schéma	G2165
	507325		150	
	507304		129	
507086	507223		9	
	507295		120	
507086	507223		9	
507086	507223		9	
	507295		120	
507086	507223		9	
507086	507223		9	
507086	507223		9	
	507304		129	
507106			101	
	507221		33	
507106			101	
507106			101	
507081	507216		23	
507081	507216		23	
507081	507216		23	
507081	507216		23	
507114	507250		105	
507114	507250		105	
507114	507250		105	
507114	507250		105	
507114	507250		105	
507114	507250		105	
507114	507250		105	
507114	507250		105	
507114	507250		105	
507114	507250		105	
507085	507222	507152	25	
507081	507216		23	

PLAQUETTES DE FREIN - MÂCHOIRES DE FREIN / BRAKE PADS - BRAKE SHOE

Modèle	Cylindre	Depuis	Jusqu'à	GALFER MOTO			N° Schéma	Mâchoires avant G2165
				Plaquettes avant				
				SEMI MÉTALLIQUES G1050	SEMI MÉTALLIQUES G1054	SINTERED G1380		
RG 185	185	75					8	507379
RGV 125 WATER COOLED	125	98						
RH 125 X	125	87					8	507379
RH 240 X	240	87						
RH 250	250	85						
RM 125	125	87	87					
RM 500 F	500	85	86				8	507379
RV 125 VAN VAN	125	3						
RV 200 VAN VAN	200	3						
SHOGUN R	125	5						
SP 200 G, H, J	200	88						
TR 125	125	83						
TS 125 R	125	89	89					
TS 125 X	125	88						
TS 125 X	125	86	87					
TS 240 X	240	88						
TS 250 X, EXR	250	85						
TU 125	125	0					8	507379
TU 250 GRASSTRACKER/BIG BOY	250	0						
TU 250 X	250	2					8	507379
TU 250 X	250	97	1				8	507379
UE 125	125	1						
UH 125 BURGMAN STREET EX	125	22						
VL 125 MARAUDER	125	0						
VL 1800 VOLUSIA	1800	2						
VL 250 MARAUDER	250	0						
VL 800 VOLUSIA	800	1						
VS INTRUDER M 800	800	5						
VZ 800 MARAUDER	800	97						
X4 125	125	82						
AN 250 BURGMAN / SKY WAVE DER.	250	7	8					
AN 400 BURGMAN IZQ./LEFT	400	6						
AN 400 SKY WAVE IZQ./LEFT	400	7						
DL 1000 V-STROM (RIGHT)	1000	1	13					
DL 650 V-STROM (RIGHT)	650	4	6					
DL 650 V-STROM (RIGHT)	650	7						
DL 650 V-STROM ABS (RIGHT)	650	7						
DL 650 V-STROM XPEDITION (RIGHT)	650	11						
DL 650 V-STROM XPEDITION ABS (RIGHT)	650	11	12					
DL 650 V-STROM XPEDITION ABS (RIGHT)	650	13	13					
DL 650 V-STROM XT ABS (RIGHT)	650	15						

 Plaquettes arrière			 Mâchoires arrière	
SEMI MÉTALLIQUES G1050	SEMI MÉTALLIQUES G1054	SINTERED G1380	N° Schéma	G2165
507088	507225		31	
507086	507223		9	
507086	507223		9	
507086	507223		9	
	507221		33	
	507325		150	
	507325		150	
	507234	507180	90	
507086	507223		9	
507081	507216		23	
	507295		120	
	507295		120	
507086	507223		9	
	507295		120	
507086	507223		9	
507114	507250		105	
	507323		148	
	507323		148	
507114	507250		105	
507085	507222	507152	25	
		519662	186	
507114	507250		105	
	507325		150	
507114	507250		105	
	507325		150	
	507325		150	
	507325		150	
507081	507216		23	
	507234	507180	90	
507107	507246	507158	102	
507107	507246	507158	102	
	507325		150	
	507325		150	
	507325		150	
	507325		150	
	507325		150	
	507325		150	
	507325		150	
	507325		150	
	507325		150	
	507325		150	

PLAQUETTES DE FREIN - MÂCHOIRES DE FREIN / BRAKE PADS - BRAKE SHOE

MOTEUR

CYCLE

PNEUMATIQUE

ATELIER

ACCESSOIRES



ÉLECTRICITÉ

FILTRATION

FREINAGE



TRANSMISSION

Modèle	Cylindre	Depuis	Jusqu'à	GALFER MOTO			GALFER MOTO	
				Plaquettes avant			Mâchoires avant	
				SEMI MÉTALLIQUES G1050	SEMI MÉTALLIQUES G1054	SINTERED G1380	N° Schéma	G2165
GSF 600 N BANDIT DER.	600	0						
GSF 650 BANDIT /S DER.	650	5	5					
GSF 650 BANDIT /S/ ABS DER.	650	6						
GSR 750 ABS LEFT/IZQ	750	11						
GSR 750 LEFT/IZQ	750	11						
GSX 600 F DER. (KATANA 600 USA)	600	98	3					
GSX 600 F DER. (KATANA 600 USA)	600	4						
GSX 750 F DER.	750	3						
GSX 750 F DER.	750	98						
GSX 750 F VS DER. (KATANA 750 USA)	750	99	2					
M 1500 LEFT/IZQ	1500	9						
SFV 400 GLADIUS LEFT/IZQ	400	10						
SFV 650 GLADIUS (LEFT)	650	9						
SFV 650 GLADIUS ABS (LEFT)	650	10						
SV 400 /S DER.	400	99						
SV 650 /S (RIGHT)	650	99	2					
SV 650 /S (RIGHT)	650	3	3					
SV 650 /S (RIGHT)	650	4	6					
SV 650 ABS (RIGHT)	650	7						
SV 650 X (RIGHT)	650	18						
VL 1500 INTRUDER LEFT/IZQ	1500	2						
SUZUKI 4 WHEELS								
LT F 500 VINSON	500	9						
LT 230 EH,EJ,EK,EL,EM,EN,EP	230	86	93		507295			
LT 230 SF/SG/SH/SJ	230	85	88		507295			
LT 250 RF QUADRACER	250	85	85		507295			
LT 250 RF, RG, RH	250	85	85		507295			
LT 250 RF/ RG/ RH	250	85	87		507295			
LT 250 RG	250	86	87		507295			
LT 250 RJ, RK, RL	250	88			507295			
LT 250 RJ/ RK/ RL/ RM/ RN	250	88	92		507295			
LT R 450 RIGHT/DER.	450	6			507295			
LT Z 400	400	3			507295			
LT 250 SK/SL	250	89	90					
LT-F/A 500 F QUADRUNNER LEFT/ IZQ.	500	98	2		507204			
LT 250 F OZARK	250	2						
LT A 400 DER. KING QUAD	400	8						
LT A 400 IZQ. KING QUAD	400	8						
LT A-400	400	2						
LT F 400 DER. KING QUAD	400	8						
LT F 400 IZQ. KING QUAD	400	8						

				
Plaquettes arrière			Mâchoires arrière	
SEMI MÉTALLIQUES G1050	SEMI MÉTALLIQUES G1054	SINTERED G1380	N° Schéma	G2165
	507325		150	
	507325		150	
	507325		150	
	507323		148	
	507323		148	
	507325		150	
	507325		150	
	507323		148	
	507325		150	
	507325		150	
	507323		148	
	507323		148	
	507323		148	
	507323		148	
	507325		150	
	507325		150	
	507325		150	
	507325		150	
	507325		150	
	507325		150	
	507323		148	
507086	507223		9	
507081	507216		23	
507081	507216		23	
507081	507216		23	
507091	507228		22	
507081	507216		23	
507081	507216		23	
507081	507216		23	
507081	507216		23	
507088	507225		31	
	507295		120	
507081	507216		23	
	507221		33	
507086	507223		9	
507135	507272		77	
	507204		174	
507086	507223		9	
507135	507272		77	
	507204		174	

PLAQUETTES DE FREIN - MÂCHOIRES DE FREIN / BRAKE PADS - BRAKE SHOE

Modèle	Cylindre	Depuis	Jusqu'à	GALFER MOTO			N° Schéma	Mâchoires avant
				SEMI MÉTALLIQUES G1050	SEMI MÉTALLIQUES G1054	SINTERED G1380		
LT Z-250 K4 QUAD SPORT	250	4						
LT-A 700 KING QUAD RIGHT/DER.	700	5						
LTF 300 DER.	300	2						
LTF 300 IZQ.	300	2						
LTF 400 EGER	400	2	7					
LT 500 RH,RJ,RK,RL,RM,RN	500	91	93					
LT R 450 LEFT/IZQ.	450	6						
LT-A 700 KING QUAD LEFT/IZQ.	700	5						
LT-F/A 500 F QUADRUNNER RIGHT/ DER.	500	98	2					
SUZUKI COLOMBIA								
FD125 BEST	125							
GS 125	125							
GS 150	150							
GSX 125	125							
GSX 150	150							
STEP 125	125							
VOLTY 250	250							
SUZUKI INDONESIA								
SATRIA F 150	150	11		507125	507261			
SHOGUN AXELO 125	125	12		507125	507261			
SHOGUN AXELO R 125	125	12		507125	507261			
SHOGUN AXELO S 125	125	12		507125	507261			
SHOGUN AXELO SE 125	125	12		507125	507261			
SHOGUN FD 125	125	9		507125	507261			
SHOGUN FI 125	125	9		507125	507261			
SHOGUN RR 125	125	9		507125	507261			
SHOGUN SPI25	125	9		507125	507261			
ARASHI 125	125	10						
SHOGUN 125	125	9						
SKYDRIVE DYNAMIC	125	12						
SKYDRIVE SPECIAL EDITION	125	12						
SKYWAVE 125	125	10						
SPIN 125	125	10						
THUNDER 125	125	10						
SUZUKI MALASIA								
BELANG R 150	150	11		507125	507261			
SHOGUN AXELO 125	125	12		507125	507261			
SHOGUN RR 125	125	9		507125	507261			
SHOGUN SPI25	125	9		507125	507261			
SKYDRIVE	125	12						
SKYDRIVE SPECIAL EDITION	125	12						

 Plaquettes arrière			 Mâchoires arrière	
SEMI MÉTALLIQUES G1050	SEMI MÉTALLIQUES G1054	SINTERED G1380	N° Schéma	G2165
507086	507223		9	
	507204		174	
507088	507225		31	
	507221		33	
507086	507223		9	
507081	507216		23	
	507221		33	
507135	507272		77	
507088	507225		31	
507088	507225		31	
507107	507246	507158	102	
	507221		33	
507107	507246	507158	102	
507107	507246	507158	102	
507125	507261		51	
	507323		148	
507088	507225		31	
507088	507225		31	
507088	507225		31	
507088	507225		31	
507088	507225		31	
507088	507225		31	
507088	507225		31	
507125	507261		51	
507125	507261		51	
507088	507225		31	
507125	507261		51	
	507221		33	
507088	507225		31	
507088	507225		31	
507088	507225		31	
507125	507261		51	
507125	507261		51	

PLAQUETTES DE FREIN - MÂCHOIRES DE FREIN / BRAKE PADS - BRAKE SHOE

MOTEUR

CYCLE

PNEUMATIQUE

ATELIER

ACCESSOIRES



ÉLECTRICITÉ

FILTRATION

FREINAGE

TRANSMISSION

Modèle	Cylindre	Depuis	Jusqu'à	GALFER MOTO			N° Schéma	Mâchoires avant G2165
				Plaquettes avant				
				SEMI MÉTALLIQUES G1050	SEMI MÉTALLIQUES G1054	SINTERED G1380		
SWM								
ACE OF SPADES	500	20			507320			
GRAN MILANO	440	16			507320			
GRAN TURISMO	440	15			507320			
OUTLAW	500	20			507320			
RS 650 R	650	16			507320			
SILVER VASE	440	16			507320			
SM 125 R	125	16			507320			
SM 650 R	650	16			507320			
SUPER DUAL	650	16			507320			
SUPER DUAL GT	650	16			507320			
V4 REZ 400	400	20			507320			
FT 300 R	300	16			507358			
MC 250 S	250	16			507358			
MC 650 R	650	18			507358			
RS 125 R	125	16			507358			
RS 300 R	300	16			507358			
RS 500 R	500	16			507358			
SM 450 R	450	15			507358			
SM 500 R	500	16			507358			
SYM								
SYMHT 125	125	19		507081	507216			
SYMHX 125	125	19		507081	507216			
RS 125	125	4			507234	507180		
RS 150	150	6			507234	507180		
CITYCOM 300 i	300	8		507108	507247	507159		
DRG 160i	160	20		507111	507328	507160		
JET 14	125	18		507111	507328	507160		
JET X	125	22		507111	507328	507160		
SYMPHONY 125 S	125	10		507111	507328	507160		
SYMPHONY 125 SR	125	10		507111	507328	507160		
SYMPHONY 125 ST	125	16		507111	507328	507160		
SYMPHONY ST 200i CBS	200	16		507111	507328	507160		
GT 500	500	5		507126	507264			
JOYRIDE	125	1		507126	507264			
JOYRIDE	150	1		507126	507264			
JOYRIDE	200	1		507126	507264			
JOYRIDE 200i EVO	200	13		507126	507264			
VOYAGER 250	250	5			507359			
SB 125 WOLF	125	11			507363			
VF 185	185	19			507363			
WOLF SB 125 Ni	125	15			507363			

 Plaquettes arrière			 Mâchoires arrière	
SEMI MÉTALLIQUES G1050	SEMI MÉTALLIQUES G1054	SINTERED G1380	N° Schéma	G2165
	507347		161	
	507347		161	
507128	507167		44	
	507347		161	
507143	507230	507154	48	
	507322		147	
	507322		147	
	507347		161	
	507322		147	
	507322		147	
	507199		83	
507143	507230	507154	48	
507143	507230	507154	48	
507143	507230	507154	48	
507143	507230	507154	48	
507143	507230	507154	48	
507143	507230	507154	48	
	507347		161	
	507347		161	
	507221		33	
	507221		33	
		507190	40	
		507190	40	
507108	507247	507159	34	
507108	507247	507159	34	
507108	507247	507159	34	
507108	507247	507159	34	
507108	507247	507159	34	
507108	507247	507159	34	
507108	507247	507159	34	
507108	507247	507159	34	
507117	507253	507165	13	
		507190	40	
		507190	40	
		507190	40	
		507190	40	
507130	507267	507169	78	
507145	507282	507187	11	
507079	507214		38	
507145	507282	507187	11	

PLAQUETTES DE FREIN - MÂCHOIRES DE FREIN / BRAKE PADS - BRAKE SHOE

CGN
LE SENS DU DÉTAIL

MOTEUR

CYCLE

PNEUMATIQUE

ATELIER

ACCESSOIRES



ÉLECTRICITÉ

FILTRATION

FREINAGE



TRANSMISSION

Modèle	Cylindre	Depuis	Jusqu'à	GALFER MOTO			N° Schéma	Mâchoires avant
				SEMI MÉTALLIQUES G1050	SEMI MÉTALLIQUES G1054	SINTERED G1380		
WOLF SB 250 Ni	250	15			507363			
WOLF SB 300	300	15			507363			
WOLF SB 300 CR	300	15			507363			
CITYCOM 125	125	9		507145	507282	507187		
CRUISYM 125	125	18		507145	507282	507187		
CRUISYM 300	300	18		507145	507282	507187		
GTS 125	125	7		507145	507282	507187		
GTS 250	250	7		507145	507282	507187		
H 200 SE	200	6		507145	507282	507187		
HD 125 EVO	125	6		507145	507282	507187		
HD 2 125 CBS	125	15		507145	507282	507187		
HD 200 S EVO	200	6		507145	507282	507187		
JOYMAX 125	125	15		507145	507282	507187		
JOYMAX 250 i	250	7		507145	507282	507187		
JOYMAX 250 i	250	7		507145	507282	507187		
JOYMAX 300 i EVO	300	9		507145	507282	507187		
MAX SYM 400i	400	11				507194		
MAX SYM 400i ABS	400	14				507194		
MAX SYM 600i ABS	600	15				507194		
MAX SYM 600i SPORT ABS	600	15				507194		
MAX SYM TL 1	400	18				507194		
ALLO 125	125	15						
ATTILA	125	99						
B9A 125	125	10						
CEVALO 125	125	10						
EURO MX	125	2						
EURO MX	150	2						
EURO MX DD	125	6						
EVIE	EL	10						507373
FIDDLE 125	125	8						
FIDDLE III 125	125	15						
FNX 125	125	18						
HUSKY	125	99						
HUSKY ADV	150	22						
JET 4	125	10						
MEGALO	125	2						
NEW DUKE	125	2						
SHARK 125	125	99						
SUPER DUKE	125	99						
SYMMETRY	EL	11						507373
SYMPHONY 125	125	9						
SYMPPLY 125	125	7						

				
Plaquettes arrière			Mâchoires arrière	
SEMI MÉTALLIQUES G1050	SEMI MÉTALLIQUES G1054	SINTERED G1380	N° Schéma	G2165
		507193	113	
507145	507282	507187	11	
507145	507282	507187	11	
507108	507247	507159	34	
507130	507267	507169	78	
507130	507267	507169	78	
507145	507282	507187	11	
507117	507253	507165	13	
507108	507247	507159	34	
507108	507247	507159	34	
507108	507247	507159	34	
507108	507247	507159	34	
507130	507267	507169	78	
507130	507267	507169	78	
507130	507267	507169	78	
507130	507267	507169	78	
		507193	113	
		507193	113	
		507193	113	
		507193	113	
		507193	113	
507108	507247	507159	34	
507108	507247	507159	34	
507145	507282	507187	11	
507145	507282	507187	11	
		507190	40	
		507190	40	
		507190	40	
			2	507373
507108	507247	507159	34	
507108	507247	507159	34	
507108	507247	507159	34	
		507190	40	
		507190	40	
507108	507247	507159	34	
507108	507247	507159	34	
507108	507247	507159	34	
		507190	40	
507108	507247	507159	34	
			2	507373
507108	507247	507159	34	
507108	507247	507159	34	

PLAQUETTES DE FREIN - MÂCHOIRES DE FREIN / BRAKE PADS - BRAKE SHOE

Modèle	Cylindre	Depuis	Jusqu'à	GALFER MOTO Plaquettes avant			N° Schéma	Mâchoires avant G2165
				SEMI MÉTALLIQUES G1050	SEMI MÉTALLIQUES G1054	SINTERED G1380		
VS 125	125	6						
VS 150	150	6						
WOLF LEGEND	125	2						
WOO	EL	11						507373
X PRO 125	125	13						
XS 125 K	125	7						
SYM 4 WHEELS								
QUADLANDER 250	250	5			507363			
QUADRAIDER 600	600	6	9		507363			
QUADRAIDER 600 LE	600	10			507363			
CITYMAX 300	300	6		507145	507282	507187		
TRACKRUNNER 200	200	5		507145	507282	507187		
T-RACE								
T-RACE C	EL	15			507356			
T-RACE E	EL	15			507356			
T-RACE R	EL	15			507356			
T-RACE DIABOLICA	EL	15			507358			
TGB								
X - MOTION 125	125	8		507145	507282	507187		
X - MOTION 250i	250	8		507145	507282	507187		
101	125	5						507383
101	150	5						507383
303 R	125	99						
409 F	125	2	5					
409 F	150	2	5					
409 F	125	6						507383
409 F	150	6						507383
42 RACING 125	125	6						507383
42 RACING 150	150	6						507383
PLATFORM 125	125	6						
PLATFORM 150	150	6						
SUNSET 150	150	7						
TGB 4 WHEELS								
QUADBLADE 250	250	6		507081	507216			
QUADBLADE 325	325	7		507085	507222	507152		
QUADBLADE 400	400	6		507088	507225			
AVENGER 400	400	7			507363			
TM								
125 GS, MC	125	86	89	507074	507202			
SMM 125	125	14		507074	507202			
125 GS, MC	125	90	92	507081	507216			
400 4T E/CROSS	400	3			507300			

				
Plaquettes arrière			Mâchoires arrière	
SEMI MÉTALLIQUES G1050	SEMI MÉTALLIQUES G1054	SINTERED G1380	N° Schéma	G2165
		507190	40	
		507190	40	
507079	507214		38	
507087	507224		68	
	507234	507180	90	
	507234	507180	90	
	507363		179	
507086	507223		9	
	507363		179	
	507363		179	
	507363		179	
507143	507230	507154	48	
507143	507230	507154	48	
507143	507230	507154	48	
507143	507230	507154	48	
507108	507247	507159	34	
507108	507247	507159	34	
507085	507222	507152	25	
507085	507222	507152	25	
507085	507222	507152	25	
507124	507260		24	
507124	507260		24	
507124	507260		24	
507124	507260		24	
507108	507247	507159	34	
507108	507247	507159	34	
507085	507222	507152	25	
507081	507216		23	
507081	507216		23	
507081	507216		23	
	507363		179	
	507298		123	
	507347		161	
	507298		123	
507143	507230	507154	48	

PLAQUETTES DE FREIN - MÂCHOIRES DE FREIN / BRAKE PADS - BRAKE SHOE

MOTEUR

CYCLE

PNEUMATIQUE

ATELIER

ACCESSOIRES

ÉLECTRICITÉ

FILTRATION

FREINAGE

TRANSMISSION

Modèle	Cylindre	Depuis	Jusqu'à	GALFER MOTO			GALFER MOTO	
				Plaquettes avant			Mâchoires avant	
				SEMI MÉTALLIQUES G1050	SEMI MÉTALLIQUES G1054	SINTERED G1380	N° Schéma	G2165
530 4T E/CROSS	530	3			507300			
125 CROSS	125	0			507320			
125 ENDURO/MX	125	0			507320			
125 GS, MC	125	93			507320			
250 ENDURO 4T	250	0			507320			
300 ENDURO 4T	300	1			507320			
400 4T E/CROSS	400	0	2		507320			
EN 125	125	4	14		507356			
EN 125	125	15			507356			
EN 250	250	4	14		507356			
EN 250	250	15			507356			
EN 250 F	250	4	14		507356			
EN 250 F	250	15			507356			
EN 300	300	14	14		507356			
EN 300	300	15			507356			
EN 450 F	450	4	14		507356			
EN 450 F	450	15			507356			
EN 530 F	530	4	14		507356			
EN 530 F	530	15			507356			
ENI44	144	14	14		507356			
ENI44	144	15			507356			
MX 125	125	5	14		507356			
MX 125	125	15			507356			
MX 144	144	15			507356			
MX 250	250	5	14		507356			
MX 250	250	15			507356			
MX 250 F	250	5	14		507356			
MX 250 F	250	15			507356			
MX 300	300	14	14		507356			
MX 300	300	15			507356			
MX 450 F	450	5	14		507356			
MX 450 F	450	15			507356			
MX 530 F	530	5	14		507356			
MX 530 F	530	15			507356			
SMM 530 F	530	14			507356			
SMR 125	125	14			507356			
SMR 450 F	450	14	14		507356			
SMR 450 F	450	15			507356			
SMR 530 F	530	14	14		507356			
SMR 530 F	530	15			507356			
SMX 450 F	450	4	14		507356			
SMX 530 F	530	10	14		507356			

GALFER MOTO			GALFER MOTO	
Plaquettes arrière			Mâchoires arrière	
SEMI MÉTALLIQUES G1050	SEMI MÉTALLIQUES G1054	SINTERED G1380	N° Schéma	G2165
507143	507230	507154	48	
507143	507230	507154	48	
507143	507230	507154	48	
507143	507230	507154	48	
507143	507230	507154	48	
507143	507230	507154	48	
507143	507230	507154	48	
507143	507230	507154	48	
507143	507230	507154	48	
507143	507230	507154	48	
507143	507230	507154	48	
507143	507230	507154	48	
507143	507230	507154	48	
507143	507230	507154	48	
507143	507230	507154	48	
507143	507230	507154	48	
507143	507230	507154	48	
507143	507230	507154	48	
507143	507230	507154	48	
507143	507230	507154	48	
507143	507230	507154	48	
507143	507230	507154	48	
507143	507230	507154	48	
507143	507230	507154	48	
507143	507230	507154	48	
507143	507230	507154	48	
507143	507230	507154	48	
507143	507230	507154	48	
507143	507230	507154	48	
507143	507230	507154	48	
507143	507230	507154	48	
507143	507230	507154	48	
507143	507230	507154	48	
507143	507230	507154	48	
	507347		161	
	507347		161	
	507347		161	
	507347		161	
	507347		161	
	507347		161	
	507347		161	

MOTEUR

CYCLE

PNEUMATIQUE

ATELIER

ACCESSOIRES

ÉLECTRICITÉ

FILTRATION

FREINAGE

TRANSMISSION

PLAQUETTES DE FREIN - MÂCHOIRES DE FREIN / BRAKE PADS - BRAKE SHOE

Modèle	Cylindre	Depuis	Jusqu'à	GALFER MOTO			GALFER MOTO	
				Plaquettes avant			Mâchoires avant	
				SEMI MÉTALLIQUES G1050	SEMI MÉTALLIQUES G1054	SINTERED G1380	N° Schéma	G2165
SMX 660 F	660	4	14		507356			
SMX 660 F	660	15			507356			
TOMOS								
125 SE	125	4		507077	507212	507151		
125 SM	125	5		507077	507212	507151		
TORROT								
BUSINESS	EL	18		507086	507223			
CITY	EL	18		507086	507223			
MUVI	EL	18		507086	507223			
TRIAL TXE	EL	18		507118	507254			
TRIUMPH								
AMERICA	800	5			507221			
BONNEVILLE /T100	800	4	5		507221			
BONNEVILLE /T100	800	5	7		507221			
BONNEVILLE EFI /T100	800	8			507221			
BONNEVILLE SE	850	9			507221			
DAYTONA 900 T-595	900	97			507221			
DAYTONA 955i	955	99	0		507221			
SCRAMBLER	900	6	7		507221			
SCRAMBLER	900	19			507221			
SCRAMBLER EFI	900	8	18		507221			
SPEED TRIPLE 1050	1050	5	5		507221			
SPEED TRIPLE 1050	1050	8	10		507221			
SPEED TRIPLE 1050	1050	11	11		507221			
SPEED TRIPLE 1050	1050	6	7		507221			
SPEED TRIPLE 955 i	955	99	1		507221			
SPEED TRIPLE 955 i	955	2			507221			
SPEED TRIPLE R	1050	12	17		507221			
SPEED TRIPLE RS	1050	18			507221			
SPEED TRIPLE S	1050	16	17		507221			
SPEED TRIPLE S	1050	18			507221			
SPEED TWIN 900	900	22			507221			
SPRINT GT 1050	1050	10			507221			
SPRINT ST 1050	1050	5	5		507221			
SPRINT ST 1050	1050	6			507221			
SPRINT ST 955	955	99			507221			
STREET SCRAMBLER	900	17	18		507221			
STREET SCRAMBLER	900	19			507221			
STREET TWIN	900	16	18		507221			
STREET TWIN	900	19			507221			
T-100	900	17			507221			
T-100 BLACK	900	17			507221			

PLAQUETTES DE FREIN - MÂCHOIRES DE FREIN / BRAKE PADS - BRAKE SHOE

MOTEUR

CYCLE

PNEUMATIQUE

ATELIER

ACCESSOIRES



ÉLECTRICITÉ

FILTRATION

FREINAGE

TRANSMISSION

Modèle	Cylindre	Depuis	Jusqu'à	GALFER MOTO			Plaquettes avant		GALFER MOTO	
				SEMI MÉTALLIQUES G1050	SEMI MÉTALLIQUES G1054	SINTERED G1380	N° Schéma	Mâchoires avant G2165		
T-120	1200	16			507221					
T-120 BLACK	1200	16			507221					
BONNEVILLE BOBBER	1200	18			507305					
BONNEVILLE BOBBER	1200	17	17		507305					
BONNEVILLE BOBBER BLACK	1200	18			507305					
BONNEVILLE BOBBER SPORT	1200	20			507305					
BONNEVILLE SPEEDMASTER	1200	18			507305					
DAYTONA 600	600	3			507305					
DAYTONA 650	650	3	5		507305					
DAYTONA 955i	955	1	1		507305					
DAYTONA 955i	955	2			507305					
SPEED FOUR	600	3			507305					
TIGER 660 SPORT	660	22			507305					
TIGER 800	800	11			507305					
TIGER 800 XC	800	11	14		507305					
TIGER 800 XC ABS	800	11	14		507305					
TIGER 800 XCx	800	19	20		507305					
TIGER 800 XCx	800	15	18		507305					
TIGER 800 XCx ABS	800	19	20		507305					
TIGER 800 XCx ABS	800	15	18		507305					
TIGER 800 XRx	800	19	20		507305					
TIGER 800 XRx	800	15	18		507305					
TIGER 800 XRx ABS	800	19	20		507305					
TIGER 800 XRx ABS	800	19	18		507305					
TRIDENT 660	660	21			507305					
TT 600	600	0			507305					
1200-3 (right)	1200	93		507088	507225					
1200-4 (right)	1200	93		507088	507225					
DAYTONA 1100 SPORT	1100	91		507088	507225					
DAYTONA 750 SPORT	750	91		507088	507225					
DAYTONA 900	900	93	96	507088	507225					
SPEED TWIN 1200	1200	20		507088	507225					
SPRINT 900 (right)	900	93		507088	507225					
SPRINT RS	955	0		507088	507225					
STREET CUP	900	17		507088	507225					
THRUXTON	1200	16		507088	507225					
THRUXTON R	1200	16		507088	507225					
THRUXTON R BLACK	1200	20		507088	507225					
THRUXTON RS	1200	20		507088	507225					
TIGER 1050	1050	7		507088	507225					
TIGER 1050 ABS	1050	7		507088	507225					
TIGER 900 (right)	900	93	98	507088	507225					

 Plaquettes arrière			 Mâchoires arrière	
SEMI MÉTALLIQUES G1050	SEMI MÉTALLIQUES G1054	SINTERED G1380	N° Schéma	G2165
507128	507167		44	
507128	507167		44	
507143	507230	507154	48	
507128	507167		44	
507143	507230	507154	48	
507143	507230	507154	48	
507143	507230	507154	48	
	507303		128	
	507303		128	
	507303		128	
	507303		128	
	507303		128	
507128	507167		44	
507128	507167		44	
507128	507167		44	
507128	507167		44	
507143	507230	507154	48	
507128	507167		44	
507143	507230	507154	48	
507128	507167		44	
507143	507230	507154	48	
507128	507167		44	
507143	507230	507154	48	
507128	507167		44	
507128	507167		44	
	507303		128	
507088	507225		31	
507088	507225		31	
	507303		128	
	507303		128	
	507303		128	
507088	507225		31	
	507303		128	
507128	507167		44	
507128	507167		44	
	507362		178	
	507362		178	
507088	507225		31	

PLAQUETTES DE FREIN - MÂCHOIRES DE FREIN / BRAKE PADS - BRAKE SHOE

Modèle	Cylindre	Depuis	Jusqu'à	GALFER MOTO			GALFER MOTO	
				Plaquettes avant			Mâchoires avant	
				SEMI MÉTALLIQUES G1050	SEMI MÉTALLIQUES G1054	SINTERED G1380	N° Schéma	G2165
TIGER 955	955	99		507088	507225			
TIGER SPORT 1050 ABS	1050	13		507088	507225			
TRIDENT 750 (right)	750	93		507088	507225			
TRIDENT 900 (right)	900	93		507088	507225			
TRIDENT 900 SPRINT	900	95		507088	507225			
TROPHY 1200	1200	94		507088	507225			
TROPHY 1200 (right)	1200	91	93	507088	507225			
TROPHY 900	900	94		507088	507225			
TROPHY 900 (right)	900	92	93	507088	507225			
ADVENTURER	900	99		507094	507231			
BONNEVILLE AMERICA	750	2		507094	507231			
LEGEND TT	900	99		507094	507231			
SPEEDMASTER	790	3		507094	507231			
THUNDERBIRD 900/SPORT	900	95		507094	507231			
BOBBER TFC	1200	20			507320			
TIGER 1200 GT	1200	22			507320			
TIGER 1200 GT EXPLORER	1200	22			507320			
TIGER 1200 GT PRO	1200	22			507320			
TIGER 1200 RALLY EXPLORER	1200	22			507320			
TIGER 1200 RALLY PRO	1200	22			507320			
TIGER 900	900	20			507320			
TIGER 900 GT / PRO	900	20			507320			
TIGER 900 RALLY / PRO	900	20			507320			
SCRAMBLER 1200 XC	1200	19			507322			
SCRAMBLER 1200 XE	1200	19			507322			
THUNDERBIRD 1600	1600	9			507322			
THUNDERBIRD COMMANDER	1700	14			507322			
THUNDERBIRD STORM 1700	1700	11			507322			
TIGER 1200 XC	1200	18	21	507107	507246	507158		
TIGER 1200 XCA	1200	18	21	507107	507246	507158		
TIGER 1200 XCX	1200	18	21	507107	507246	507158		
TIGER 1200 XR	1200	18	21	507107	507246	507158		
TIGER 1200 XRT	1200	18	21	507107	507246	507158		
TIGER 1200 XRX	1200	18	21	507107	507246	507158		
TIGER EXPLORER	1200	12	15	507107	507246	507158		
TIGER EXPLORER XC	1200	16	17	507107	507246	507158		
TIGER EXPLORER XCA	1200	16	17	507107	507246	507158		
TIGER EXPLORER XCX	1200	16	17	507107	507246	507158		
TIGER EXPLORER XR	1200	16	17	507107	507246	507158		
TIGER EXPLORER XRT	1200	16	17	507107	507246	507158		
TIGER EXPLORER XRX	1200	16	17	507107	507246	507158		
SPEED TRIPLE 1200 RR	1200	22		507116	507252	507164		

PLAQUETTES DE FREIN - MÂCHOIRES DE FREIN / BRAKE PADS - BRAKE SHOE

MOTEUR

CYCLE

PNEUMATIQUE

ATELIER

ACCESSOIRES



ÉLECTRICITÉ

FILTRATION

FREINAGE

TRANSMISSION

Modèle	Cylindre	Depuis	Jusqu'à	GALFER MOTO Plaquettes avant			N° Schéma	Mâchoires avant G2165
				SEMI MÉTALLIQUES G1050	SEMI MÉTALLIQUES G1054	SINTERED G1380		
SPEED TRIPLE 1200 RS	1200	21		507116	507252	507164		
1200-3 (left)	1200	93						
1200-4 (left)	1200	93						
SPRINT 900 (left)	900	93						
TIGER 900 (left)	900	93	98					
TRIDENT 750 (left)	750	93						
TRIDENT 900 (left)	900	93						
TROPHY 1200 (left)	1200	91	93					
TROPHY 900 (left)	900	92	93					
TRS								
ONE 280	300	16		507118	507254			
ONE 300	300	16		507118	507254			
TVS COLOMBIA								
APACHE 200	200	17						
APACHE RTR 160	160	12						
APACHE RTR 180	180	12						
ROCKZ 125	125	16						
STRYKER 125	125	16						
UM COLOMBIA								
FASTWIND 180	180			507079	507214			
FASTWIND 220	220			507079	507214			
V2S 250 R	250			507079	507214			
FASTWIND 200 R	200			507088	507225			
XTREET 200 NAKED SPORT	200			507088	507225			
DSF 200	200							
DSR 200	200							
DTF 200	200							
DYNAMIC 125	125							
FASTWIND 150 R	150							
GPI 150 R	150							
MAGNETIC 125	125							
MAX 125 R	125							
NITROX 125 R	125							
POWER MAX GP 125	125							
REV 180 R	180							
SMF 200	200							
XPEED 150	150							
V2S 650 R	650							
URAL								
URAL CROSS	750	11						
URAL RANGER	750	11						
URAL RETRO	750	11						



				
Plaquettes arrière			Mâchoires arrière	
SEMI MÉTALLIQUES G1050	SEMI MÉTALLIQUES G1054	SINTERED G1380	N° Schéma	G2165
	507221		33	
	507221		33	
	507221		33	
	507221		33	
	507221		33	
	507221		33	
	507221		33	
	507221		33	
	507221		33	
	507343		157	
	507343		157	
507088	507225		31	
507088	507225		31	
507088	507225		31	
507088	507225		31	
507088	507225		31	
507079	507214		38	
507079	507214		38	
507079	507214		38	
507079	507214		38	
507079	507214		38	
	507221		33	
	507221		33	
	507221		33	
507079	507214		38	
507079	507214		38	
	507221		33	
507124	507260		24	
507124	507260		24	
507086	507223		9	
	507221		33	
507124	507260		24	
	507221		33	
	507221		33	
507079	507214		38	
	507324		149	
	507324		149	
	507324		149	

PLAQUETTES DE FREIN - MÂCHOIRES DE FREIN / BRAKE PADS - BRAKE SHOE

Modèle	Cylindre	Depuis	Jusqu'à	GALFER MOTO Plaquettes avant			N° Schéma	Mâchoires avant G2165
				SEMI MÉTALLIQUES G1050	SEMI MÉTALLIQUES G1054	SINTERED G1380		
URAL SOLO	750	11						
URAL SPORTSMAN	750	11						
URAL TOURIST	750	11						
URAL URAL T	750	11						
URAL WOLF	750	11						
UVM								
BINGO 125	125	99						
VECTRIX								
VECTRIX VT 1	EL	14		507081	507216			
VECTRIX VX 2	EL	12		507085	507222	507152		
VECTRIX VX 1	EL	7		507143	507230	507154		
VECTRIX VX 3	EL	12		507143	507230	507154		
VENTO								
PHANTERA 150	150	6						
PHANTOM r4i	150	6						
WORKMAN	125	6						
VERTEMATI								
492 ENDURO	500	99	0		507320			
492 SUPERMOTARD	500	99	0		507320			
495 CROSS	500	99	0		507320			
C500	500	1	1		507320			
E 510	500	2			507320			
VERTIGO								
COMBAT CAMO	300	15		507118	507254			
COMBAT ICE HELL	300	15		507118	507254			
VICTORY								
CROSS ROADS	1500	10		507094	507231			
JACKPOT	1500	10		507094	507231			
KING PIN	1500	8		507094	507231			
EMPULSE TT	EL	16			507320			
OCTANE	1200	17			507320			
CRUISER	1500	1			507322			
DE LUXE	1500	1			507322			
HAMMER / S	1500	1	7		507322			
SPORTCRUISER	1500	1			507322			
TOURING CRUISER	1500	3			507322			
V92C	1500	1			507322			
VEGAS	1500	3	7		507322			
VEGAS 8 BALL	1500	5	7		507322			
VOGE								
SFIDA SR4 350	350	22						
AC 300	300	22			507305			

PLAQUETTES DE FREIN - MÂCHOIRES DE FREIN / BRAKE PADS - BRAKE SHOE

Modèle	Cylindre	Depuis	Jusqu'à	GALFER MOTO			N° Schéma	Mâchoires avant
				SEMI MÉTALLIQUES G1050	SEMI MÉTALLIQUES G1054	SINTERED G1380		
BRIVIDO 500 R	500	22			507305			
DS 300	300	22			507305			
DS 500	500	22			507305			
DS 650	650	22			507305			
R 300	300	22			507305			
R 500	500	22			507305			
RR 300	300	22			507305			
TROFE 500 DSX	500	22			507305			
TROFEO 500 AC	500	22			507305			
TROFEO 525 ACX	525	22			507305			
TROFEO 525 DSX	525	22			507305			
TROFEO 650 DSX	650	22			507305			
VALICO 500 DSX	500	22			507305			
SFIDA SR125	125	23			507320			
TROFEO 350 AC	350	22			507320			
VALICO 900 DS	900	22			507320			
E-SCOOTER REAL ST	EL	23		507116	507252	507164		
VALICO 300 RALLY	300	22						
BRIVIDO 125 R	125	23						
TROFEO 300 ACX SCRAMBLER RIGTH	300	22						
TROFEO 300 ACX SCRAMBLER LEFT	300	22						
VOLTA								
FOREST	EL	18		507081	507216			
SM	EL	18		507081	507216			
BCN	EL	18		507116	507252	507164		
SPORT	EL	18		507116	507252	507164		
VOR								
EN 400	400	0			507320			
EN 450	450	1			507320			
EN 530	530	1			507320			
MX 350	350	1			507320			
VOXAN								
SCRAMBLER	1000	0			507320			
BOXER	1000	0		507116	507252	507164		
CAFÉ RACER	1000	99		507116	507252	507164		
CHARADE RACING	1000	6		507116	507252	507164		
GTV 1200	1200	8		507116	507252	507164		
ROADSTER	1000	99		507116	507252	507164		
YAMAHA								
TZR 125, MARLBORO RED ROCKET	125	93		507074	507202			
BT 1100 BULL DOG	1100	1			507292			
FJ 1100	1100	84	86		507292			

				
Plaquettes arrière			Mâchoires arrière	
SEMI MÉTALLIQUES G1050	SEMI MÉTALLIQUES G1054	SINTERED G1380	N° Schéma	G2165
507128	507167		44	
507108	507247	507159	34	
507128	507167		44	
507128	507167		44	
	507368		184	
507128	507167		44	
	507368		184	
507128	507167		44	
507128	507167		44	
507128	507167		44	
507128	507167		44	
507128	507167		44	
507128	507167		44	
507107	507246	507158	102	
	507322		147	
	507322		147	
	507234	507180	90	
507107	507246	507158	102	
	507234	507180	90	
	507234	507180	90	
507107	507246	507158	102	
	507221		33	
	507221		33	
		507181	37	
		507181	37	
507143	507230	507154	48	
507143	507230	507154	48	
507143	507230	507154	48	
507143	507230	507154	48	
	507324		149	
	507324		149	
	507324		149	
	507347		161	
	507347		161	
	507324		149	
507078	507213		87	
	507245	507179	20	
	507297		122	

PLAQUETTES DE FREIN - MÂCHOIRES DE FREIN / BRAKE PADS - BRAKE SHOE

MOTEUR

CYCLE

PNEUMATIQUE

ATELIER

ACCESSOIRES



ÉLECTRICITÉ

FILTRATION

FREINAGE

TRANSMISSION

Modèle	Cylindre	Depuis	Jusqu'à	GALFER MOTO			GALFER MOTO	
				Plaquettes avant			Mâchoires avant	
				SEMI MÉTALLIQUES G1050	SEMI MÉTALLIQUES G1054	SINTERED G1380	N° Schéma	G2165
FJ 1200	1200	85	87		507292			
FJ 1200	1200	88			507292			
FJ 600	600	84			507292			
FZ 1000 R	1000	87	89		507292			
FZ 400 FAZER	400	1			507292			
FZ 600	600	87	87		507292			
FZ 700	700	87			507292			
FZ 750	750	85	86		507292			
FZ 750 GENESIS, A	750	87			507292			
FZ 750 R COMPETITION	750	89	92		507292			
FZR 1000 EXUP	1000	89	92		507292			
FZR 1000 EXUP	1000	93	95		507292			
FZR 600	600	89	89		507292			
FZR 600	600	90	95		507292			
FZR 600 GENESIS	600	91	95		507292			
FZR 750 R(OWOI)	750	89	92		507292			
FZX 700 FAZER	700	87			507292			
FZX 750	750	86			507292			
GTS 1000 OMEGA	1000	93			507292			
RD 250 LC	250	83			507292			
RD 350 LC	350	81	84		507292			
RD 500	500	83	83		507292			
RZ 350 L	350	84			507292			
TDM 850	850	90	1		507292			
TRX 850	850	95			507292			
V MAX 1200 VMX	1200	85	92		507292			
V MAX 1200 VMX	1200	93	94		507292			
V MAX 1200 VMX	1200	95	2		507292			
V MAX 1200 XMS	1200	3			507292			
VENTURE ROYALE 1300	1300	90			507292			
VXZ 1200 L, K2C	1200	84			507292			
XJ 600	600	84	91		507292			
XJ 750	750	83			507292			
XJ 900 F	900	83	90		507292			
XJ 900 S DIVERSION	900	95			507292			
XJR 1200	1200	94	94		507292			
XJR 1200 (EUROPA)	1200	95			507292			
XJR 1300	1300	99	0		507292			
XJR 400 R	400	93	96		507292			
XJR 400 R	400	97	0		507292			
XS 400 Z	400	83			507292			
XS-VI SAKURA	1000	9			507292			

 Plaquettes arrière			 Mâchoires arrière	
SEMI MÉTALLIQUES G1050	SEMI MÉTALLIQUES G1054	SINTERED G1380	N° Schéma	G2165
	507292		116	
	507297		122	
	507292		116	
	507297		122	
	507324		149	
	507292		116	
	507292		116	
	507292		116	
	507292		116	
	507297		122	
	507313		134	
	507292		116	
	507297		122	
	507313		134	
	507303		128	
	507292		116	
	507292		116	
	507292		116	
	507297		122	
	507324		149	
	507292		116	
	507313		134	
	507313		134	
	507313		134	
	507297		122	
	507292		116	
	507292		116	
	507292		116	
	507292		116	
507095	507232	507155	62	
	507313		134	
507078	507213		87	
	507245	507179	20	
507104	507242	507157	63	
	507324		149	
	507292		116	
507104	507242	507157	63	

PLAQUETTES DE FREIN - MÂCHOIRES DE FREIN / BRAKE PADS - BRAKE SHOE

CGN
LE SENS DU DÉTAIL

MOTEUR

CYCLE

PNEUMATIQUE

ATELIER

ACCESSOIRES



ÉLECTRICITÉ

FILTRATION

FREINAGE

TRANSMISSION

Modèle	Cylindre	Depuis	Jusqu'à	GALFER MOTO			Plaquettes avant		GALFER MOTO	
				SEMI MÉTALLIQUES G1050	SEMI MÉTALLIQUES G1054	SINTERED G1380	N° Schéma	Mâchoires avant G2165		
XV 1200 DL, DC2	1200	84			507292					
XVS 1100 DRAG STAR	1100	99			507292					
XVZ 1200 T, VENTURE ROYALE	1200	84	87		507292					
YZF 1.000 THUNDER ACE	1000	96	98		507292					
YZF 600 THUNDER CAT	600	96	0		507292					
YZF 750 R, SP	750	93	95		507292					
TY 250 , Z, M	250	93		507077	507212	507151				
FZ 400 R	400	86	87		507293					
FZ 600	600	88	88		507293					
FZ 600 S	600	86	86		507293					
FZR 250 R	250	89			507293					
FZR 400 R	400	88	89		507293					
FZR 400 RR	400	90			507293					
FZS 600 FAZER	600	98	99		507293					
FZS 600 S FAZER	600	0	3		507293					
RI-Z	250	90			507293					
RD 350 LC, F	350	85	90		507293					
RD 350 R	350	91			507293					
RD 500 LC	500	84	86		507293					
RD 500 LC (YPVS)	500	87			507293					
SDR 200	200	87			507293					
SRX 400	400	87			507293					
SRX 600	600	85	86		507293					
SRX 600	600	87	89		507293					
SRX Classic by BIRD	600	90			507293					
TDR 125 R	125	91	92		507293					
TDR 250	250	87	92		507293					
TZR 125	125	90	91		507293					
TZR 125	125	92			507293					
XJ 600 N / S	600	95	97		507293					
XJ 600 N / S	600	96	3		507293					
XJ 600 S DIVERSION	600	91	97		507293					
XJ 600 S DIVERSION	600	98	8		507293					
XJ 600 SECA II	600	92	93		507293					
TDR 125	125	89	90	507081	507216					
YZ 360	360	89	89		507295					
DT 125	125	99		507082	507218					
DT 125 R/RE	125	88	4	507082	507218					
DT 200 R	200	88		507082	507218					
TDR 125 R	125	93		507082	507218					
TT 600 S	600	94		507082	507218					
XT 600	600	87	88	507082	507218					

				
Plaquettes arrière			Mâchoires arrière	
SEMI MÉTALLIQUES G1050	SEMI MÉTALLIQUES G1054	SINTERED G1380	N° Schéma	G2165
	507292		116	
507104	507242	507157	63	
	507292		116	
	507245	507179	20	
	507245	507179	20	
507077	507212	507151	6	
	507292		116	
	507292		116	
	507292		116	
	507245	507179	20	
	507297		122	
	507245	507179	20	
	507245	507179	20	
	507245	507179	20	
507078	507213		87	
	507293		117	
	507293		117	
	507292		116	
	507292		116	
	507293		117	
	507297		122	
	507293		117	
	507297		122	
	507293		117	
507078	507213		87	
	507297		122	
	507292		116	
	507303		128	
507095	507232	507155	62	
507104	507242	507157	63	
507095	507232	507155	62	
507104	507242	507157	63	
507095	507232	507155	62	
	507298		123	
	507221		33	
507082	507218		70	
507082	507218		70	
507082	507218		70	
507104	507242	507157	63	
507082	507218		70	

PLAQUETTES DE FREIN - MÂCHOIRES DE FREIN / BRAKE PADS - BRAKE SHOE

MOTEUR

CYCLE

PNEUMATIQUE

ATELIER

ACCESSOIRES



ÉLECTRICITÉ

FILTRATION

FREINAGE

TRANSMISSION

Modèle	Cylindre	Depuis	Jusqu'à	GALFER MOTO			GALFER MOTO	
				Plaquettes avant			Mâchoires avant	
				SEMI MÉTALLIQUES G1050	SEMI MÉTALLIQUES G1054	SINTERED G1380	N° Schéma	G2165
XT 600 E	600	90	94	507082	507218			
XT 600 E	600	95		507082	507218			
XT 600 Z TENERE	600	89		507082	507218			
XT TENERE	600	87	90	507082	507218			
XTZ 660 TENERE	660	93	98	507082	507218			
YZ 125	125	88	88	507082	507218			
XV 1600 WILD STAR	1600	99			507297			
XVZ 1300 TD	1300	88			507297			
XZV 1.300 ROYAL STAR	1300	96	98		507297			
XZV 1.300 TF ROYAL STAR VENTURE	1300	99			507297			
WR 400 F	400	98	98		507300			
WR 400 F	400	99	99		507300			
YZ 125, WR	125	98	0		507300			
YZ 125, WR	125	1	2		507300			
YZ 250 F, WR F 4T	250	0	0		507300			
YZ 250 F, WR F 4T	250	1	2		507300			
YZ 250, WR	250	99	0		507300			
YZ 250, WR	250	1	2		507300			
YZ 400 F	400	98	98		507300			
YZ 400 F	400	99	99		507300			
XJ 6 S DIVERSION (FZ 6 R USA)	600	9			507305			
XJ 6 S DIVERSION ABS	600	9			507305			
XJ 6 S DIVERSION F	600	10			507305			
XJ 6 S DIVERSION NAKED	600	9			507305			
TZ 250	250	88	88	507087	507224			
TZ 250 W	250	89	89	507087	507224			
DT 125 R	125	5			507310			
DT 125 X	125	5			507310			
FZS 25	250	19			507310			
MT 125	125	20			507310			
R 125	125	22			507310			
SEROW 250	250	4			507310			
TT 250 R	250	93			507310			
TT 600	600	93	94		507310			
WR 125	125	91			507310			
WR 200 R	200	93			507310			
WR 250	250	91			507310			
WR 500	500	92			507310			
XG 250 TRICKER	250	4			507310			
XSR 125	125	21			507310			
XSR 125 LEGACY	125	23			507310			
XT 250 X	250	6			507310			

 Plaquettes arrière			 Mâchoires arrière	
SEMI MÉTALLIQUES G1050	SEMI MÉTALLIQUES G1054	SINTERED G1380	N° Schéma	G2165
	507314		139	
	507314		139	
	507314		139	
	507314		139	
507095	507232	507155	62	
	507297		122	
	507297		122	
507095	507232	507155	62	
	507319		144	
	507319		144	
	507319		144	
	507319		144	
	507319		144	
	507319		144	
	507319		144	
	507319		144	
	507319		144	
507104	507242	507157	63	
507104	507242	507157	63	
507104	507242	507157	63	
507104	507242	507157	63	
	507297		122	
	507303		128	
507082	507218		70	
	507322		147	
507093	507280	507175	29	
	507368		184	
	507368		184	
507115	507251	507163	66	
	507221		33	
	507221		33	
	507221		33	
	507221		33	
	507221		33	
	507221		33	
507115	507251	507163	66	
507144	507281		74	
507144	507281		74	
507115	507251	507163	66	

PLAQUETTES DE FREIN - MÂCHOIRES DE FREIN / BRAKE PADS - BRAKE SHOE

Modèle	Cylindre	Depuis	Jusqu'à	GALFER MOTO			GALFER MOTO	
				Plaquettes avant			Mâchoires avant	
				SEMI MÉTALLIQUES G1050	SEMI MÉTALLIQUES G1054	SINTERED G1380	N° Schéma	G2165
XTZ 250 X	250	7			507310			
YS 250 FAZER	250	11			507310			
YZ 125, WR	125	90	91		507310			
YZ 125, WR	125	92	97		507310			
YZ 250, W, RALLY	250	90	91		507310			
YZ 250, WR	250	89	89		507310			
YZ 250, WR	250	92	98		507310			
YZ 360, RALLY	360	90			507310			
YZF 125 R	125	18			507310			
XTZ 750 SUPER TENERE (right)	750	89		507088	507225			
FAZER 8	800	10			507315			
FZ 1/ FAZER	1000	6			507315			
FZ 6 /S FAZER ABS	600	6	6		507315			
FZ 6 FAZER	600	4	6		507315			
FZ 6 FAZER S2	600	7			507315			
FZ 6 FAZER S2 ABS	600	7			507315			
FZ 6 S FAZER	600	4	6		507315			
FZ 6 S2	600	7			507315			
FZ 6 S2 ABS	600	7			507315			
FZ 8	800	10			507315			
MT 07	700	14	20		507315			
MT 07 ABS	700	14	20		507315			
MT 07 ABS	700	21			507315			
MT 07 MOTOCAGE	700	15			507315			
MT 07 MOTOCAGE ABS	700	15			507315			
MT 09	850	13			507315			
MT 09 ABS	850	13			507315			
MT 09 SP	850	18			507315			
MT 09 SPORTS TRACKER ABS	850	14			507315			
MT 09 STREET RALLY	850	14			507315			
MT 10	1000	16			507315			
MT 10 SP	1000	17			507315			
MT 10 TOURER EDITION	1000	18			507315			
NIKEN	850	18			507315			
NIKEN GT	850	19			507315			
R-7	700	22			507315			
TRACER	700	16			507315			
TRACER ABS	850	15			507315			
TRACER ABS GT	850	18			507315			
TRACER GT	700	19			507315			
TRACER GT+	850	23			507315			
XSR 700	700	15			507315			

PLAQUETTES DE FREIN - MÂCHOIRES DE FREIN / BRAKE PADS - BRAKE SHOE

MOTEUR

CYCLE

PNEUMATIQUE

ATELIER

ACCESSOIRES



ÉLECTRICITÉ

FILTRATION

FREINAGE

TRANSMISSION

Modèle	Cylindre	Depuis	Jusqu'à	GALFER MOTO			Plaquettes avant		GALFER MOTO	
				SEMI MÉTALLIQUES G1050	SEMI MÉTALLIQUES G1054	SINTERED G1380	N° Schéma	Mâchoires avant G2165		
XSR 900	900	16			507315					
XSR 900 LEGEND BLUE	900	23			507315					
YZF 1.000 R-1	1000	4	5		507315					
YZF 1.000 R-1	1000	6	6		507315					
YZF 1.000 R-1	1000	7	8		507315					
YZF 1.000 R-1	1000	9	11		507315					
YZF 1.000 R-1SP	1000	6	6		507315					
YZF 1.000 R-1 TCS	1000	12	14		507315					
YZF 600 R-46	600	5			507315					
YZF 600 R-6	600	3	4		507315					
YZF 600 R-6	600	5	5		507315					
YZF 600 R-6	600	6	7		507315					
YZF 600 R-6	600	8	16		507315					
VERSITY	300	3		507143	507230	507154				
TZ 125 GP	125	94								
TZ 250	250	90								
MAJESTY S	125	15			507320					
MT-03	660	6			507320					
SZR 660	660	95			507320					
TT 600	600	95	97		507320					
TT 600 R	600	99	2		507320					
TT 600 RE	600	3			507320					
WR 125 R	125	9			507320					
WR 125 X	125	9			507320					
XT 660 R	660	4			507320					
XT 660 X	660	4			507320					
XT 660 Z TENERE	660	8			507320					
XTZ 700 TENERE	700	19			507320					
YW 125 S ZUMA	125	18			507320					
SP 250 DX MAGESTY	250	98	99	507115	507251	507163				
SP 250 DX MAGESTY	250	0		507115	507251	507163				
X - CITY	250	7		507115	507251	507163				
X - MAX 125	125	10	14	507115	507251	507163				
X - MAX 125	125	15	20	507115	507251	507163				
X - MAX 125 ABS	125	10	14	507115	507251	507163				
X - MAX 125 ABS	125	15	20	507115	507251	507163				
X - MAX 250	250	10	13	507115	507251	507163				
X - MAX 250	250	5	9	507115	507251	507163				
X - MAX 250 ABS	250	14		507115	507251	507163				
X - MAX 400	400	13	17	507115	507251	507163				
YZF 1.000 R-1	1000	2	3	507115	507251	507163				
YZF 600 R-6	600	99	2	507115	507251	507163				

				
Plaquettes arrière			Mâchoires arrière	
SEMI MÉTALLIQUES G1050	SEMI MÉTALLIQUES G1054	SINTERED G1380	N° Schéma	G2165
	507245	507179	20	
	507245	507179	20	
	507245	507179	20	
	507245	507179	20	
	507245	507179	20	
	507245	507179	20	
	507245	507179	20	
	507245	507179	20	
	507245	507179	20	
507143	507230	507154	48	
	507303		128	
	507303		128	
507093	507280	507175	29	
507104	507242	507157	63	
507078	507213		87	
507143	507230	507154	48	
507143	507230	507154	48	
507143	507230	507154	48	
507128	507167		44	
507128	507167		44	
	507322		147	
	507324		149	
507143	507230	507154	48	
507143	507230	507154	48	
507128	507167		44	
507104	507242	507157	63	
507104	507242	507157	63	
507094	507231		46	
507128	507167		44	
507128	507167		44	
507128	507167		44	
507128	507167		44	
507128	507167		44	
507093	507280	507175	29	
507128	507167		44	
507128	507167		44	
	507245	507179	20	
	507245	507179	20	

PLAQUETTES DE FREIN - MÂCHOIRES DE FREIN / BRAKE PADS - BRAKE SHOE

MOTEUR

CYCLE

PNEUMATIQUE

ATELIER

ACCESSOIRES



ÉLECTRICITÉ

FILTRATION

FREINAGE



TRANSMISSION

Modèle	Cylindre	Depuis	Jusqu'à	GALFER MOTO			Plaquettes avant		GALFER MOTO	
				SEMI MÉTALLIQUES G1050	SEMI MÉTALLIQUES G1054	SINTERED G1380	N° Schéma	Mâchoires avant G2165		
XJR 400 R	400	1			507334					
YZF 1.000 R-1	1000	98	1		507334					
YZF-R7/OW02	750	99			507334					
MAXTER 125	125	1		507116	507252	507164				
MAXTER 150	150	1		507116	507252	507164				
SP 125 MAGESTY	125	1		507116	507252	507164				
SP 150 MAGESTY	150	1		507116	507252	507164				
SP 180 MAGESTY	180	3		507116	507252	507164				
X - CITY	125	9		507116	507252	507164				
X - MAX 125	125	6	9	507116	507252	507164				
TRICITY DER/RIGHT	125	14		507125	507261					
TRICITY DER/RIGHT	300	20		507125	507261					
TRICITY IZQ/LEFT	125	14		507125	507261					
TRICITY IZQ/LEFT	300	20		507125	507261					
XP 500 T-MAX	500	0	3			507184				
XP 500 T-MAX CUP	500	3				507184				
XP 530 T-MAX	530	12	13			507184				
XP 530 T-MAX ABS	530	12	14			507184				
XP 530 T-MAX ABS	530	15	19			507184				
XP 560 T-MAX	560	20				507184				
XP 560 T-MAX TECH MAX	560	20				507184				
XT 125 R	125	5		507129	507266	507168				
XT 125 X	125	5		507129	507266	507168				
WR 250 F 4T	250	3	6		507356					
WR 250 F 4T	250	7	16		507356					
WR 250 F 4T	250	17			507356					
WR 250 R	250	8			507356					
WR 250 X	250	8			507356					
WR 450 F	450	3	11		507356					
WR 450 F	450	12	15		507356					
WR 450 F	450	16	19		507356					
WR 450 F	450	20			507356					
YZ 125	125	8	17		507356					
YZ 125	125	18	21		507356					
YZ 125	125	22			507356					
YZ 125, WR	125	3	3		507356					
YZ 125, WR	125	4	7		507356					
YZ 250	250	8	17		507356					
YZ 250	250	18	21		507356					
YZ 250	250	22			507356					
YZ 250 F	250	3	6		507356					
YZ 250 F	250	7	8		507356					

 Plaquettes arrière			 Mâchoires arrière	
SEMI MÉTALLIQUES G1050	SEMI MÉTALLIQUES G1054	SINTERED G1380	N° Schéma	G2165
	507245	507179	20	
	507245	507179	20	
	507245	507179	20	
507143	507230	507154	48	
507143	507230	507154	48	
507143	507230	507154	48	
507143	507230	507154	48	
507143	507230	507154	48	
507094	507231		46	
507093	507280	507175	29	
		507196	29	
		507196	29	
		507195	56	
		507195	56	
507095	507232	507155	62	
507078	507213		87	
	507245	507179	20	
	507245	507179	20	
	507245	507179	20	
	507245	507179	20	
	507245	507179	20	
507129	507266	507168	18	
		507181	37	
	507319		144	
	507319		144	
	507319		144	
507128	507167		44	
	507319		144	
	507319		144	
	507367		183	
	507367		183	
	507367		183	
	507319		144	
	507319		144	
	507367		183	
	507367		183	
	507319		144	
	507367		183	

PLAQUETTES DE FREIN - MÂCHOIRES DE FREIN / BRAKE PADS - BRAKE SHOE

Modèle	Cylindre	Depuis	Jusqu'à	GALFER MOTO			GALFER MOTO	
				Plaquettes avant			Mâchoires avant	
				SEMI MÉTALLIQUES G1050	SEMI MÉTALLIQUES G1054	SINTERED G1380	N° Schéma	G2165
YZ 250 F	250	9	15		507356			
YZ 250 F	250	16	17		507356			
YZ 250 F	250	18	20		507356			
YZ 250 F	250	21			507356			
YZ 250 F 60th ANNIVERSARY	250	16			507356			
YZ 250 F, WR F 4T	250	3	6		507356			
YZ 450 F	450	3	7		507356			
YZ 450 F	450	8	11		507356			
YZ 450 F	450	12	15		507356			
YZ 450 F	450	16	17		507356			
YZ 450 F	450	18	19		507356			
YZ 450 F	450	20			507356			
YZ 450 F 60th ANNIVERSARY	450	16			507356			
FJR 1300	1300	1	2		507359			
FJR 1300	1300	3	5		507359			
FJR 1300 ABS	1300	6	7		507359			
FJR 1300 ABS	1300	8			507359			
SCR 950	950	17			507359			
TDM 900	900	2	4		507359			
TDM 900 A	900	5			507359			
V MAX 1700	1700	9			507359			
XTZ 1200 SUPER TENERE	1200	10			507359			
XTZ 1200 SUPER TENERE ABS	1200	10			507359			
XTZ 1200 SUPER TENERE ABS RAID EDITION	1200	18			507359			
XTZ 1200 ZE SUPER TENERE ABS	1200	14			507359			
XV 1700 ROAD STAR WARRIOR	1700	2	7		507359			
XV 1700 ROAD STAR WARRIOR	1700	8			507359			
XVS 950	950	13			507359			
XVS 950 A MIDNIGHT STAR	950	9			507359			
XVS 950 BOLT (USA)	950	13			507359			
XVS 950 R	950	13			507359			
XVS MIDNIGHT STAR 1300	1300	7			507359			
XVS STRYKER 1300 (USA)	1300	15			507359			
YZ 125	125	89	89		507360			
YZ 250	250	88	88		507360			
FZ 1 (USA)	1000	98	5		507208			
FZS 1000 FAZER	1000	98	5		507208			
XJR 1300	1300	1			507208			
XJR 1300 RACER	1300	15			507208			
MT 125	125	14	19		507363			
YZF 125 R	125	8	13		507363			

 Plaquettes arrière			 Mâchoires arrière	
SEMI MÉTALLIQUES G1050	SEMI MÉTALLIQUES G1054	SINTERED G1380	N° Schéma	G2165
	507367		183	
	507367		183	
	507367		183	
	507367		183	
	507319		144	
	507319		144	
	507367		183	
	507367		183	
	507367		183	
	507367		183	
	507367		183	
	507367		183	
	507245	507179	20	
	507245	507179	20	
507095	507232	507155	62	
	507245	507179	20	
	507245	507179	20	
	507245	507179	20	
	507245	507179	20	
	507245	507179	20	
	507245	507179	20	
	507245	507179	20	
	507245	507179	20	
	507245	507179	20	
507095	507232	507155	62	
507095	507232	507155	62	
507095	507232	507155	62	
507095	507232	507155	62	
507104	507242	507157	63	
507095	507232	507155	62	
	507221		33	
	507245	507179	20	
	507245	507179	20	
	507245	507179	20	
	507245	507179	20	
	507368		184	
507143	507230	507154	48	

PLAQUETTES DE FREIN - MÂCHOIRES DE FREIN / BRAKE PADS - BRAKE SHOE

CGN
LE SENS DU DÉTAIL

MOTEUR

CYCLE

PNEUMATIQUE

ATELIER

ACCESSOIRES



ÉLECTRICITÉ

FILTRATION

FREINAGE

TRANSMISSION

Modèle	Cylindre	Depuis	Jusqu'à	GALFER MOTO			GALFER MOTO	
				Plaquettes avant			Mâchoires avant	
				SEMI MÉTALLIQUES G1050	SEMI MÉTALLIQUES G1054	SINTERED G1380	N° Schéma	G2165
YZF 125 R	125	14	17		507363			
SP 400 GRAND MAJESTY (JAP)	400	5			507279	507186		
SP 400 MAGESTY	400	4	4		507279	507186		
SP 400 MAGESTY	400	5			507279	507186		
XP 500 T-MAX	500	4	7		507279	507186		
XP 500 T-MAX	500	8			507279	507186		
XP 500 T-MAX ABS	500	4	7		507279	507186		
XP 500 T-MAX ABS	500	8			507279	507186		
XP 500 T-MAX BLACK MAX	500	6	7		507279	507186		
YZF - R1	1000	15			507366			
YZF - R1M	1000	15			507366			
YZF 600 R-6	600	17			507366			
N MAX 125 ABS	125	15		507144	507281			
N MAX 150 ABS	150	15		507144	507281			
X - MAX 400	400	18			507289	507192		
MT 03	320	16						
MT 25	250	16						
X - MAX 125	125	21						
X - MAX 125 TECH MAX	125	21						
X MAX 300	300	17						
X MAX 300 TECH MAX	300	23						
YZF - R25	250	15						
YZF - R3	320	15						
X - MAX 250	250	14		507149	507291	507197		
BELUGA 125 XC	125	93					20	507391
BW'S 125	125	10					15	507386
CRYPTON-X T 135	135	8	14					
CYGNUS 125	125	95	95				13	507384
CYGNUS 125 / R	125	96	2				13	507384
CYGNUS 125 X	125	3	6				15	507386
CYGNUS 125 X i	125	7					15	507386
CYGNUS 150 X	150	7					15	507386
D'ELIGHT	125	14						
DT 125 CHESTERFIELD SCOUT	125	88					10	507381
DT 125 LC	125	87	87				10	507381
DT 125 LC	125	84	86				10	507381
DT 125 LC	125	88					10	507381
DT 125 LC TENERE	125	88					10	507381
DT 125 TENERE	125	89					10	507381
DT 125 TENERE (I)	125	87					10	507381
DTZ 125 TENERE	125	89					10	507381
FLY ONE	150	92					20	507391

				
Plaquettes arrière			Mâchoires arrière	
SEMI MÉTALLIQUES G1050	SEMI MÉTALLIQUES G1054	SINTERED G1380	N° Schéma	G2165
	507368		184	
507104	507242	507157	63	
507095	507232	507155	62	
507104	507242	507157	63	
507104	507242	507157	63	
	507245	507179	20	
507104	507242	507157	63	
	507245	507179	20	
507104	507242	507157	63	
	507245	507179	20	
	507245	507179	20	
	507245	507179	20	
507148	507290	507178	58	
507148	507290	507178	58	
507128	507167		44	
		509024	189	
		509024	189	
		509024	189	
		509024	189	
		509024	189	
		509024	189	
		509024	189	
507128	507167		44	
	507288	507191	92	
507144	507281		74	
			20	507391
507082	507218		70	
507138	507275		110	
507138	507275		110	
507138	507275		110	
507148	507290	507178	58	
	507298		123	
507080	507215		88	
507082	507218		70	
	507298		123	
507080	507215		88	
507080	507215		88	
507082	507218		70	

PLAQUETTES DE FREIN - MÂCHOIRES DE FREIN / BRAKE PADS - BRAKE SHOE

CGN
LE SENS DU DÉTAIL

MOTEUR

CYCLE

PNEUMATIQUE

ATELIER

ACCESSOIRES

ÉLECTRICITÉ

FILTRATION

FREINAGE

TRANSMISSION

Modèle	Cylindre	Depuis	Jusqu'à	GALFER MOTO			GALFER MOTO	
				Plaquettes avant			Mâchoires avant	
				SEMI MÉTALLIQUES G1050	SEMI MÉTALLIQUES G1054	SINTERED G1380	N° Schéma	G2165
RD 125 LC	125	82	84				10	507381
RD 125 LC	125	85					10	507381
SP 125 MAGESTY	125	98	0				20	507391
SP 125 MAGESTY (TAIWAN)	125	99						
SP 250 MAGESTY	250	96	97					
SR 125	125	98					13	507384
SR 125	125	82	97				13	507384
SR 250	250	80	90				10	507381
SR 250, SP	250	91					10	507381
SR 400	400	14						
SR 400	400	2	13					
SRX 250	250	87						
SX 125 R	125	88					13	507384
SX 200 R	200	88						
TEO 'S 125	125	0					20	507391
TEO 'S 150	150	1					20	507391
TT 250	250	86	92				10	507381
TT 350	350	87	91				10	507381
TT 600	600	89	89				10	507381
TT 600	600	87	88				10	507381
TT 600	600	90	92				10	507381
TT R 125	125	0						
TW 125	125	98						
TW 200	200	98					20	507391
TZR 125	125	87	89				10	507381
VINO 125	125	3					13	507384
VITY 125	125	8						
X - ENTER	125	12						
X - ENTER	150	12						
XJ 650	650	80	80				14	507385
XJ 650 (4H7)	650	89					14	507385
XJ 650 G, H, SH, (left)	650	80	80				14	507385
XJ 650 G, H, SH, (right)	650	80	80				14	507385
XJ 650 J, K, L, LK, T, SECA, TURBO	650	83	88				14	507385
XJ 650 RJ	650	82	82				14	507385
XJ 650 SECA, TURBO	650	81	81				14	507385
XJ 750 A, RH, RJ, SECA	750	81	81				14	507385
XT 350 4 VALVES	350	85	90				10	507381
XV 1000	1000	81	83				14	507385
XV 1000 L, C, VIRAGO	1000	84						
XV 1000 SE, MIDNIGHT SPECIAL	1000	84					14	507385
XV 1000 TRI	1000	81					14	507385

GALFER MOTO			GALFER MOTO	
Plaquettes arrière			Mâchoires arrière	
SEMI MÉTALLIQUES G1050	SEMI MÉTALLIQUES G1054	SINTERED G1380	N° Schéma	G2165
	507293		117	
507143	507230	507154	48	
507094	507231		46	
507104	507242	507157	63	
507104	507242	507157	63	
			11	507382
			11	507382
507095	507232	507155	62	
507104	507242	507157	63	
	507293		117	
507086	507223		9	
507086	507223		9	
507102	507239	507156	3	
507102	507239	507156	3	
507082	507218		70	
	507302		127	
507115	507251	507163	66	
507115	507251	507163	66	
	507293		117	
507082	507218		70	
507144	507281		74	
	507288	507191	92	
	507288	507191	92	
507082	507218		70	
	507292		116	

PLAQUETTES DE FREIN - MÂCHOIRES DE FREIN / BRAKE PADS - BRAKE SHOE

CGN
LE SENS DU DÉTAIL

MOTEUR

CYCLE

PNEUMATIQUE

ATELIER

ACCESSOIRES



ÉLECTRICITÉ

FILTRATION

FREINAGE

TRANSMISSION

Modèle	Cylindre	Depuis	Jusqu'à	GALFER MOTO			N° Schéma	GALFER MOTO Mâchoires avant G2165
				Plaquettes avant				
				SEMI MÉTALLIQUES G1050	SEMI MÉTALLIQUES G1054	SINTERED G1380		
XV 1100 S/SC, VIRAGO	1100	86	92				14	507385
XV 1100 VIRAGO	1100	93	94				14	507385
XV 1100 VIRAGO	1100	95	98				14	507385
XV 125 VIRAGO	125	97	99				20	507391
XV 250 VIRAGO	250	89	90				10	507381
XV 250 VIRAGO	250	93	95				10	507381
XV 250 VIRAGO	250	91	92				10	507381
XV 250 VIRAGO	250	96	0				10	507381
XV 400 VIRAGO	400	88					14	507385
XV 700 L, LC	700	84						
XV 750	750	95						
XV 750 VIRAGO	750	88	92					
XV 750 VIRAGO	750	93						
XVS 125 DRAG STAR	125	0					20	507391
XVS 250 DRAG STAR	250	1					20	507391
XVS 650 DRAG STAR	650	97					14	507385
XVS 650 STAR CLASSIC	650	97					14	507385
XVS 650 STAR SILVERADO	650	97					14	507385
XZ 550 RJ, RK, S	550	82						
YBR 125	125	5	6				20	507391
YBR 125	125	7					20	507391
YBR 125 CUSTOM	125	8					20	507391
YBR 250	250	7					20	507391
YS 125	125	17						
YS 250 FAZER	250	6	10				20	507391
YZ 125	125	85	87					
YZ 250	250	86	87				10	507381
XTZ 750 SUPER TENERE (left)	750	89						
YAMAHA 3 WHEELS								
YTZ 250 N/S	250	85	86	507082	507218			
YT 175 J/K	175	82	83					
YTM 200 EK/EL	200	83	84					
YTM 200 ERN	200	85						
YTM 200 K/L/N	200	83	85					
YAMAHA 4 WHEELS								
YFM 450 GRIZZLY EPS	450	11						
YFM 450 GRIZZLY IRS	450	10						
YFM 660 GRIZZLY	660	2						
YFS 200 U/W/A/B/D/E BLASTER	200	88	2					
YFZ 450 S IZQ.	450	6		507076	507211			
YFM 250 R RAPTOR DER/RIGHT	250	8			507295			
YFM 350	350	87			507295			

 Plaquettes arrière			 Mâchoires arrière	
SEMI MÉTALLIQUES G1050	SEMI MÉTALLIQUES G1054	SINTERED G1380	N° Schéma	G2165
	507292		116	
	507297		122	
507095	507232	507155	62	
507104	507242	507157	63	
507104	507242	507157	63	
	507292		116	
507095	507232	507155	62	
	507292		116	
	507297		122	
507104	507242	507157	63	
507104	507242	507157	63	
507095	507232	507155	62	
507095	507232	507155	62	
507095	507232	507155	62	
507082	507218		70	
507144	507281		74	
507144	507281		74	
507088	507225		31	
507148	507290	507178	58	
507088	507225		31	
	507221		33	
507082	507218		70	
			13	507384
			13	507384
			13	507384
			13	507384
507086	507223		9	
507086	507223		9	
	507295		120	
			13	507384
	507221		33	
507082	507218		70	

PLAQUETTES DE FREIN - MÂCHOIRES DE FREIN / BRAKE PADS - BRAKE SHOE

MOTEUR

CYCLE

PNEUMATIQUE

ATELIER

ACCESSOIRES

ÉLECTRICITÉ

FILTRATION

FREINAGE

TRANSMISSION

Modèle	Cylindre	Depuis	Jusqu'à	GALFER MOTO			GALFER MOTO	
				Plaquettes avant			Mâchoires avant	
				SEMI MÉTALLIQUES G1050	SEMI MÉTALLIQUES G1054	SINTERED G1380	N° Schéma	G2165
YFM 350 R RAPTOR	350	4			507295			
YFM 350 WARRIOR	350	87	88		507295			
YFM 350 WARRIOR	350	89			507295			
YFM 350 WOLVERINE	350	95			507295			
YFM 450	450	3			507295			
YFM 660 R RAPTOR	660	1			507295			
YFS 200 R BLASTER	200	3			507295			
YFZ 450 S IZQ.	450	3	5		507295			
YFZ 350 A,B,D,E BANSHEE	350	90	6	507086	507223			
YFZ 350 T,U,WA,B,D BAN	350	87	89	507086	507223			
YXR 700 RHINO 4X4 DER./RIGHT	700	8			507310			
YXR 700 RHINO 4X4 IZQ./LEFT	700	8			507310			
YFA 1B 125 BREEZE (KIT YAMAHA FR.)	125	91		507116	507252	507164		
YFM 700 R RAPTOR DER./RIGHT	700	13		507132	507269	507185		
YFZ 450 R DER./RIGHT	450	9		507132	507269	507185		
YFZ 450 R/V IZQ.	450	6		507132	507269	507185		
YFM 400 FGW GRIZZLY	400	7		507135	507272			
YFM 450 FW GRIZZLY	450	7		507135	507272			
YFM 450 KODIAK	450	3		507135	507272			
YFM 450 WOLVERINE DER.	450	6		507135	507272			
YFM 400 FWA KODIAK	400	0			507204			
YFM 700 R RAPTOR DER./RIGHT	700	6	12		507204			
YXR 660 RHINO 4X4 DER./RIGHT	660	4			507204			
YF A/W/BREEZE	125	89					10	507381
YFA 1B 125 BREEZE	125	91					10	507381
YFB 250 D/E TIMB	250	92	93					
YFM 200 DX,S,T,U,W	200	86	87				20	507391
YFM 200 N	200	85	89				20	507391
YFM 250	250	1						
YFM 250 BRUIN	250	5	6					
YFM 250 X BEAR TRACKER	250	1						
YFM 350 BRUIN87	350	4						
YFM 350 FGW GRIZZLY	350	7						
YFM 350 FWB BIG BEAR	350	99						
YFM 400 FW BIG BEAR	400	0						
YFM 400 TODOS MODELOS	400	0						
YFM 600 FWA HUNTER	600	1						
YFM 600 GRIZZLY/HUNTING	600	98	1					
YFM BIG BEAR	250	7						
YFA 1D/E	125	92	93					
YFM 350 ERT/ERU	350	87	88					
YFM 450 WOLVERINE IZQ.	450	6						

GALFER MOTO			GALFER MOTO	
Plaquettes arrière			Mâchoires arrière	
SEMI MÉTALLIQUES G1050	SEMI MÉTALLIQUES G1054	SINTERED G1380	N° Schéma	G2165
	507295		120	
507082	507218		70	
507086	507223		9	
507086	507223		9	
	507221		33	
	507295		120	
507086	507223		9	
	507221		33	
507086	507223		9	
507082	507218		70	
	507221		33	
507088	507225		31	
			13	507384
507088	507225		31	
	507221		33	
	507221		33	
	507295		120	
	507295		120	
507086	507223		9	
507088	507225		31	
507086	507223		9	
507088	507225		31	
	507221		33	
			13	507384
			13	507384
			13	507384
			13	507384
			13	507384
507086	507223		9	
507086	507223		9	
507086	507223		9	
507086	507223		9	
	507295		120	
507086	507223		9	
507086	507223		9	
507086	507223		9	
	507295		120	
	507295		120	
507086	507223		9	
			13	507384
			13	507384
	507221		33	

PLAQUETTES DE FREIN - MÂCHOIRES DE FREIN / BRAKE PADS - BRAKE SHOE

CGN
LE SENS DU DÉTAIL

MOTEUR

CYCLE

PNEUMATIQUE

ATELIER

ACCESSOIRES

ÉLECTRICITÉ

FILTRATION

FREINAGE

TRANSMISSION

Modèle	Cylindre	Depuis	Jusqu'à	GALFER MOTO			N° Schéma	Mâchoires avant
				SEMI MÉTALLIQUES G1050	SEMI MÉTALLIQUES G1054	SINTERED G1380		
YFM 700 R RAPTOR IZQ./LEFT	700	6	12					
YFM 700 R RAPTOR IZQ./LEFT	700	13						
YFZ 450 R IZQ./LEFT	450	9						
YFZ 450 R/V DER.	450	6						
YFZ 450 S DER.	450	3	5					
YFZ 450 S DER.	450	6						
YXR 660 RHINO 4X4 IZQ./LEFT	660	4						
YAMAHA BRASIL								
XTZ 250 LANDER	250	7			507310			
XTZ 250 Z TENERE	250	11			507310			
TT R 125	125	8						
TT R 230	230	8						
XTZ 125	125	3						
XTZ 125 X	125	8						
YAMAHA COLOMBIA								
FAZER 160	160							
FZ 16	160							
YAMAHA INDONESIA								
JUPITER MX T 135	135	6		507125	507261			
JUPITER MX KING 150	150	17						
BYSON FZ 16	125	10						
JUPITER MX T 135 HC	135	6	10					
JUPITER MX T 135 SE	135	6						
JUPITER MX T 135 SEC	135	8						
RX - KING RXK 135	135	2						
SCORPIO SX 4	223	1						
SCORPIO Z SX	223	12						
SCORPIO Z SX 4	223	5						
V - IXION FZ 150	150	7						
XENON AL 125	125	10						
XENON AL 125 C	125	11						
YAMAHA MALASIA								
R 15	150	14		507125	507261			
Y 15 ZR	150	17						
125 ZR	125	12						
135 LC	135	11						
135 LC ES	135	11						
EGO LC 125	125	11						
FZ 150i	150	11						
NUOVO LC	135	12						
YAMAHA VIETNAM								
Y 15 ZR	150	17						

GALFER MOTO			GALFER MOTO	
Plaquettes arrière			Mâchoires arrière	
SEMI MÉTALLIQUES G1050	SEMI MÉTALLIQUES G1054	SINTERED G1380	N° Schéma	G2165
	507221		33	
	507221		33	
507088	507225		31	
507088	507225		31	
507088	507225		31	
507088	507225		31	
507088	507225		31	
	507221		33	
	507221		33	
	507302		127	
	507221		33	
	507221		33	
	507221		33	
507143	507230	507154	48	
507143	507230	507154	48	
507144	507281		74	
507148	507290	507178	58	
507144	507281		74	
507144	507281		74	
507144	507281		74	
507144	507281		74	
507115	507251	507163	66	
507115	507251	507163	66	
507115	507251	507163	66	
507115	507251	507163	66	
507144	507281		74	
507144	507281		74	
507144	507281		74	
507144	507281		74	
507148	507290	507178	58	
507144	507281		74	
507144	507281		74	
507115	507251	507163	66	
507144	507281		74	
507144	507281		74	
507148	507290	507178	58	

PLAQUETTES DE FREIN - MÂCHOIRES DE FREIN / BRAKE PADS - BRAKE SHOE

Modèle	Cylindre	Depuis	Jusqu'à	GALFER MOTO			N° Schéma	Mâchoires avant
				SEMI MÉTALLIQUES G1050	SEMI MÉTALLIQUES G1054	SINTERED G1380		
ZERO								
ZERO DS	EL	10	14	507085	507222	507152		
ZERO MX	EL	10	12	507085	507222	507152		
ZERO S	EL	10	12	507085	507222	507152		
ZERO X	EL	10		507085	507222	507152		
ZERO XU	EL	10	12	507085	507222	507152		
ZERO FX STEALTHFIGHTER	EL	14			507305			
ZERO S STREETFIGHTER	EL	14	14		507305			
ZERO DSR/X	EL	22		507143	507230	507154		
ZERO DS	EL	15	20		507320			
ZERO DS	EL	21			507320			
ZERO DSR	EL	21			507320			
ZERO FX	EL	20			507320			
ZERO FXE 7.2	EL	22			507320			
ZERO FXS	EL	21			507320			
ZERO S	EL	15	20		507320			
ZERO S	EL	21			507320			
ZERO S STREETFIGHTER	EL	15			507320			
ZERO SR	EL	20	20		507320			
ZERO SR	EL	21			507320			
ZERO SR/F	EL	21			507320			
ZERO SR/R	EL	21			507320			
ZERO DS DUAL SPORT	EL	13			507356			
ZERO DSR BLACK FOREST	EL	21			507356			
ZERO FX STEALTHFIGHTER	EL	13	13		507356			
ZERO MX	EL	13			507356			
ZERO S	EL	13	13		507356			
ZERO S	EL	14	14		507356			
ZERO S STREETFIGHTER	EL	13	13		507356			
ZERO XU URBAN CROSSER	EL	13			507356			
ZONTES								
M310	310	21			507305			
R310	310	18			507305			
S - 250	250	18			507305			
X310	310	18			507305			
T310	310	20			507305			
V310	310	20			507305			
ZUNDAPP								
KS 125	125	82						
KS 175	175	82						

PLAQUETTES DE FREIN - MÂCHOIRES DE FREIN / BRAKE PADS - BRAKE SHOE

MOTEUR

CYCLE

PNEUMATIQUE

ATELIER

ACCESSOIRES

ÉLECTRICITÉ

FILTRATION

FREINAGE

TRANSMISSION



Schéma N°1



Schéma N°7



Schéma N°2

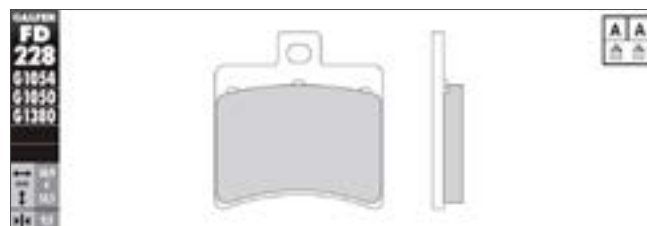

Schéma N°9

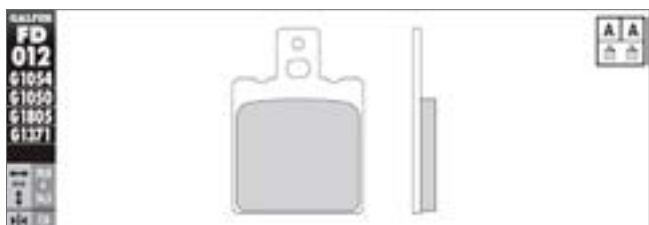

Schéma N°3

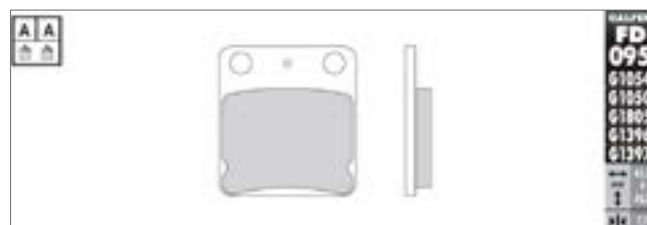

Schéma N°11



Schéma N°4

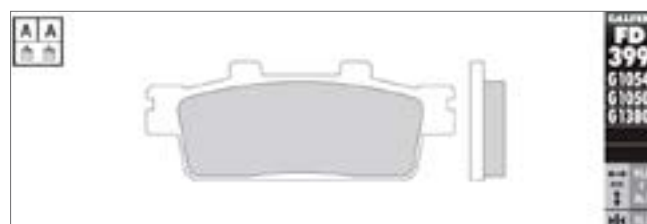

Schéma N°12



Schéma N°5

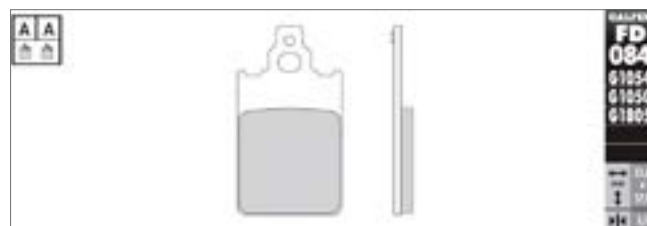

Schéma N°13



Schéma N°6

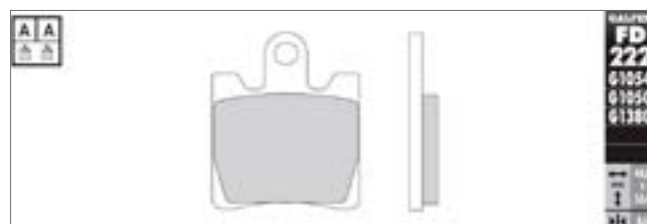

Schéma N°14



Schéma N°16



Schéma N°22

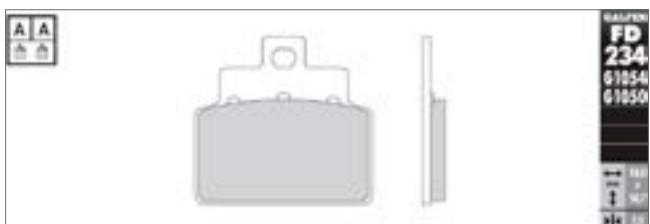

Schéma N°17

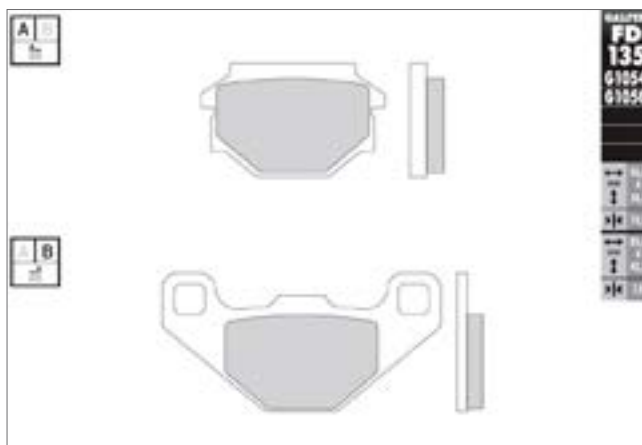

Schéma N°18

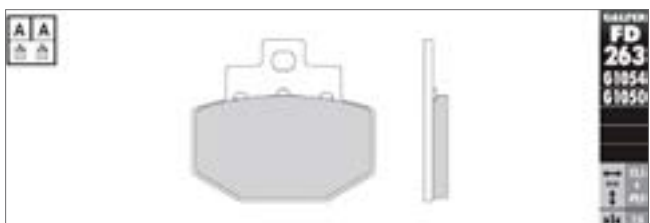

Schéma N°23



Schéma N°19

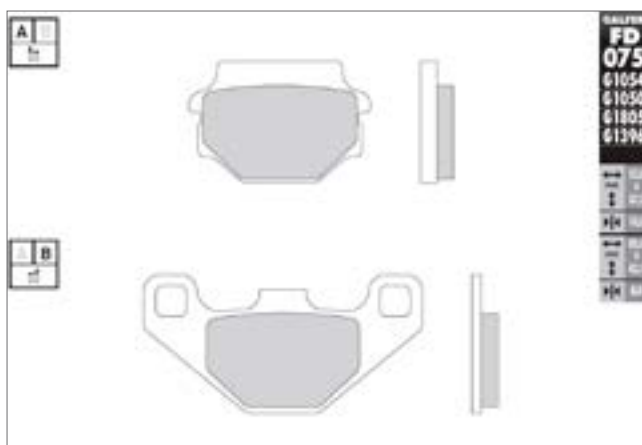

Schéma N°20

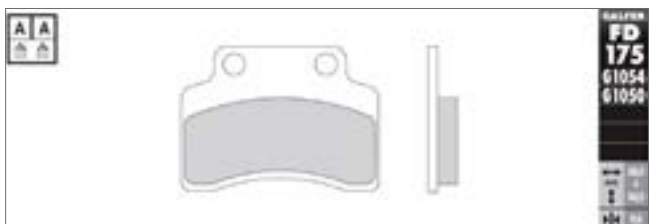

Schéma N°24



Schéma N°21

PLAQUETTES DE FREIN - MÂCHOIRES DE FREIN / BRAKE PADS - BRAKE SHOE

MOTEUR

CYCLE

PNEUMATIQUE

ATELIER

ACCESSOIRES

ÉLECTRICITÉ

FILTRATION

FREINAGE

TRANSMISSION



Schéma N°25



Schéma N°29

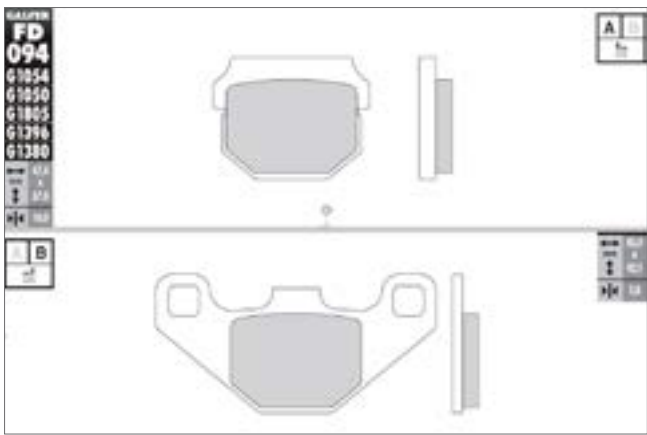

Schéma N°26

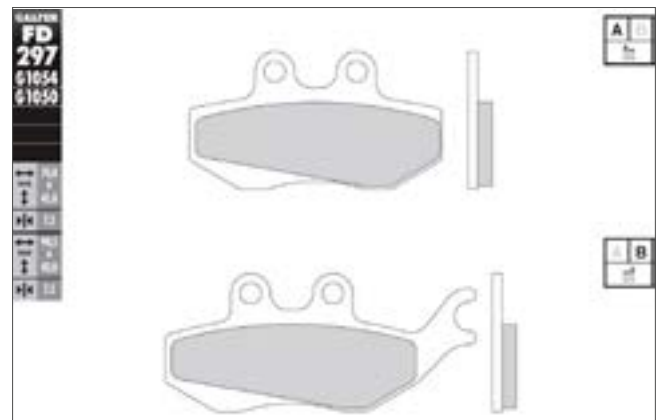

Schéma N°30



Schéma N°29



Schéma N°29

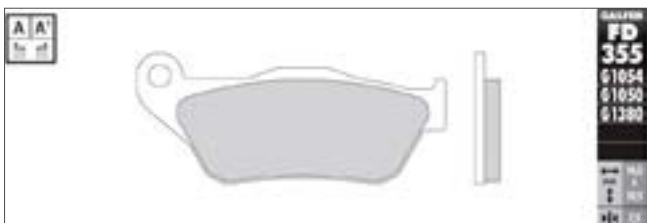

Schéma N°31



Schéma N°33



Schéma N°37



Schéma N°34

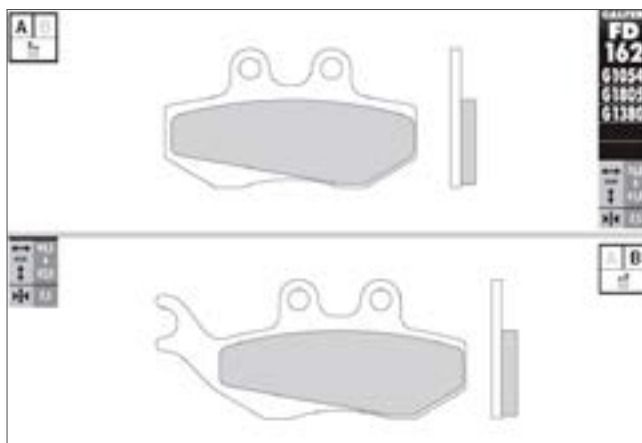

Schéma N°38



Schéma N°39

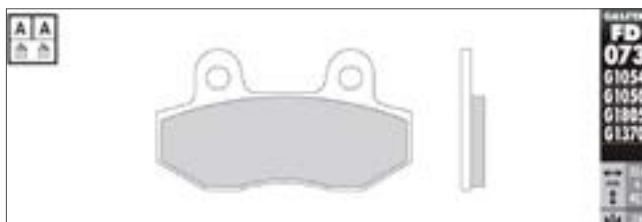

Schéma N°35



Schéma N°40



Schéma N°44

PLAQUETTES DE FREIN - MÂCHOIRES DE FREIN / BRAKE PADS - BRAKE SHOE

MOTEUR

CYCLE

PNEUMATIQUE

ATELIER

ACCESSOIRES

ÉLECTRICITÉ

FILTRATION

FREINAGE

TRANSMISSION



Schéma N°46



Schéma N°53



Schéma N°48



Schéma N°54



Schéma N°49

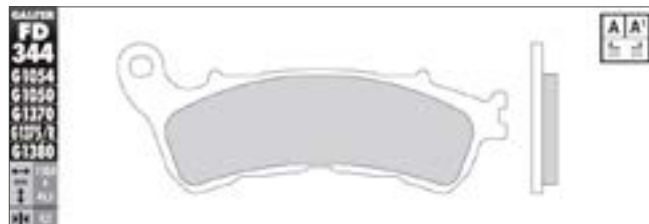

Schéma N°56

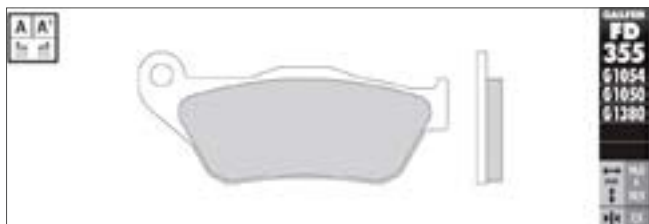

Schéma N°50

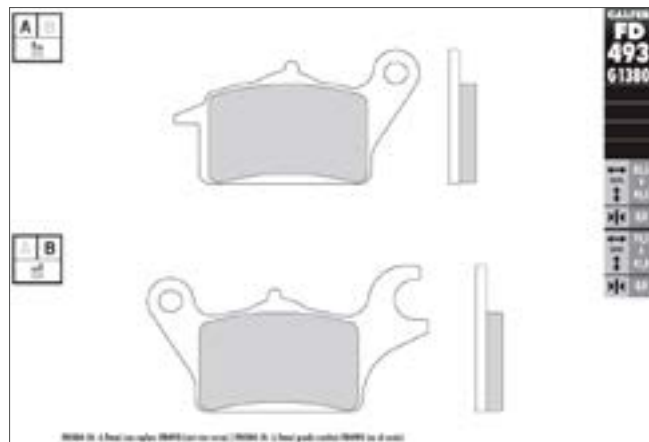

Schéma N°57



Schéma N°51



Schéma N°58

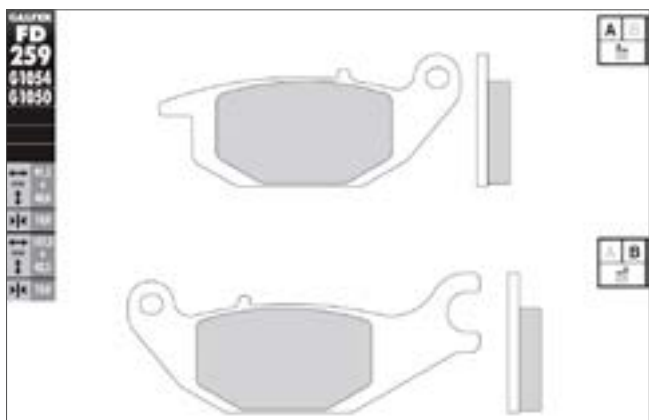

Schéma N°59



Schéma N°64

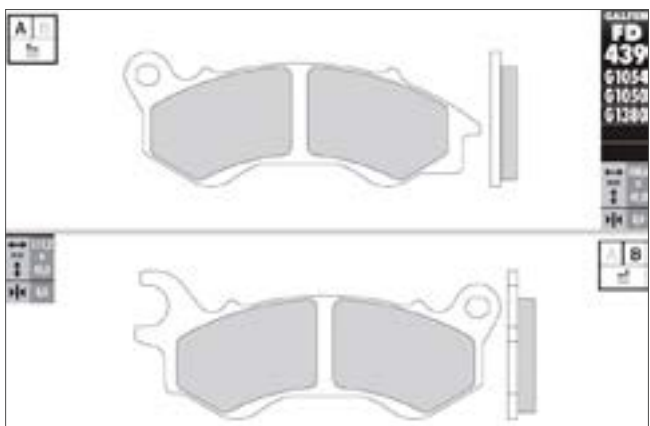

Schéma N°60

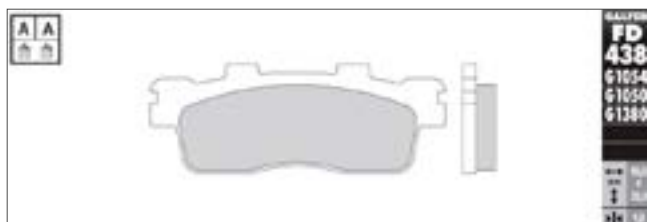

Schéma N°66

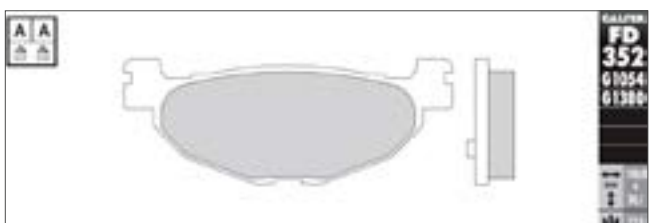

Schéma N°61



Schéma N°68

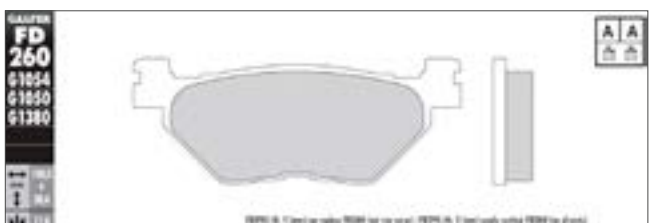

Schéma N°62

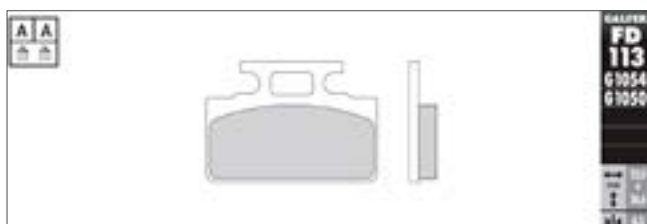

Schéma N°69



Schéma N°63

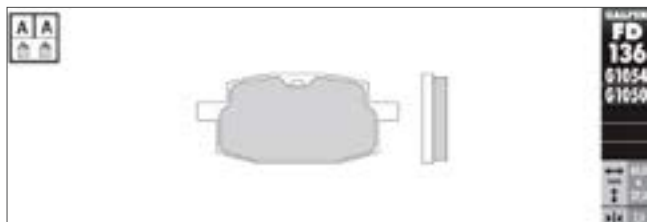

Schéma N°70

PLAQUETTES DE FREIN - MÂCHOIRES DE FREIN / BRAKE PADS - BRAKE SHOE

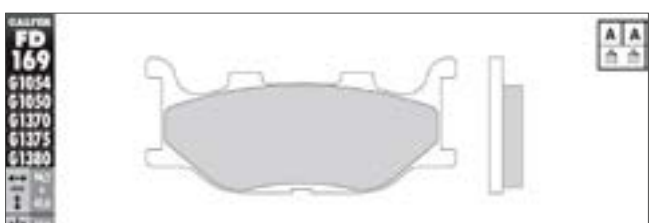
MOTEUR

CYCLE

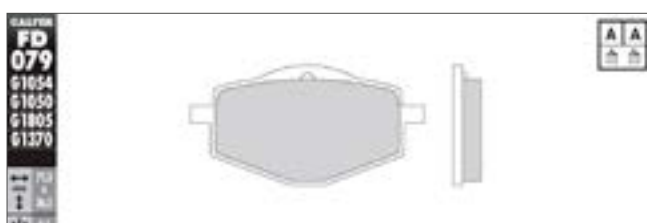
PNEUMATIQUE

ATELIER

ACCESSOIRES

ÉLECTRICITÉ

FILTRATION

FREINAGE

TRANSMISSION



Schéma N°74



Schéma N°81

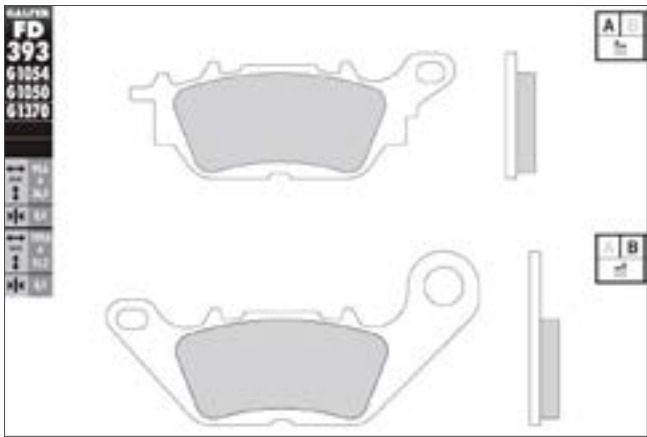

Schéma N°77

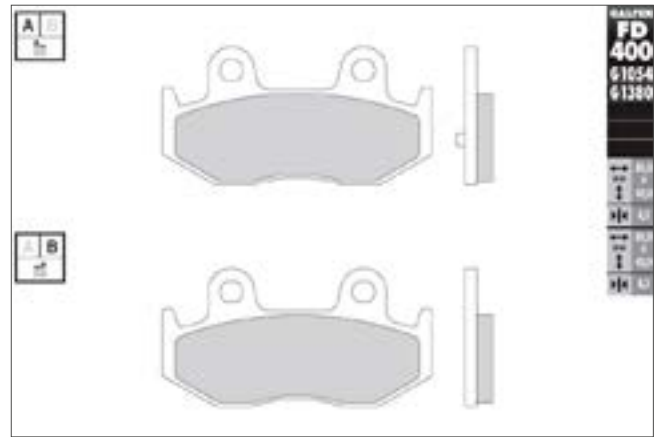

Schéma N°82

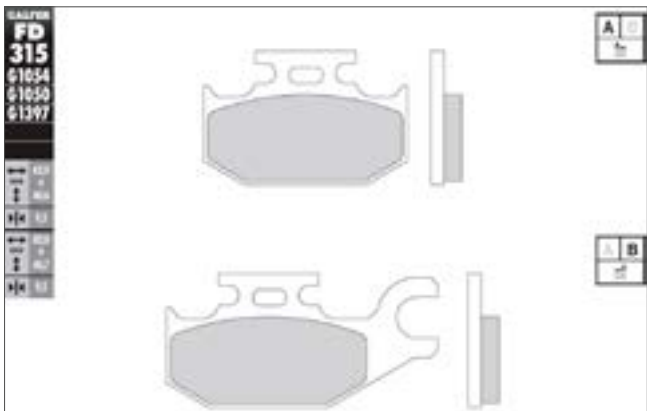

Schéma N°78

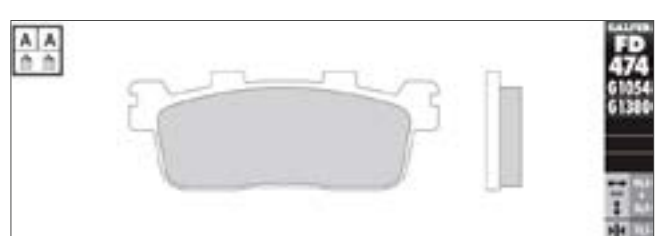

Schéma N°83

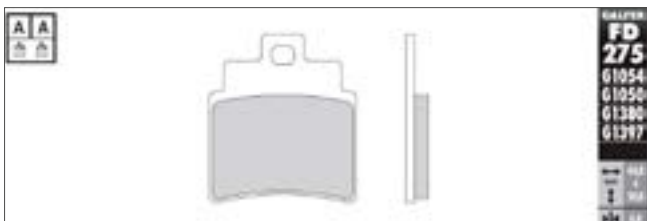

Schéma N°79



Schéma N°86



Schéma N°87

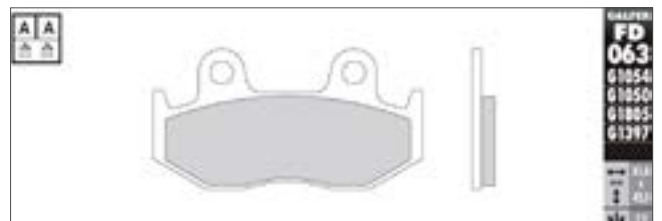

Schéma N°88



Schéma N°95



Schéma N°90



Schéma N°96



Schéma N°91



Schéma N°99

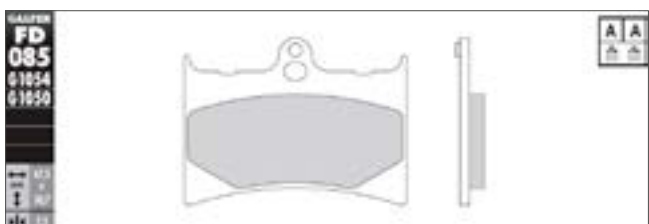

Schéma N°92

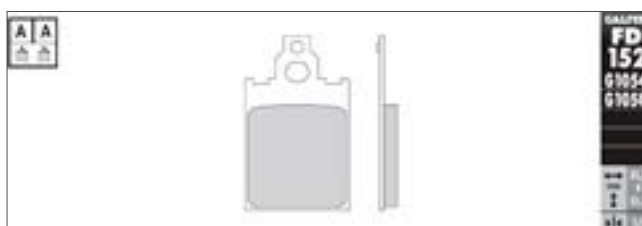

Schéma N°100

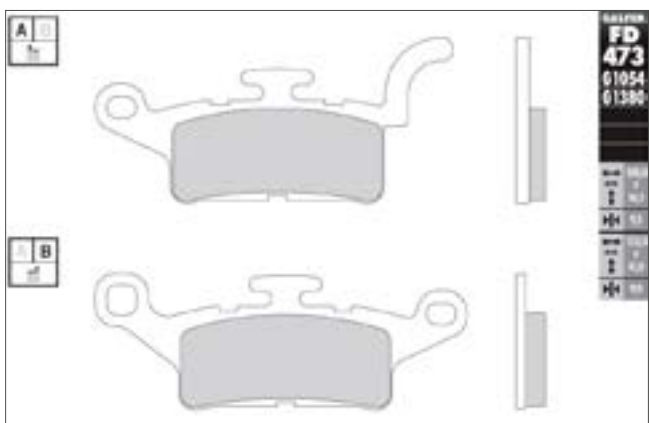

Schéma N°93



Schéma N°101

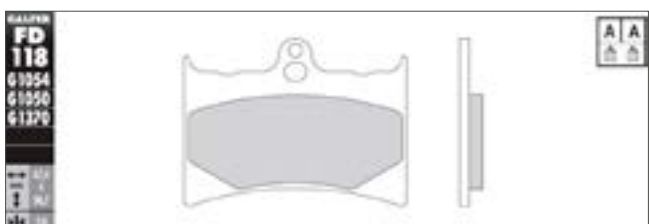

Schéma N°102

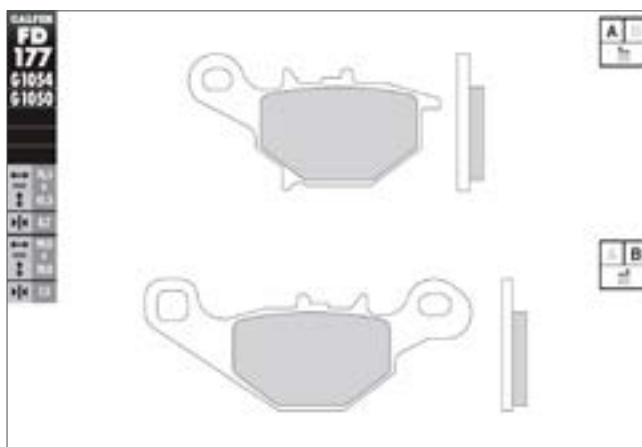

Schéma N°108

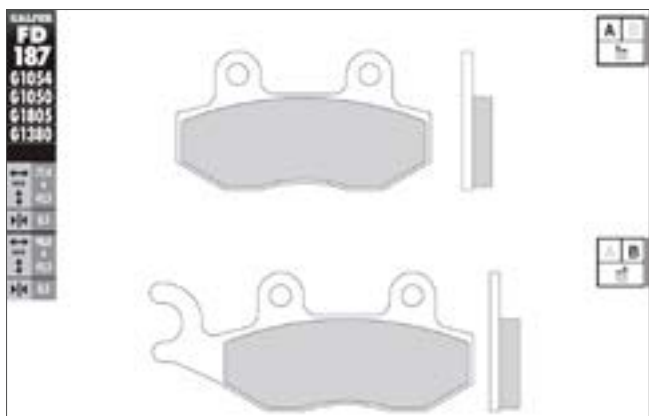

Schéma N°103

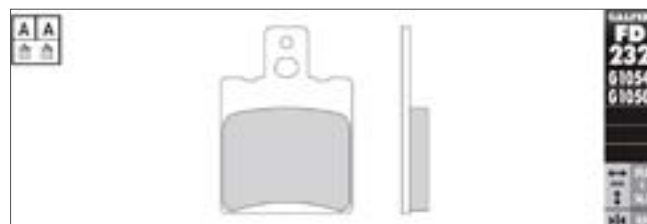

Schéma N°109



Schéma N°105



Schéma N°110

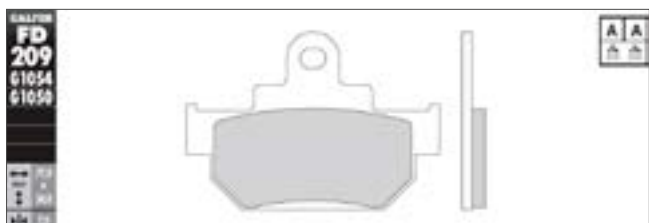

Schéma N°106



Schéma N°111

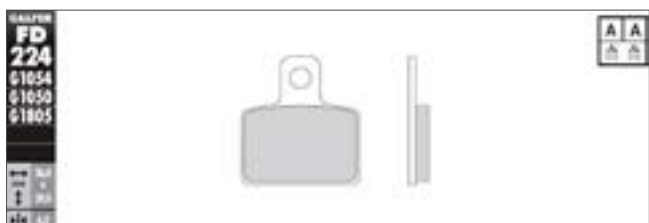

Schéma N°107

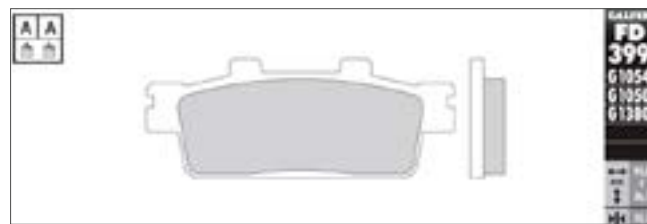

Schéma N°113



Schéma N°115

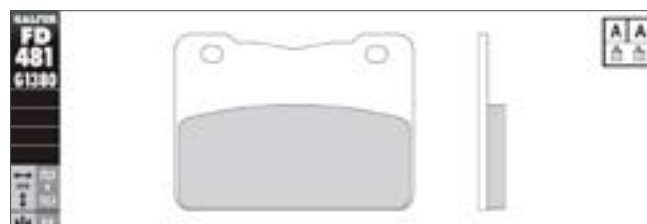

Schéma N°116

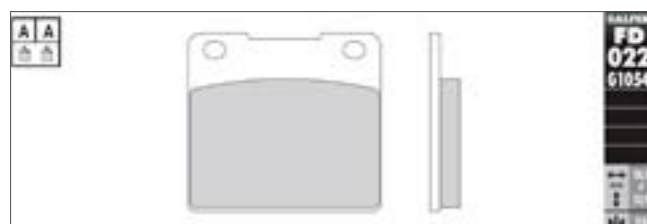

Schéma N°122



Schéma N°117



Schéma N°123



Schéma N°118



Schéma N°124

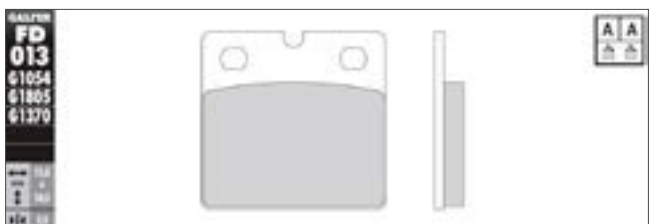

Schéma N°119

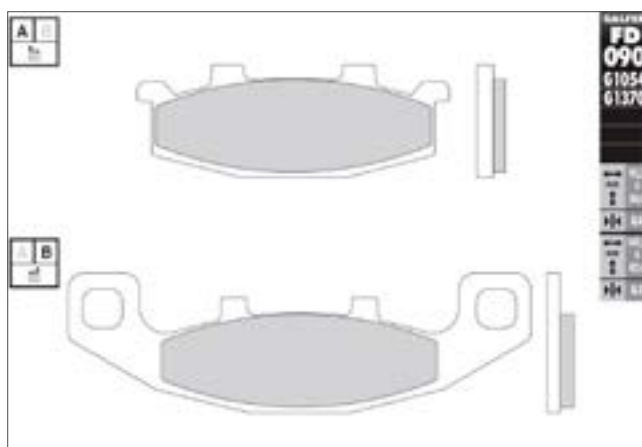

Schéma N°125

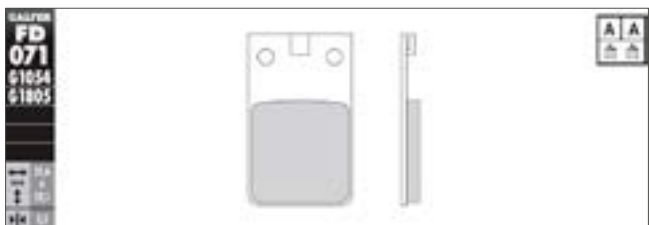

Schéma N°120



Schéma N°121

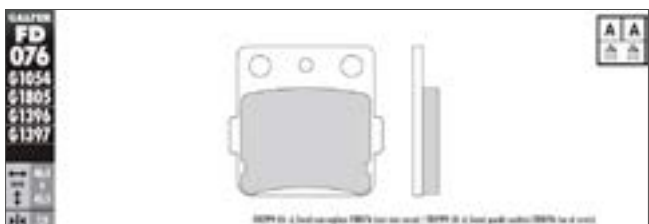

Schéma N°126

PLAQUETTES DE FREIN - MÂCHOIRES DE FREIN / BRAKE PADS - BRAKE SHOE

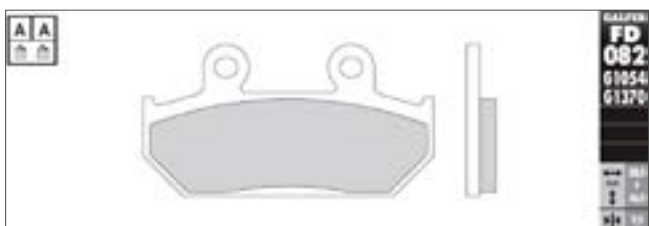
MOTEUR

CYCLE

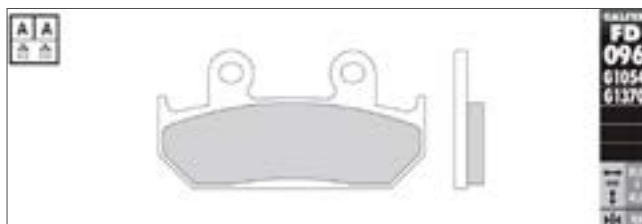
PNEUMATIQUE

ATELIER

ACCESSOIRES

ÉLECTRICITÉ

FILTRATION

FREINAGE

TRANSMISSION



Schéma N°127



Schéma N°132

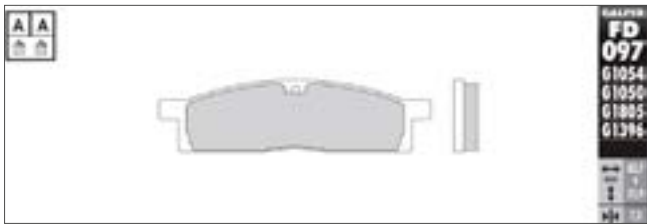

Schéma N°128

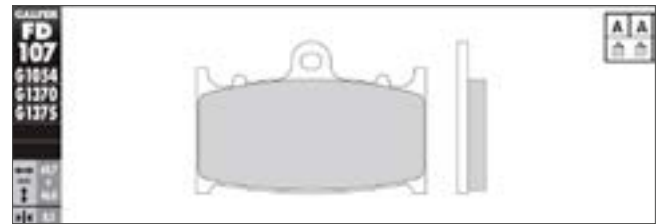

Schéma N°133

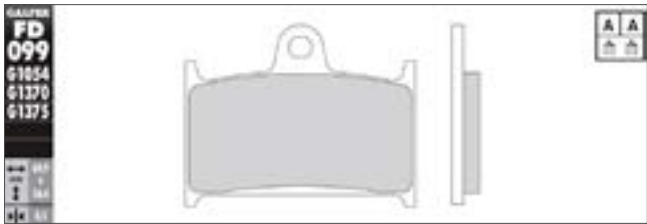

Schéma N°129

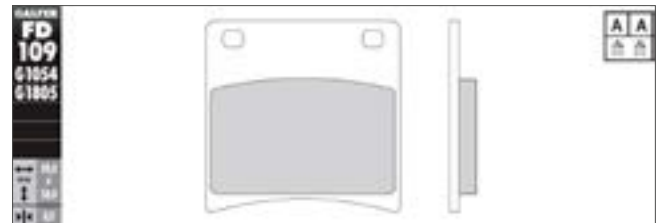

Schéma N°134

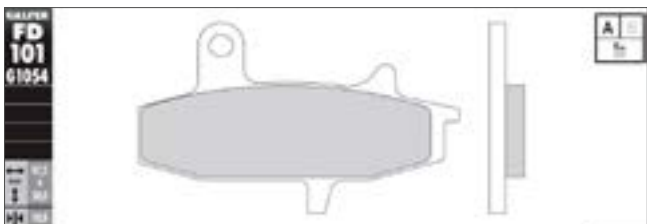

Schéma N°130

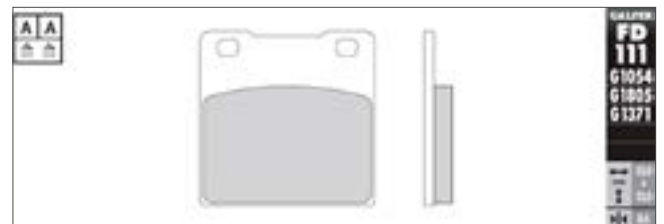

Schéma N°134



Schéma N°130



Schéma N°134



Schéma N°131

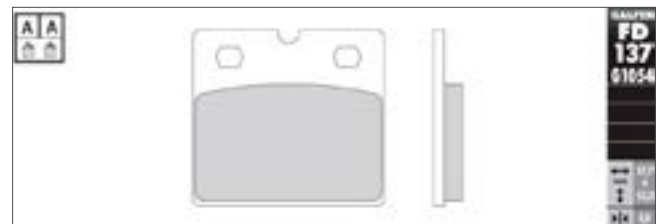

Schéma N°135

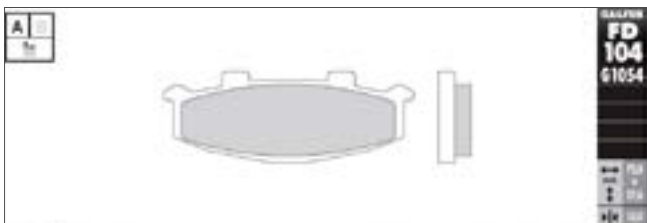

Schéma N°136

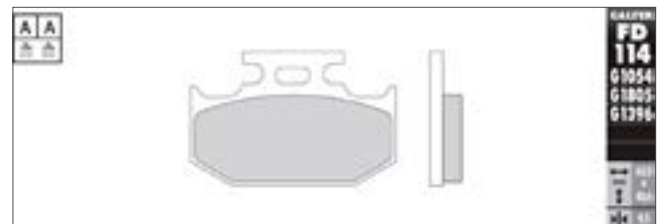

Schéma N°143



Schéma N°139

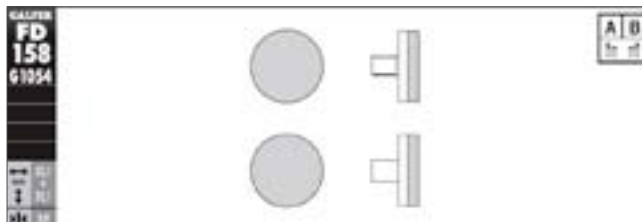

Schéma N°144



Schéma N°145

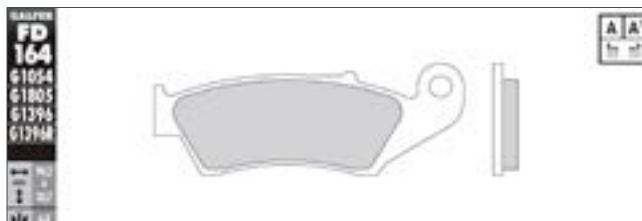

Schéma N°140



Schéma N°146



Schéma N°141

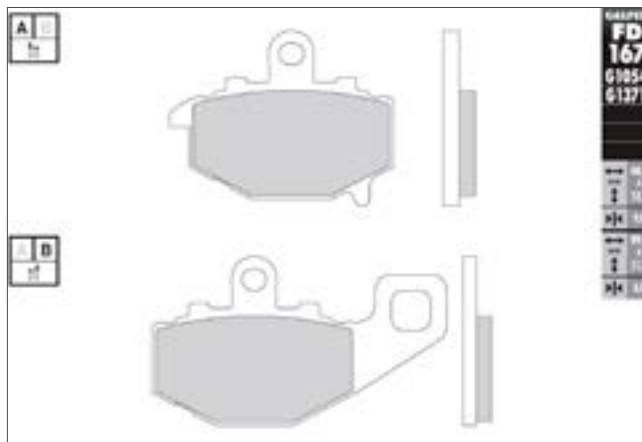

Schéma N°142



Schéma N°147

MOTEUR

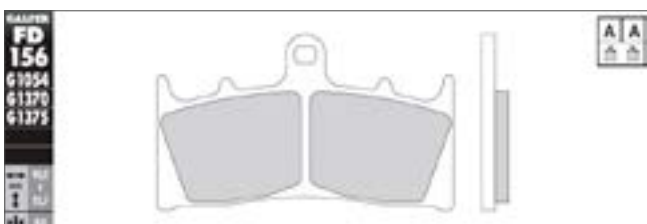
CYCLE

PNEUMATIQUE

ATELIER

ACCESSOIRES

ÉLECTRICITÉ

FILTRATION

FREINAGE

TRANSMISSION



Schéma N°148



Schéma N°149

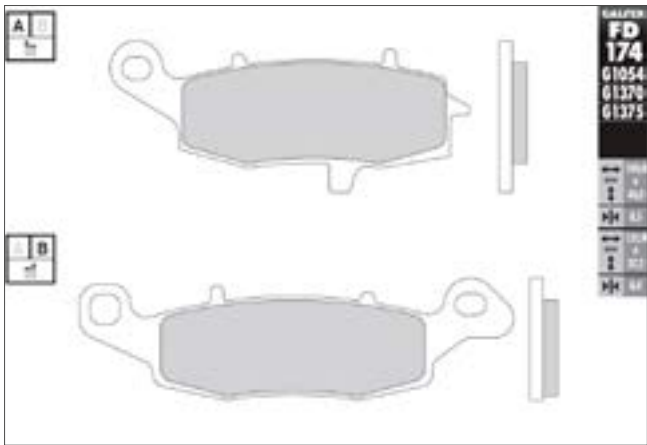

Schéma N°150



Schéma N°151

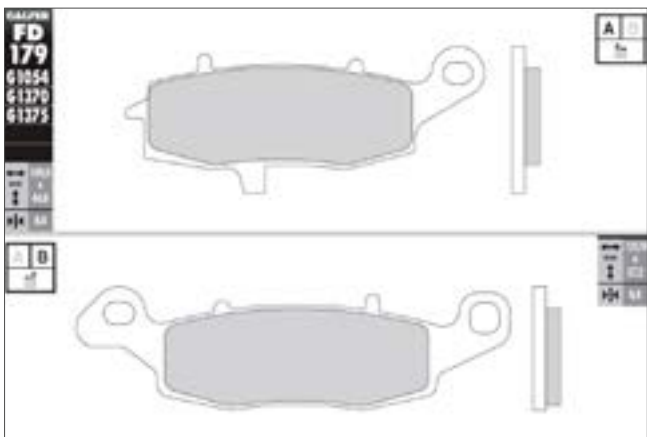

Schéma N°152



Schéma N°153



Schéma N°154

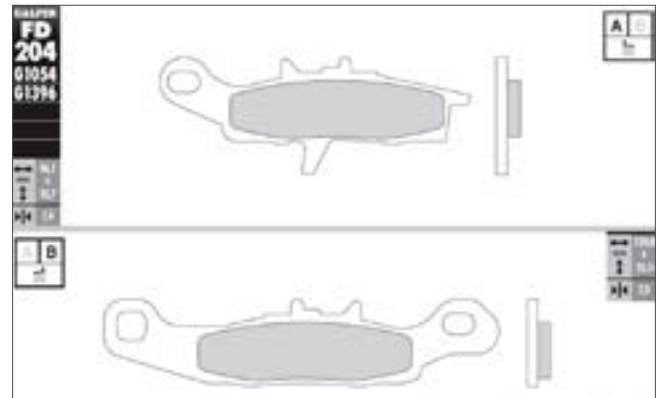

Schéma N°156

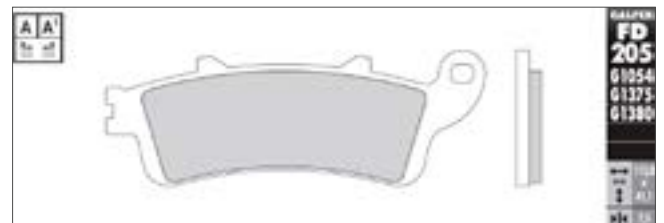

Schéma N°157



Schéma N°158

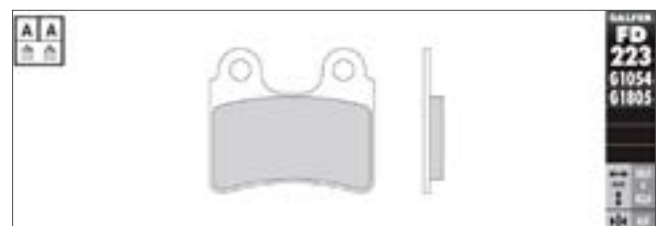

Schéma N°166



Schéma N°159

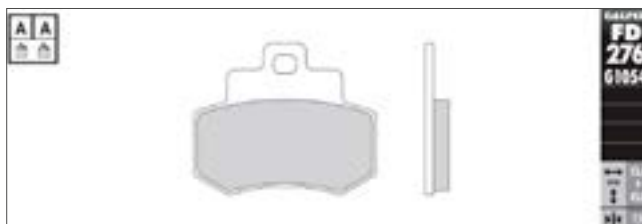

Schéma N°167



Schéma N°161



Schéma N°168



Schéma N°163



Schéma N°169



Schéma N°164

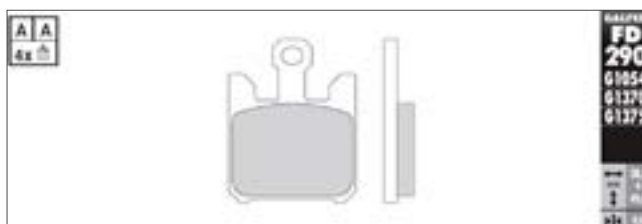

Schéma N°170



Schéma N°165



Schéma N°171

MOTEUR

CYCLE

PNEUMATIQUE

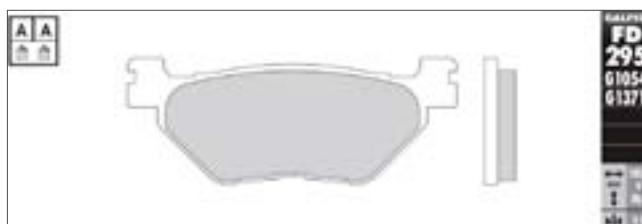
ATELIER

ACCESSOIRES

ÉLECTRICITÉ

FILTRATION

FREINAGE

TRANSMISSION



Schéma N°172



Schéma N°178

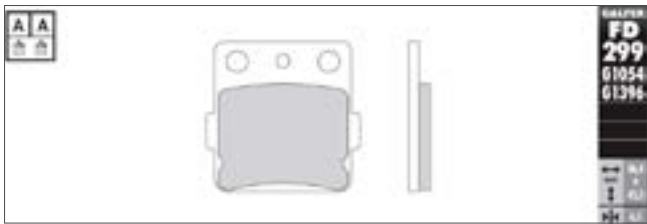

Schéma N°173



Schéma N°179

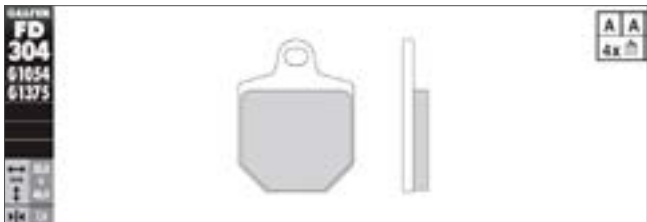

Schéma N°174

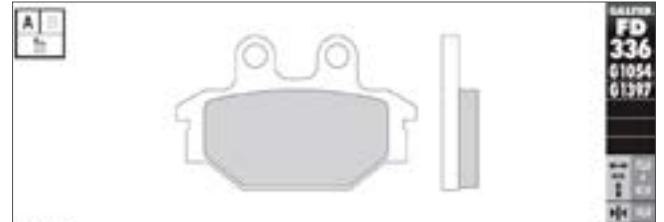

Schéma N°180

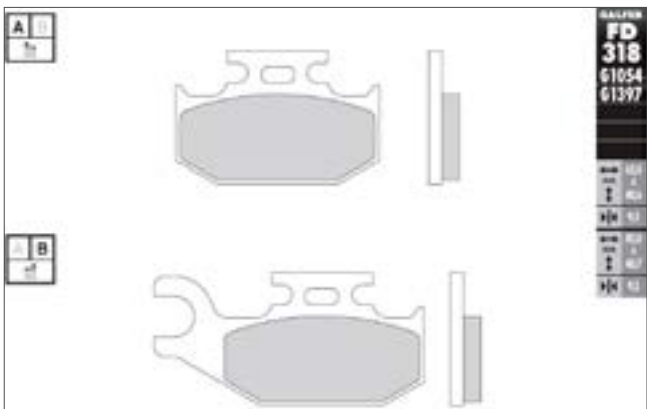

Schéma N°175



Schéma N°182



Schéma N°177



Schéma N°183



Schéma N°184



Schéma N°185



Schéma N°186

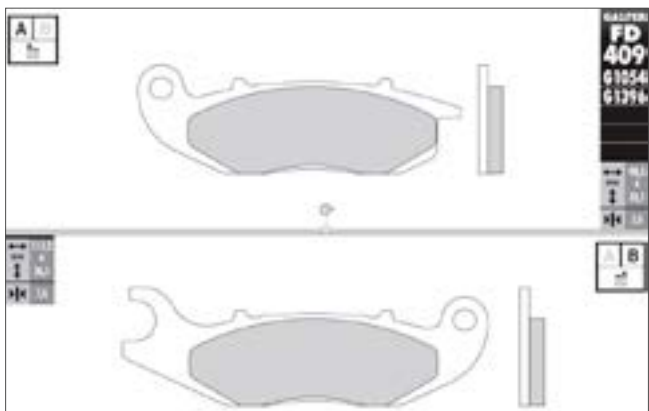

Schéma N°187

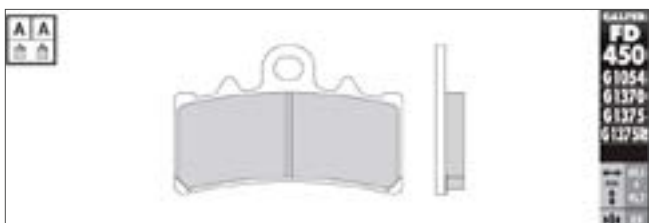

Schéma N°188



Schéma N°189

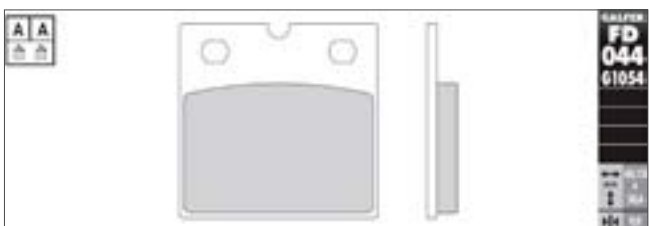

Schéma N°190

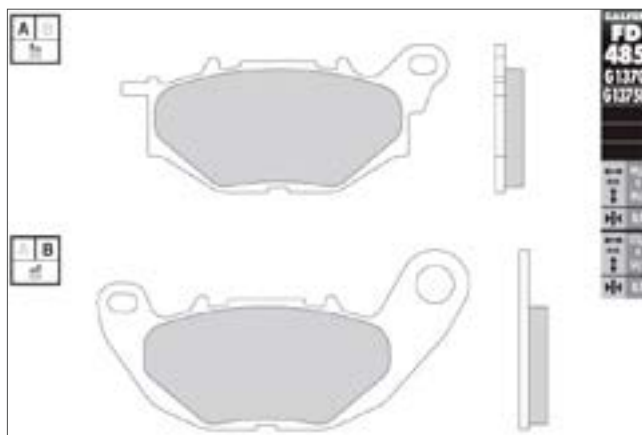

Schéma N°191

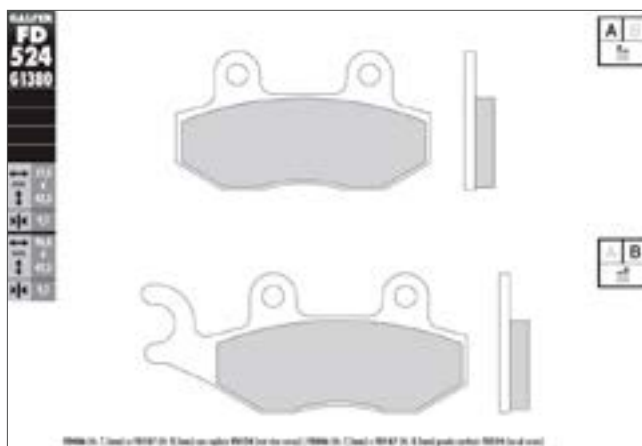

Schéma N°192

PLAQUETTES DE FREIN - MÂCHOIRES DE FREIN / BRAKE PADS - BRAKE SHOE

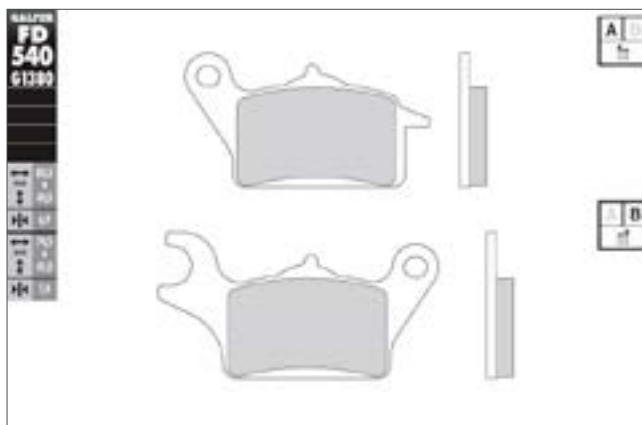

Schéma N°193



Schéma N°2



Schéma N°3



Schéma N°4



Schéma N°5



Schéma N°7



Schéma N°9



Schéma N°11



Schéma N°13



Schéma N°14



Schéma N°16



Schéma N°17



Schéma N°19



Schéma N°20

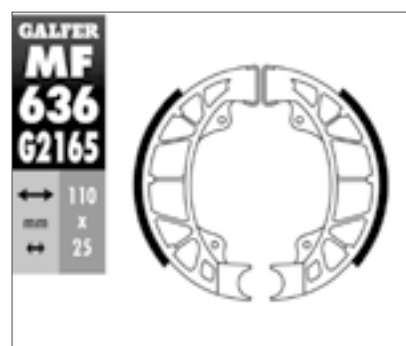

Schéma N°22



Schéma N°25

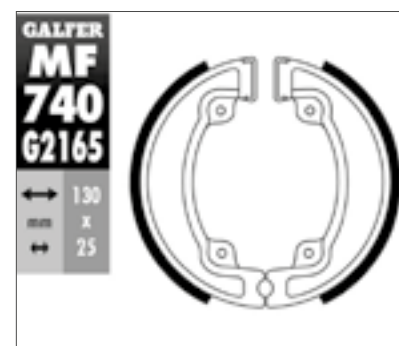

Schéma N°25

MOTEUR

CYCLE

PNEUMATIQUE

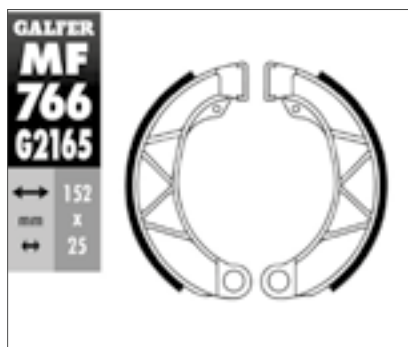
ATELIER

ACCESSOIRES

ÉLECTRICITÉ

FILTRATION

FREINAGE

TRANSMISSION





/ COURROIE / BELT
/ KIT CHAÎNE / CHAIN KIT



1172
1201



COURROIES

Modèle	Cylindre	Année début	Année fin			
APRILIA						
LEONARDO	125	-	-	478102	-	-
LEONARDO	125	-	-	-	-	480735
LEONARDO	150	-	-	-	-	480735
MOJITO	125	-	-	-	-	-
SCARABEO LIGHT	125	-	-	478102	-	-
SCARABEO LIGHT	125	-	-	-	-	480735
SCARABEO LIGHT	150	-	-	-	-	480735
SPORTCITY CUBE	125	2015	-	-	489953	-
SR MAX	125	2015	2017	-	478095	-
SR MAX	300	2015	-	-	494758	-
SR MOTARD	125	2015	2015	-	478095	-
SRV	850	-	-	-	496640	-
SRV	850	2015	2018	-	496640	-
BENELLI						
ADIVA	125	-	-	-	-	-
ADIVA	150	-	-	-	-	-
BETA						
EIKON	125	-	-	-	-	480735
EIKON	150	-	-	-	-	480735
BMW						
C 600 SPORT	600	2015	-	-	489954	-
C SPORT	600	-	-	-	-	485496
C600	600	2012	-	-	489954	-
C650 GT	650	-	-	-	-	485496
C650 GT	650	2012	-	-	489954	-
C650 GT	650	2015	2020	-	489954	-
C650 SPORT	650	-	-	-	-	485496
C650 SPORT	650	2016	2020	-	489954	-
DAELIM						
BESBI	125	2015	2019	478100	-	-
OTELLO	125	-	-	-	496633	-
S1	125	-	-	-	496633	-
S2	125	-	-	-	496633	-
S2	125	2015	-	-	496633	-
S3 TOURING	125	2012	2017	496645	-	-
S3 TOURING	125	2015	2017	496645	-	-
DERBI						
BOULEVARD	125	-	-	-	-	-
BOULEVARD	125	2015	-	-	478095	-
BOULEVARD	150	-	-	-	-	-
GPI	125	-	-	-	-	-



COURROIES

Modèle	Cylindre	Année début	Année fin			
GILERA						
DNA 4T	125	-	-	-	-	-
FUOCO	500	2015	2016	496634	-	-
GP800	800	-	-	496640	-	-
NEXUS	125	2007	-	-	-	-
RUNNER	180	-	-	512706	-	-
RUNNER 4T	125	-	-	461958	-	-
RUNNER VX-VXR 4T	125	-	-	-	-	-
HONDA						
DYLAN	125	2002	2007	496645	-	-
FES PANTHEON 2T	150	1998	2002	496645	-	-
FES PANTHEON 4T	125	-	-	485367	-	-
FES PANTHEON 4T	125	2003	2006	496645	-	-
FES PANTHEON 4T	150	2003	2006	496645	-	-
FES S-WING	125	2007	2013	496645	-	-
FES S-WING	150	2007	2013	496645	-	-
FORZA	125	-	-	494755	-	-
NES 125 4T	125	2000	2002	496645	-	-
NSS FORZA	125	2015	2020	494755	-	-
NSS FORZA	250	2005	2007	509372	-	-
PCX	125	-	-	485287	-	-
PCX	125	2018	2020	512692	-	-
PCX	150	2018	2020	512692	-	-
PES INJECTION	125	2007	2013	496645	-	-
SES DYLAN	150	2002	2004	496645	-	-
SH	125	-	-	485367	-	-
SH	125	2001	2010	496645	-	-
SH A	125	2015	2020	490549	-	-
SH i	125	2013	-	490549	-	-
SH I	125	2015	2020	490549	-	-
SH MODE	125	2015	2017	512694	-	-
ITALJET						
JET SET	125	-	-	-	-	-
JET SET	150	-	-	-	-	-
TORPEDO	125	-	-	-	-	-
TORPEDO	150	-	-	-	-	-
KAWASAKI						
J	125	2015	2020	-	489955	-
J	300	-	-	-	490550	-
J	300	2015	-	-	490550	-
J 300 ABS	300	2015	2020	-	490550	-
KEEWAY						
ARN	125	-	-	-	-	-



COURROIES				OEM
475647	-	-	-	-
-	-	-	-	-
-	-	-	-	-
475647	-	-	-	-
-	-	-	-	-
-	-	-	-	-
475647	-	-	-	-
-	-	-	-	-
-	-	-	-	-
-	-	-	-	-
-	-	-	-	-
-	-	-	-	-
-	-	-	-	-
-	-	-	-	-
-	-	-	-	-
-	-	-	-	-
-	-	-	-	-
-	-	-	-	-
-	-	-	-	-
-	-	-	-	-
-	-	-	-	-
-	-	-	-	-
-	-	-	-	-
-	-	-	-	-
-	-	-	-	-
-	-	-	-	-
-	-	-	-	-
-	-	-	-	-
475647	-	-	-	-
475647	-	-	-	-
475647	-	-	-	-
475647	-	-	-	-
-	-	-	-	-
-	-	-	-	-
-	-	-	-	-
-	-	-	-	-
-	-	-	-	-
-	-	-	468860	-



COURROIES

Modèle	Cylindre	Année début	Année fin			
MATRIX	125	-	-	-	-	-
KREIDLER						
FLORETT	125	-	-	-	-	-
KYMCO						
AGILITY	125	-	-	-	-	-
AGILITY	125	-	-	494756	-	-
AGILITY	150	2015	-	494756	-	-
AGILITY CARRY 4T	125	2015	2020	494756	-	-
AGILITY PLUS	125	2015	-	494756	-	-
AGILITY R16	125	-	-	-	-	-
AGILITY R16	125	-	-	494756	-	-
AGILITY R16	125	2016	2020	494756	-	-
AGILITY RS	125	-	-	-	-	-
AGILITY RS	125	2015	-	494756	-	-
AK	550	-	-	-	-	506869
AK	550	2017	2020	512695	-	-
B&W	125	-	-	-	-	480735
B&W	125	-	-	-	496639	-
B&W	150	-	-	-	-	480735
B&W	150	-	-	-	496639	-
DINK	125	-	-	478102	-	-
DINK	125	-	-	-	-	480735
DINK	125	-	-	-	-	-
DINK	125	-	-	-	496639	-
DINK LC	150	-	-	-	-	480735
DINK LC	150	-	-	-	496639	-
DINK STREET	125	2010	-	-	489955	-
DINK STREET	125	2015	-	-	489955	-
DINK STREET i	300	-	-	-	490550	-
DOWNTOWN	300	-	-	-	490550	-
DOWNTOWN ABS	300	2015	2016	-	490550	-
DOWNTOWN I	125	2016	2020	-	489955	-
DOWNTOWN I	300	2015	-	-	490550	-
DOWNTOWN I	350	2015	2020	-	490550	-
GRAND DINK	125	-	-	-	-	480735
GRAND DINK	125	-	-	-	-	-
HEROISM	125	-	-	478100	-	-
K-XCT I	125	2015	-	-	489955	-
K-XCT I	300	2015	2017	-	490550	-
LIKE	125	-	-	-	-	-
LIKE LX	125	2015	-	494756	-	-
MOVIE	125	-	-	-	-	-
MOVIE	125	2015	-	494756	-	-



COURROIES				OEM
-	-	-	468860	-
-	-	-	468860	-
-	-	-	492216	-
-	-	-	-	-
-	-	-	-	-
-	-	-	-	-
-	-	-	-	-
-	-	-	468860	-
-	-	-	-	-
-	-	-	-	-
-	-	-	468860	-
-	-	-	-	-
-	-	-	-	-
-	-	-	-	-
-	-	-	-	-
-	-	-	-	-
-	-	-	-	-
-	-	-	-	-
-	-	-	-	-
-	-	-	-	-
-	-	-	485669	-
-	-	-	-	-
-	-	-	-	-
-	-	-	-	-
-	-	-	-	-
-	-	-	-	-
-	-	-	-	-
-	-	-	-	-
-	-	-	-	-
-	-	-	-	-
-	-	-	-	-
-	-	-	485669	-
-	-	-	-	-
-	-	-	-	-
-	-	-	-	-
-	-	-	468860	-
-	-	-	-	-
-	-	-	492216	-
-	-	-	-	-



COURROIES

Modèle	Cylindre	Année début	Année fin			
PEOPLE 2T	125	-	-	-	-	-
PEOPLE 2T	125	-	-	494756	-	-
PEOPLE 4T	125	2015	-	494756	-	-
PEOPLE GTI	125	2012	-	-	489955	-
PEOPLE GTI	125	2015	-	-	489955	-
PEOPLE GTI	300	2015	-	-	490550	-
PEOPLE ONE I	125	2015	-	494756	-	-
PEOPLE S 2T	125	2015	-	494756	-	-
PEOPLE S 4T	125	-	-	-	-	-
SUPER 8	125	-	-	-	-	-
SUPER 8 4T	125	-	-	-	-	-
X-CITING I	400	2015	2017	-	496642	-
X-TOWN	125	2016	2019	-	489955	-
XCITING S	400	2018	2019	-	496642	-
MALAGUTI						
CENTRO	125	2007	2013	496645	-	-
CENTRO	160	2007	2010	496645	-	-
CIAK	125	-	-	-	-	-
F18 WARRIOR	150	-	-	-	-	480735
MADISON	125	-	-	-	450218	-
MADISON	125	-	-	-	-	-
MADISON 3	125	-	-	-	-	-
MBK						
CITYLINER	125	2018	-	-	-	-
EVOLIS	125	2014	2016	-	478097	-
EVOLIS	125	-	-	-	-	-
EVOLIS	125	-	-	497259	-	-
EVOLIS ABS	125	2014	2018	-	478097	-
EVOLIS ABS	400	2015	2017	-	512699	-
FLAME	125	-	-	461955	-	-
FLAME	125	-	-	-	493615	-
FLAME X	125	2004	2010	-	493615	-
SKYCRUISER	125	-	-	-	478097	-
SKYCRUISER	125	2006	2013	-	478097	-
SKYCRUISER	125	-	-	-	-	483454
SKYCRUISER	125	-	-	-	-	-
SKYCRUISER	125	-	-	497259	-	-
SKYCRUISER	125	2018	-	-	-	-
SKYCRUISER ABS	125	2011	2013	-	478097	-
SKYLINER	125	-	-	-	450218	-
SKYLINER	125	2003	2009	-	450218	-
SKYLINER	125	2002	2009	-	450218	-
SKYLINER	125	-	-	487729	-	-





COURROIES				OEM
-	-	-	468860	-
-	-	-	-	-
-	-	-	-	-
-	-	-	-	-
-	-	-	-	-
-	-	-	-	-
-	-	-	-	-
-	-	-	468860	-
-	-	-	492216	-
-	-	-	468860	-
-	-	-	-	-
-	-	-	-	-
-	-	-	-	-
-	-	-	-	-
-	-	-	-	-
-	-	-	468860	-
-	-	-	-	-
-	-	-	-	-
-	-	487729	-	-
475647	-	-	-	-
503745	-	-	-	-
-	-	-	-	-
-	-	487726	-	-
-	-	-	-	-
-	-	-	-	-
-	-	-	-	-
-	-	-	-	-
-	-	-	-	-
-	-	-	-	-
-	-	-	-	-
-	-	487726	-	-
-	-	-	-	-
503745	-	-	-	-
-	-	-	-	-
-	-	-	-	-
-	-	-	-	-
-	-	-	-	-

COURROIES

Modèle	Cylindre	Année début	Année fin			
SKYLINER	125	2003	2009	487729	-	-
SKYLINER	125	2002	2009	487729	-	-
TRYPTIK	125	-	-	-	-	-
X-OVER	125	-	-	-	-	-
P.G.O						
G-MAX	125	-	-	-	-	-
PEUGEOT						
CITY STAR EVO	125	2016	2017	478106	-	-
CITY STAR RS	125	2015	2018	478106	-	-
DJANGO	125	2015	2020	490551	-	-
DJANGO	150	2014	2020	490551	-	-
DJANGO ALLURE	125	2015	-	490551	-	-
DJANGO SPORT	150	2014	2017	490551	-	-
ELYSEO	125	-	-	461953	-	-
ELYSEO	125	-	-	496646	-	-
ELYSEO	150	-	-	461953	-	-
LOOXOR	150	-	-	-	-	-
LXR	125	-	-	494757	-	-
METROPOLIS	400	2013	2017	-	-	-
METROPOLIS	400	2014	2020	510626	-	-
METROPOLIS RS	400	2014	2020	510626	-	-
SATELIS	125	-	-	478106	-	-
SATELIS	125	2006	2011	478106	-	-
SATELIS	400	-	-	-	481659	-
SATELIS	500	-	-	-	481659	-
SATELIS ABS	125	2015	2018	478106	-	-
SATELIS COMPRESSOR	125	-	-	496646	-	-
SATELIS EXECUTIVE	125	2015	-	478106	-	-
SATELIS PREMIUM	400	2015	2017	510626	-	-
SATELIS PREMIUM RS	400	2015	2019	510626	-	-
SATELIS RS	125	2015	2016	478106	-	-
SATELIS URBAN	125	2015	2016	478106	-	-
SUM UP	125	-	-	-	-	-
SUM UP	125	-	-	492929	-	-
TWEET	125	-	-	480260	-	-
TWEET	125	2010	2020	480260	-	-
TWEET EVO	125	2015	2018	480260	-	-
TWEET PRO	125	2012	2017	480260	-	-
TWEET RS	125	2010	2020	480260	-	-
VIVACITY	125	2010	2011	496648	-	-
VIVACITY RS	125	2010	2011	496648	-	-
PIAGGIO						
BEVERLY	125	2001	2021	-	489953	-



COURROIES

Modèle	Cylindre	Année début	Année fin			
BEVERLY 4T IE	350	2012	2021	-	512702	-
BEVERLY RST	125	2010	2015	-	489953	-
FLY	125	2004	2013	-	478095	-
FLY	150	-	-	-	-	-
FLY 3V	125	2012	2015	-	478095	-
HEXAGON 4T	125	-	-	-	461958	-
HEXAGON LXT	180	-	-	-	512706	-
LIBERTY	125	-	1998	-	461958	-
LIBERTY	125	-	-	-	-	-
LIBERTY	125	-	-	-	478095	-
LIBERTY	125	2001	-	-	-	-
LIBERTY	125	-	-	-	488407	-
LIBERTY	150	-	-	-	-	-
LIBERTY	150	2002	2021	-	478095	-
LIBERTY I-GET	125	2015	2021	512696	-	-
LX 4T	125	-	-	-	461958	-
MEDLEY	125	2016	2021	512697	-	-
MP3	125	-	-	-	478095	-
MP3	125	-	-	-	-	-
MP3	125	-	-	497257	-	-
MP3	250	-	-	-	494758	-
MP3	300	-	-	-	494758	-
MP3	400	-	-	-	481659	-
MP3	500	-	-	-	481659	-
MP3	500	-	-	-	496634	-
MP3 ABS ASR	350	2018	2020	-	512702	-
MP3 BUSINESS	300	2013	2018	-	494758	-
MP3 HPE ABS ASR	300	2019	2021	512701	-	-
MP3 HPE ABS ASR	500	2018	2021	-	496634	-
MP3 SPORT	300	2013	2018	-	494758	-
MP3 TOURING	300	2011	2012	-	494758	-
MP3 TOURING BUSINESS	500	2011	2020	-	496634	-
MP3 TOURING SPORT	500	2011	2020	-	496634	-
MP3 YOURBAN	300	2011	2021	-	494758	-
SFERA	125	-	-	-	512704	-
SKIPPER	125	-	-	-	461958	-
SKIPPER	125	-	-	-	-	-
SKIPPER	150	-	-	-	-	-
SUPER HEXAGON	125	-	-	-	-	-
SUPER HEXAGON	180	-	-	-	-	-
TYPHOON 2T	125	-	-	-	-	-
X-EVO	125	2007	2016	-	478095	-
X10	125	2012	2015	-	489953	-





COURROIES				OEM
-	-	-	-	-
-	-	-	-	-
-	-	-	-	-
475647	-	-	-	-
-	-	-	-	-
-	-	-	-	-
-	-	-	-	-
475655	-	-	-	-
-	-	-	-	-
-	-	487730	-	-
-	-	-	-	-
475647	-	-	-	-
-	-	-	-	-
-	-	-	-	-
-	-	-	-	-
-	-	-	-	-
-	-	487730	-	-
-	-	-	-	-
-	-	-	-	-
-	-	-	-	-
-	-	-	-	-
-	-	-	-	-
-	-	-	-	-
-	-	-	-	-
-	-	-	-	-
-	-	-	-	-
-	-	-	-	-
-	-	-	-	-
-	-	-	-	-
-	-	-	-	-
-	-	-	-	-
-	-	-	-	-
475647	-	-	-	-
475647	-	-	-	-
475647	-	-	-	-
475647	-	-	-	-
475647	-	-	-	-
-	-	-	-	-
-	-	-	-	-



COURROIES



Modèle	Cylindre	Année début	Année fin			
X10	500	2012	2015	-	496634	-
X10 IE	350	2012	2015	-	512702	-
X7	125	2008	2009	-	-	-
X7	125	-	-	-	478095	-
X7	125	-	-	-	-	-
X7	125	-	-	497257	-	-
X7	250	-	-	-	494758	-
X7	300	-	-	-	494758	-
X7 EVO	125	2010	-	-	-	-
X8	125	-	-	-	-	461357
X8	125	-	-	-	-	-
X8	125	-	-	-	478095	-
X8	125	-	-	-	-	-
X8	125	-	-	497257	-	-
X8	150	-	-	-	-	-
X8	250	-	-	-	494758	-
X9	125	-	-	-	-	461357
X9	125	-	-	-	-	-
X9	125	-	-	-	478095	-
X9	125	-	-	-	-	-
X9	125	-	-	497257	-	-
X9	500	-	-	-	481659	-
XEVO SPORT	125	2007	2016	-	478095	-
ZIP	125	-	-	-	-	-
ZIP	125	-	-	-	478095	-
ZIP	125	-	-	-	-	-
ZIP	125	-	-	497257	-	-
SUZUKI						
AN Z BURGMAN	400	2007	2008	-	496635	-
AN ZA BURGMAN ABS	400	2009	2016	-	496635	-
BURGMAN	125	-	-	-	-	477595
BURGMAN	125	2002	2006	-	478092	-
BURGMAN	125	2007	-	-	478385	-
BURGMAN	125	2007	-	497258	-	-
BURGMAN	400	2006	2009	-	496635	-
UH BURGMAN ABS	125	2009	2020	-	478385	-
UH BURGMAN ABS	125	2009	2020	497258	-	-
SYM						
CITYCOM	300	2007	2015	-	490550	-
FIDDLE	125	-	-	-	-	-
FIDDLE II	125	2010	-	490551	-	-
FIDDLE III	125	2014	2020	490551	-	-
GTS	125	-	-	485368	-	-



COURROIES

Modèle	Cylindre	Année début	Année fin			
GTS	125	-	-	-	-	-
GTS	150	-	-	-	-	-
GTS	200	-	-	-	-	-
GTS	300	-	-	496650	-	-
GTS	300	2009	2021	496650	-	-
HD	125	-	-	494757	-	-
HD 2	125	2010	2021	494757	-	-
JET 14	125	2017	2021	480260	-	-
JET V	125	2011	2011	490551	-	-
JOYMAX EVO	300	2008	2021	496650	-	-
JOYMAX I	300	2017	2021	496650	-	-
JOYMAX SPORT I	300	2017	2021	496650	-	-
JOYRIDE	125	2001	2021	485368	-	-
JOYRIDE	125	-	2005	496653	-	-
SYMPHONY	125	-	-	480260	-	-
SYMPHONY	125	2009	2021	480260	-	-
SYMPHONY S	125	2009	2015	480260	-	-
SYMPHONY ST	125	2009	2015	480260	-	-
SYMPLY	125	-	-	-	-	-
XPRO	125	2013	2015	490551	-	-
VESPA						
ET4	125	-	-	-	512704	-
GTS IE	300	2008	2012	-	494758	-
GTS SUPER	125	2009	2020	-	478095	-
GTS SUPER	300	2008	2021	-	494758	-
GTS TOURING	300	2011	2015	-	494758	-
GTV	300	2009	2021	-	494758	-
LX	125	2013	2017	512696	-	-
LX 2T	125	-	-	-	-	461357
LXV IE 4T	125	2010	2016	-	478095	-
PRIMAVERA	125	2013	2017	512696	-	-
S	125	-	-	-	-	461357
S	125	2007	2020	512696	-	-
S 3V SPORT	125	2012	2020	512696	-	-
SPRINT	125	2014	2021	512696	-	-
YAMAHA						
CYGNUS	125	-	-	461955	-	-
CYGNUS	125	-	-	-	493615	-
MAJESTY	125	-	-	-	450218	-
MAJESTY	125	2003	2009	-	450218	-
MAJESTY	125	-	-	-	-	-
MAJESTY	125	2003	2009	-	-	-
MAJESTY	400	2004	2008	-	496636	-



COURROIES

Modèle	Cylindre	Année début	Année fin			
MAJESTY R	125	2000	2009	-	450218	-
N-MAX	125	2016	-	-	-	-
TRICITY	125	2017	-	-	-	-
TRICITY	125	2015	-	-	-	-
X-CITY	125	2018	-	-	-	-
X-CITY	125	2008	2012	-	478097	-
X-MAX	125	2018	-	-	-	-
X-MAX	125	-	-	-	478097	-
X-MAX	125	2014	2017	-	478097	-
X-MAX	125	2006	2020	-	478097	-
X-MAX	125	-	-	-	-	483454
X-MAX	125	2014	2017	-	-	483454
X-MAX	125	-	-	-	-	-
X-MAX	125	2014	2017	-	-	-
X-MAX	125	-	-	497259	-	-
X-MAX	125	2014	2017	497259	-	-
X-MAX	125	2014	2017	-	-	-
X-MAX	300	2017	-	513053	-	-
X-MAX ABS	125	2011	2020	-	478097	-
X-MAX R	400	2013	2016	-	512699	-
X-MAX R ABS	400	2014	2020	-	512699	-
XP T-MAX	500	2004	-	-	-	483456
XP T-MAX	500	-	-	-	-	-
XP T-MAX	500	2004	2011	-	478192	-
XP T-MAX	500	2004	-	-	-	-
XP T-MAX	500	-	2003	-	496637	-
XP T-MAX	530	2017	-	-	-	506869
XP T-MAX	530	2012	-	-	-	-
XP T-MAX	530	2012	2016	483492	-	-
XP T-MAX	530	-	-	489952	-	-
XP T-MAX	530	2012	2021	489952	-	-
XP T-MAX	560	2017	-	-	-	506869
XP T-MAX BLACK MAX ABS	530	2017	2021	489952	-	-
XP T-MAX DX ABS	530	2017	2018	489952	-	-
XP T-MAX SX ABS	530	2017	2018	489952	-	-

Modèle	Cylindre	Année		
APRILIA				
Sportcity 125 Cube	125	2015		489953
SR125 Max 4T	125	2015	497257	478095
SR125 Max 4T	125	2016		478095
SR125 Max 4T	125	2017		478095
SR125 Motard	125	2015	497257	478095
SR300 i.e. MAX	300	2015		494758
SRV / SVR ATC ABS	850	2015		496640
SRV / SVR ATC ABS	850	2016		496640
SRV / SVR ATC ABS	850	2017		496640
SRV / SVR ATC ABS	850	2018		496640
BMW				
C600 Sport	600	2015		489954
C650 GT	650	2015		489954
C650 GT	650	2016		489954
C650 GT	650	2017		489954
C650 GT	650	2018		489954
C650 GT	650	2019		489954
C650 GT	650	2020		489954
C650 Sport	650	2016		489954
C650 Sport	650	2017		489954
C650 Sport	650	2018		489954
C650 Sport	650	2019		489954
C650 Sport	650	2020		489954
DAELIM				
Besbi 125 SC	125	2015	478100	
Besbi 125 SC	125	2016	478100	
Besbi 125 SC	125	2017	478100	
Besbi 125 SC	125	2018	478100	
Besbi 125 SC	125	2019	478100	
S2 125	125	2015		496633
S3 Touring 125	125	2015	496645	
S3 Touring 125	125	2016	496645	
S3 Touring 125	125	2017	496645	
DERBI				
Boulevard 125	125	2015	497257	478095
GILERA				
Fuoco 500	500	2015		496634
Fuoco 500	500	2016		496634
HONDA				
NSS Forza 125 ADF	125	2015	494755	
NSS Forza 125 ADF	125	2016	494755	
NSS Forza 125 ADF	125	2017	494755	
NSS Forza 125 ADF	125	2018	494755	

Modèle	Cylindre	Année		
NSS Forza 125 ADF	125	2019	494755	
NSS Forza 125 ADF	125	2020	494755	
PCX125	125	2018	512692	
PCX125	125	2019	512692	
PCX125	125	2020	512692	
SH125 i /ABS	125	2015	490549	
SH125 i /ABS	125	2016	490549	
SH125 i /ABS	125	2017	490549	
SH125 i /ABS	125	2018	490549	
SH125 i /ABS	125	2019	490549	
SH125 i /ABS	125	2020	512693	
SH125 Mode	125	2015	512694	
SH125 Mode	125	2016	512694	
SH125 Mode	125	2017	512694	
PCX150	150	2018	512692	
PCX150	150	2019	512692	
PCX150	150	2020	512692	
HUSQVARNA				
TX125 2T	125	2018	478517	
FC 250	250	2018	478517	
KAWASAKI				
J 125	125	2015		489955
J 125	125	2016		489955
J 125	125	2017		489955
J 125	125	2018		489955
J 125	125	2019		489955
J 125	125	2020		489955
300J	300	2015		490550
300J ABS	300	2015		490550
300J ABS	300	2016		490550
300J ABS	300	2017		490550
300J ABS	300	2018		490550
300J ABS	300	2019		490550
300J ABS	300	2020		490550
KYMCO				
Agility 125	125	2015	494756	
Agility 125	125	2015	494756	
Agility 125 16+	125	2016	494756	
Agility 125 16+	125	2017	494756	
Agility 125 16+	125	2018	494756	
Agility 125 16+	125	2019	494756	
Agility 125 16+	125	2020	494756	
Agility 125 4 T Carry	125	2015	494756	
Agility 125 4 T Carry	125	2016	494756	

Modèle	Cylindre	Année		
Agility 125 4 T Carry	125	2017	494756	
Agility 125 4 T Carry	125	2018	494756	
Agility 125 4 T Carry	125	2019	494756	
Agility 125 4 T Carry	125	2020	494756	
Agility 125 4 T Plus	125	2015	494756	
Agility RS 125	125	2015	494756	
Downtown 125 i	125	2016		489955
Downtown 125 i	125	2017		489955
Downtown 125 i	125	2018		489955
Downtown 125 i	125	2019		489955
Downtown 125 i	125	2020		489955
Downtown 125 i / Dinkstreet	125	2015		489955
K-XCT I	125	2015		489955
Like / LX	125	2015	494756	
Movie S 125	125	2015	494756	
People 125 E3	125	2015	494756	
People 125 GTI IE	125	2015		489955
People 125 One I	125	2015	494756	
People 125 S/S DD	125	2015	494756	
X-Town 125	125	2016		489955
X-Town 125	125	2017		489955
X-Town 125	125	2018		489955
X-Town 125	125	2019		489955
Agility	150	2015	494756	
Downtown 300 i	300	2015		490550
Downtown 300 i ABS	300	2015		490550
Downtown 300 i ABS	300	2016		490550
K-XCT I	300	2015		490550
K-XCT I	300	2016		490550
K-XCT I	300	2017		490550
People 300 GTI IE / ABS	300	2015		490550
Downtown I ABS	350	2015		490550
Downtown I ABS	350	2016		490550
Downtown I ABS	350	2017		490550
Downtown I ABS	350	2018		490550
Downtown I ABS	350	2019		490550
Downtown I ABS	350	2020		490550
Xciting 400 I	400	2015		496642
Xciting 400 I	400	2016		496642
Xciting 400 I	400	2017		496642
Xciting S 400 I	400	2018		496642
Xciting S 400 I	400	2019		496642
AK 550	550	2017	512695	
AK 550	550	2018	512695	
AK 550	550	2019	512695	

Modèle	Cylindre	Année		
AK 550	550	2020	512695	
MyRoad 700 i	700	2015		496644
MBK				
Evolis 125	125	2015	497259	478097
Evolis 125 ABS	125	2015	497259	478097
Skycruiser 125	125	2015	497259	478097
Skycruiser 125 ABS	125	2015	497259	478097
XCI25 Flame X	125	2015		493615
Evolis 400 ABS	400	2015		512699
Evolis 400 ABS	400	2016		512699
Evolis 400 ABS	400	2017		512699
PEUGEOT				
City Star Evo	125	2016	478106	
City Star Evo	125	2017	478106	
City Star IE 4T	125	2015	478106	
City Star RS	125	2015	478106	
City Star RS	125	2016	478106	
City Star RS	125	2017	478106	
City Star RS	125	2018	478106	
Django 125	125	2015	490551	
Django 125	125	2016	490551	
Django 125	125	2017	490551	
Django 125	125	2018	490551	
Django 125	125	2019	490551	
Django 125	125	2020	490551	
Django Allure	125	2015	490551	
Satelis 125 (ABS)	125	2015	478106	
Satelis 125 (ABS)	125	2016	478106	
Satelis 125 (ABS)	125	2016	478106	
Satelis 125 (ABS)	125	2017	478106	
Satelis 125 (ABS)	125	2018	478106	
Satelis 125 RS Premium	125	2015	478106	
Satelis 125 RS Premium	125	2016	478106	
Satelis 125 RS Urban	125	2015	478106	
Satelis 125 RS Urban	125	2016	478106	
Satelis 125 SRX	125	2015	478106	
Satelis 125 Urban (ABS)	125	2015	478106	
Satelis 125i Executive (ABS)	125	2015	478106	
Satelis 125i Premium	125	2015	478106	
Satelis 125i Urban (ABS)	125	2015	478106	
Tweet 125	125	2015	480260	
Tweet 125	125	2016	480260	
Tweet 125	125	2017	480260	
Tweet 125	125	2018	480260	

MOTEUR

CYCLE

PNEUMATIQUE

ATELIER



ACCESSOIRES



ÉLECTRICITÉ

FILTRATION



FREINAGE



TRANSMISSION

Modèle	Cylindre	Année		
Tweet 125	125	2019	480260	
Tweet 125	125	2020	480260	
Tweet 125 Evo	125	2015	480260	
Tweet 125 Evo	125	2016	480260	
Tweet 125 Evo	125	2017	480260	
Tweet 125 Evo	125	2018	480260	
Tweet 125 Pro	125	2015	480260	
Tweet 125 Pro	125	2016	480260	
Tweet 125 RS	125	2015	480260	
Tweet 125 RS	125	2016	480260	
VivaCity 125	125	2015	496648	
VivaCity 125	125	2016	496648	
VivaCity 125 RS	125	2015	496648	
Django 150	150	2015	490551	
Django 150 Sport	150	2015	490551	
Tweet EVO 4T	150	2015	480260	
Metropolis (3 roues)	400	2015	510626	
Metropolis (3 roues)	400	2016	510626	
Metropolis (3 roues)	400	2017	510626	
Metropolis (3 roues)	400	2018	510626	
Metropolis (3 roues)	400	2019	510626	
Metropolis (3 roues)	400	2020	510626	
Metropolis RS (3 roues)	400	2015	510626	
Metropolis RS (3 roues)	400	2016	510626	
Metropolis RS (3 roues)	400	2017	510626	
Metropolis RS (3 roues)	400	2018	510626	
Metropolis RS (3 roues)	400	2019	510626	
Metropolis RS (3 roues)	400	2020	510626	
Satelis 400 II RS Premium	400	2015	510626	
Satelis 400 II RS Premium	400	2016	510626	
Satelis 400 II RS Premium	400	2017	510626	
Satelis 400 II RS Premium	400	2018	510626	
Satelis 400 II RS Premium	400	2019	510626	
Satelis II 400 Premium	400	2015	510626	
Satelis II 400 Premium	400	2016	510626	
Satelis II 400 Premium	400	2017	510626	
PIAGGIO / VESPA				
Beverly 125 i.e	125	2015		489953
Beverly 125 i.e	125	2016		489953
Beverly 125 i.e	125	2017		489953
Beverly 125 i.e	125	2018		489953
Beverly 125 RST E3 4T	125	2015		489953
Fly 125 i.e	125	2015	497257	478095
Fly 125 i.e 3V	125	2016	497257	478095

Modèle	Cylindre	Année		
Fly 125 i.e 3V	125	2017	497257	478095
Liberty 125 IGET	125	2015	512696	
Liberty 125 IGET	125	2016	512696	
Liberty 125 IGET	125	2017	512696	
Liberty 125 IGET	125	2018	512696	
Liberty 125 IGET	125	2019	512696	
Liberty 125 IGET	125	2020	512696	
LX125	125	2015	512696	
LXV125 i.e	125	2015	497257	478095
Medley 125	125	2016	512697	
Medley 125	125	2017	512697	
Medley 125	125	2018	512697	
Medley 125	125	2019	512697	
Medley 125	125	2020	512697	
New Liberty 125 I-Get	125	2016	512696	
New Liberty 125 I-Get	125	2017	512696	
S125	125	2015	512696	
S125 Sport i.e	125	2015	512696	
Vespa 125 Primavera/ ABS	125	2015	512696	
Vespa 946 IV 3V ABS	125	2015	512696	
Vespa GTS IE Super 4V	125	2015	497257	478095
Vespa GTS IE Super Sport 4V	125	2015	497257	478095
Vespa GTS IE Super Sport ABS IGET	125	2016	512697	
Vespa GTS IE Super Sport ABS IGET	125	2017	512697	
Vespa GTS IE Super Sport ABS IGET	125	2018	512697	
Vespa GTS IE Super Sport ABS IGET	125	2019	512697	
Vespa GTS IE Super Sport ABS IGET	125	2020	512697	
Vespa Sprint 4T 3V/ABS	125	2015	512696	
Vespa Sprint S 4T 3V/ABS	125	2015	512696	
X10 125 IE / ABS	125	2015		489953
X10 125 IE Sport / ABS	125	2015		489953
X10 125 IE Sport ABS	125	2016		489953
X10 125 IE Sport ABS	125	2017		489953
XEvo 125	125	2015	497257	478095
XEvo 125 Sport	125	2015	497257	478095
XEvo 125 Sport	125	2016	497257	478095
XEvo 125 Sport	125	2017	497257	478095
Liberty 150	150	2015	497257	478095
GTV300 IE Vespa	300	2015		494758
MP3 300 HPE ABS ASR	300	2019	512701	
MP3 300 HPE ABS ASR	300	2020	512701	
MP3 300 i.e / LT Business ABS	300	2015		494758
MP3 300 i.e LT Business ABS	300	2016		494758
MP3 300 i.e LT Business ABS	300	2017		494758
MP3 300 i.e./LT Touring / Sport	300	2015		494758

Modèle	Cylindre	Année		
MP3 300 i.e. /LT Touring / Sport ABS	300	2015		494758
MP3 300 i.e. LT Touring Sport ABS	300	2016		494758
MP3 300 i.e. LT Touring Sport ABS	300	2017		494758
MP3 300 i.e. Yourban ERL / Sport	300	2015		494758
MP3 300 i.e. Yourban ERL / Sport	300	2016		494758
MP3 300 i.e. Yourban ERL / Sport	300	2017		494758
MP3 300 i.e. Yourban ERL / Sport	300	2018		494758
MP3 300 i.e. Yourban ERL / Sport	300	2019		494758
MP3 300 i.e. Yourban ERL / Sport	300	2020		494758
MP3 300 i.e. Yourban ERL Sport	300	2016		494758
MP3 300 i.e. Yourban ERL Sport	300	2017		494758
Vespa GTS300 IE	300	2015		494758
Vespa GTS300 IE ABS	300	2015		494758
Vespa GTS300 IE Touring	300	2015		494758
Vespa GTS300 IE Touring ABS	300	2015		494758
Vespa GTS300 IE Touring ABS	300	2016		494758
Vespa GTS300 IE Touring ABS	300	2017		494758
Vespa GTS300 IE Touring ABS	300	2018		494758
Vespa GTS300 IE Touring ABS HPE	300	2019		494758
Vespa GTS300 Super	300	2015		494758
Vespa GTS300 Super	300	2016		494758
Vespa GTS300 Super	300	2017		494758
Vespa GTS300 Super	300	2018		494758
Vespa GTS300 Super HPE	300	2019		494758
Vespa GTS300 Super Sport	300	2015		494758
Vespa GTS300 Super Sport ABS	300	2015		494758
Beverly IE 4T	350	2015		512702
Beverly IE 4T ABS	350	2015		512702
Beverly IE 4T ABS	350	2016		512702
Beverly IE 4T ABS	350	2017		512702
Beverly IE 4T ABS	350	2018		512702
Beverly IE 4T ABS	350	2019		512702
Beverly IE 4T ABS	350	2020		512702
MP3 350 ABS ASR	350	2018		512702
MP3 350 ABS ASR	350	2019		512702
MP3 350 ABS ASR	350	2020		512702
X10 IE 4T	350	2015		512702
X10 IE 4T Executive ABS	350	2015		512702
MP3 500 HPE ABS ASR	500	2018		496634
MP3 500 HPE ABS ASR	500	2019		496634
MP3 500 HPE ABS ASR	500	2020		496634
MP3 500 i.e. Business/Sport ABS	500	2015		496634
MP3 500 i.e. Business/Sport ABS	500	2016		496634
MP3 500 i.e. Business/Sport ABS	500	2017		496634
MP3 500 i.e. Business/Sport ABS	500	2018		496634

Modèle	Cylindre	Année		
X10 500 Executive ABS	500	2015		496634
X10 500 i.e.e Executive ABS	500	2015		496634
X10 500 i.e.e Executive ABS	500	2016		496634
X10 500 i.e.e Executive ABS	500	2017		496634
SUZUKI				
UH125 Burgman ABS	125	2015	497258	478385
UH125 Burgman ABS	125	2016	497258	478385
UH125 Burgman ABS	125	2017	497258	478385
UH125 Burgman ABS	125	2018	497258	478385
UH125 Burgman ABS	125	2019	497258	478385
UH125 Burgman ABS	125	2020	497258	478385
AN400 /Z Burgman	400	2015		496635
AN400 /Z Burgman ABS	400	2015		496635
AN400 Z Burgman ABS	400	2016		496635
AN400 Z Burgman ABS	400	2017		496635
SYM/SANYANG				
Fiddle III 125	125	2015	490551	
Fiddle III 125	125	2016	490551	
Fiddle III 125	125	2017	490551	
Fiddle III 125	125	2018	490551	
Fiddle III 125	125	2019	490551	
Fiddle III 125	125	2020	490551	
HD125 2 IE	125	2015	494757	
Jet 14 AC	125	2017	480260	
Jet 14 AC	125	2018	480260	
Jet 14 AC	125	2019	480260	
Jet 14 AC	125	2020	480260	
Jet 14 LC	125	2017	480260	
Jet 14 LC	125	2018	480260	
Jet 14 LC	125	2019	480260	
Jet 14 LC	125	2020	480260	
Jet 5 4T	125	2015	490551	
Joyride 125	125	2015	485368	
Symphony 125	125	2015	480260	
Symphony 125	125	2016	480260	
Symphony 125	125	2017	480260	
Symphony 125	125	2018	480260	
Symphony S 125 LC	125	2018	480260	
Symphony S 125 LC	125	2019	480260	
Symphony ST 125	125	2015	480260	
Symphony ST 125	125	2016	480260	
X Pro 4T	125	2015	490551	
X Pro 4T	125	2016	490551	
X Pro 4T	125	2017	490551	

Modèle	Cylindre	Année		
X Pro 4T	125	2018	490551	
X Pro 4T	125	2019	490551	
X Pro 4T	125	2020	490551	
Citycom 300	300	2015		490550
Citycom 300	300	2016		490550
Cruisym 300	300	2017	496650	
Cruisym 300	300	2018	496650	
Cruisym 300	300	2019	496650	
Cruisym 300	300	2020	496650	
GTS300	300	2015	496650	
GTS300	300	2016	496650	
GTS300	300	2017	496650	
GTS300	300	2018	496650	
Joy Max Evo	300	2015	496650	
Joy Max I	300	2015	496650	
Joy Max I ABS	300	2015	496650	
Joy Max Sport	300	2016	496650	
Joymax Z	300	2019	496650	
Joymax Z	300	2020	496650	
YAMAHA				
X-City 125	125	2015	497259	478097
YP125 R Majesty	125	2015		450218
YP125 X-Max	125	2015	497259	478097
YP125 X-Max ABS	125	2015	497259	478097
YP125 X-Max ABS	125	2016	497259	478097
YP125 X-Max ABS	125	2017	497259	478097
YP125 X-Max ABS	125	2018	497259	478097
YP125 X-Max ABS	125	2019	497259	478097
YP125 X-Max ABS	125	2020	497259	478097
YPR400 X-Max	400	2015		512699
YPR400 X-Max ABS	400	2015		512699
YPR400 X-Max ABS	400	2016		512699
YPR400 X-Max ABS	400	2017		512699
YPR400 X-Max ABS	400	2018		512699
YPR400 X-Max ABS	400	2019		512699
YPR400 X-Max ABS	400	2020		512699
XP530 T-MAX	530	2017	489952	527383
XP530 T-MAX / BLACK MAX	530	2015	489952	527383
XP530 T-MAX / BLACK MAX	530	2016	489952	527383
XP530 T-MAX / DX / SX	530	2017	489952	527383
XP530 T-MAX / DX / SX	530	2018	489952	527383
XP530 T-MAX / DX / SX	530	2019	489952	527383



503764



503755



503754



503765



503768



503756



503761



503758



503753



503763



503752



503762



503767



503766



503757



/ KIT ENTRETIEN / REVISION MAXI SCOOTER OEM PIAGGIO

Modèle	Réf.
125 LIBERTY LA POSTE (1R000398)	503761
125 MP3 2006->2008 (1R000384)	503758
125 X9 EVOLUTION (1R000408)	503766
125 XEVO EURO3 2007->2016	503757
300 MP3 (1R000403)	503764
300 MP3 IE 2010->2014 (1R000378)	503755
300 MP3 YOURBAN/BUSINESS 11->18 (1R000377)	503754
300 VESPA GTV/GTS 2009-> (1R000404)	503765
350 MP3 MAXI SPORT ABS 2018-> (1R000371)	503768
400 MP3 IE 2007->2011 (1R000379)	503756
500 MP3 LT SPORT 2007->2013 (1R000376)	503753
500 MP3 LT SPORT 2007->2013 (1R000402)	503763
500 MP3 LT SPORT 2014->2018 (1R000375)	503752
500 MP3 LT SPORT 2014->2018 (1R000401)	503762
500 MP3 LT SPORT BUSINEE 2015->2018	503767



494195



494292



525977



525979

/ KIT ENTRETIEN/REVISION MAXI SCOOTER OEM PEUGEOT

Modèle	Réf.
SATELIS/GEOPOLIS 500 (10 ET 20K KMS)	484422
GEOPOLIS 125 (10 ET 20K KMS)	488036
METRO €2-4-5/SAT2 €4 400 INJ LC (ENT700)	494195
SATELIS/GEOPOLIS 400 (10 ET 20K KMS)	494255
SATELIS 125 M2 2006->2007	494273
SATELIS 125 COMPRESSEUR 2007	494291
CITY125/SAT/ SAT 2 4T LIQUIDE INJ M3A €3	494292
TWEET 125/150 CARBU - ENT600	494460

Modèle	Réf.
GEOPOLIS 250 (10000KMS)	496925
DJANGO 125/150 (AC) - ENT650	500871
VIVACITY 3 125	501015
TWEET 125 €4 - ENT600Y	520567
CITY LCFY 125 LIQUIDE INJ M3A 4T €4(ENT640)	525389
CITY/SAT/SAT 2 125 M3A €3 POULIE HZ	525977
METRO 400 €2-4-5/SAT2 400 (ENT700M)	525979
PULSION/SAT2 (ENT740YM)	529635



506090



506094



506095



506089



512743



506096



506091



506092



506093



512742



512741

/ KIT ENTRETIEN / REVISION MAXI SCOOTER TOP PERF

Modèle	Réf.
KYMC0 125 AGILITY R16 2008->2012	506090
SUZUKI 125 BURGMAN 2007->2013	506094
SUZUKI 125 BURGMAN 2014->	506095
PIAGGIO 125 MP3 2008->2011/VESPA GTS EURO 3	506089
HONDA 125 PCX 2015->2018	512743
HONDA 125 SH 2001->2012	506096

Modèle	Réf.
YAMAHA 125 XMAX 2006->2016	506091
YAMAHA 125 XMAX 2017->	506092
YAMAHA 500 TMAX 2001->2007	506093
YAMAHA 530 TMAX 2012->2016	512742
PIAGGIO 500 MP3 LT 2011->2013	512741



Modèle	Cylindre	Année début	Année fin	Pignon	Couronne	Chaîne	Référence
APRILIA							
125 RS	125	1999	2005	17	40	A520 106L	532598
RS 125	125	1999	2005	17	40	A520 106	526943
750 SHIVER	750	2009	2010	16	44	A525 108L	532618
RSV 1000 R/SP	1000	1998	2003	17	42	A525 108L	532626
RSV4 1000 APRC	1000	2012	2013	16	42	A525 110L	532715
1000 TUONO RACING	1000	2006	2010	16	40	A525 106L	532678
TUONO 1000 V4 APRC	1000	2011	2013	16	42	A525 110L	532679
BMW							
F 800 R	800	2005	2014	20	47	A525 120L	532510
S 1000 XR	1000	2015	2019	17	45	A525 128L	532522
S 1000 R	1000	2013	2020	17	-45	A525 120L	532525
F 800 GS BOLTS 10.5MM	800	2013	2018	16	42	A525 116L	532547
F 650 GS / DAKAR	650	1999	2007	16	47	A520 112L	532551
F 650 STRADA / FUN	650	1997	2003	16	47	A520 110L	532680
BRIXTON							
BX 125 Cromwell	125	2018	2021	14	47	A428 122	505741
BX 125	125	2018	2021	14	47	A428 122L	505741
CAGIVA							
125 W8	125	1996	1996	13	46	A520 110	526944
DAELIM							
125 VL DAYSTAR	125	2001	2007	14	42	A428 146L	532531
125 ROADSPORT	125	2008	2016	14	45	A428 130L	526946
125 DAYSTAR II	125	2008	2012	15	45	A428 148L	526945
125 VT	125	1999	2003	14	42	A428 134L	532647
125 ROADWIN	125	2007	2013	14	45	A428 130L	532684
125 ROADWIN	125	2004	2006	14	42	A428 130L	532703
VL 125 Fi Daystar II	125	2008	2012	15	45	A428 148	526945
VJF 125 Fi Roadsport	125	2008	2016	14	45	A428 130	526946
VJ 125 Roadwin	125	2004	2006	14	42	A428 130	526947
VJ 125 Roadwin	125	2007	2013	14	45	A428 130	526948
VL 125 Daystar	125	2001	2007	14	42	A428 146	526949
VT 125	125	1999	2003	14	42	A428 134	526950
DERBI							
125 Terra Adventure	125	2007	2014	14	51	A428 130	526951
DRD 125 SM Senda	125	2009	2014	14	50	A428 132	526952
125 TERRA	125	2007	2014	14	51	A428 130L	532599
SENDA 125 DRD SM	125	2009	2013	14	50	A428 132L	532672
DUCATI							
600 MONSTER	600	1999	2001	15	46	A520 102L	532734
696 MONSTER	696	2009	2012	15	45	A520 108L	532641
796 MONSTER	796	2010	2013	15	39	A525 104L	532545
800 SCRAMBLER	800	2017	2020	15	46	A520 104L	532735
800 MONSTER S2 R	800	2005	2007	15	41	A520 104L	532700



Modèle	Cylindre	Année début	Année fin	Pignon	Couronne	Chaîne	Référence
992 ST3	992	2004	2007	15	42	A525 102L	532650
MTS 1200	1200	2010	2014	15	40	A530 108L	532520
FANTIC							
125 CABALLERO SCRAMBLER	125	2018	2020	14	58	A428 138	526953
CAB 125 SCRAMBLER	125	2018	2020	14	58	A428 138L	532736
FB MONDIAL							
HPS 125 HIPSTER	125	2017	2020	13	62	A428 142	526954
125 HIPSTER	125	2017	2020	13	62	A428 142L	532652
HM-HONDA							
CRM F 125	125	2011	2016	14	58	A428 140	526955
CRM 125 F 4T	125	2011	2016	14	58	A428 140L	526955
HONDA							
CBR 125 R 4,5,6	125	2004	2006	15	42	A428 124	482978
NX 125 K,L,M,N,P,R,S,T,V	125	1989	1997	16	50	A428 128	526956
CBF 125 M 9,A,B,C,D,E,F,G	125	2009	2016	16	42	A428 118	526957
CB 125 F F,G,H,J,K,L	125	2015	2020	15	45	A428 122	526958
CA 125 Rebel S,T,V,W,X,Y	125	1995	2000	13	39	A520 112	526959
CB 125 K1-K5,K1-K5,K1-K5,K1-K5	125	1972	1976	15	47	A428 118	526960
CB 125 R J,K,L	125	2018	2020	15	47	A428 134	526961
CB 125 T	125	1977	1978	15	39	A428 112	526962
CB 125 TD C,D,E,F,G,H,J	125	1982	1988	15	40	A428 120	526963
CBR 125 R C,D,E,F,G	125	2012	2016	15	44	A428 128	526964
CG 125 K1,K1,K1,A,B,C,D,E	125	1977	1984	14	34	A428 100	526965
CLR 125 W X,Y,1,2,3	125	1999	2003	17	50	A428 128	526966
CM 125 C C,D,E,F	125	1982	1985	15	43	A428 120	526967
CRM 125 R L,M,N,P,R	125	1990	1994	14	40	A520 108	526968
CRM 125 R S,T,V,W,X	125	1995	1999	14	38	A520 108	526969
MSX 125 A Grom ABS H,J,K,L	125	2017	2020	15	34	A420 106	526970
MTX 125 RW D,E,F,G	125	1983	1986	15	53	A428 130	526971
MTX 125 R G,H,J,K,L,M,N,P,R,S	125	1986	1995	13	40	A520 106	526972
NSR 125 R P,R,S,T,V,W,X	125	1993	1999	14	36	A520 108	526973
VT 125 C Shadow X,Y,1,2,3,4,5,6,7,8	125	1999	2008	14	41	A520 112	526974
XL 125 K2,K3	125	1978	1979	15	43	A428 114	526975
XL 125 R C,D,E,F,G,H,J,K,L,M,N,P,R,S,T,V	125	1982	1997	15	53	A428 128	526976
XL 125 S Z,A,B,C	125	1979	1982	14	47	A428 118	526977
XL 125 V Varadero Y,1,2,3,4,5,6,7,8,9,A,B,C,D,E,F,G	125	2000	2016	14	44	A520 110	526978
XLR 125 R V,W,X,Y,1	125	1997	2001	17	51	A428 132	526979
XR 125 L 3,4,5,6,7,8	125	2003	2008	17	54	A428 132	526980
XL 125 V VARADERO	125	2000	2016	14	44	A520 110L	482981
CM 125 C	125	1982	1985	15	43	A428 120L	532463
VT 125 C SHADOW	125	1999	2008	14	41	A520 112L	532470
CBR 125	125	2004	2006	15	42	A428 124L	482978
125 CBF	125	2009	2016	16	42	A428 118L	532480
XL 125 S/ XR	125	1979	1982	14	47	A428 118L	532485



Modèle	Cylindre	Année début	Année fin	Pignon	Couronne	Chaîne	Référence
CRM 125 R V,W,X	125	1995	1999	14	38	A520 108L	532490
125 CBF	125	2015	2020	15	45	A428 122L	532502
MSX 125	125	2017	2020	15	34	A420 106L	532511
XL 125 R	125	1982	1997	15	53	A428 128L	532517
CBR 125 R	125	2012	2016	15	44	A428 128L	482979
XR 125 L	125	2003	2008	17	54	A428 132L	532534
MTX 125 R RALLY	125	1986	1995	13	40	A520 106L	532573
HON NX 125 TRANSCITY	125	1989	1997	16	50	A428 128L	532575
CB 125 K5/JX	125	1972	1976	15	47	A428 118L	532586
NSR 125 R	125	1993	1999	14	36	A520 108L	532600
CRM 125	125	1990	1994	14	40	A520 108L	532621
XL 125 K2-K3	125	1978	1979	15	43	A428 114L	532628
XLR 125 R	125	1997	2001	17	51	A428 132L	532642
CG 125	125	1977	1984	14	34	A428 100L	532674
MTX 125 R	125	1983	1986	15	53	A428 130L	532681
CLR 125 CITY FLY	125	1999	2003	17	50	A428 128L	532691
CB 125 T2	125	1977	1978	15	39	A428 112L	532717
CB 125 R	125	2018	2020	15	47	A428 134L	532718
CB 125 TD	125	1982	1988	15	40	A428 120L	532739
CB 500	500	1994	2003	15	40	A525 108L	532464
CB 500 F	500	2013	2016	15	41	A520 112L	532472
CB 500 X	500	2013	2015	15	41	A520 112L	532503
CBR 500 R	500	2013	2017	15	41	A520 112L	532566
CBF 500	500	2004	2007	15	41	A525 116L	532629
CB 600 F HORNET	600	1998	2006	15	42	A525 110L	532459
CB 600 F HORNET	600	2007	2010	16	43	A525 118L	532466
XL 600 V	600	1989	2000	15	47	A525 118L	532475
CBF 600 S	600	2004	2007	15	43	A525 116L	532487
CBR 600 RR	600	2003	2006	16	42	A525 112L	532518
CBR 600 RR	600	2009	2019	16	41	A525 112L	532542
CBR 600 F	600	1991	1996	15	43	A530 108L	532579
VT 600 C SHADOW	600	1987	2000	16	44	A525 120L	532587
CB 600 F HORNET	600	1998	2006	15	42	A525 110L	532613
XL 600 V	600	1987	1988	15	47	A525 118L	532648
CBF 600 N/S	600	2008	2013	16	42	A525 124L	532653
CBF 600 NA ABS	600	2008	2012	16	42	A525 124L	532663
CB 600 F HORNET #520	600	1998	2006	15	42	A520 110L	532665
RACCBR 600 RR	600	2009	2019	16	41	A520 112L	532666
XL 600 LM	600	1985	1987	15	40	A5203 106L	532692
XL 650 V TRANSALP	650	2000	2007	15	48	A525 118L	532580
CB 650 F ABS	650	2015	2016	15	42	A525 118L	532630
NX 650	650	1991	1995	15	47	A520 110L	532664
CB 6	650	2014	2014	15	42	A525 118L	532685
NX 650	650	1996	2002	15	46	A520 110L	532693



Modèle	Cylindre	Année début	Année fin	Pignon	Couronne	Chaîne	Référence
SLR 650	650	1997	1998	14	43	A520 108L	532719
XRV 650 AFRICA TWIN	650	1988	1989	16	49	A525 124L	532740
XLV 700 TRANSALP	700	2008	2013	15	47	A525 118L	532567
NC 700 S	700	2012	2013	16	43	A520 114L	532590
NC 700 INTEGRA DTC	700	2012	2013	16	39	A520 112L	532622
NC 700 XA ABS	700	2014	2014	16	43	A520 114L	532694
XRV 750 AFRICA TWIN	750	1993	2000	16	45	A525 124L	532495
VFR 750 F	750	1990	1997	16	43	A530 112L	532496
NC 750 INTEGRA DCT	750	2014	2017	17	39	A520 112L	532512
XRV 750 AFRICA TWIN	750	1990	1992	16	46	A525 124L	532601
CB 750 F2 SEVEN FIFTY	750	1995	2001	15	40	A525 112L	532606
ADV 750 X	750	2017	2023	17	38	A520 118L	532607
NC 750 X	750	2014	2015	17	43	A520 114L	532610
NC 750 S INTEGRA DCT	750	2018	2020	17	39	A520 112L	532643
VF 750 C	750	1993	1995	16	40	A530 120L	532720
VT 750 C2	750	1997	2000	17	41	A525 122L	532741
VFR 800 V-TEC	800	2002	2005	16	43	A530 110L	532507
VFR 800 F	800	1998	2005	17	43	A530 108L	532526
CBR 900/929/954 RR	900	2000	2003	16	42	A530 108L	532527
CB 900 HORNET	900	2002	2007	16	43	A530 114L	532552
CBR 900 RR	900	1992	1995	16	42	A530 108L	532611
CBR 900 RR	900	1999	1999	16	42	A525 108L	532721
CB 1000 R	1000	2009	2015	16	44	A530 116L	532484
XL 1000 V VARADERO	1000	1999	2011	16	47	A525 112L	532500
CBF 1000	1000	2006	2012	16	43	A530 120L	532556
CBF 1000 F	1000	2010	2015	16	41	A530 120L	532612
VTR 1000 FIRESTORM	1000	1997	2006	16	41	A530 102L	532623
CBR 1000 R	1000	2009	2016	16	42	A530 116L	532624
CBR 1000 R #520 RACING	1000	2009	2016	16	42	A520 116L	532631
CBR 1000 R #525 END	1000	2009	2016	16	42	A525 116L	532654
CBR 1000 RR F-BLADE	1000	2004	2005	16	40	A530 114L	532686
CBR 1000 F	1000	1989	1992	17	42	A530 114L	532704
CBR 1000 RR	1000	2006	2007	16	42	A530 114L	514538
CRF 1000	1000	2018	2019	16	42	A525 124L	532742
CBR 1100 XX	1100	1997	2008	17	44	A530 110L	532568
CB 1300	1300	2003	2009	18	39	A530 114L	532581
HYOSUNG							
GT 125 R	125	2006	2015	14	52	A428 136	526981
GV 125 Aquila	125	2001	2010	13	48	A428 138	526982
GT 125 Comet	125	2003	2010	14	52	A428 136	526983
GT 125 COMET	125	2003	2010	14	52	A428 136L	532530
125 GV AQUILA	125	2001	2010	13	48	A428 138L	532559
125 COMET	125	2006	2015	14	52	A428 136L	532584



Modèle	Cylindre	Année début	Année fin	Pignon	Couronne	Chaîne	Référence
KAWASAKI							
BN 125 Eliminator A1,A2,A3,A4,A5,A6	125	1998	2003	15	46	A428 132	526984
NINJA 300	300	2013	2016	14	42	A5203 106L	532733
ER 500	500	1997	2007	17	42	A520 106L	532671
GPZ 500 S	500	1994	2004	16	41	A520 104L	532699
ZX-6R/ZX 636	600	1998	2001	15	40	A525 108L	525278
ZZR 600 E1-E12	600	1993	2007	16	48	A530 112L	532616
RACING ZX-6R	600	2007	2016	16	43	A520 112L	532617
ZX-6R	600	2007	2016	16	43	A520 112L	532638
ER 6 N	650	2006	2016	15	46	A520 114L	532471
VERSYS 650	650	2007	2023	15	46	A520 114L	532539
ER 6 F	650	2005	2016	15	46	A520 114L	532544
Z 650	650	2017	2023	15	46	A520 114L	532558
Z 750	750	2004	2013	15	43	A520 112L	532468
ZR-7	750	1999	2004	16	38	A525 108L	532499
ZR 7 S (ZR 750 S)	750	2001	2005	16	38	A525 108L	532564
Z 750 S	750	2005	2007	15	43	A520 112L	532597
Z 800 E	800	2013	2016	15	45	A520 114L	532583
Z 800	800	2013	2016	15	45	A520 114L	532605
ZX-9R	900	1998	2001	16	41	A530 110L	532714
Z 900	948	2017	2023	15	44	A525 114L	532659
ZX 10 R	1000	2004	2005	17	39	A525 110L	532532
ZX 10 R	1000	2008	2010	17	41	A525 110L	532537
Z 1000	1000	2003	2006	16	42	A525 112L	532565
Z 1000	1000	2007	2009	15	40	A525 110L	532639
Z 1000	1000	2010	2013	15	42	A525 112L	532640
ZZR 1400 ABS	1400	2020	2020	17	42	A530 118L	532677
KTM							
125 Duke	125	2011	2012	14	45	A520 112	526985
125 Duke	125	2022	2022	14	45	A520 112	526986
RC 125	125	2014	2022	14	45	A520 112	526987
125 DUKE 4T	125	2022	2023	14	45	A520 112L	532479
125 DUKE 4T	125	2011	2012	14	45	A520 112L	532505
125 RC	125	2014	2023	14	45	A520 112L	532660
390 DUKE	390	2022	2023	15	45	A5203 112L	532524
690 SMC	690	2008	2011	16	42	A520 116L	532619
690 DUKE	690	2008	2012	16	40	A520 114L	532661
790 DUKE	790	2018	2023	16	41	A520 116L	532737
990 SUPER DUKE	990	2007	2013	16	38	A525 110L	532540
990 SMT	990	2009	2010	17	41	A525 112L	532651
990 ADVENTURE	990	2006	2012	16	42	A525 118L	532701
990 SMR	990	2008	2012	17	41	A525 112L	532702
1190 ADVENTURE-R	1190	2013	2016	17	42	A525 118L	532627
1290 SUPERDUKE	1290	2016	2022	17	38	A525 112L	532519



Modèle	Cylindre	Année début	Année fin	Pignon	Couronne	Chaîne	Référence
1290 ADVENTURE	1290	2015	2017	17	42	A525 118L	532716
KYMCO							
CK1 125	125	2014	2016	15	38	A428 122	526988
KR 125 Quannon Sport	125	2007	2013	15	42	A428 130	526989
125 Zing Custom Style	125	1997	2006	16	41	A428 124	526990
125 ZING	125	1997	2006	16	41	A428 124L	532645
125 QUANNON	125	2007	2013	15	42	A428 130L	532646
125 CK1	125	2014	2016	15	38	A428 122L	532662
125 KPW / K-PIPE	125	2012	2021	14	36	A428 110L	527594
MASH							
125 Seventy	125	2014	2016	13	42	A428 118	505739
125 CaféRacer	125	2017	2017	13	42	A428 118	505740
ORCAL							
ASTOR 125	125	2017	2019	14	45	A428 120	526991
SKYTEAM							
125 Skymax	125	2010	2015	15	32	A420 86	505738
SUZUKI							
RV 125 Van-Van K2,K3,K4,K5,K6	125	2002	2006	15	51	A428 134	526992
DR 125 SM K8,K9,L0,L1,L2,L3	125	2008	2013	16	50	A428 130	526993
GN 125 Z,D,R,S,T	125	1982	1996	14	41	A428 114	526994
GN 125 V,W,X,Y,K1	125	1997	2001	14	41	A428 114	526995
GT 125	125	1974	1981	14	47	A428 124	526996
GZ 125 Marauder W,X,Y,K1,K2,K3,K4,K5,K6,K7,K8,K9,L0,L1	125	1998	2011	15	45	A428 132	526997
RV 125 Van-Van K7,K8,K9,L0,L1,L2,L3,L4,L5,L6,L7	125	2007	2017	14	49	A428 134	526998
TS 125 A,B,C,CZ	125	1975	1978	14	50	A428 118	526999
TS 125 ER,N,T,X,Z	125	1979	1982	15	44	A428 114	527000
VL 125 Intruder X,Y,K1,K2,K3,K4,K5,K6,K7,K8	125	1999	2008	14	56	A428 142	527001
GSX-R 600	600	2004	2005	16	45	A525 112L	532682
SV 650 ABS	650	2022	2023	15	46	A520 112L	532658
GSX 600 F	600	1998	2006	15	47	A530 118L	532689
GSX-R 600	600	2001	2003	16	45	A525 110L	532690
GSF 650 N ABS	650	2005	2006	15	47	A530 116L	532696
RACING SUZUKI GSX-R 750	750	2006	2010	17	45	A520 116L	532732
DR 800 S	800	1991	1993	15	47	A520 116L	532728
GSX-R 1000 #525 END	1000	2001	2006	17	42	A525 110L	532683
SV 1000 S	1000	2003	2007	17	40	A530 108L	532697
GSX-R 1000 #520 RACING	1000	2001	2006	17	42	A520 110L	532698
DL 1000 V-STROM ABS	1000	2014	2019	17	41	A525 116L	532729
GSX-R 1100 #530	1100	1990	1992	15	48	A530 118L	532730
SUZ GSX 1250 F ABS	1250	2010	2016	18	43	A530 118L	532731
GSX 1300 R HAYABUSA	1300	1999	2007	17	40	A530 112L	532669
GSX 1300 R HAYABUSA	1300	2008	2012	18	43	A530 114L	532670



Modèle	Cylindre	Année début	Année fin	Pignon	Couronne	Chaîne	Référence
SYM							
XS 125 K	125	2007	2013	15	39	A428 116	527002
XS 125 K	125	2007	2013	15	39	A428 116L	527002
TRIUMPH							
675 STREET TRIPLE	675	2007	2012	16	47	A525 116L	532492
675 DAYTONA	675	2006	2012	16	47	A520 116L	532521
675 STREET TRIPLE	675	2014	2016	16	47	A525 118L	532585
675 DAYTONA	675	2006	2012	16	47	A525 116L	532589
1050 SPEED TRIPLE	1050	2005	2010	18	42	A530 106L	532620
1050 SPEED TRIPLE	1050	2011	2016	18	43	A530 108L	532673
1050 TIGER	1050	2007	2012	18	44	A530 114L	532738
YAMAHA							
YZF-R 125	125	2008	2016	14	48	A428 132L	482980
TDR 125 DELTABOX	125	1994	2003	16	57	A428 136L	532474
WR 125 X	125	2009	2016	14	53	A428 132L	532477
DT 125 MX	125	1978	1991	16	49	A428 118L	532488
TW 125	125	1999	2001	14	50	A428 122L	532497
MT-125	125	2015	2016	14	48	A428 132L	532498
YBR	125	2006	2006	14	45	A428 118L	482983
SR 125 SE	125	1989	1998	14	49	A428 120L	532501
XV 125	125	1997	2001	13	47	A520 114L	532504
YBR 125 CUSTOM	125	2008	2008	14	43	A428 118L	532523
TW 125	125	2002	2006	14	51	A428 126L	532543
DT 125 X	125	2005	2006	16	57	A428 134L	532569
DT 125 E/F	125	1974	1979	16	37	A428 112L	532582
XT 125 X	125	2005	2011	14	48	A428 126L	532588
XT 125 R	125	2005	2011	14	50	A428 128L	532644
YBR 125	125	2005	2006	14	45	A428 118L	482982
SR 125	125	1999	2003	14	49	A428 120L	532667
DT 125 LC-3	125	1985	1988	16	49	A428 126L	532675
RS 125	125	1975	1975	16	36	A428 112L	532687
TZR 125 R JAPON	125	1993	1995	16	46	A428 140L	532695
TDR 125 BELGARDA	125	1989	1993	16	53	A428 132L	532705
RDX 125 RAYONS	125	1975	1977	15	39	A428 112L	532722
RDX 125 2R6	125	1978	1981	15	39	A428 112L	532723
XVS 125 DRAG STAR	125	2000	2005	16	59	A428 146L	532743
DT 125 E	125	1974	1979	16	37	A428 112	527003
DT 125 LC	125	1985	1988	16	49	A428 126	527004
DT 125 MX	125	1978	1991	16	49	A428 118	527005
DT 125 X	125	2005	2006	16	57	A428 134	527006
MT 125	125	2015	2016	14	48	A428 132	527007
RD 125 DX	125	1978	1981	15	39	A428 112	527008
RD 125 DX	125	1975	1977	15	39	A428 112	527009
RS 125	125	1975	1975	16	36	A428 112	527010



Modèle	Cylindre	Année début	Année fin	Pignon	Couronne	Chaîne	Référence
SR 125	125	1999	2003	14	49	A428 120	527011
SR 125	125	1989	1998	14	49	A428 120	527012
TDR 125	125	1989	1993	16	53	A428 132	527013
TDR 125 R	125	1994	2003	16	57	A428 136	527014
TW 125	125	1999	2001	14	50	A428 122	527015
TW 125	125	2002	2006	14	51	A428 126	527016
TZR 125	125	1993	1995	16	46	A428 140	527017
WR 125 X Supermoto	125	2009	2016	14	53	A428 132	527018
XT 125 R	125	2005	2011	14	50	A428 128	527019
XT 125 X	125	2005	2011	14	48	A428 126	527020
XV 125 Virago	125	1997	2001	13	47	A520 114	527021
XVS 125 Dragstar	125	2000	2005	16	59	A428 146	527022
YBR 125 ED	125	2005	2006	14	45	A428 118	527023
YBR 125 E	125	2006	2006	14	45	A428 118	527024
YB 125 SPD	125	2008	2008	14	43	A428 118	527025
YZF-R 125	125	2008	2016	14	48	A428 132	527026
FZS 600 FAZER	600	1998	2003	15	48	A530 110L	532460
XT 600 E 3TB	600	1990	2003	15	45	A520 106L	532482
XJ6	600	2009	2016	16	46	A520 118L	532493
FZ6 N FAZER	600	2004	2007	16	46	A530 118L	532494
RACINGR6	600	2006	2020	16	45	A520 114L	532508
R6	600	2006	2020	16	45	A525 114L	532514
XJ 600 S DIVERSION	600	1992	2003	16	48	A520 110L	532528
YZF 600 R6 #530	600	1999	2002	16	48	A530 116L	532548
YZF 600 R6 #520 RACING	600	1999	2002	16	48	A520 116L	532593
YZF 600 R THUNDERCAT	600	1996	2003	15	47	A530 108L	532608
YZF 600 R6 #530	600	2003	2005	16	48	A530 116L	532614
XT 600	600	1987	1995	15	39	A520 102L	532632
YZF 600 R6-S #520 RACING	600	2003	2005	16	48	A520 116L	532635
FZ6 S FAZER	600	2004	2007	16	46	A530 118L	532688
XJ 600 DIVERSION	600	1991	2003	16	48	A520 110L	532706
XJ 6 DIVERSION	600	2009	2016	16	46	A520 118L	532707
XT 600 Z TENERE IVJ	600	1986	1986	15	40	A520 104L	532708
YZF 600 R6	600	2006	2020	16	45	A525 114L	532713
XT 600 Z TENERE 3AJ	600	1988	1989	15	40	A520 104L	532724
XT 660 X	660	2004	2016	15	45	A520 110L	532513
XT 660 R	660	2004	2016	15	45	A520 110L	532574
MT-03 N	660	2006	2013	15	47	A520 112L	532709
MT-07 ABS	700	2014	2023	16	43	A525 108L	532473
MT-07 ABS	700	2014	2023	16	43	A525 108L	532473
TRACER 700	700	2016	2019	16	43	A525 114L	532710
MT-07 ABS	700	2014	2023	16	43	A525 108L	532486
MT 07	700	2014	2016	16	43	A525 108	527027
XTZ 750 SUPER TENERE	750	1989	2000	16	46	A520 112L	532602



Modèle	Cylindre	Année début	Année fin	Pignon	Couronne	Chaîne	Référence
YZF 750 R #530	750	1993	1998	16	43	A530 106L	532725
FZ8	800	2010	2016	16	46	A525 122L	532553
TDM 850	850	1996	1998	17	42	A525 114L	532560
TDM 850 4TX4	850	1999	2001	16	43	A525 114L	532591
RUBMT-07 ABS	900	2014	2023	16	45	A525 110L	532486
TDM 900	900	2002	2014	16	42	A525 118L	532529
MT-09	900	2013	2016	16	45	A525 110L	532676
MT 09	900	2013	2016	16	45	A525 110	527028
MT 09 A ABS	900	2014	2020	16	45	A525 110	527029
FZ1 N	1000	2006	2015	17	45	A530 122L	532554
YZF 1000 R1	1000	1998	2003	16	43	A530 114L	532561
FZS1000 FAZER	1000	2001	2006	16	44	A530 116L	532592
YZF 1000 R1	1000	2006	2008	17	45	A530 118L	532633
YAM YZF-R1/ M # 520 RACING	1000	2015	2022	16	41	A520 114L	532634
1000 R1	1000	2009	2014	17	47	A530 120L	532655
YZF-R1/ M	1000	2015	2022	16	41	A525 114L	532656
YZF 1000 R1	1000	2004	2005	17	45	A530 116L	532711
YZF 1000 R1 #520 RACING	1000	1998	2003	16	43	A520 114L	532727
MT 10	1000	2016	2021	16	43	A525 114	527030
FJ1200	1200	1986	1995	17	40	A530 110L	532712
XJR 1300	1300	1998	2001	17	38	A530 110L	532535
XJR 1300	1300	2002	2003	18	39	A530 112L	532726
MT-01	1670	2005	2012	17	39	A530 114L	532668



485372



485373



485374



485375



505037

/ CHAINES

Description	Réf.
CHAÎNE 420 AFAM 134M RENFORCEE OR	485372
CHAÎNE 428 AFAM 134M STANDARD	485373
CHAÎNE 420 AFAM 134M SUPER RENFORCEE OR (RACING)	485374
CHAÎNE 428 AFAM 134M RENFORCEE OR	485375
CHAÎNE 420 AFAM 140M RENFORCEE OR	505037

/ INDEX ALPHABÉTIQUE

A

Adaptateur rétroviseur 200
 Aimant 445
 Alarme 503
 Alesoir 443
 Allumage 11 > 26
 Ampoule 313 > 318
 Anti-crevaisson 481
 Antiparasite 777 > 803
 Antivol 502 > 503
 Arbre à came 32
 Arrache volant 438 > 439
 Arrache roulement 442
 Autocollant 94 > 101
 Augmentateur 449
 Avertisseur 302,
 Axe kick 203
 Axe de piston 39

B

Bac vidange 486
 Balance de précision 466
 Bande plaque
 d'immatriculation 492
 Barillet 539
 Bas de caisse 299
 Batterie 542 > 651
 Baume cuir 426
 Béquille 200 > 202, 476
 Bloc CDI 18
 Bloc levier 129
 Bloc fourche 478
 Bloc piston 440
 Bloc roue 129
 Bloc variateur 440
 Bobine CDI/haute tension 18
 Bobine haute tension 18
 Bobine papier 476
 Boisseau carburateur 25
 Boîte de vitesse 471
 Boîtier électronique 19
 Bombe anti-crevaisson 426
 Bombe de peinture 102 > 105
 Bouchon d'huile 79
 Bouchon de vase
 d'expansion eau 80
 Bouchon de vidange 487
 Bouchon durite 436
 Bouchon radiateur 83
 Bouchon silencieux 476
 Bougie 652 > 775
 Boulonneuse à choc 469
 Broc 435, 437
 Brosse 471
 Buffer 480
 Burette 436

Burin 465

C

Câble de coffre 106
 Câble de compteur 109 > 120
 Câble d'embrayage 140 > 153
 Câble de frein 131 > 134
 Câble de gaz 156 > 184
 Câble starter 134 > 140
 Cache orifice 307
 Caisse outil 471
 Cale isolante 26
 Cale 466
 Calorstat 80
 Capteur CDI 22
 Carburateur 26 > 29
 Carburateur 399 > 400
 Cardan 449
 Carrosserie 296 > 301
 Centrale de clignotant 302
 Chaîne 1209
 Chaîne de distribution 33
 Chambre à air 368
 Chasse joint 463
 Clapet 486
 Clapet anti-retour 486
 Clavette allumage 25
 Clé 446
 Clé à bougie 441
 Clé dynamométrique 448
 Clé hexagonale 447 > 448
 Clé mâle 447 > 448
 Clé mixte 446 > 447
 Clé à molette 446
 Clé à fitre 473
 Clé à pipe 446
 Clé à rayon 445
 Clé de sangle 473
 Clignotant 303 > 306
 Cliquet 39, 448
 Cloche d'embrayage 75
 Coffret cliquet 449
 Coffret de douille 449
 Coffret embouts 455
 Coffret foret 452
 Colle 483
 Collier échappement 39
 Collier de serrage 80
 Collier durite eau 80
 Collier durite d'essence 29
 Collier durite
 de refroidissement 80
 Collier rilsan 485
 Commande starter 26
 Commodo 308

Comprime ressort 443, 445
 Compte-tours 108
 Compteur 107 > 108
 Condensateur 22
 Contacteur de stop 309
 Contacteur interrupteur 308 > 309
 Coque Clignotant 303
 Coupelle ressort 33
 Couronne démarreur 19
 Courroie 1216 > 1198
 Culasse 34 > 35
 Cutter 464
 Cylindre 34 > 35

D

Décapeur thermique 468
 Démarreur 20 > 21
 Demi-coquille 32
 Démonte embrayage 444
 Démonte pneu 482
 Démonte soupape 443
 Démonte pneu 479
 Démultiplicateur
 de compteur 108
 Dérive chaîne 443
 Détecteur de fuite 481
 Disque capteur 108
 Disque d'embrayage 76
 Disque de frein 882 > 873
 Disque de meuleuse 471
 Doseur 437
 Dosseret 523
 Double optique 298
 Douille 448, 450
 Durite eau 81
 Durite essence 29, 30
 Durite mise à l'air 32
 Durite pompe à huile 32

E

Eau déminéralisée 405
 Écarteur de plaquette
 de frein 486
 Échappement 42 > 73
 Éclairage 302 > 319
 Éclairage de plaque 310
 Écran de lunettes/masque 522
 Écrou hexagonal 491
 Écrou pans 491
 Écrou d'embrayage 76
 Écrou de rayon 204
 Écrou fixation 39
 Efface rayure 426
 Embiillage 74
 Embout 451
 Embout de gonflage 474
 Embout de guidon 126 > 127

Embrayage 76 > 77
 Engrenage 79
 Enrouleur 474
 Entonnoir 473
 Epoxy 484
 Équipement véhicule 504 > 519
 Etabli 472
 Etaou 472
 Extracteur 442, 451

F

Feu 307
 Feu arrière 311
 Feu arrière décoratif 312
 Fer à souder 468
 Fil bougie 19
 Filière 453
 Filetage 454
 Filtre à air 807
 Filtre à huile 806
 Filtre essence 30, 31
 Fond de jante 375
 Forêt 452
 Fourche 206
 Fraise 453
 Frein filet 483, 484
 Freinage 861

G

Galet 88
 Gant de travail 476
 Garde-boue 297
 Gicleur 443
 Goujon 32, 33
 Graisse 403 > 404
 Graisse chaîne 397
 Grille de protection déco 301
 Grille de radiateur 83
 Guidon 121 > 124

H

Housse de selle 509
 Huile 380 > 393, 408 > 419
 Huile filtre 398

I

Immatriculation 492 > 499
 Imprimante plaque
 d'immatriculation 493

J

Jerrican 436
 Jeu de direction 204 > 205
 Joint 38
 Joint carter 78
 Joint couvercle culasse 32
 Joint couvercle pompe à eau 80
 Joint culasse 33, 35
 Joint cylindre 33

Joint étanchéité.....	487	Numéro.....	94>96	Protège jambe.....	301	Silentbloc.....	40, 83
Joint haut moteur.....	35>37	O		Protège main.....	129	Sonde de température.....	83, 108
Joint moteur.....	38	Obtuteur de pompe à huile..	437	Purgeur.....	485	Soufflette.....	473
Joint pipe d'admission.....	26	Optique.....	310	R		Soupape.....	33
Joint plat.....	79	Outil réparation de valve.....	481	Raccord/connecteur en T.....	32	Starter.....	26
Joint pompe à eau.....	80	Outillage.....	438	Radiateur.....	83	Stator.....	22>24
Joint pot échappement.....	39	P		Rallonge.....	307	Support compteur.....	109
Joint queue soupape.....	33	Papier à poncer.....	485	Rapeur.....	480	Support de plaque.....	295
Joint SPI.....	207>294	Pâte à joint.....	482	Rayon.....	204	Support de phare.....	295
Joint SPI embiellage/vilo.....	74	Pâte à pneu.....	396, 479	Réchauffeur/résistance.....	26	Support moto.....	479
Joint SPI de pompe a eau.....	80	Pâte à roder.....	485	Récupérateur de fluide.....	486	Support pour stand.....	477, 479
Joint tendeur de chaîne.....	32	Patte/support phare.....	318	Réducteur.....	451	Support pour vignette.....	295
Joint torique.....	79	Pédale.....	202	Réglage amortisseur.....	445	Support smartphone.....	513
L		Perceuse.....	470	Réglage culbuteur.....	443	Surpontet.....	128
Laine silencieux.....	40	Perceuse/visseuse.....	469	Régulateur de pression		T	
Lampe.....	313	Phare.....	310	injection.....	32	Tablier.....	301, 514>519
Lame scie.....	464	Pierre rodoir de cylindre.....	442	Régulateur de tension.....	12	Tambour d'embrayage.....	75
Lapidaire.....	471	Pige de calage.....	467	Relais de démarreur.....	21	Tapis.....	478
Lettre.....	498	Pignon lanceur démarreur.....	21	Repose-pied.....	202	Taraud.....	453>454
Lève/moto.....	477	Pignon pompe à huile.....	75	Résistance de clignotant.....	307>308	Té de fourche.....	206
Levier.....	154	Pince.....	461>463	Ressort.....	41	Tendeur de chaîne.....	33
Levier d'embrayage.....	129	Pince à clip.....	462>463	Ressort embrayage.....	78	Tête de fourche.....	297>299
Levier de frein.....	129>131	Pinceau pâte à pneu.....	479	Ressort bequille.....	201	Tire valve.....	481
Levier de starter.....	134	Pion centrage culasse.....	33	Ressort repose pied.....	202	Top-case/sacoche.....	523>539
Levier poignée.....	154	Pipe d'admission.....	25	Ressort pot.....	41	Tournevis.....	460>461
Limiteur régime moteur.....	21	Pistolet de gonflage.....	474	Rétroviseur.....	194>199	Tournevis à cliquet.....	460
Liquide de frein.....	396	Piston.....	38	Revêtement.....	185>193	Tournevis à percussion.....	465
Liquide de refroidissement.....	395	Plaque d'immatriculation.....	492	Rive chaîne.....	444	Tournevis cruciforme.....	460
Lime.....	463	Plaquette de frein.....	874>1169	Rivet.....	491, 498	Tournevis électrique.....	469
Lubrifiant.....	402	Plomb.....	498	Robinet essence.....	31	Tournevis Torx.....	456, 460, 461
Lubrification.....	378>437	Pneu cyclo.....	362	Rodoir de cylindre.....	442	Tourne à gauche.....	453
Lunettes.....	520>522	Pneu moto.....	342	Rondelle.....	33, 490, 491	Transmission	
Lustreur.....	402, 432	Pneu scooter.....	322	Roue-libre démarreur.....	20	de compteur.....	109>120
M		Pneumatique.....	321	Rouleau/galets.....	88>91	Tube de fourche.....	206
Mâchoire de frein.....	874>1169	Poignée coulissante.....	451	Roulement.....	75, 78, 203, 206	V	
Manchon.....	203	Poignée d'embrayage.....	140	Roulement carter.....	78	Valve.....	481
Manchon sélecteur.....	504	Poignée de frein.....	131	Roulement de direction.....	206	Variateur.....	84>87
Marche-pieds.....	202	Poignée de gaz.....	154>156	Roulement engrenage.....	78	Verin selle.....	106
Marqueur.....	105	Poignée pistolet.....	105	Roulement roue.....	203	Ventilateur.....	83
Marteau.....	464	Poinçon.....	444	Roulement vilo.....	75	Vis 6 pans.....	488
Masque.....	520>522	Pompe à eau.....	81>82	Ruban adhésif.....	484	Vis carrosserie.....	489
Masse/plond.....	481	Pompe à essence.....	31	Rupteur.....	22	Vis fixation disque frein.....	490
Massette.....	465	Pompe à graisse.....	435	Rustine.....	480	Vis réglage.....	33
Meuleuse.....	470	Pompe à huile.....	32, 75	S		Visserie.....	488
Module servante.....	456>459	Pompe à vidange.....	436	Sac à outils.....	471	Visseuse.....	469>470
Mordache.....	445	Pontet.....	127>128	Sacoche.....	539		
Mousse de guidon.....	124>125	Porte ampoule/lampe.....	318	Sangle tete de fourche.....	295		
Multimetre.....	466	Porte filière.....	454	Sangle.....	478		
N		Porte fusible.....	21	Savon.....	404>405, 426		
Nécessaire de réparation		Porte vignette.....	295	Scie.....	464		
chambre à air.....	480	Presse ressort.....	444	Selle.....	106		
Nettoyeur bac ultrason.....	474	Projecteur.....	310, 315>317	Seringue ajustement.....	445		
Nettoyant.....	398, 399, 403	Protection pot.....	41	Servante.....	472		
Noix de kick.....	203	Protection de fourche.....	299	Siège enfant.....	539		

/ INDEX ALPHABÉTIQUE ANGLAIS

A	Chain tensioner 33	Drill.....470	Grinder.....470
Adhesive tape..... 484	Chain..... 1209	Drill/screwdriver..... 469	H
Adjustable wrench..... 446	Check valve..... 486	Dual optics.....298	Half shell 32
Adjustment screw 33	Child seat.....539	E	Hallmark..... 444
Air filter807	Chisel.....465	Electric screwdriver..... 469	Hammer..... 464
Alarm..... 503	Choke cable134>140	Electronic box..... 19	Hand protector.....129
Anti-puncture spray.....426	Choke control 26	Engine gasket 38	Handle lever154
Apron 301, 514>519	Choke lever134	Engine speed limiter 21	Handlebar end.....126>127
B	Clamp..... 461>463	Epoxy 484	Handlebar foam124>125
Backsplash 523	Cleaner 398, 399, 403	Exhaust.....42>73	Handlebar121>124
Bag 539	Clip pliers 462>463	Exhaust clamp 39	Headlight bracket.....295
Barrel..... 539	Clutch 76>77	Exhaust gasket 39	Headlight bracket.....318
Battery.....542>651	Clutch bell 75	Extension.....307	Headset204>205
Bearing puller.....442	Clutch cable140>153	Extractor.....442, 451	Heat gun..... 468
Bearing.....75, 78, 203, 206	Clutch disc 76	F	Heater/resistance 26
Belt1216>1198	Clutch drum 75	Fan..... 83	Hexagon screw 488
Bench.....472	Clutch handle140	File 463	Hexagonal nut.....491
Bit box455	Clutch lever129	Filter oil.....398	Hexagonal wrench.....447>448
Blow gun.....473	Clutch nut 76	Fitter wrench.....473	High engine gasket 35>37
Bodykit.....296>301	Clutch remover 444	Fixing nut..... 39	High voltage coil.....18
Bodywork screws489	Clutch spring 78	Flap..... 486	Hose cap.....436
Brake cable.....131>134	Coating185>193	Flasher resistor307>308	Hose clamp80
Brake disc fixing screw490	Combination wrench446>447	Flasher unit.....302	Hose vented to air.....32
Brake disc 882>873	Commodo 308	Flashing 303>306	Housing bearing 78
Brake fluid.....396	Coolant.....395	Flat gasket..... 79	I
Brake handle 131	Cooling hose clamp80	Flat nut.....491	Ignition wrench 25
Brake lever.....129>131	Counter.....107>108	Fluid recuperator..... 486	Ignition11>26
Brake pad spacer..... 486	Crank assembly 74	Footrest spring.....202	Impact screwdriver465
Brake pad..... 874>1169	Crankcase gasket..... 78	Footrest202	Impact wrench..... 469
Brake shoe..... 874>1169	Crutch200>202, 476	Fork..... 206	Increaser 449
Braking.....861	Cutter..... 464	Fork block.....478	Indicator Shell 303
Breaker 22	Cyclo tire.....362	Fork head strap.....295	Inflation gun474
Bridge.....128	Cylinder head34>35	Fork head..... 297>299	Inflation nozzle474
Brush.....471	Cylinder head centering pin 33	Fork protection299	Injection pressure regulator 32
Buffer.....480	Cylinder head cover gasket 32	Fork tube 206	Inlet pipe 25
Bulb/lamp holder318	Cylinder head gasket33, 35	Fuel filter..... 30,31	Inner tube368
Burette.....436	Cylinder honing stone442	Fuel hose clamp 29	Insulating wedge 26
C	Cylinder honing442	Fuel hose 29, 30	Intake pipe gasket 26
Calorstat80	Cylinder seal 33	Fuel pump 31	J
Camshaft..... 32	Cylinder.....34>35	Fuel tap..... 31	Jerrycan436
Capacitor 22	D	Funnel473	Joint compound.....482
Carburetion..... 399>400	Decorative protection grid301	Fuse holder 21	Kicker axle.....203
Carburetor26>29	Decorative rear light312	G	Kicker nut.....203
Carburetor bushel 25	Demineralized water 405	Gas cable 156>184	Kickstand spring201
Cardan 449	Die holder454	Gasket..... 38	L
Carpets.....478	Dimmer block440	Gear bearing..... 78	Lamp.....313
Cattail.....465	Dimmer84>87	Gear..... 79	Lapidary.....471
CDI block..... 18	Doser.....437	Gearbox.....471	Lapping paste.....485
CDI sensor..... 22	Drain plug487	Glasses.....520>522	Lead498
CDI/high voltage coil.....18	Drain pump.....436	Glasses/mask screen..... 522	Leak detector481
Chain bank..... 444	Drain tray486	Glue.....483	Leather balm.....426
Chain drift.....443	Drill bit452	Grease pump.....435	Leg protector.....301
Chain grease397	Drill box452	Grease.....403>404	Letter498
Chain tensioner joint..... 32	Drill.....453	Grinder disc.....471	Lever block.....129

Lever	154	Polisher	402, 432	Socket	448, 450	Transmission Trap	485	
License plate lighting.....	310	Pot protection.....	41	Socket box	449	Trigger guard	127>128	
License plate strip.....	492	Pot spring	41	Soldering iron.....	468	Triple clamp.....	206	
License plate.....	492	Precision balance	466	Spark plug cap.....	777>803	Trunk cable.....	106	
Lift/motorcycle	477	Projector.....	310, 315>317	Spark plug wire	19	Turn left	453	
Light	307	Puncture protection	481	Spark plug wrench.....	441	U		
Light bulb.....	313>318	R	Radiator cap.....	83	Spark plug	652>775	Ultrasonic tank cleaner.....	474
Lighthouse	310	Radiator grille.....	83	Speedometer cable	109>120	Underbody	299	
Lighting	302>319	Radiator	83	SPI crankshaft.....	74	V		
Lock.....	502>503	Radius.....	204	Spoke nut	204	Valve	33	
Lubricant	402	Rapper	480	Spoke wrench	445	Valve pull.....	481	
Lubrication	378>437	Ratchet box.....	449	Spray paint	102>105	Valve remover.....	443	
M		Ratchet screwdriver.....	460	Spring compress	443, 445	Valve repair tool.....	481	
Magnet.....	445	Ratchet	39, 448	Spring cup	33	Valve stem seal	33	
Male wrench.....	447>448	Reamer	443	Spring press	444	Valve.....	481	
Marker	105	Rear light.....	311	Spring.....	41	Vehicle equipment.....	504>519	
Mask	520>522	Rear view mirror adapter.....	200	Stand support.....	477, 479	Vignette holder	295	
Meter support.....	109	Rearview mirror	194>199	Starter crown	19	Vilo bearing	75	
Meter.....	109>120	Reducer	451	Starter relay.....	21	Vise.....	472	
Mordache	445	Registration	492>499	Starter thrower pinion	21	Voltage regulator	12	
Motorcycle support	479	Rev counter.....	108	Starter	20-21	W		
Motorcycle tire.....	342	Rilsan necklace	485	Starter crown	19	Warning.....	302,	
Mudguards	297	Rim tape	375	Stator	22>24	Washer	33, 490, 491	
Multimeter	466	Rivet	491, 498	Steering bearing.....	206	Water expansion tank cap.....	80	
Multiplier meter	108	Rocker arm adjustment.....	443	Steering wheel puller	438>439	Water hose	81	
Nozzle	443	Roller/rollers	88>91	Steps	202	Water hose clamp	80	
Number.....	94>96	S	Saddle cover	295	Sticker support	295	Water pump gasket.....	80
O		Saddle cylinder	106	Sticker	94>101	Water pump SPI seal.....	80	
Oil cap	79	Saddle	106	Stop switch	309	Water pump	81>82	
Oil filter.....	806	Saw blade	464	Strap key	473	Wedge.....	466	
Oil pump gear	75	Saw	464	Strap.....	478	Weight/plunge.....	481	
Oil pump hose.....	32	Scooter tire	322	Stud.....	32, 33	Wheel bearing.....	203	
Oil pump shutter	437	Scratch eraser.....	426	Switch contactor	308>309	Wheel block.....	129	
Oil pump	32, 75	Screwdriver	460>461	Syringe adjustment.....	445	Winder	474	
Oil seal	207>294	Screwdriver	469>470	T		Work glove.....	476	
Oil.....	380>393, 408>419	Screws.....	488	T fitting/connector	32	Wrench.....	446	
Optics.....	310	Seal flush	463	Tap.....	453>454			
Orifice cover	307	Sealing gasket.....	487	Temperature probe.....	83, 108			
O-ring.....	79	Sector	453	Thread lock	483, 484			
P		Selector sleeve	504	Thread.....	454			
Paper reel	476	Sensor disc	108	Throttle grip	154>156			
Paper sand	485	Servant.....	472	Timing chain.....	33			
Patch	480	Serving module	456>459	Timing pin.....	467			
Pebble.....	88	Shock absorber	445	Tip.....	451			
Pedal.....	202	adjustment	445	Tire changer	479			
Phillips screwdriver.....	460	Silencer plug.....	476	Tire paste brush.....	479			
Pipe wrench	446	Silent wool	40	Tire paste.....	396, 479			
Pistol grip.....	105	Silentbloc.....	40, 83	Tool bag.....	471			
Piston block.....	440	Sleeve	203	Tool box	471			
Piston pin	39	Sliding handle.....	451	Tools	438			
Piston	38	Smartphone holder	513	Top case/bag.....	523>539			
Pitcher.....	435, 437	Soap	404>405, 426	Torque wrench	448			
Plate support	295			Torx screwdriver	456, 460, 461			
Pneumatic	321							

/ CONDITIONS GÉNÉRALES DE VENTE DE LA SOCIÉTÉ CGN

Préambule

Les présentes conditions générales de vente ont pour objet de définir les conditions dans lesquelles la société C.G.N. commercialise les Produits auprès des Distributeurs qu'elle a sélectionnés.

1. Définitions

Les termes et expressions utilisés dans les présentes Conditions Générales de Vente avec une majuscule auront le sens suivant :

- « **C.G.N.** » désigne la société C.G.N. - CENTRE GROSSISTE NANTAIS, société par actions simplifiée, au capital de 1 200 000 euros, dont le siège social est situé boulevard Salvador Allende, Zone Atlantis, 44800 Saint Herblain, immatriculée au registre du commerce et des sociétés de Nantes sous le numéro 343 863 460, numéro de téléphone : 02.40.92.00.95, adresse email : contact@cgnfrance.com.
- « **Compte Distributeur** » désigne le compte, tel que décrit à l'article 4 des présentes, créé par un Distributeur.
- « **Conditions Générales de Vente** » désigne les présentes conditions générales de vente applicables aux relations entre C.G.N. et le Distributeur.
- « **Conditions Particulières** » désigne les conditions particulières conclues entre C.G.N. et le Distributeur et ayant pour objet de compléter les présentes Conditions Générales de Vente, en précisant notamment la nature et la quantité des Produits fournis au Distributeur et leurs modalités de livraison. Les Conditions Particulières prennent la forme d'un bon de commande émis par le Distributeur, et accepté par C.G.N.
- « **Distributeurs** » désigne les Professionnels, sélectionnés par C.G.N., qui commercialisent les Produits proposés par C.G.N.
- « **Point de livraison** » désigne le point de livraison convenu entre C.G.N. et le Distributeur, tel que spécifié aux Conditions Particulières.
- « **Produits** » désigne les produits proposés à la vente aux Distributeurs, tels que ces produits sont décrits à l'article 3 des présentes. Le détail des Produits fournis par C.G.N. au Distributeur est précisé dans les Conditions Particulières.
- « **Professionnel** » désigne toute personne physique, représentant ou non une personne morale, agissant à des fins entrant dans le cadre de son activité professionnelle.
- « **Site Internet** » désigne le site internet hébergé à l'adresse internet suivante : www.cgnfrance-pro.com.
- « **TVA** » désigne la taxe sur la valeur ajoutée française.

2. Acceptation des Conditions Générales de Vente

Les Conditions Générales de Vente déterminent les conditions contractuelles applicables aux relations entre C.G.N. et le Distributeur.

Le Distributeur est tenu de lire attentivement les Conditions Générales de Vente avant de recourir aux Produits proposés par C.G.N. Ces Conditions Générales de Vente contiennent des informations importantes sur les droits et obligations du Distributeur, ainsi que sur les limitations et exclusions de responsabilité de C.G.N.

En recourant aux Produits de C.G.N., le Distributeur confirme son adhésion entière et sans réserve aux Conditions Générales de Vente, ce qui est expressément reconnu par le Distributeur, qui renonce, en particulier, à se prévaloir de tout autre document qui serait inopposable à C.G.N. Si le Distributeur n'accepte pas les Conditions Générales de Vente, il est prié de ne pas recourir aux Produits de C.G.N.

3. Produits

C.G.N. propose, à titre principal, des produits finis, des pièces détachées et des accessoires pour les véhicules deux-roues motorisés (motos, scooters, cyclomoteurs) et pour les vélos ainsi que des équipements pour les pilotes et les cyclistes.

Les Produits proposés par C.G.N. font l'objet d'une présentation et d'une description spécifique dans les Conditions Particulières. Le Distributeur est invité à vérifier, avant d'effectuer une commande de Produits, que ceux-ci correspondent bien à ses besoins.

4. Modalités de distribution des Produits – Compte Distributeur

Afin d'assurer une distribution conforme aux exigences de qualité et de sécurité en faveur du client final, C.G.N. a mis en place un réseau de distribution sélective sur la base de critères objectifs.

Tout nouveau Distributeur devra donc effectuer, une demande d'ouverture d'un Compte Distributeur et, à cette fin, respecter les conditions cumulatives suivantes :

- (i) Être immatriculé au Registre du commerce et des sociétés ou au Répertoire des métiers ;
- (ii) Justifier d'une qualification professionnelle et/ou d'une expérience professionnelle en rapport avec la mécanique et la maintenance des cycles et cyclomoteurs, afin de pouvoir conseiller les acheteurs et assurer un service après-vente ;
- (iii) Disposer d'un « établissement recevant du public » (ERP) au sens de l'article R123-2 du Code de la construction et de l'habitation) comprenant un équipement suffisant et approprié permettant au Distributeur d'assurer la vente, le montage, la maintenance et un service après-vente des cycles, véhicules à moteur à deux ou trois roues et quadricycles à moteur (véhicules de catégorie L) ;
- (iv) S'engager à ne pas modifier les Produits et à ne les monter ou les revendre que dans des conditions conformes à leur affectation et performance prévues, sans détournement d'usage, et conformément le cas échéant aux instructions du fabricant et aux obligations légales et réglementaires.

C.G.N. se réserve le droit de refuser toute demande d'ouverture d'un Compte Distributeur si les conditions susvisées ne sont pas remplies.

Le Distributeur dont la demande d'ouverture d'un Compte Distributeur a été acceptée par C.G.N. peut effectuer des commandes de Produits selon les modalités prévues à l'article 5.

En l'absence de commande par un Distributeur pendant une période de douze (12) mois consécutifs, son Compte Distributeur sera clôturé automatiquement. Le Distributeur devra alors faire une nouvelle demande d'ouverture de Compte Distributeur pour effectuer des commandes de Produits.

5. Commande

Toute commande de Produits est effectuée par le Distributeur est invité à remplir un bon de commande qui est automatiquement transmis à C.G.N. Une commande n'est valable qu'après acceptation expresse par C.G.N.

C.G.N. se réserve le droit d'accepter ou refuser toute demande de modification ultérieure d'une commande passée par un Distributeur et acceptée par C.G.N.

6. Conditions financières

6.1. Prix

Nos prix sont ceux figurant au catalogue. Cependant, en raison des variations constantes du cours des matières premières, du cours des changes et des tarifications de transport, nos prix sont donnés sans engagement et peuvent être modifiés sans avis préalable. Les prix facturés sont ceux en vigueur le jour de la livraison.

Les frais de port, le coût éventuel de l'assurance, ainsi que tout autre frais supplémentaire le cas échéant, sont également précisés dans les Conditions Particulières.

Les prix sont en euros, entendus hors taxes et hors TVA. La TVA applicable au jour de la commande par le Distributeur est ajoutée au prix des Produits. Tout changement du taux de TVA pourra être répercuté sur le prix des Produits.

6.2. Modalités de paiement

Sous réserve des stipulations figurant dans les Conditions Particulières, le prix des Produits est payé, par principe, selon les modalités décrites ci-après.

6.2.1. Distributeurs en France métropolitaine

Le règlement de chaque commande a lieu avant l'expédition ou au plus tard au moment de la livraison, par contre-remboursement, pendant une durée minimum d'un an à compter de l'ouverture d'un Compte Distributeur ainsi que pour tout Distributeur dont le montant mensuel moyen de commande sur un an est inférieur à 299,00 euros hors taxes.

Dans tous les autres cas, le règlement a lieu par lettre de change relevé (LCR) soit à échéance 30 jours fin de mois le 25, soit, si l'échéance est postérieure, avec un escompte de 0,5% par mois du montant hors taxes dû par le Distributeur.

Nonobstant ce qui précède, C.G.N. se réserve le droit de demander le règlement intégral d'une commande avant son expédition notamment à tout Distributeur qui ne présenterait pas de garanties suffisantes.

6.2.2. Distributeurs hors France métropolitaine

Le règlement de chaque commande a lieu avant l'expédition.

C.G.N. se réserve le droit d'exiger un engagement bancaire en garantie du paiement du prix par le Distributeur.

6.3. Réserve de propriété

Les Produits vendus au Distributeur restent la propriété exclusive de C.G.N. jusqu'au complet paiement par le Distributeur du prix total desdits Produits, en principal et en accessoire. Les paiements effectués par le Distributeur ne seront considérés comme définitifs qu'après encaissement effectif par C.G.N. des sommes dues. Ne constitue pas un paiement au titre de cet article, la remise d'un titre créant une obligation de payer.

Nonobstant ce qui précède, les risques de perte et d'endommagement des Produits sont transférés au Distributeur à compter de leur remise au transporteur par C.G.N. En conséquence, le Distributeur est tenu de souscrire une assurance, à ses frais, pour le compte de C.G.N.

En cas de défaut de paiement à l'échéance par le Distributeur, C.G.N. pourra exercer son droit de reprise sur les Produits en possession du Distributeur. La restitution des Produits appartenant à C.G.N. se fera aux risques et périls du Distributeur. En cas de revente des Produits par le Distributeur, la revendication de C.G.N. pourra s'exercer sur le prix perçu par le Distributeur.

Le Distributeur s'engage à informer ses clients de l'existence de ladite clause de réserve de propriété et du droit de C.G.N. de revendiquer, si nécessaire, les Produits entre leurs mains.

6.4. Pénalités de retard

En cas de non-paiement à bonne date par le Distributeur de toute somme due à C.G.N., et en application du douzième alinéa de l'article L441-6 du Code de commerce, le montant des pénalités de retard sera fixé à trois fois le taux d'intérêt légal en vigueur au jour de la défaillance du Distributeur.

En cas de retard de paiement, C.G.N. pourra immédiatement suspendre la fourniture des Produits au titre des commandes en cours, sans indemnité pour le Distributeur.

6.5. Indemnité forfaitaire pour frais de recouvrement

En application de l'article D 441-5 du Code de commerce, le montant de l'indemnité forfaitaire pour frais de recouvrement est fixé à quarante (40) euros.

Cette indemnité, distincte des pénalités de retard, est due de plein droit par le Distributeur défaillant, sans préjudice du droit pour C.G.N. de demander une indemnisation complémentaire dans le cas où celle-ci justifie de frais de recouvrement supérieurs à ce montant. Notamment, les frais bancaires générés par les LCR impayées seront à la charge du Distributeur défaillant.

6.6 Frais de logistique

Toutes les commandes dont le montant est inférieur ou égal à 76,00 € HT. (total H.T des produits sans frais de port, sans frais divers, sans escompte ...) seront majorées de 5,00 € HT pour frais de logistique.

7. Livraison

C.G.N. livre les Produits en France métropolitaine et dans les pays indiqués sur le Site Internet.

7.1. Modalités de livraison

C.G.N. n'assure aucune livraison pour toute commande d'un montant inférieur à 76,00 euros hors taxes et le Distributeur devra en prendre possession directement sur le site de C.G.N.

Dans tous les autres cas, les Produits sont livrés au Point de livraison spécifié dans les Conditions Particulières.

7.2. Frais de livraison

Les frais de transport et de livraison et sont spécifiés dans les Conditions Particulières.

Pour une livraison en France métropolitaine, les Produits sont livrés franco de port pour toute commande au moins égale à 299,00 euros hors taxes (hors produits finis). Par exception, pour toute commande passée entre le mardi 18 heures et le mercredi à minuit, le montant minimum permettant de bénéficier d'une livraison franco de port est de 190,00 euros hors taxes (hors produits finis)

Pour une livraison hors France métropolitaine (ex DOM TOM et Export), les frais de port, le coût éventuel de l'assurance, ainsi que tout autre frais supplémentaire lié à la livraison le cas échéant, sont à la charge exclusive du Distributeur. Notamment, les droits et taxes acquittés le cas échéant par C.G.N. dans le cadre d'une livraison hors France métropolitaine sont à la charge du Distributeur.

7.3. Délais de livraison

Le délai de livraison des Produits est indiqué dans les Conditions Particulières. Il s'agit d'un délai moyen estimé selon les caractéristiques de la commande concernée et le Point de livraison convenu. Ce délai court à compter de l'acceptation par C.G.N. de la commande du Distributeur.

En cas de dépassement du délai communiqué au Distributeur, C.G.N. s'engage à en informer celui-ci dès que possible par tout moyen écrit.

Le non-respect du délai de livraison communiqué au Distributeur ne pourra justifier une annulation de la commande par le Distributeur et ne pourra engager la responsabilité de C.G.N.

7.4. Risques liés au transport – Assurances

7.4.1. Risques liés au transport

Les risques de perte et d'endommagement des Produits sont transférés au Distributeur à compter de leur remise au transporteur par C.G.N.

7.4.2. Assurances

En toute hypothèse, les frais d'assurance sont à la charge du Distributeur.

7.4.3. Contestation

Il appartient au Distributeur, ou au tiers désigné par lui, de vérifier l'état et le contenu des colis reçus en présence du transporteur.

En cas de dommages constatés sur les Produits, le Distributeur doit refuser le colis en indiquant « Refusé : Produit endommagé » sur le récépissé de livraison. Si le Distributeur accepte néanmoins le colis, il doit émettre, sur le récépissé de livraison, toutes les réserves nécessaires en indiquant les dommages constatés sur les Produits.

Tout colis accepté par le Distributeur sans réserve émise sur le récépissé de livraison du transporteur sera réputé avoir été livré en bon état et dans son intégralité, sans préjudice de la garantie visée à l'Article 9, dont bénéficie le Distributeur.

Toute contestation par le Distributeur relative à la conformité des Produits fournis par C.G.N. devra être notifiée à celle-ci à réception des Produits par le Distributeur, par tout moyen écrit permettant d'en accuser réception.

8. Obligations et responsabilité du Distributeur

Le Distributeur est chargé de définir avec précision ses besoins avant de recourir aux Produits proposés par C.G.N. C.G.N. ne pourra être tenue pour responsable d'une mauvaise identification par le Distributeur de ses besoins ou de ses contraintes.

Le Distributeur s'engage à :

- (i) Ne pas modifier les Produits vendus par C.G.N. ;
- (ii) Ne monter ou revendre les Produits vendus par C.G.N. que dans des conditions conformes à leur affectation et performance prévues, sans détournement d'usage, et conformément le cas échéant aux instructions du fabricant et aux obligations légales et réglementaires ;
- (iii) Ne pas modifier, cacher ou altérer de quelque manière que ce soit les marques et logos apposés sur les Produits.

C.G.N. ne pourra en aucun cas être tenue responsable de tout préjudice ou dommage résultant d'un manquement du Distributeur ou de ses préposés au titre de ce qui précède.

9. Garantie de C.G.N.

C.G.N. garantit le Distributeur contre tout vice caché des Produits, dans les limites et conditions acceptées par les fabricants, à l'exclusion de toute négligence ou faute du Distributeur et à l'exclusion des Produits ayant fait l'objet d'une utilisation.

Sont notamment considérés comme une négligence ou faute du Distributeur le non-respect de ses obligations prévues à l'article 8.

C.G.N. s'engage à ce titre au remplacement de la pièce défectueuse à l'exclusion de toute indemnisation ou reprise du Produit contre remboursement, et uniquement après acceptation de la garantie du fabricant.

10. Retour de marchandises

En toute hypothèse, tout retour de Produit nécessite l'accord préalable de C.G.N. Aucun échange de Produit ne sera accepté, sauf erreur de la part de C.G.N. Tout colis devra être retourné en port payé. Les retours de pièces ou Produits non conformes à la commande doivent être accompagnés du numéro et de la date de la facture dans un délai maximum de douze (12) mois et dans leur emballage d'origine. Si l'erreur incombe à C.G.N., les frais de port seront remboursés. Tout retour de Produit dû à une erreur de commande imputable au Distributeur fera l'objet d'un avoir correspondant auquel sera appliqué un abattement de 20%.

11. Responsabilité de C.G.N.

11.1. Responsabilité

La responsabilité de C.G.N. ne peut être engagée qu'en cas de faute ou de négligence prouvée de cette dernière et est limitée aux préjudices directs à l'exclusion de tout préjudice indirect, de quelque nature que ce soit, incluant notamment les dommages aux biens du Distributeur, pertes de bénéfices, trouble commercial, demande ou réclamation de tiers.

En toute hypothèse, la responsabilité de C.G.N. est limitée au montant total HT payé par le Distributeur au titre des Produits considérés.

11.2. Exclusion de responsabilité

La responsabilité de C.G.N. est exclue en cas de préjudice, direct ou indirect, affectant les biens ou les personnes, subi par le Distributeur ou un tiers, notamment les clients du Distributeur, résultant des circonstances visées à l'Article 8, que celles-ci soient le fait du Distributeur ou de tiers.

La responsabilité de C.G.N. ne pourra également en aucun cas être engagée au titre des informations, recommandations ou conseils fournis par le Distributeur à ses clients.

11.3. Besoins du Distributeur

C.G.N. ne pourra en aucun cas être tenue pour responsable des manquements du Distributeur dans la détermination de ses besoins.

12. Propriété intellectuelle - Propriété des résultats

Les droits de propriété intellectuelle attachés aux Produits, incluant notamment les marques, dessins, plans, modèles et brevets, sont la propriété exclusive de C.G.N. ou de ses partenaires. Aucune licence d'utilisation n'est consentie au Distributeur au titre des présentes Conditions Générales de Vente.

13. Dispositions générales

13.1. Non validité partielle

La nullité d'une clause contractuelle n'entraîne pas la nullité des Conditions Générales de Vente, à l'exception de celle d'une clause impulsive et déterminante ayant amené l'une des Parties à contracter.

13.2. Modification des Conditions Générales de Vente

C.G.N. se réserve la faculté de modifier les Conditions Générales de Vente à tout moment. Par conséquent, les Conditions Générales de Vente applicables seront celles en vigueur à la date de la commande par le Distributeur de Produits.

13.3. Force majeure

Les parties ne pourront être tenues responsables si la non-exécution ou le retard dans l'exécution de l'une quelconque de leurs obligations, telles que décrites dans les présentes, découle d'un cas de force majeure, au sens de l'article 1218 du Code civil.

La responsabilité de C.G.N. ne peut pas être engagée en cas d'inexécution ou de mauvaise exécution de ses obligations, qui est due soit au fait d'un tiers, soit à un cas de force majeure.

13.4. Référencement

Le Distributeur accepte que C.G.N. puisse faire figurer les informations relatives à son identification (notamment son nom ou sa dénomination sociale et son adresse) sur son Site Internet ou sur tout document établi aux fins de référencement des Distributeurs proposant des Produits acquis auprès de C.G.N.

13.5. Informatique et libertés

Conformément à l'article 6 de la loi n° 78-17 du 6 janvier 1978 relative à l'informatique, aux fichiers et aux libertés, telle que modifiée, C.G.N. met en œuvre un traitement de données à caractère personnel ayant pour finalité la gestion des commandes des Produits et le référencement des Distributeurs. Les informations qui sont demandées aux Distributeurs sont nécessaires à ces finalités.

13.6. Droit applicable - Juridiction

Les Conditions Générales de Vente sont soumises au droit français.

Les parties s'engagent à tenter de résoudre à l'amiable tout différend relatif à la validité, à l'interprétation, à l'exécution ou la résiliation des présentes susceptible d'intervenir entre elles.

A défaut de règlement amiable dans le délai de trente (30) jours à compter de sa survenance, le litige sera de la compétence exclusive du tribunal compétent dans le ressort du lieu du siège social de C.G.N.

13.7. Fin de vie des produits

CGN est responsable de la fin de vie de ses produits et, à ce titre, remplit son obligation d'adhérer à un éco-organisme concernant la responsabilité élargie du producteur ou metteur sur le marché. Les filières sont :

- Filière des articles de sports et loisirs (ECOLOGIC (n° d'adhérent : FR024751_13UUVZ)
- Filière des piles et batteries (COREPILE) (n° d'adhérent : V 0016)
- Filière des pneumatiques scooter et motos ALIAPUR (n° d'adhérent : C 7485)

NOS MARQUES PROPRES



Motorisé

DOPPLER

Doppler est une marque créée à la fin des années 80 pour la compétition. Elle a réussi à élargir sa gamme en proposant des produits tels que des kits de chaîne, des pignons, mais aussi des équipements pour le moteur comme des casques, des gants et des lunettes.

BLACKWAY
EQUIPEMENTS MOTO

Blackway est la première marque propre de CGN dédiée aux motos et scooters de 125 cm³ et plus. Blackway offre une large gamme de clignotants ainsi qu'une offre diversifiée de poignées, de rétroviseurs, de porte-plaques, de feux arrière, de porte-vignettes d'assurance, etc...

trendy

TRENDY propose des accessoires pour les motards, notamment des gants et des casques. La nouvelle collection offre de nouveaux modèles qui sont mieux conçus, ciblés et segmentés en fonction des différents utilisateurs, avec de meilleures finitions et plus de confort.

Conti
RACING PARTS

Créée par Luigi Conti lui-même dans les années 90, en ciblant le marché des motos, des cyclomoteurs et des scooters de 50 cc, Conti est renommée pour ses kits de cylindres CHR et CRX ainsi que ses pièces de tuning.

TUN'R

Créée en 2005, Tun'R est une marque bien connue dans le monde du tuning de scooters et de motos 50 cc. Elle propose toutes sortes d'accessoires pour personnaliser ou customiser votre véhicule

TEKNIX
Original Racing Controls

Teknix est une marque qui trouve son origine dans les cyclomoteurs et s'est tournée vers les scooters. Les passionnés de tuning apprécieront le prix des pièces Teknix.

Rangers
antivols

Créée en 2004, Rangers est une marque d'accessoires de sécurité pour le cycle et le motorisé. La gamme se compose d'antivols en U de classe SRA, d'antivols à chaîne, de bloque disques, de spirales articulées, de fers à cheval.



MOTEUR

CYCLE

PNEUMATIQUE

ATELIER

ACCESSOIRES

ÉLECTRICITÉ

FILTRATION

FREINAGE

TRANSMISSION



Photos et caractéristiques non contractuelles. Sous réserve d'erreurs typographiques, d'impression ou d'omission. Les caractéristiques techniques peuvent être modifiées sans préavis - Mars 2024.



167, boulevard Salvador Allende - 44812 Saint-Herblain Cedex - France
02 40 92 00 95 - contact@cgntfrance.com - www.cgntfrance.com



Réf. 532392

